

TRENCHSTOP™ Series

Low Loss DuoPack: IGBT in TRENCHSTOP™ and Fieldstop technology with soft, fast recovery antiparallel Emitter Controlled diode

Features:

- Automotive AEC-Q101 qualified
- Designed for DC/AC converters for Automotive Application
- Very low $V_{CE(sat)}$ 1.5V (typ.)
- Maximum junction temperature 175°C
- Dynamically stress tested
- Short circuit withstand time 5 μ s
- 100% short circuit tested
- 100% of the parts are dynamically tested
- Positive temperature coefficient in $V_{CE(sat)}$
- Low EMI
- Low gate charge Q_G
- Green package
- Very soft, fast recovery antiparallel Emitter Controlled HE diode
- TRENCHSTOP™ and Fieldstop technology for 600V applications offers:
 - very tight parameter distribution
 - high ruggedness, temperature stable behavior
 - very high switching speed

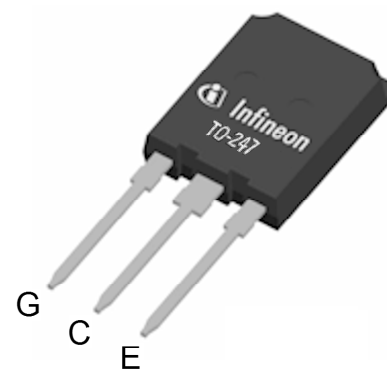
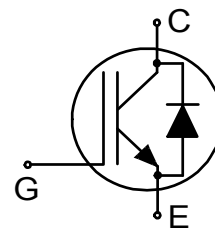

Applications:

- Main inverter
- Climate compressor
- PTC heater
- Motor drives



Key Performance and Package Parameters

Type	V_{CE}	I_C	$V_{CEsat}, T_{vj}=25^\circ\text{C}$	T_{vjmax}	Marking	Package
AIKQ120N60CT	600V	120A	1.5V	175°C	AK120DCT	PG-TO247-3-46



Table of Contents

Description 1

Table of Contents 2

Maximum Ratings 3

Thermal Resistance 3

Electrical Characteristics 4

Electrical Characteristics Diagrams 6

Package Drawing13

Testing Conditions14

Revision History15

Disclaimer16

TRENCHSTOP™ Series

Maximum Ratings

Parameter	Symbol	Value	Unit
Collector-emitter voltage, $T_{vj} \geq 25^{\circ}\text{C}$	V_{CE}	600	V
DC collector current, limited by T_{vjmax} $T_C = 25^{\circ}\text{C}$ value limited by bondwire $T_C = 135^{\circ}\text{C}$	I_C	160.0 120.0	A
Pulsed collector current, t_p limited by T_{vjmax}	I_{Cpuls}	480.0	A
Turn off safe operating area $V_{CE} \leq 600\text{V}$, $T_{vj} \leq 175^{\circ}\text{C}$, $t_p = 1\mu\text{s}$	-	480.0	A
Diode forward current, limited by T_{vjmax} $T_C = 25^{\circ}\text{C}$ value limited by bondwire $T_C = 124^{\circ}\text{C}$	I_F	160.0 120.0	A
Diode pulsed current, t_p limited by T_{vjmax}	I_{Fpuls}	480.0	A
Gate-emitter voltage	V_{GE}	± 20	V
Short circuit withstand time $V_{GE} = 15.0\text{V}$, $V_{CC} \leq 400\text{V}$ Allowed number of short circuits < 1000 Time between short circuits: $\geq 1.0\text{s}$ $T_{vj} = 150^{\circ}\text{C}$	t_{SC}	5	μs
Power dissipation $T_C = 25^{\circ}\text{C}$	P_{tot}	833.0	W
Operating junction temperature	T_{vj}	-40...+175	$^{\circ}\text{C}$
Storage temperature	T_{stg}	-55...+150	$^{\circ}\text{C}$
Soldering temperature, ¹⁾ wave soldering 1.6mm (0.063in.) from case for 10s		260	$^{\circ}\text{C}$

Thermal Resistance

Parameter	Symbol	Conditions	Value			Unit
			min.	typ.	max.	
R_{th} Characteristics						
IGBT thermal resistance, ²⁾ junction - case	$R_{th(j-c)}$		-	-	0.18	K/W
Diode thermal resistance, ²⁾ junction - case	$R_{th(j-c)}$		-	-	0.30	K/W
Thermal resistance junction - ambient	$R_{th(j-a)}$		-	-	40	K/W

¹⁾ Package not recommended for surface mount application

²⁾ Thermal resistance of thermal grease $R_{th(c-s)}$ (case to heat sink) of more than 0.1K/W not included.

TRENCHSTOP™ Series

Electrical Characteristic, at $T_{vj} = 25^{\circ}\text{C}$, unless otherwise specified

Parameter	Symbol	Conditions	Value			Unit
			min.	typ.	max.	
Static Characteristic						
Collector-emitter breakdown voltage	$V_{(BR)CES}$	$V_{GE} = 0\text{V}, I_C = 0.20\text{mA}$	600	-	-	V
Collector-emitter saturation voltage	V_{CEsat}	$V_{GE} = 15.0\text{V}, I_C = 120.0\text{A}$ $T_{vj} = 25^{\circ}\text{C}$ $T_{vj} = 175^{\circ}\text{C}$	- -	1.50 1.90	2.00 -	V
Diode forward voltage	V_F	$V_{GE} = 0\text{V}, I_F = 120.0\text{A}$ $T_{vj} = 25^{\circ}\text{C}$ $T_{vj} = 175^{\circ}\text{C}$	- -	1.65 1.60	2.05 -	V
Gate-emitter threshold voltage	$V_{GE(th)}$	$I_C = 1.90\text{mA}, V_{CE} = V_{GE}$	4.1	4.9	5.7	V
Zero gate voltage collector current	I_{CES}	$V_{CE} = 600\text{V}, V_{GE} = 0\text{V}$ $T_{vj} = 25^{\circ}\text{C}$ $T_{vj} = 175^{\circ}\text{C}$	- -	- 3000	40 -	μA
Gate-emitter leakage current	I_{GES}	$V_{CE} = 0\text{V}, V_{GE} = 20\text{V}$	-	-	100	nA
Transconductance	g_{fs}	$V_{CE} = 20\text{V}, I_C = 120.0\text{A}$	-	75.0	-	S
Integrated gate resistor	r_G			none		Ω

Electrical Characteristic, at $T_{vj} = 25^{\circ}\text{C}$, unless otherwise specified

Parameter	Symbol	Conditions	Value			Unit
			min.	typ.	max.	
Dynamic Characteristic						
Input capacitance	C_{ies}	$V_{CE} = 25\text{V}, V_{GE} = 0\text{V}, f = 1\text{MHz}$	-	7530	-	pF
Output capacitance	C_{oes}		-	446	-	
Reverse transfer capacitance	C_{res}		-	206	-	
Gate charge	Q_G	$V_{CC} = 480\text{V}, I_C = 120.0\text{A},$ $V_{GE} = 15\text{V}$	-	772.0	-	nC
Short circuit collector current Max. 1000 short circuits Time between short circuits: $\geq 1.0\text{s}$	$I_{C(SC)}$	$V_{GE} = 15.0\text{V}, V_{CC} \leq 400\text{V},$ $t_{SC} \leq 5\mu\text{s}$ $T_{vj} = 150^{\circ}\text{C}$	-	846	-	A

Switching Characteristic, Inductive Load

Parameter	Symbol	Conditions	Value			Unit
			min.	typ.	max.	
IGBT Characteristic, at $T_{vj} = 25^{\circ}\text{C}$						
Turn-on delay time	$t_{d(on)}$	$T_{vj} = 25^{\circ}\text{C},$ $V_{CC} = 400\text{V}, I_C = 120.0\text{A},$ $V_{GE} = 0.0/15.0\text{V},$ $R_{G(on)} = 3.0\Omega, R_{G(off)} = 3.0\Omega,$ $L\sigma = 63\text{nH}, C\sigma = 31\text{pF}$ $L\sigma, C\sigma$ from Fig. E Energy losses include "tail" and diode reverse recovery.	-	33	-	ns
Rise time	t_r		-	43	-	ns
Turn-off delay time	$t_{d(off)}$		-	310	-	ns
Fall time	t_f		-	33	-	ns
Turn-on energy	E_{on}		-	4.10	-	mJ
Turn-off energy	E_{off}		-	2.80	-	mJ
Total switching energy	E_{ts}		-	6.90	-	mJ

TRENCHSTOP™ Series

Diode Characteristic, at $T_{vj} = 25^{\circ}\text{C}$

Diode reverse recovery time	t_{rr}	$T_{vj} = 25^{\circ}\text{C}$, $V_R = 400\text{V}$, $I_F = 120.0\text{A}$, $di_F/dt = 1100\text{A}/\mu\text{s}$	-	280	-	ns
Diode reverse recovery charge	Q_{rr}		-	3.50	-	μC
Diode peak reverse recovery current	I_{rrm}		-	25.0	-	A
Diode peak rate of fall of reverse recovery current during t_b	di_{rr}/dt		-	-500	-	$\text{A}/\mu\text{s}$

Switching Characteristic, Inductive Load

Parameter	Symbol	Conditions	Value			Unit
			min.	typ.	max.	

IGBT Characteristic, at $T_{vj} = 175^{\circ}\text{C}$

Turn-on delay time	$t_{d(on)}$	$T_{vj} = 175^{\circ}\text{C}$, $V_{CC} = 400\text{V}$, $I_C = 120.0\text{A}$, $V_{GE} = 0.0/15.0\text{V}$, $R_{G(on)} = 3.0\Omega$, $R_{G(off)} = 3.0\Omega$, $L\sigma = 63\text{nH}$, $C\sigma = 31\text{pF}$ $L\sigma$, $C\sigma$ from Fig. E Energy losses include "tail" and diode reverse recovery.	-	33	-	ns
Rise time	t_r		-	51	-	ns
Turn-off delay time	$t_{d(off)}$		-	355	-	ns
Fall time	t_f		-	43	-	ns
Turn-on energy	E_{on}		-	6.70	-	mJ
Turn-off energy	E_{off}		-	4.10	-	mJ
Total switching energy	E_{ts}		-	10.80	-	mJ

Diode Characteristic, at $T_{vj} = 175^{\circ}\text{C}$

Diode reverse recovery time	t_{rr}	$T_{vj} = 175^{\circ}\text{C}$, $V_R = 400\text{V}$, $I_F = 120.0\text{A}$, $di_F/dt = 1000\text{A}/\mu\text{s}$	-	410	-	ns
Diode reverse recovery charge	Q_{rr}		-	10.80	-	μC
Diode peak reverse recovery current	I_{rrm}		-	45.0	-	A
Diode peak rate of fall of reverse recovery current during t_b	di_{rr}/dt		-	-520	-	$\text{A}/\mu\text{s}$

TRENCHSTOP™ Series

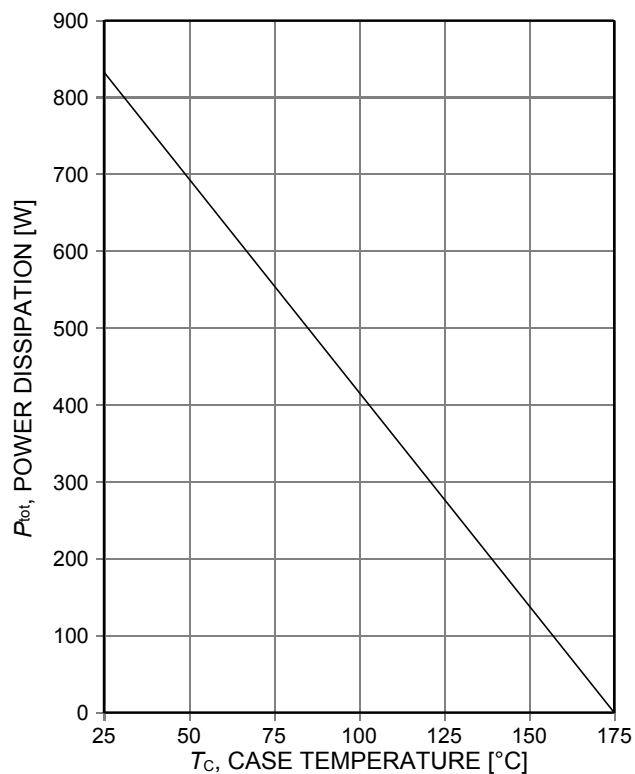

Figure 1. Power dissipation as a function of case temperature ($T_j \leq 175^\circ\text{C}$)

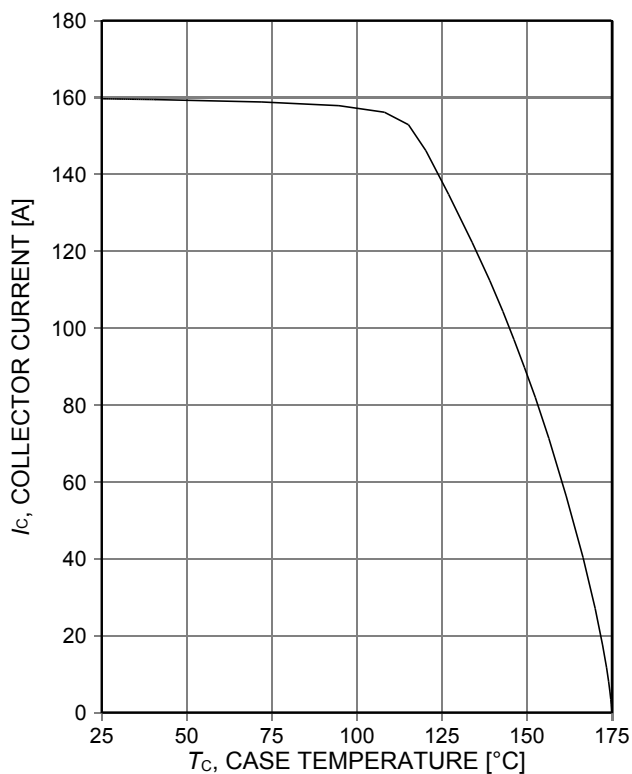

Figure 2. Collector current as a function of case temperature ($V_{GE} \geq 15\text{V}$, $T_j \leq 175^\circ\text{C}$)

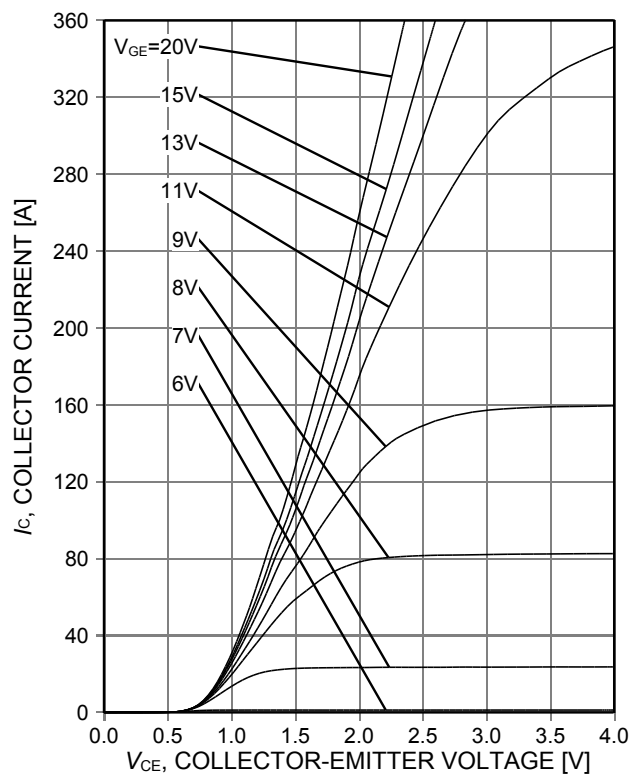

Figure 3. Typical output characteristic ($T_j = 25^\circ\text{C}$)

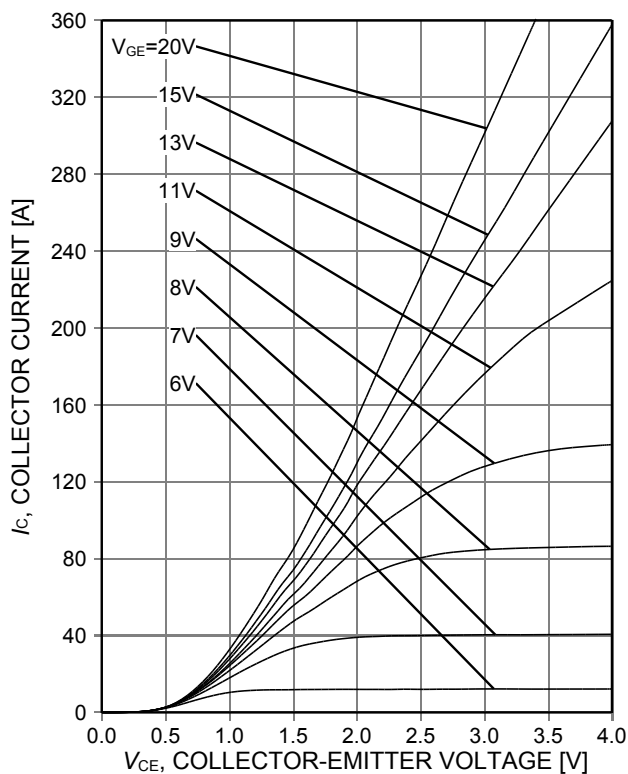

Figure 4. Typical output characteristic ($T_j = 175^\circ\text{C}$)

TRENCHSTOP™ Series

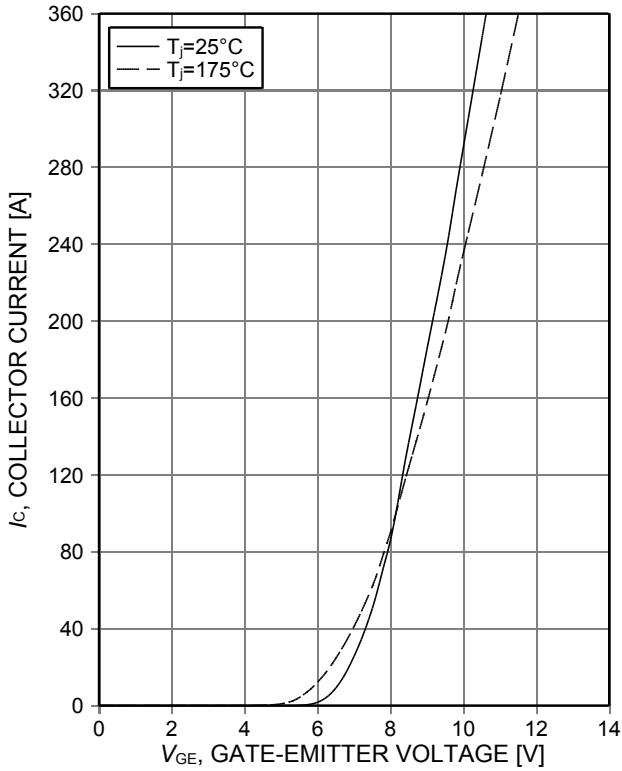

Figure 5. **Typical transfer characteristic**
($V_{CE}=20V$)

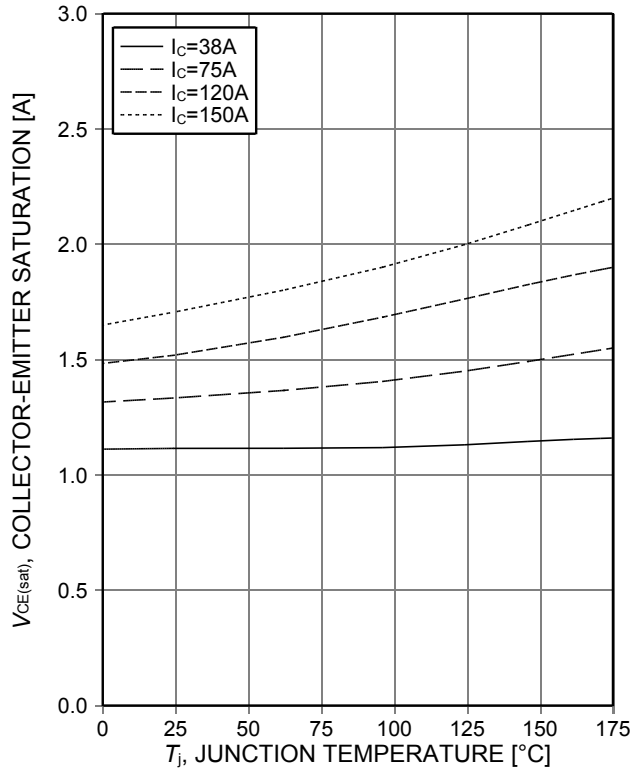

Figure 6. **Typical collector-emitter saturation voltage as a function of junction temperature**
($V_{GE}=15V$)

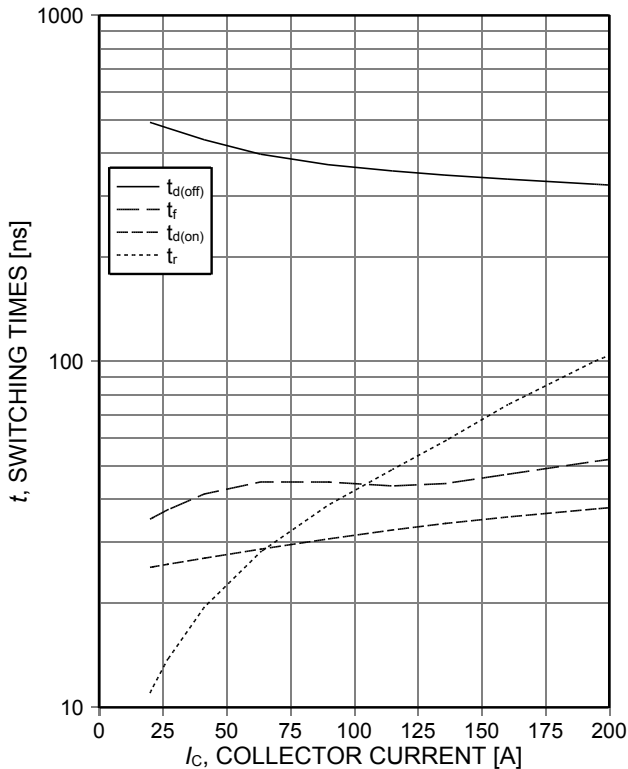

Figure 7. **Typical switching times as a function of collector current**
(inductive load, $T_j=175^\circ C$, $V_{CE}=400V$, $V_{GE}=15/0V$, $r_G=3\Omega$, Dynamic test circuit in Figure E)

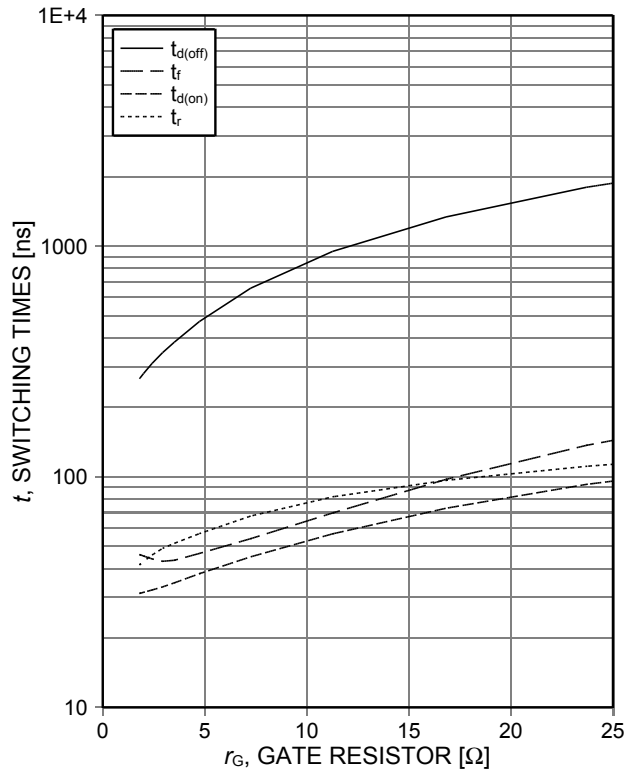

Figure 8. **Typical switching times as a function of gate resistor**
(inductive load, $T_j=175^\circ C$, $V_{CE}=400V$, $V_{GE}=15/0V$, $I_C=120A$, Dynamic test circuit in Figure E)

TRENCHSTOP™ Series

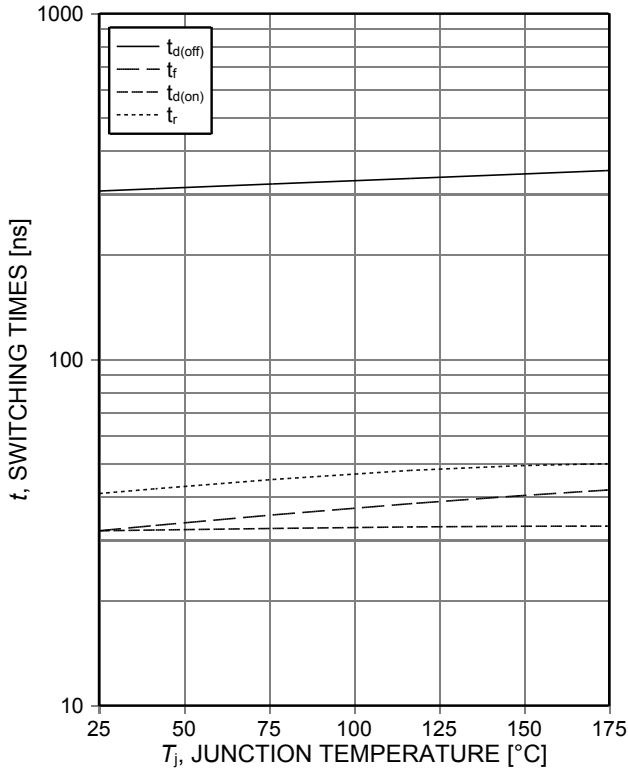

Figure 9. Typical switching times as a function of junction temperature (inductive load, $V_{CE}=400V$, $V_{GE}=15/0V$, $I_C=120A$, $r_G=3\Omega$, Dynamic test circuit in Figure E)

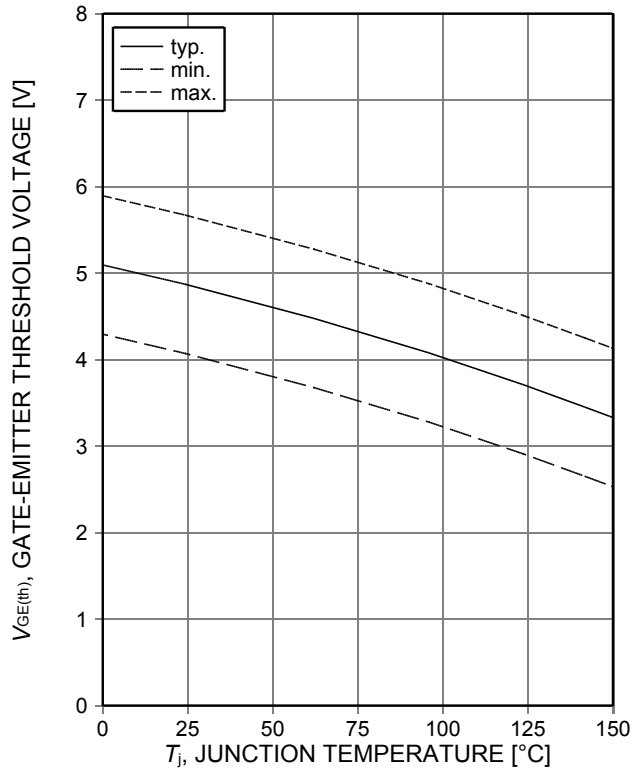

Figure 10. Gate-emitter threshold voltage as a function of junction temperature ($I_C=1,9mA$)

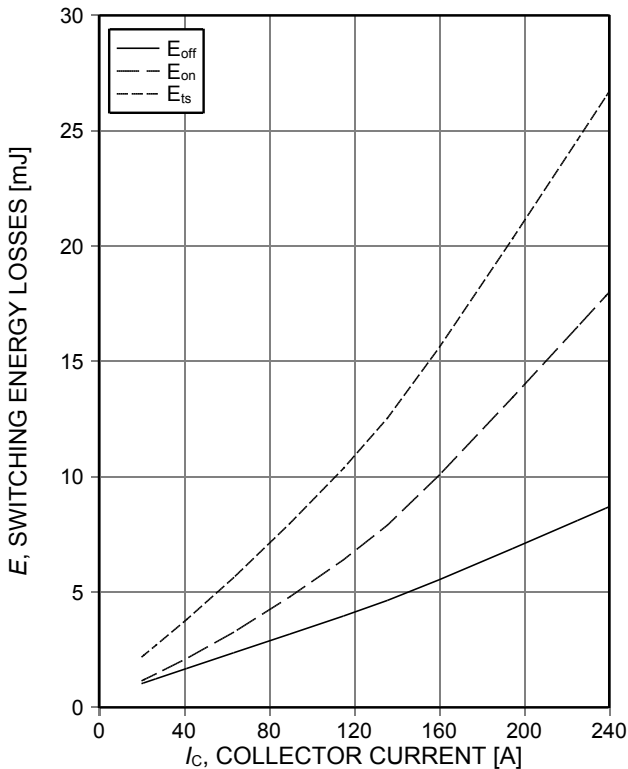

Figure 11. Typical switching energy losses as a function of collector current (inductive load, $T_j=175^\circ C$, $V_{CE}=400V$, $V_{GE}=15/0V$, $r_G=3\Omega$, Dynamic test circuit in Figure E)

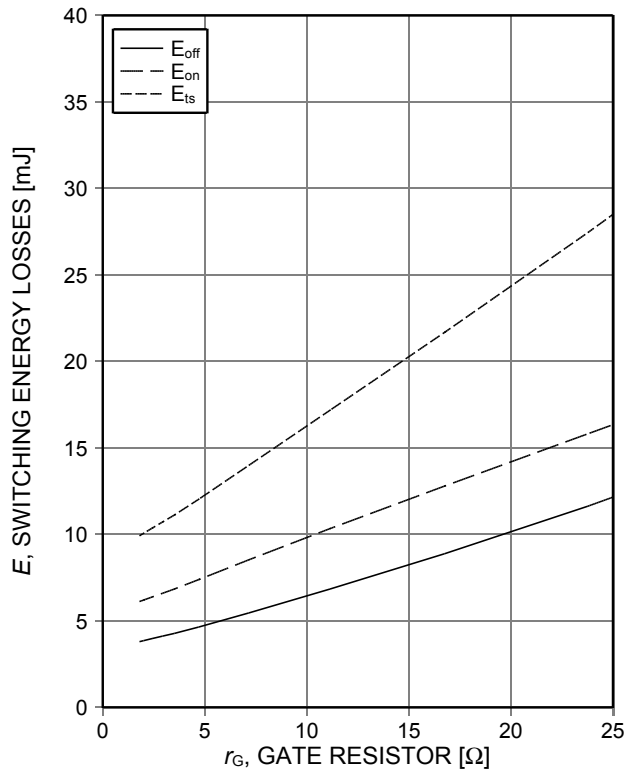

Figure 12. Typical switching energy losses as a function of gate resistor (inductive load, $T_j=175^\circ C$, $V_{CE}=400V$, $V_{GE}=15/0V$, $I_C=120A$, Dynamic test circuit in Figure E)

TRENCHSTOP™ Series

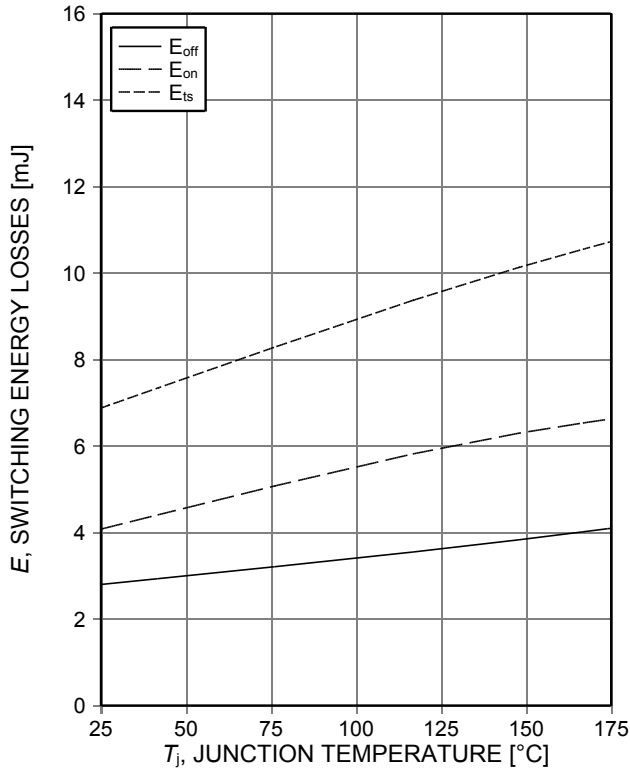

Figure 13. **Typical switching energy losses as a function of junction temperature** (inductive load, $V_{CE}=400V$, $V_{GE}=15/0V$, $I_C=120A$, $r_G=3\Omega$, Dynamic test circuit in Figure E)

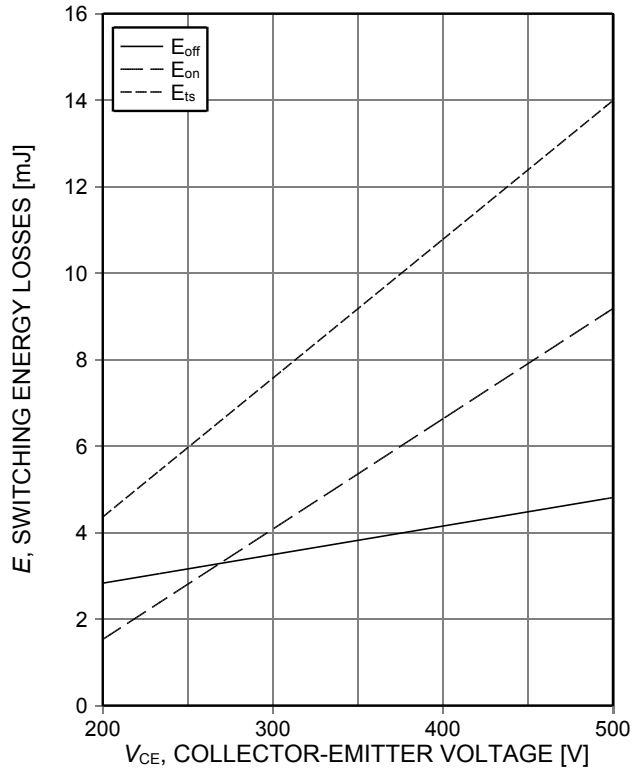

Figure 14. **Typical switching energy losses as a function of collector emitter voltage** (inductive load, $T_j=175^\circ C$, $V_{GE}=15/0V$, $I_C=120A$, $R_G=3\Omega$, Dynamic test circuit in Figure E)

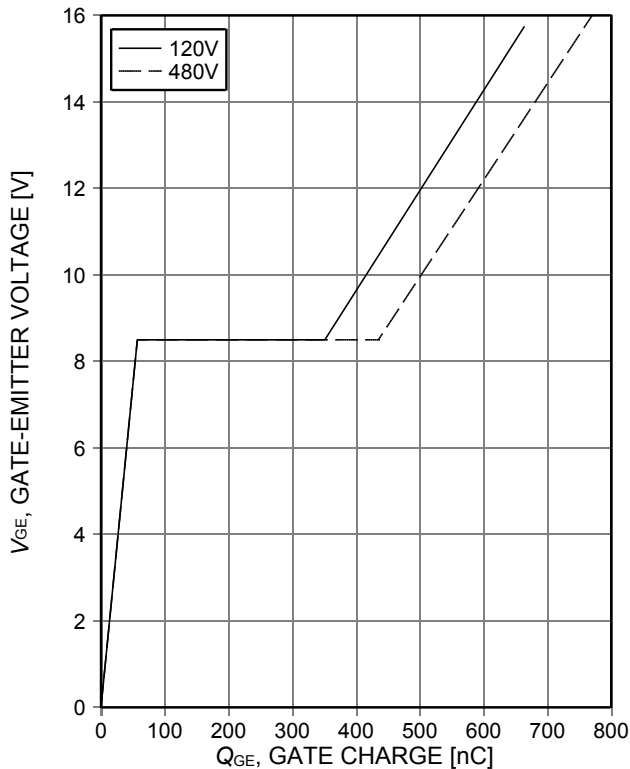

Figure 15. **Typical gate charge** ($I_C=120A$)

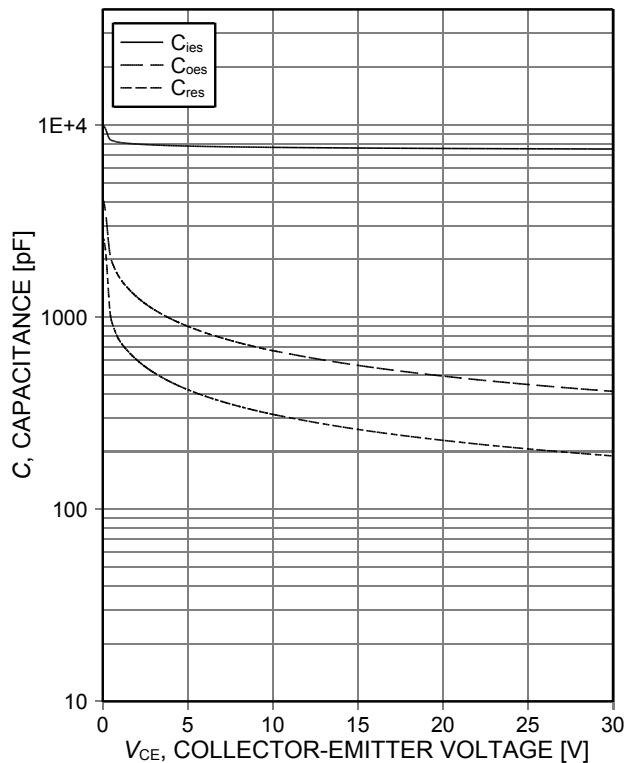

Figure 16. **Typical capacitance as a function of collector-emitter voltage** ($V_{GE}=0V$, $f=1MHz$)

TRENCHSTOP™ Series

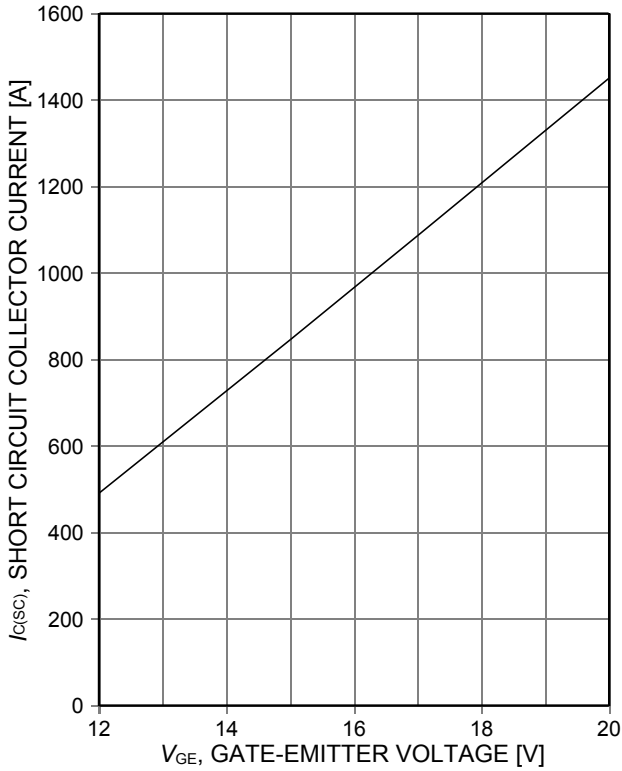

Figure 17. Typical short circuit collector current as a function of gate-emitter voltage ($V_{CE} \leq 400V$, start at $T_j \leq 150^\circ C$)

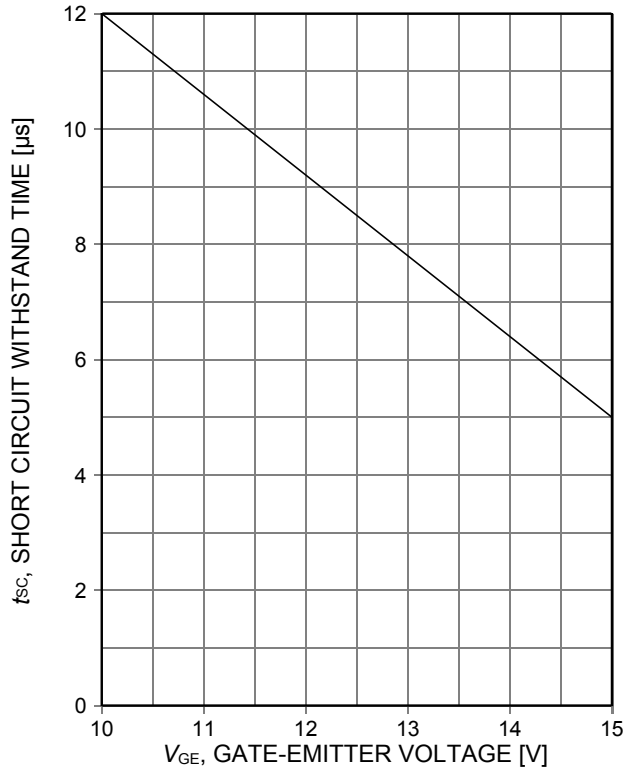

Figure 18. Short circuit withstand time as a function of gate-emitter voltage ($V_{CE} = 400V$, start at $T_j = 25^\circ C$, $T_{jmax} \leq 150^\circ C$)

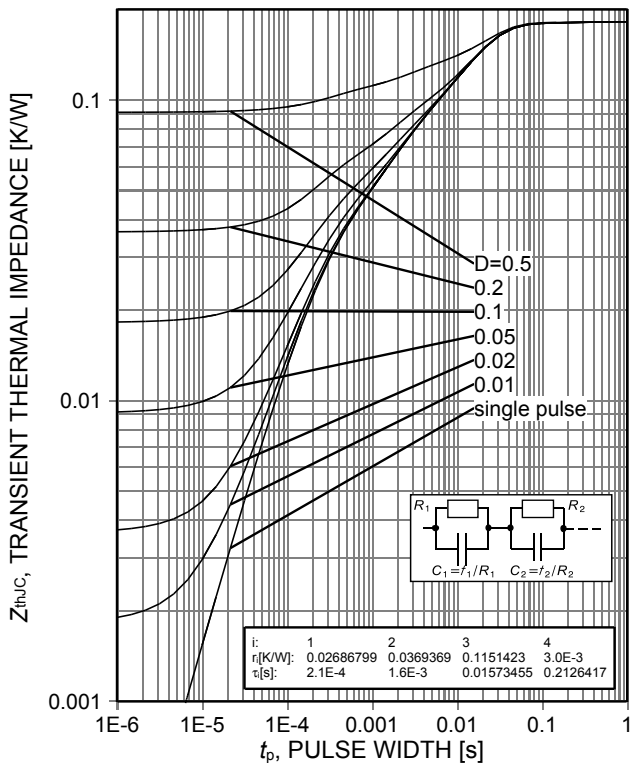

Figure 19. IGBT transient thermal impedance as a function of pulse width for different duty cycles D ($D = t_p/T$)

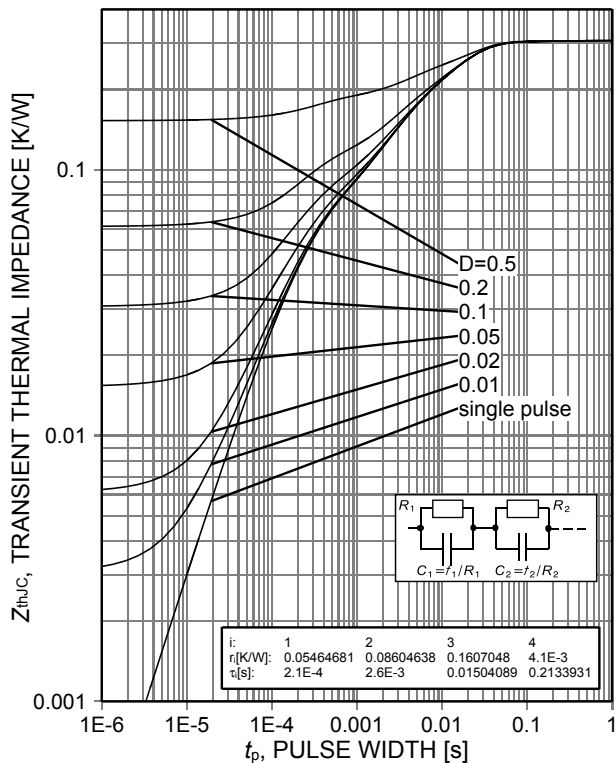

Figure 20. Diode transient thermal impedance as a function of pulse width for different duty cycles D ($D = t_p/T$)

TRENCHSTOP™ Series

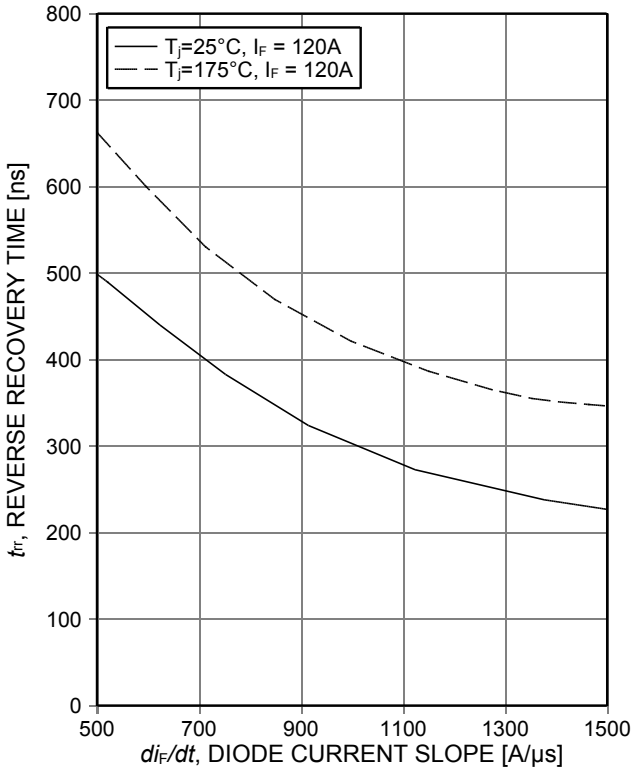

Figure 21. **Typical reverse recovery time as a function of diode current slope**
($V_R=400V$, Dynamic test circuit in Figure E)

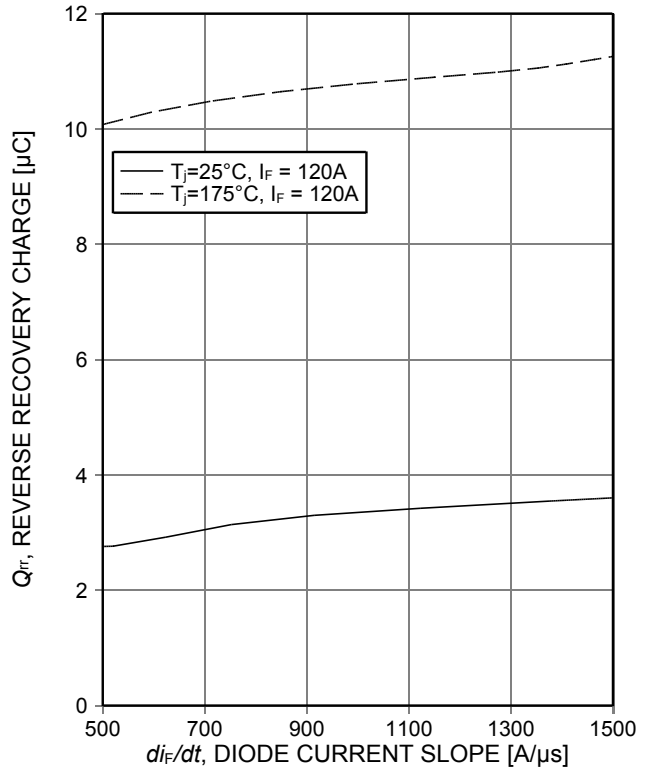

Figure 22. **Typical reverse recovery charge as a function of diode current slope**
($V_R=400V$, Dynamic test circuit in Figure E)

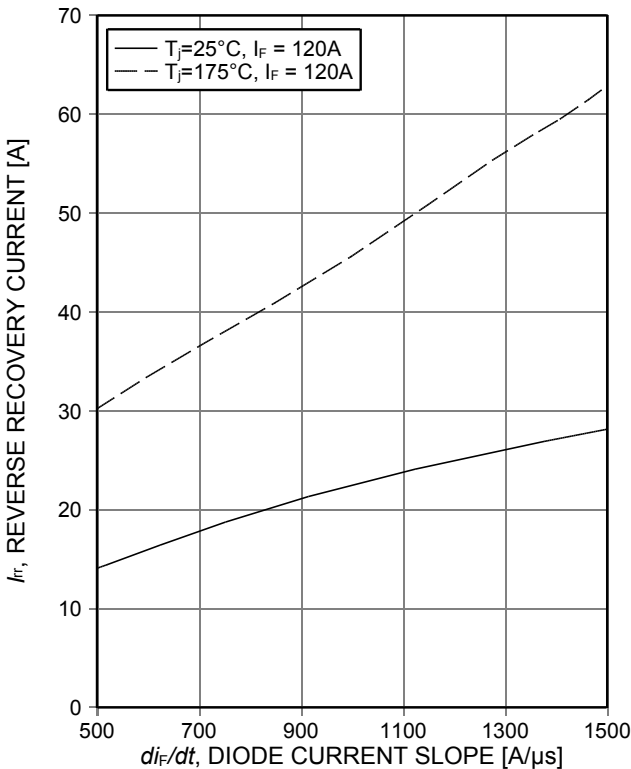

Figure 23. **Typical reverse recovery current as a function of diode current slope**
($V_R=400V$, Dynamic test circuit in Figure E)

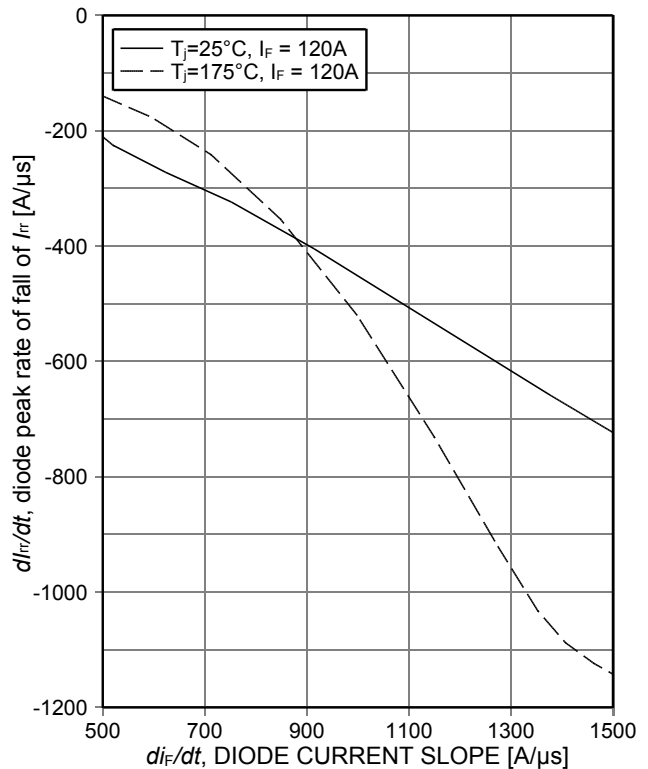

Figure 24. **Typical diode peak rate of fall of reverse recovery current as a function of diode current slope**
($V_R=400V$, Dynamic test circuit in Figure E)

TRENCHSTOP™ Series

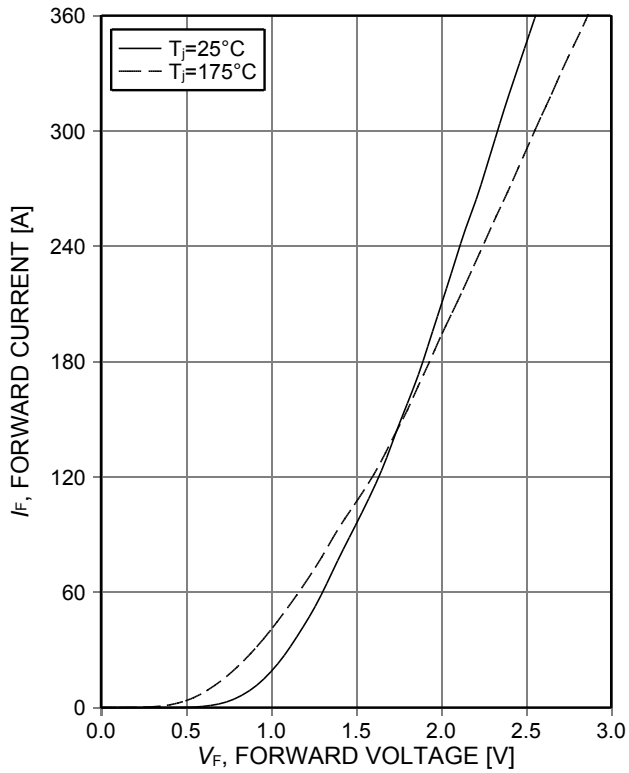

Figure 25. Typical diode forward current as a function of forward voltage

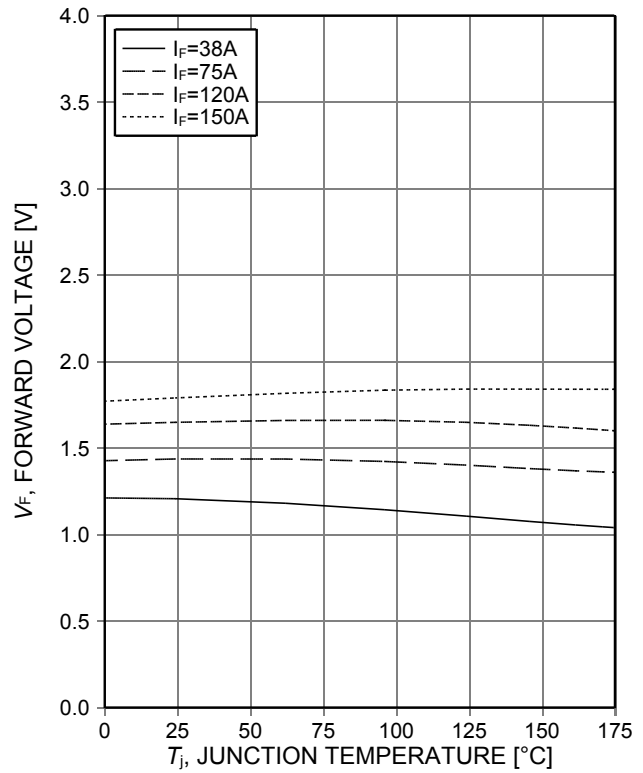
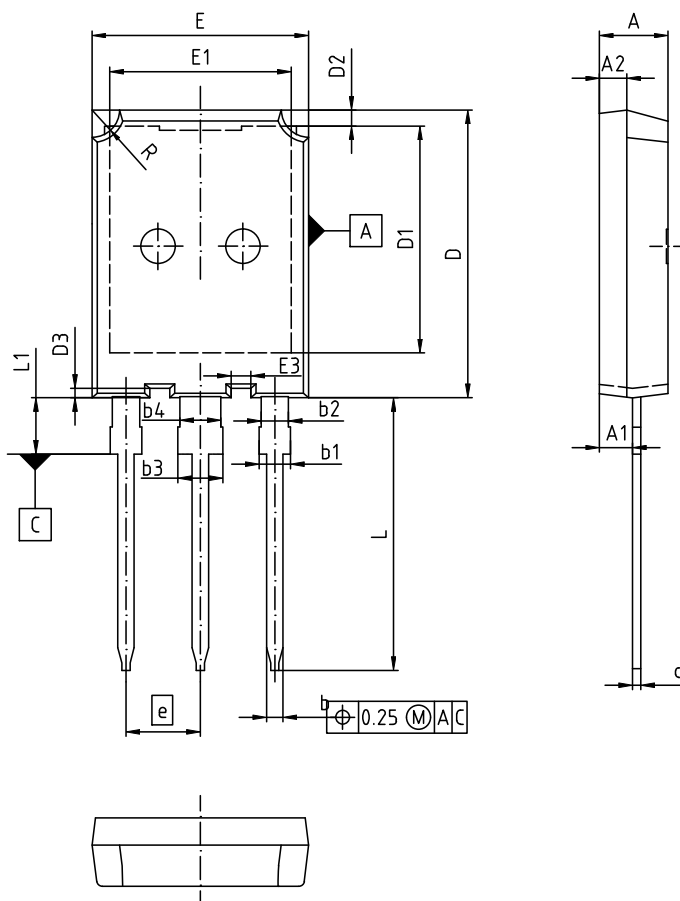

Figure 26. Typical diode forward voltage as a function of junction temperature

Package Drawing PG-TO247-3-46



DIM	MILLIMETERS		INCHES	
	MIN	MAX	MIN	MAX
A	4.90	5.10	0.193	0.201
A1	2.31	2.51	0.091	0.099
A2	1.90	2.10	0.075	0.083
b	1.16	1.26	0.046	0.050
b1	1.96	2.25	0.077	0.089
b2	1.96	2.06	0.077	0.081
c	0.59	0.66	0.023	0.026
D	20.90	21.10	0.823	0.831
D1	16.25	16.85	0.640	0.663
D2	1.05	1.35	0.041	0.053
D3	0.58	0.78	0.023	0.031
E	15.70	15.90	0.618	0.626
E1	13.10	13.50	0.516	0.531
E3	1.35	1.55	0.053	0.061
e	5.44 (BSC)		0.214 (BSC)	
N	3		3	
L	19.80	20.10	0.780	0.791
L1	-	4.30	-	0.169
R	1.90	2.10	0.075	0.083

DOCUMENT NO.
Z8B00174295

SCALE

EUROPEAN PROJECTION

ISSUE DATE
13-08-2014

REVISION
01

Testing Conditions

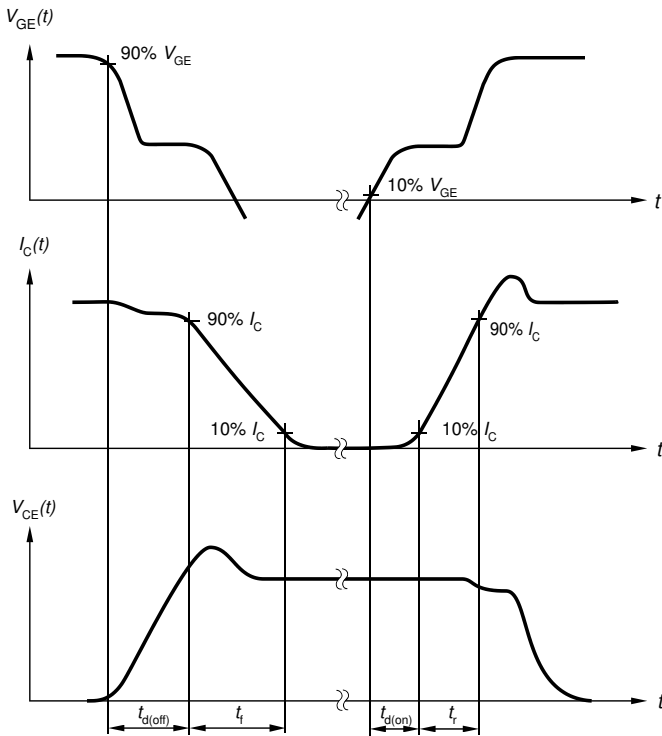

Figure A. Definition of switching times

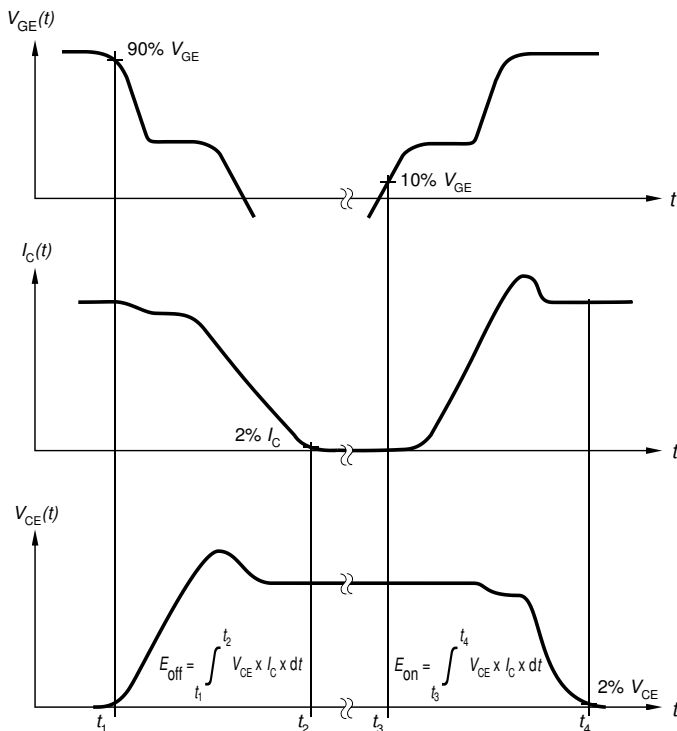

Figure B. Definition of switching losses

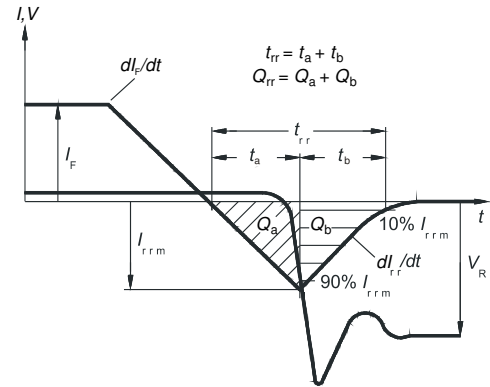

Figure C. Definition of diode switching characteristics

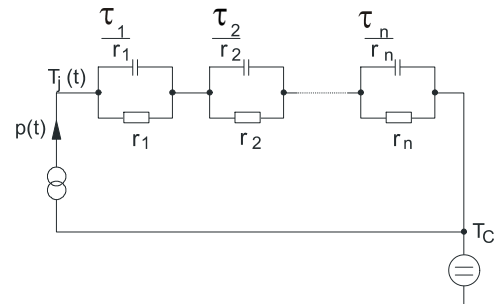

Figure D. Thermal equivalent circuit

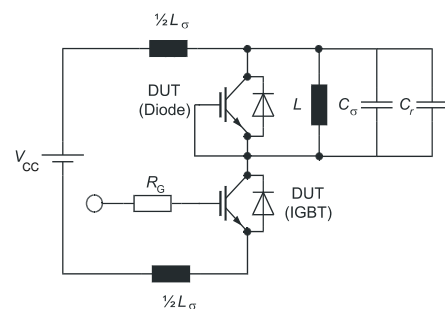

Figure E. Dynamic test circuit
Parasitic inductance L_{σ} ,
parasitic capacitor C_{σ} ,
relief capacitor C_r ,
(only for ZVT switching)

Revision History

AIKQ120N60CT

Revision: 2017-02-09, Rev. 2.1

Previous Revision

Revision	Date	Subjects (major changes since last revision)
2.1	2017-02-09	Data sheet created