



User Manual

AIMB-581

**Intel® Core™ i7/i5/i3/Celeron
and Xeon-E3 LGA1155 Micro
ATX with VGA/DVI/LVDS, 6 COM,
Dual Lan, 4 SATA II, 2 SATA III,
PCIe x 16**

ADVANTECH

Enabling an Intelligent Planet

Copyright

The documentation and the software included with this product are copyrighted 2011 by Advantech Co., Ltd. All rights are reserved. Advantech Co., Ltd. reserves the right to make improvements in the products described in this manual at any time without notice.

No part of this manual may be reproduced, copied, translated or transmitted in any form or by any means without the prior written permission of Advantech Co., Ltd. Information provided in this manual is intended to be accurate and reliable. However, Advantech Co., Ltd. assumes no responsibility for its use, nor for any infringements of the rights of third parties, which may result from its use.

Acknowledgements

AMI is a trademark of Phoenix Technologies Ltd.

IBM and PC are trademarks of International Business Machines Corporation.

Intel® Core™ i7/i5/i3 Celeron® is trademark of Intel Corporation

WinBond is a trademark of Winbond Corporation.

All other product names or trademarks are properties of their respective owners.

A Message to the Customer

Advantech Customer Services

Each and every Advantech product is built to the most exacting specifications to ensure reliable performance in the harsh and demanding conditions typical of industrial environments. Whether your new Advantech equipment is destined for the laboratory or the factory floor, you can be assured that your product will provide the reliability and ease of operation for which the name Advantech has come to be known.

Your satisfaction is our primary concern. Here is a guide to Advantech's customer services. To ensure you get the full benefit of our services, please follow the instructions below carefully.

Technical Support

We want you to get the maximum performance from your products. So if you run into technical difficulties, we are here to help. For the most frequently asked questions, you can easily find answers in your product documentation. These answers are normally a lot more detailed than the ones we can give over the phone.

So please consult this manual first. If you still cannot find the answer, gather all the information or questions that apply to your problem, and with the product close at hand, call your dealer. Our dealers are well trained and ready to give you the support you need to get the most from your Advantech products. In fact, most problems reported are minor and are able to be easily solved over the phone.

In addition, free technical support is available from Advantech engineers every business day. We are always ready to give advice on application requirements or specific information on the installation and operation of any of our products.

Declaration of Conformity

FCC Class B

This device complies with the requirements in part 15 of the FCC rules:

Operation is subject to the following two conditions:

- This device may not cause harmful interference
- This device must accept any interference received, including interference that may cause undesired operation.

This equipment has been tested and found to comply with the limits for a Class B digital device, pursuant to Part 15 of the FCC Rules. These limits are designed to provide reasonable protection against harmful interference when the equipment is operated in a commercial environment. This equipment generates, uses, and can radiate radio frequency energy and, if not installed and used in accordance with the instruction manual, may cause harmful interference to radio communications. Operation of this device in a residential area is likely to cause harmful interference in which case the user will be required to correct the interference at his/her own expense. The user is advised that any equipment changes or modifications not expressly approved by the party responsible for compliance would void the compliance to FCC regulations and therefore, the user's authority to operate the equipment.

Caution! *There is a danger of a new battery exploding if it is incorrectly installed. Do not attempt to recharge, force open, or heat the battery. Replace the battery only with the same or equivalent type recommended by the manufacturer. Discard used batteries according to the manufacturer's instructions.*



CPU Compatibility

Test Item	Description										Result	Remark
	CPU Family	sSpec.	Core Stepping	Power	Vcore	FSB	Mfg. Tech	HT	L2 cache	L3 cache		
Intel® Core™ i3-2120 Processor 3.3 GHz	SR05Y	Q0	65W		5 GT/s	32nm	NA	NA	3MB	LGA1155	PASS	
Intel® Core™ i5-2400 Processor 3.1GHz	SR00Q	D2	95W		5 GT/s	32nm	NA	NA	6MB	LGA1155	PASS	
Intel® Core™ i7-2600 Processor 3.4 GHz	SR00B	D2	95W		5 GT/s	32nm	NA	NA	8B	LGA1155	PASS	

Memory Compatibility

Test Item	Description						Result	Remark
Brand	Size	Speed	Type	ECC	Vendor PN	Memory		
Transcend	1GB	DDR3 1066	DDR3	N	TS128MLK64V1U/ TS2KNU28100-1S	SEC K4B1G0846D-HCF8 (128x8)	PASS	
	1GB	DDR3 1066	DDR3	N	TS128MLK64V1U	SEC K4B1G0846D HCH9 ENJ038A3 (128x8)	PASS	
	2GB	DDR3 1066	DDR3	N	TS256MLK64V1U	SEC K4B1G0846D-HCF9(128x8)	PASS	
Apacer	1GB	DDR3 1066	DDR3	N	78.01GC3.420	ELPIDA J1108BDBG-DJ-F (128x8)	PASS	
	2GB	DDR3 1066	DDR3	N	78.A1GC3.421	ELPIDA J1108BDBG-DJ-F (128x8)	PASS	
	4GB	DDR3 1066	DDR3	N	78.B1GDJ.AF1	Hynix H5TQ2G83AFR H9C (256x8)	PASS	
DSL	1GB	DDR3 1066	DDR3	N	D3UE28081XH18AB	ELPIDA J1108BDSE-DJ-F (128x8)	PASS	
	2GB	DDR3 1066	DDR3	N	D3UE28082XH18AB	ELPIDA J1108BDSE-DJ-F (128x8)	PASS	
ATP	4GB	DDR3 1066	DDR3	N	AQ12M64B8BKF8S	SAMSUNG 940 K4B2G0846B- HCF8 (256x8)	PASS	
Transcend	1GB	DDR3 1333	DDR3	N	TS128MLK64V3U	ELPIDA J1108BDBG-DJ-F(128x8)	PASS	
	1GB	DDR3 1333	DDR3	N	TS128MLK64V3U	Micron 9GF22 D9KPT (128x8)	PASS	
	2GB	DDR3 1333	DDR3	N	TS256MLK64V3U	SEC 907 HCH9 K4B1G08460(128x8)	PASS	
Apacer	1GB	DDR3 1333	DDR3	N	78.01GC6.420	ELPIDA J1108BFBG-DJ-F(128x8)	PASS	
	2GB	DDR3 1333	DDR3	N	78.A1GC6.421	ELPIDA J1108BDBG-DJ-F (128x8)	PASS	
	2GB	DDR3 1333	DDR3	N	78.A1GDE.AF00C	Hynix H5TQ2G838FR(256x8)	PASS	
	4GB	DDR3 1333	DDR3	N	78.B1GDE.AF1	Hynix H5TQ2G83AFR H9C(256x8)	PASS	
DSL	1GB	DDR3 1333	DDR3	N	D3UE28081XH18AB	ELPIDA J1108BDSE-DJ-F (128x8)	PASS	
	2GB	DDR3 1333	DDR3	N	D3UE28082XH18AB	ELPIDA J1108BDSE-DJ-F (128x8)	PASS	
Kingston	1GB	DDR3 1333	DDR3	N	KVR1333D3N9/1G	HYNIX H5TQ1G83BFR H9C 928AK (128x8)	PASS	
	2GB	DDR3 1333	DDR3	N	TS128MLK64V3U	ELPIDA J1108BDBG-DJ-F 093309DLK20 (256x8)	PASS	
ATP	4GB	DDR3 1333	DDR3	N	AQ12M64B8BKH9S	SAMSUNG 949 K4B2G0846B- HCH9 (256x8)	PASS	

Ordering Information

Part Number	Chipset	Memory	USB 3.0	VGA	DVI1/2	LVDS	USB	COM	TPM	GbE LAN
AIMB-581QG2-00A1E	Q67	Non-ECC	2	Yes	1/(1)	(1)	12	6	(1)	2
AIMB-581WG2-00A1E	C206	ECC/ Non-ECC	2	Yes	1/(1)	(1)	12	6	(1)	2

*() means do not populated on MP version.

Product Warranty (2 years)

Advantech warrants to you, the original purchaser, that each of its products will be free from defects in materials and workmanship for two years from the date of purchase.

This warranty does not apply to any products which have been repaired or altered by persons other than repair personnel authorized by Advantech, or which have been subject to misuse, abuse, accident or improper installation. Advantech assumes no liability under the terms of this warranty as a consequence of such events.

Because of Advantech's high quality-control standards and rigorous testing, most of our customers never need to use our repair service. If an Advantech product is defective, it will be repaired or replaced at no charge during the warranty period. For out-of-warranty repairs, you will be billed according to the cost of replacement materials, service time and freight. Please consult your dealer for more details.

If you think you have a defective product, follow these steps:

1. Collect all the information about the problem encountered. (For example, CPU speed, Advantech products used, other hardware and software used, etc.) Note anything abnormal and list any onscreen messages you get when the problem occurs.
2. Call your dealer and describe the problem. Please have your manual, product, and any helpful information readily available.
3. If your product is diagnosed as defective, obtain an RMA (return merchandise authorization) number from your dealer. This allows us to process your return more quickly.
4. Carefully pack the defective product, a fully-completed Repair and Replacement Order Card and a photocopy proof of purchase date (such as your sales receipt) in a shippable container. A product returned without proof of the purchase date is not eligible for warranty service.
5. Write the RMA number visibly on the outside of the package and ship it prepaid to your dealer.

Initial Inspection

Before you begin installing your motherboard, please make sure that the following materials have been shipped:

- 1 x AIMB-581 Intel Xeon-E3 and Core i7/i5/i3/Celeron LGA 1155 Micro ATX
- 2 x SATA HDD cable
- 2 x SATA Power cable
- 1 x I/O port bracket
- 1 x Startup manual
- 1 x Driver CD
- 1 x Warranty card

If any of these items are missing or damaged, contact your distributor or sales representative immediately. We have carefully inspected the AIMB-581 mechanically and electrically before shipment. It should be free of marks and scratches and in perfect working order upon receipt. As you unpack the AIMB-581, check it for signs of shipping damage. (For example, damaged box, scratches, dents, etc.) If it is damaged or it fails to meet the specifications, notify our service department or your local sales representative immediately. Also notify the carrier. Retain the shipping carton and packing material for inspection by the carrier. After inspection, we will make arrangements to repair or replace the unit.

Contents

Chapter 1 General Information1

1.1	Introduction	2
1.2	Features	2
1.3	Specifications	2
1.3.1	System	2
1.3.2	Memory	2
1.3.3	Input/Output	3
1.3.4	Graphics.....	3
1.3.5	Ethernet LAN	3
1.3.6	Industrial features	3
1.3.7	Mechanical and environmental specifications.....	3
1.4	Jumpers and Connectors	4
	Table 1.1: Jumpers.....	4
	Table 1.2: Connectors	4
1.5	Board layout: Jumper and Connector Locations	5
	Figure 1.1 Jumper and Connector Location	5
	Figure 1.2 I/O Connectors	6
1.6	AIMB-581 Board Diagram	6
	Figure 1.3 AIMB-581 Board Diagram	6
1.7	Safety Precautions	7
1.8	Jumper Settings	7
1.8.1	How to Set Jumpers.....	7
1.8.2	CMOS Clear (CMOS1)	8
	Table 1.3: CMOS1	8
1.8.3	JLVDS1: LCD Power 3.3 V/5 V/ 12 V Selector	8
	Table 1.4: JLVDS1: LCD Power 3.3 V/5 V/ 12 V Selector.....	8
1.8.4	JLVDS_CLT1: Backlight control selector for LVDS1	9
	Table 1.5: JLVDS_CLT1: Backlight control selector for LVDS1 ..	9
1.8.5	PSON1: ATX, AT Mode Selector	9
	Table 1.6: PSON1: ATX, AT Mode Selector.....	9
1.8.6	JWDT1+JOBS1: Watchdog Timer Output and OBS Alarm Option.	9
	Table 1.7: JWDT1+JOBS1: Watchdog Timer Output and OBS	9
	Alarm Option.....	9
1.8.7	JME1:BIOS Update ME Mode Selector	10
	Table 1.8: BIOS update ME mode selector	10
1.8.8	JCASE1: Case Open Sensor.....	10
1.9	System Memory	10
1.10	Memory Installation Procedures.....	11
1.11	Cache Memory.....	11
1.12	Processor Installation	11
1.13	PCI Bus Routing Table.....	11

Chapter 2 Connecting Peripherals13

2.1	Introduction	14
2.2	USB Ports (LAN1_USB12/LAN2_USB34/USB56/USB78)	14
	Table 2.1: LAN LED Indicator.....	14
2.3	USB Power Switch	15
2.4	VGA/DVI-D Connector(VGA1+DVI1), DVI2 Connector.....	16
2.5	Serial Ports (COM1~COM6)	17
2.6	PS/2 Keyboard and Mouse Connector (KBMS1)/External PS/2 Keyboard	18
	and Mouse Connector(KBMS2)	18
2.7	CPU Fan Connector (CPU_FAN1).....	19

2.8	System FAN Connector (SYSFAN1/2/3/4)	19
2.9	Front Panel Connectors (JFP1/JFP2/JFP3)	20
2.9.1	ATX soft power switch ((JFP1/PWR_SW)).....	20
2.9.2	Reset (JFP1/RESET).....	20
2.9.3	HDD LED (JFP1/HDDLED)	20
2.9.4	External speaker (JFP1/SPEAKER).....	20
2.9.5	Power LED and keyboard lock connector (JFP3/PWR_LED & KEY LOCK).....	21
	Table 2.2: ATX power supply LED status (No support for AT power)	21
2.10	Line In, Line Out, Mic In Connector (AUDIO1).....	21
2.11	Digital Audio Connector (SPDIF_OUT1).....	22
2.12	Serial ATA Interface (SATA1 ~ SATA6).....	23
2.13	8-pin Alarm Board Connector(VOLT1).....	24
2.14	PCI express x16 slot	24
2.15	Front Headphone Connector (FPAUD1).....	25
2.16	ATX Power Connector (EATXPWR1, ATX12V1).....	26
2.17	SPI Flash connector(SPI_CN1)	27
2.18	LCD Inverter Connector (INV1).....	28
2.19	LVDS Connector (LVDS1)	29
2.20	General purpose I/O Connector (GPIO1)	29

Chapter 3 BIOS Operation 31

3.1	Introduction	32
3.2	BIOS Setup	32
3.3	Main Menu	33
3.3.1	Advanced BIOS Features	34
3.3.2	ACPI settings	35
3.3.3	CPU Configuration.....	36
3.3.4	SATA Configuration	37
3.3.5	Intel TXT Configuration.....	38
3.3.6	USB Configuration	39
3.3.7	Super IO Configuration	40
3.3.8	H/W Monitor	45
3.3.9	Intelligent Power Sharing.....	46
3.3.10	AMT Configuration.....	46
3.3.11	Switchable Graphics	50
3.4	Chipset Configuration Setting	51
3.4.1	PCH-IO Configuration.....	51
3.4.2	North Bridge Configuration	52
3.4.3	South Bridge Configuration.....	55
3.4.4	PCI Express Ports Configuration	56
3.4.5	USB Configuration	60
3.5	Boot Setting	61
3.6	Security Setting.....	62
3.7	Save & Exit Configuration	63

Chapter 4 Software Introduction & Service 65

4.1	Introduction	66
4.2	Value-Added Software Services	66
4.2.1	Software API.....	66
4.2.2	Software Utility.....	68

Chapter 5 Chipset Software Installation Utility 69

5.1	Before You Begin.....	70
-----	-----------------------	----

5.2	Introduction	70
5.3	Windows XP/Windows 7 Driver Setup	71

Chapter 6 **VGA Setup.....73**

6.1	Introduction	74
6.2	Windows 7/XP	74

Chapter 7 **LAN Configuration.....77**

7.1	Introduction	78
7.2	Features	78
7.3	Installation	78
7.4	Windows® 7/XP Driver Setup (Intel 82579LM/82583V).....	79

Appendix A **Programming the Watchdog Timer..81**

A.1	Programming the Watchdog Timer	82
A.1.1	Watchdog Timer Overview.....	82
A.1.2	Programming the Watchdog Timer	82
	Table A.1: Watchdog Timer Registers	84
A.1.3	Example Program	85

Appendix B **I/O Pin Assignments.....89**

B.1	USB Header (USB56, USB78,USB9010,USB1112)	90
	Table B.1: USB Header (USB56).....	90
B.2	VGA Connector (VGA1)	90
	Table B.2: VGA Connector (VGA1)	90
B.3	DVI1:DVI connector	91
	Table B.3: DVI1:DVI connector.....	91
B.4	SPI_CN1: SPI Fresh Card Pin Connector.....	91
	Table B.4: SPI_CN1:SPI Fresh Card Pin Connector	91
B.5	PS/2 Keyboard and Mouse Connector (KBMS1)	92
	Table B.5: PS/2 Keyboard and Mouse Connector (KBMS1)	92
B.6	RS-232 Interface (COM3/4/5/6)	92
	Table B.6: RS-232 Interface (COM4~COM6)	93
B.7	CPU Fan Power Connector (CPU_FAN1)	93
	Table B.7: CPU Fan Power Connector (CPU_FAN1).....	93
B.8	System Fan Power Connector (SYS_FAN1/2/3/4)	94
	Table B.8: System Fan Power Connector (SYSFAN1/SYSFAN2/ SYSFAN3/SYSFAN4).....	94
B.9	Power LED & Keyboard Lock Connector (JFP2)	94
	Table B.9: Power LED & Keyboard Lock Connector (JFP2).....	94
B.10	Power switch/HDD LED/SMBus/Speaker (JFP1)	95
	Table B.10:Power Switch/HDD LED/SMBus/Speaker (JFP1)	95
B.11	USB/LAN ports (LAN1_USB12/LAN2_USB34).....	95
	Table B.11:USB Port.....	95
	Table B.12:Ethernet 10/100 Mbps RJ-45 Port	95
B.12	Line In, Line Out, Mic In Connector (AUDIO1).....	96
B.13	Serial ATA0/1 (SATA1 ~ 6)	96
	Table B.13:Serial ATA 0/1 (SATA1 ~ 6)	96
B.14	AT/ATX Mode (PSON1)	96
	Table B.14:AT/ATX Mode (PSON1)	96
B.15	HD Audio Interface (FPAUD1)	96
	Table B.15:AC-97 Audio Interface (FPAUD1).....	96
B.16	GPIO Pin Header (GPIO1).....	97

	Table B.16:GPIO Pin Header (GPIO1).....	97
B.17	LVDS Connector: LVDS1.....	97
	Table B.17:LVDS1 Connector	97
B.18	LVDS Power Jumper (JLVDS1).....	98
	Table B.18:LVDS Power Jumper.....	98
B.19	LVDS Inverter (INV1).....	98
	Table B.19:LVDS Power Jumper.....	98
B.20	ATX Power Connector (ATXPWR1)	99
	Table B.20:ATX Power Connector (ATXPWR1).....	99
B.21	ATX 12 V connector (ATX12V1).....	100
	Table B.21:ATX 12 V connector (ATX12V1)	100
B.22	DMA Channel Assignments.....	100
	Table B.22:DMA Channel Assignments	100
B.23	Interrupt Assignments.....	101
	Table B.23:Interrupt Assignments	101
B.24	1st MB Memory Map.....	101
	Table B.24:1st MB Memory Map	101

Chapter 1

General Information

1.1 Introduction

AIMB-581 is designed with the Intel Q67/C206 for industrial application that require both performance computing and enhanced power management capabilities. The motherboard supports Intel Core i7-2600 3.4GHz/Core i5 3.1GHz/Core i3 3.3GHz/ Pentium G850 2.9GHz/Celeron G540 2.5 GHz processor up to 8 MB L3 cache and DDR3 1066/1333 up to 16 GB. A rich I/O connectivity of 6 serial ports, 10 USB 2.0, 2 USB 3.0, dual GbE LAN, 4 SATA II ports and 2 SATA III ports.

1.2 Features

- **Rich I/O connectivity:** Dual GbE LAN via PCIe x 1 bus, 2 x PCI 32-bit/33MHz PCI slots, 10 USB 2.0 ports and 2 USB 2.0 ports.
- **Standard Mini-ITX form factor with industrial feature:** The AIMB-581 is a full featured Micro ATX motherboard with balanced expandability and performance.
- **Wide selection of storage devices:** SATA HDD, customers benefit from the flexibility of using the most suitable storage device for larger capacity
- **Optimized integrated graphic solution:** With Intel® Graphics Flexible, it supports versatile display options and 32-bit 3D graphics engine

1.3 Specifications

1.3.1 System

- **CPU:** Intel Core i7-2600 3.4GHz/Core i5 3.1GHz /Core i3 3.3GHz/ Pentium G850 2.9GHz/Celeron G540 2.5GHz processor
- **BIOS:** AMI EFI 64 Mbit SPI BIOS
- **System chipset:** Intel® Q67/C206
- **SATA hard disk drive interface:** Four on-board SATA connectors with data transmission rate up to 300 MB, and two on-board SATA connectors with data transmission rate up to 600 MB

1.3.2 Memory

- **RAM:** Up to 16 GB in 4 slots 204-pin DIMM sockets. Supports dual-channel DDR3 1066/1333 MHz SDRAM.
 - AIMB-581QG2 supports non-ECC unbuffered DIMMs and do not support any memory configuration that mixes non-ECC with ECC unbuffered DIMMs.
 - AIMB-581WG2 supports ECC buffered DIMMs.

Note! A 32-bit OS may not fully detected 4GB of RAM when 4 GB is installed.



1.3.3 Input/Output

- **PCIe slot:** 1 PCIe x 16 expansion slot, 1 PCIe x 4 expansion slot, and 1 PCIe x 1 expansion slot.
- **PCIe Bus:** 2 PCI slots, 32-bit/33 MHz PCI 2.2 compliant
- **Enhanced parallel port:** Configured to LPT1 or disabled. Standard DB-25 female connector cable is an optional accessory. LPT1 supports EPP/SPP/ECP.
- **Serial port:** Six serial ports, one is RS-232/422/485 with hardware auto-flow control and three are RS-232. Two DB-9 connectors located in rear panel are RS-232.
- **Keyboard and PS/2 mouse connector:** Two 6-pin mini-DIN connectors are located on the mounting bracket for easy connection to PS/2 keyboard and mouse.
- **USB port:** Supports up to 10 USB 2.0 ports with transmission rates up to 480 Mbps and 2 USB 3.0 ports with transmission rates up to 5 Gbps.
- **GPIO:** AIMB-581 supports 8-bit GPIO from super I/O for general purpose control application.

1.3.4 Graphics

- **Controller:** Intel® HD Graphics
- **Display memory:** 1 GB maximum shared memory with 2GB and above system memory installed
- **DVI:** Supports DVI up to resolution 1920 x 1200 @ 60Hz refresh rate
- **VGA:** Supports VGA up to resolution 2048 x 1536 @ 75Hz refresh rate
- **LVDS:** Supports LVDS up to resolution 1920 x 1200

1.3.5 Ethernet LAN

- Supports dual 10/100/1000 Mbps Ethernet port (s) via PCI Express x1 bus which provides 500 MB/s data transmission rate
- **Controller:** LAN1: Intel 82579LM; LAN2: Intel 82583V

1.3.6 Industrial features

- **Watchdog timer:** Can generate a system reset. The watchdog timer is programmable, with each unit equal to one second or one minute (255 levels)

1.3.7 Mechanical and environmental specifications

- **Operating temperature:** 0 ~ 60° C (32 ~ 140° F, Depending on CPU)
- **Storage temperature:** -40 ~ 85° C (-40 ~ 185° F)
- **Humidity:** 5 ~ 95% non-condensing
- **Power supply voltage:** +3.3 V, +5 V, +12 V, -12 V, 5 Vsb
- **Power consumption:**
 - Intel LGA1155 Core i7-2600 3.4 GHz, 8MB L3 cache, 4 pcs 2GB DDR3 133 MHz, +5V @ 2.88A, +3.3V @ 1.06A, +12V @ 3.3A, 5Vsb @ 0.36A, -12V @ 0.01A
 - Measure the maximum current value which system under maximum load (CPU: Top speed, RAM & Graphic: Full loading)
- **Board size:** 240 mm x 240 mm(9.6" x 9.6")
- **Board weight:** 0.365 kg

1.4 Jumpers and Connectors

Connectors on the AIMB-581 motherboard link it to devices such as hard disk drives and a keyboard. In addition, the board has a number of jumpers used to configure your system for your application.

The tables below list the function of each of the board jumpers and connectors. Later sections in this chapter give instructions on setting jumpers. Chapter 2 gives instructions for connecting external devices to your motherboard.

Table 1.1: Jumpers

Label	Function
JFP1	Power switch/HDD LED/SMBus/Speaker
JFP2	Power LED and Keyboard lock
CMOS1	CMOS clear (Default 1-2)
PSON1	AT(1-2) / ATX(2-3) (Default 2-3)
JWDT1+JOBS1	Watchdog Reset and OBS Alarm
JCASE1	Case Open pin header
JLVDS1	Voltage 3.3V/5V/12V selector for LVDS1 connector (Default 1-2, 3.3V)
JLVDS_CLT1	Brightness control selector for Analog or Digital (Default 1-2, Analog)
JEME1	Intel AMT Disable Jumper
JMECLR1	Clear AMT setting
JUSBPWR1	USB port 1~4 power source switch between +5Vsb and +5V
JUSBPWR2	USB port 5/6/7/8 power source switch between +5Vsb and +5V
JUSB PWR3	USB port 9/10/11/12 power source switch between +5Vsb and +5V

Table 1.2: Connectors

Label	Function
LPT1	Parallel port, supports SPP/EPP/ECP mode
LVDS1	LVDS1 connector
INV1	LVDS1 inverter connector
COM3456	Serials port connector (RS-232)
USB56	USB port 5, 6 (on board)
USB78	USB port 7, 8 (on board)
USB910	USB port 9, 10 (on board)
USB1112	USB port 11, 12 (on board)
VGA1+DVI1	VGA and DVI connector
COM12	Serial port connector(RS232)
KBMS1	PS/2 Keyboard and Mouse connector
CPUFAN1	CPU FAN connector(3-pin)
SYSFAN1	System FAN1 connector(4-pin)
SYSFAN2	System FAN2 connector(4-pin)
SYSFAN3	System FAN3 connector(4-pin)
SYSFAN4	System FAN4 connector(4-pin)
LAN1_USB12	LAN1 / USB port 1, 2
LAN2_USB34	LAN2 / USB port 3, 4

Table 1.2: Connectors

AUDIO1	Audio connector
SPDIF_OUT1	SPDIF Audio out pin header
FPAUD1	HD Audio Front Panel Pin Header
PCIEX16_1	PCIe x16 Slot
SATA1	Serial ATA data connector 1
SATA2	Serial ATA data connector 2
SATA3	Serial ATA data connector 3
SATA4	Serial ATA data connector 4
SATA5	Serial ATA data connector 5
SATA6	Serial ATA data connector 6
DIMMA1	Channel A DIMM1
SPI_CN1	SPI flash update connector.
GPIO1	GPIO header
ATX12V1	ATX 12V Auxiliary power connector (for CPU)
ATXPWR1	ATX 20 Pin Main power connector (for System)
DVI	DVI-D connector on rear panel
DVI2	DVI-D pin header

1.5 Board layout: Jumper and Connector Locations

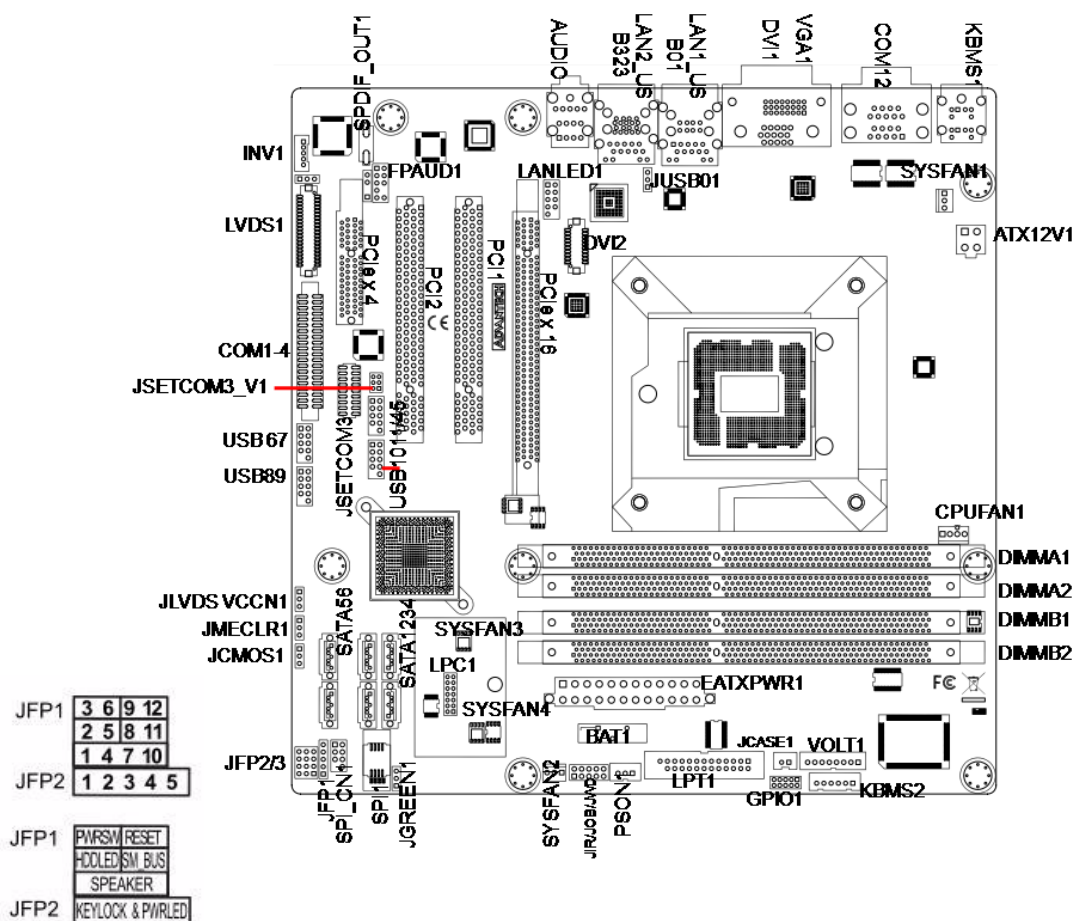

Figure 1.1 Jumper and Connector Location



Figure 1.2 I/O Connectors

1.6 AIMB-581 Board Diagram

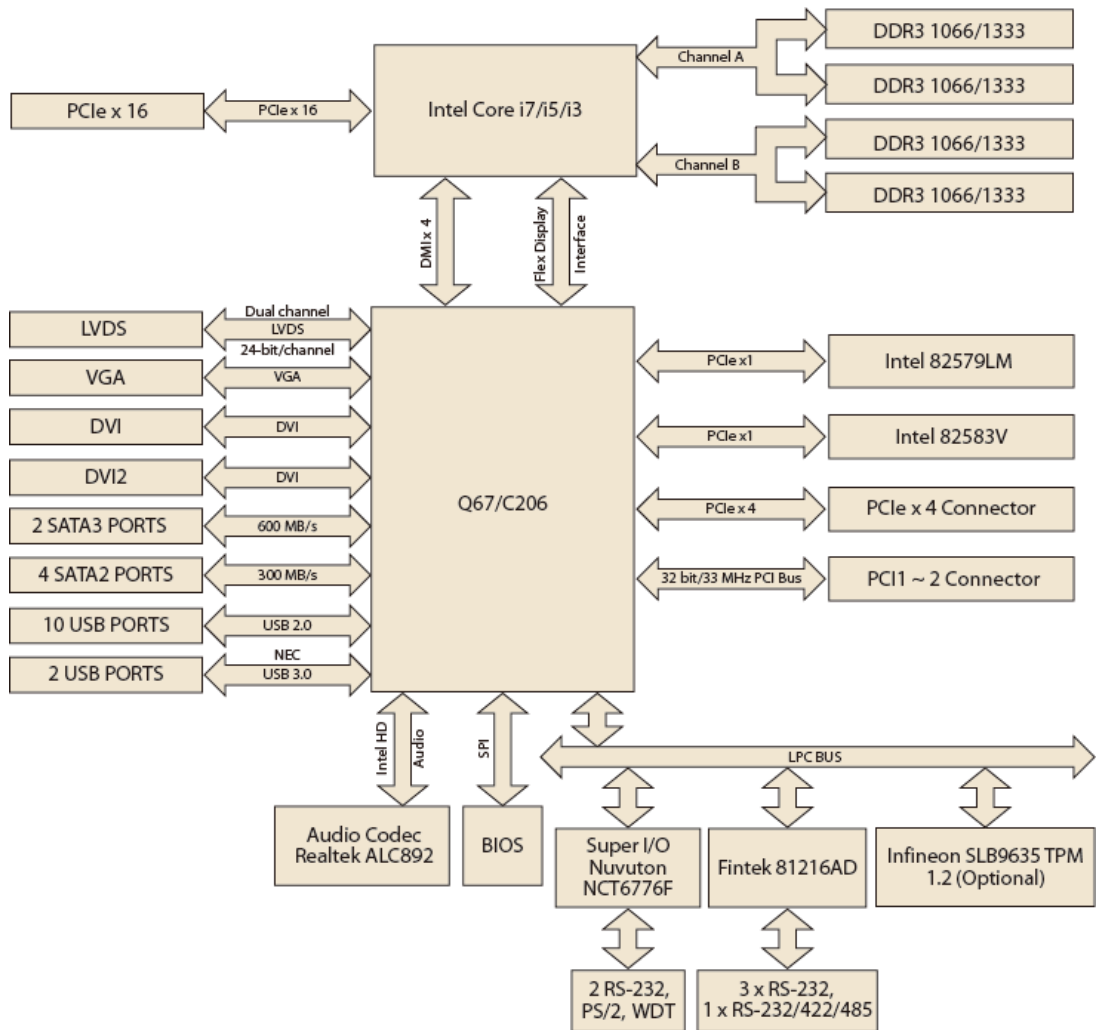

Figure 1.3 AIMB-581 Board Diagram

1.7 Safety Precautions

Warning! Always completely disconnect the power cord from chassis whenever you work with the hardware. Do not make connections while the power is on. Sensitive electronic components can be damaged by sudden power surges. Only experienced electronics personnel should open the PC chassis.



Caution! Always ground yourself to remove any static charge before touching the motherboard. Modern electronic devices are very sensitive to electrostatic discharges. As a safety precaution, use a grounding wrist strap at all times. Place all electronic components on a static-dissipative surface or in a static-shielded bag when they are not in the chassis.



Caution! The computer is provided with a battery-powered real-time clock circuit. There is a danger of explosion if battery is incorrectly replaced. Replace only with same or equivalent type recommended by the manufacturer. Discard used batteries according to manufacturer's instructions.



Caution! There is a danger of a new battery exploding if it is incorrectly installed. Do not attempt to recharge, force open, or heat the battery. Replace the battery only with the same or equivalent type recommended by the manufacturer. Discard used batteries according to the manufacturer's instructions.



1.8 Jumper Settings

This section provides instructions on how to configure your motherboard by setting the jumpers. It also includes the motherboards's default settings and your options for each jumper.



1.8.1 How to Set Jumpers

You can configure your motherboard to match the needs of your application by setting the jumpers. A jumper is a metal bridge that closes an electrical circuit. It consists of two metal pins and a small metal clip (often protected by a plastic cover) that slides over the pins to connect them. To “close” (or turn ON) a jumper, you connect the pins with the clip. To “open” (or turn OFF) a jumper, you remove the clip. Sometimes a jumper consists of a set of three pins, labeled 1, 2, and 3. In this case you connect either pins 1 and 2, or 2 and 3. A pair of needle-nose pliers may be useful when setting jumpers.

1.8.2 CMOS Clear (CMOS1)

The AIMB-581 motherboard contains a jumper that can erase CMOS data and reset the system BIOS information. Normally this jumper should be set with pins 1-2 closed. If you want to reset the CMOS data, set CMOS1 to 2-3 closed for just a few seconds, and then move the jumper back to 1-2 closed. This procedure will reset the CMOS to its default setting.

Table 1.3: CMOS1

Function	Jumper Setting
*Keep CMOS data	 1-2 closed
Clear CMOS data	 2-3 closed

* Default

1.8.3 JLVDS1: LCD Power 3.3 V/5 V/ 12 V Selector

Table 1.4: JLVDS1: LCD Power 3.3 V/5 V/ 12 V Selector

Closed Pins	Result
JLVDS1	
2-4	Jumper for 5V LVDS panel
4-6	Jumper for 3.3V LVDS panel*
3-4	Jumper for 12V LVDS panel

*Default

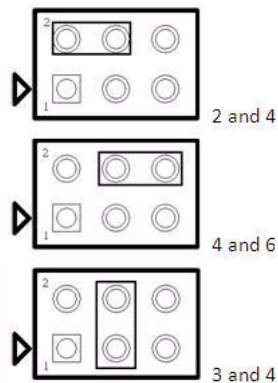

1.8.4 JLVD5_CLT1: Backlight control selector for LVDS1

Table 1.5: JLVD5_CLT1: Backlight control selector for LVDS1

Closed Pins	Result
1-2*	Linear brightness control
2-3	PWM brightness control

*Default

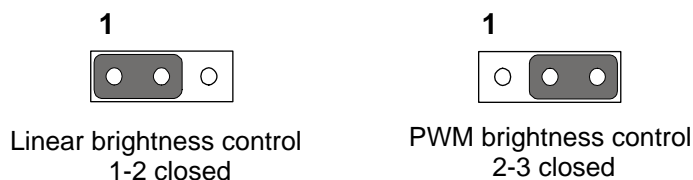

1.8.5 PSON1: ATX, AT Mode Selector

Table 1.6: PSON1: ATX, AT Mode Selector

Closed Pins	Result
1-2	AT Mode
2-3*	ATX Mode

*Default



1.8.6 JWDT1+JOBS1: Watchdog Timer Output and OBS Alarm Option

Table 1.7: JWDT1+JOBS1: Watchdog Timer Output and OBS Alarm Option

Closed Pins	Result
1-2	NC
2-3*	System Reset*
4-5*	Error Beep*

*Default

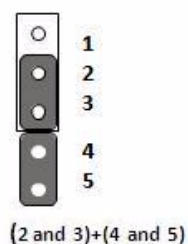

1.8.7 JME1:BIOS Update ME Mode Selector

JWE1 is the jumper for user to select update BIOS freely without lock protection when using ADVSPI or with lock protection.

Table 1.8: BIOS update ME mode selector

Function	Jumper Setting	BIOS protect	Master Region Access Control	Update tool	ME version	ME function after updated	Setting	JWE1 PWR working status
1.*Production mode	(1-2) pin closed	None	FF	ADVSPI	updated	Link/remote control	default	AC on/standby
2.		Lock Read:0B Write:0A	ADVSPI	no updated	Link/remote control	OEM request	AC on/standby	
3. Manufacture mode	(2-3) pin closed	None	FF	ADVSPI	updated	None	None	None

* refers to default.

- * In default production mode, there's no lock protection for BIOS. The Master Region Access Control setting is FF, users can update complete BIOS with ADVSPI tool. The function is same as Manufacture mode. BIOS ME(Management Engine) function keeps link and remote control. The jumper can be set under AC off PWR status, can not set under standby PWR status.
- In production mode with lock protection for BIOS, the Master Region Access Control setting is Read:0B, Write:0A. Users can not update BIOS ME firmware freely. BIOS ME(Management Engine) function keeps link and remote control. This setting is only for OEM project request. The jumper can be set under AC off PWR status, can not set under standby PWR status.
- In manufacture mode, BIOS has no lock protection function. The Master Region Access Control setting is FF, users can update complete BIOS with ADVSPI tool. However, the BIOS ME function no keep link and remote control after bios been updated.

1.8.8 JCASE1: Case Open Sensor

The AIMB-581 motherboard contains a jumper that provides a chassis open sensor. The buzzer on the motherboard beeps when the case is opened.

1.9 System Memory

AIMB-581 has four 240-pin memory sockets for 1066/1333 MHz memory modules with maximum capacity of 16GB(Maximum 4GB for each DIMM). AIMB-581QG2 supports only non-ECC DDR3 memory modules and do not support registered DIMMs (RDIMMs)

Note!



Because AIMB-581 supports Intel Active Management Technology 7.0 (iAMT 7.0) which utilizes some memory space of channel 0, it's suggested that the user should not leave channel 0 DIMM slots (DIMMA1 and DIMMA2) empty, or it may cause some system abnormality.

1.10 Memory Installation Procedures

To install DIMMs, first make sure the two handles of the DIMM socket are in the “open” position, i.e., the handles lean outward. Slowly slide the DIMM module along the plastic guides on both ends of the socket. Then firmly but gently (avoid pushing down too hard) press the DIMM module well down into the socket, until you hear a click when the two handles have automatically locked the memory module into the correct position of the DIMM socket. To remove the memory module, just push both handles outward, and the memory module will be ejected by the mechanism.

1.11 Cache Memory

The AIMB-581 supports a CPU with one of the following built-in full speed L3 caches:

8 MB for Intel Xeon E3-1275

6 MB for Intel Xeon E3-1225

8 MB for Intel Core i7-2600

6 MB for Intel Core i5-2400

3 MB for Intel Core i3-2120

3 MB for Intel Pentium G850

2 MB for Intel Celeron G540

The built-in second-level cache in the processor yields much higher performance than conventional external cache memories.

1.12 Processor Installation

The AIMB-581 is designed for LGA1155, Intel Xeon and Intel Core i7/Core i5/Core i3/Pentium/Celeron processor.

1.13 PCI Bus Routing Table

AD PCI slot INT	PCI1	PCI2
	AD16	AD21
A	A	F
B	B	G
C	C	H
D	D	E

Chapter 2

Connecting
Peripherals

2.1 Introduction

You can access most of the connectors from the top of the board as it is being installed in the chassis. If you have a number of cards installed or have a packed chassis, you may need to partially remove the card to make all the connections.

2.2 USB Ports (LAN1_USB12/LAN2_USB34/USB56/USB78)

The AIMB-581 provides up to 12 USB ports. The USB interface complies with USB Specification Rev 2.0 supporting transmission rate up to 480 Mbps and Rev 3.0 supporting transmission rate up to 5 Gbps and is fuse protected. The USB interface can be disabled in the system BIOS setup.

The AIMB-581 is equipped with two high-performance 1000 Mbps Ethernet LAN adapters, both of which are supported by all major network operating systems. The RJ-45 jacks on the rear panel provides for convenient LAN connection.

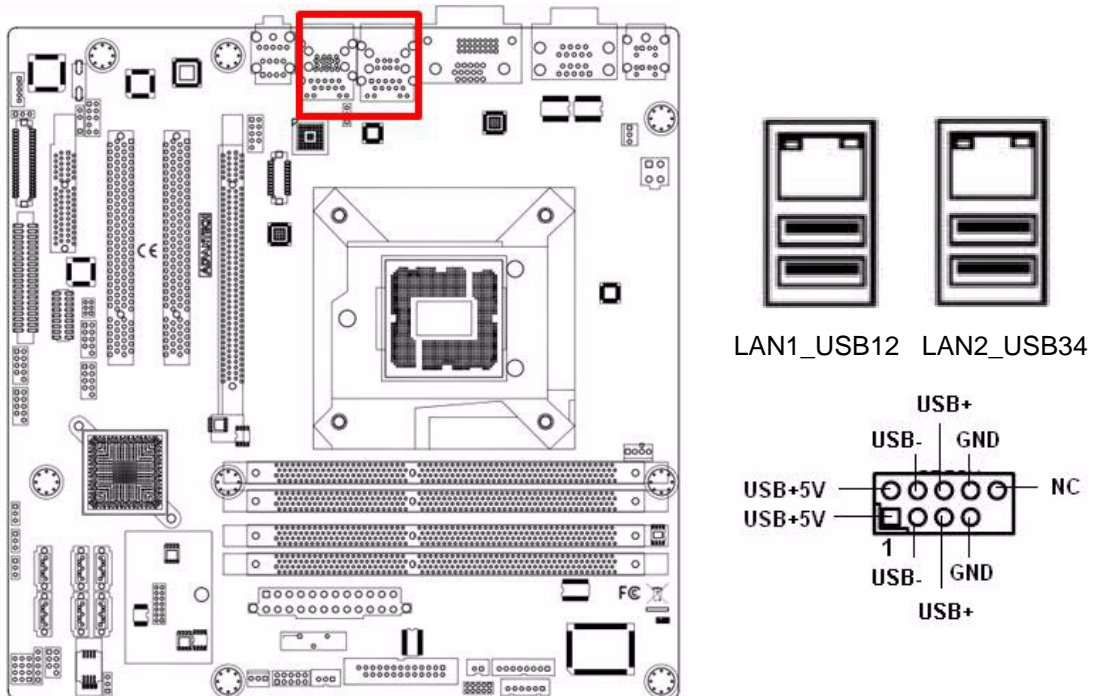
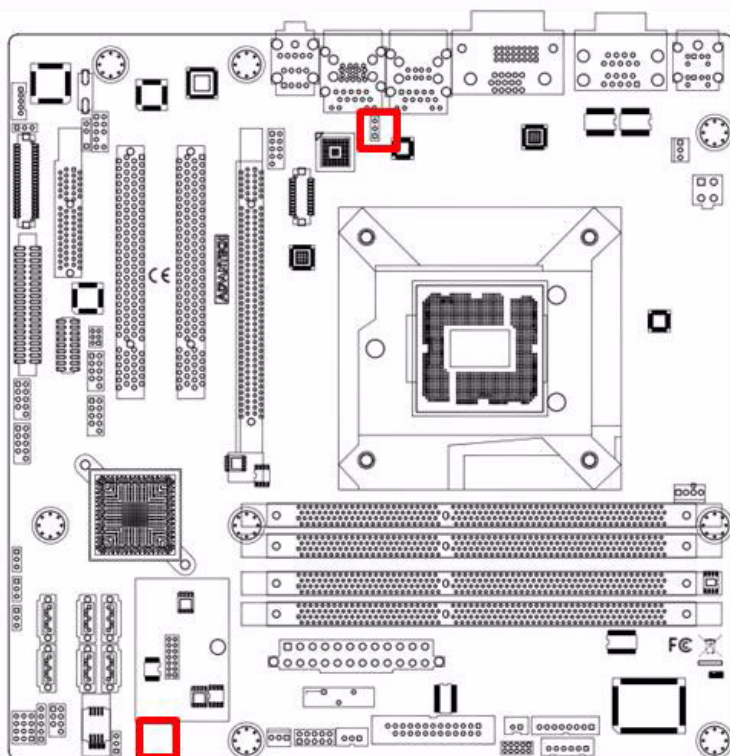

Table 2.1: LAN LED Indicator

LAN Mode	LAN Indicator	
LAN1 indicator	LED1 (Right)	off for mal-link; Link (On) / Active (Flash)
	LED2 (Left)	100 Mbps (On) / 10 Mbps (Off)
	LED2 (Left)	1000 Mbps (On)
LAN2 indicator	LED1 (Right)	off for mal-link; Link (On) / Active (Flash)
	LED2 (Left)	100 Mbps (On) / 10 Mbps (Off)
	LED2 (Left)	1000 Mbps (On)

2.3 USB Power Switch

AIMB-581 allows users to set USB power between +5VSB and +5V. When the jumper is set as +5V, the board doesn't support waked from S3 via keyboard or mouse.



Jumper	USB Ports
JUSBPWR1	USB port 1-4
JUSBPWR2	USB port 5/6/7/8/11/12

Note! When USB power is switched to +5V, it can't be connected with power KVM.



2.4 VGA/DVI-D Connector(VGA1+DVI1), DVI2 Connector

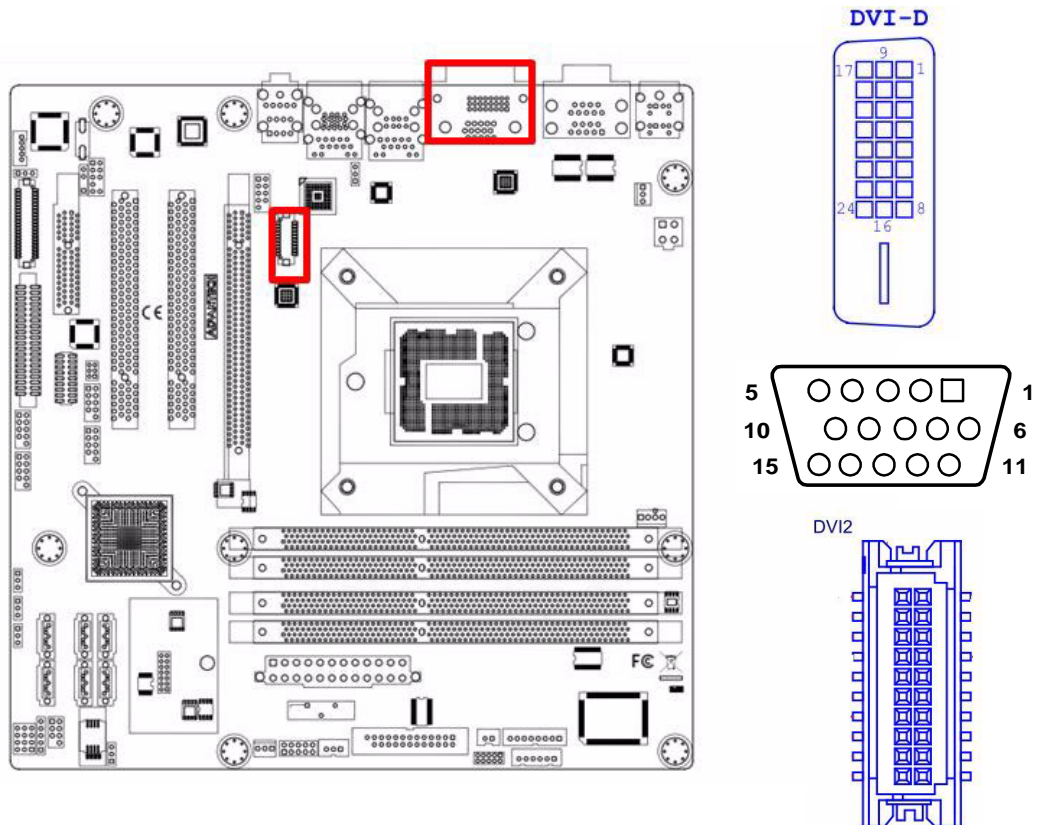

AIMB-581 includes VGA and DVI interface that can drive conventional VGA and DVI displays. VGA is a standard 15-pin D-SUB connector commonly used for VGA. Pin assignment for VGA and DVI connector are detailed in Appendix B.

AIMB-581 also includes DVI2 as the interface for support 2nd DVI display.

2.5 Serial Ports (COM1~COM6)

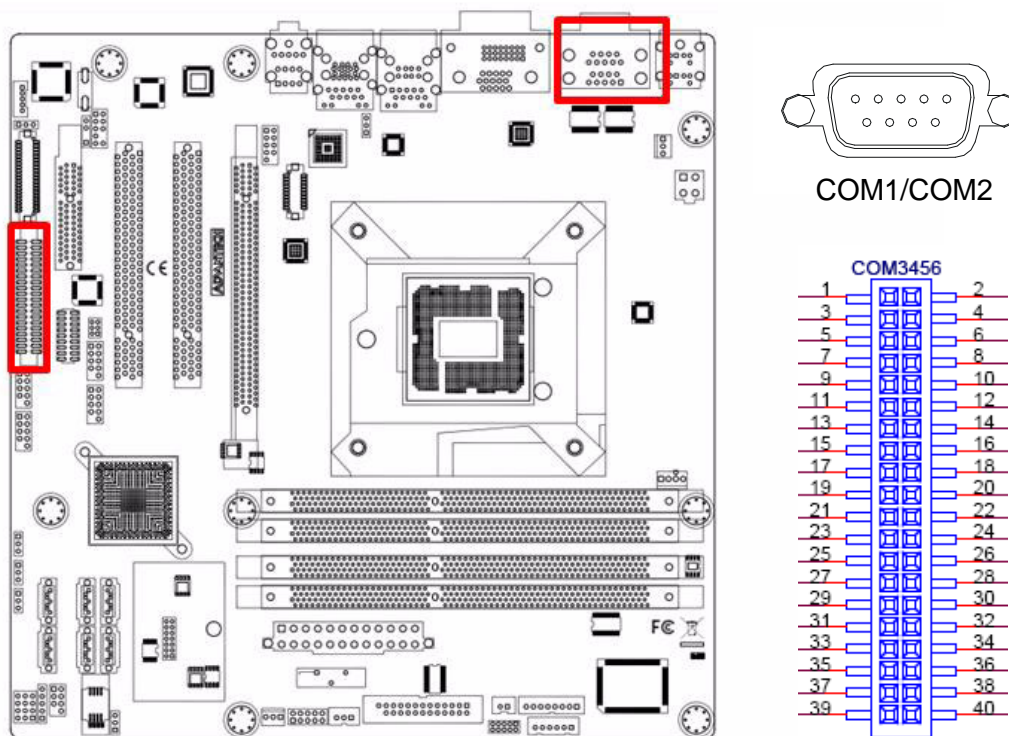

AIMB-581 supports six serial ports. COM1, COM2, COM4-6 supports RS-232. COM3 supports RS-232/422/485(with 5V/12V power). JSETCOM3 is used to select the RS-232/422/485 mode for COM3.

These ports can connect to serial devices, such as a mouse or a printer, or to a communications network.

The IRQ and address ranges for both ports are fixed. However, if you want to disable the port or change these parameters later, you can do this in the system BIOS setup.

Different devices implement the RS-232 standards in different ways. If you have problems with a serial device, be sure to check the pin assignments for the connector.

2.6 PS/2 Keyboard and Mouse Connector (KBMS1)/ External PS/2 Keyboard and Mouse Connector(KBMS2)

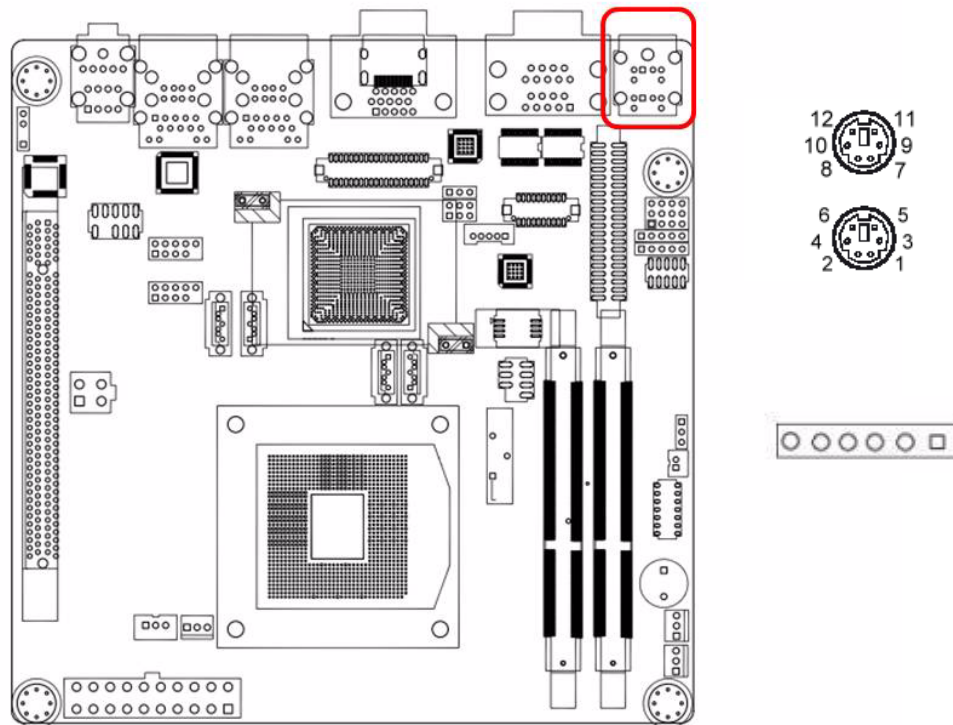

Two 6-pin mini-DIN connectors (KBMS1) on the motherboard provide connection to a PS/2 keyboard and a PS/2 mouse, respectively. KBMS2 is to support the 2nd PS/2 keyboard and PS/2 mouse by a cable P/N 1700018699.

2.7 CPU Fan Connector (CPU_FAN1)

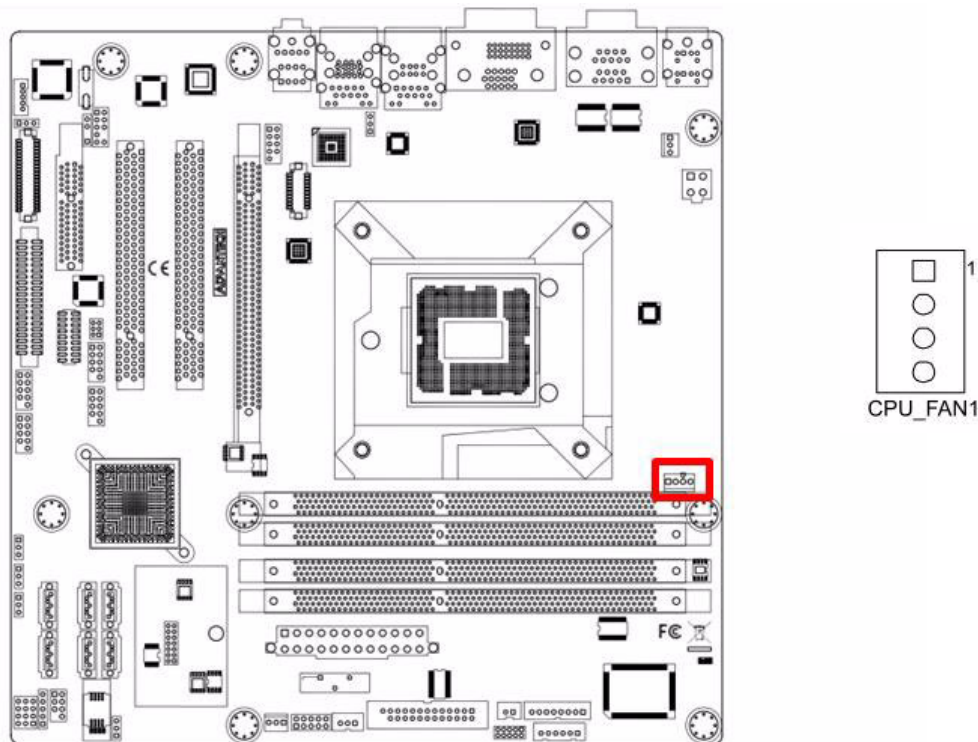

If a fan is used, this connector supports cooling fans of 500 mA (6 W) or less.

2.8 System FAN Connector (SYSFAN1/2/3/4)

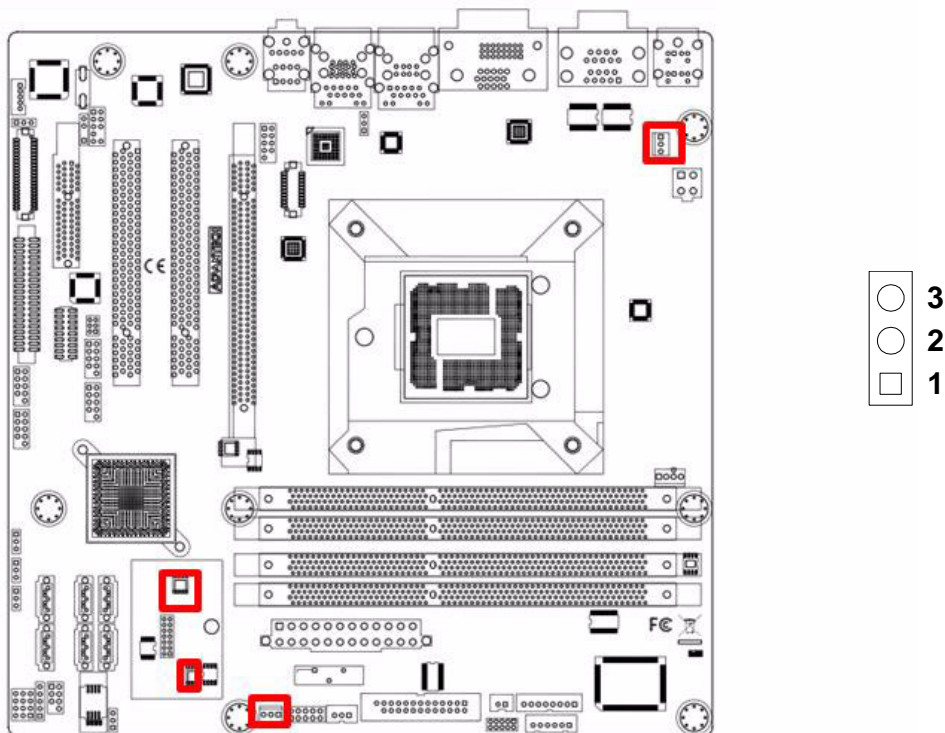

If a fan is used, this connector supports cooling fans of 500 mA (6 W) or less.

2.9 Front Panel Connectors (JFP1/JFP2/JFP3)

There are several headers for monitoring and controlling the AIMB-581.

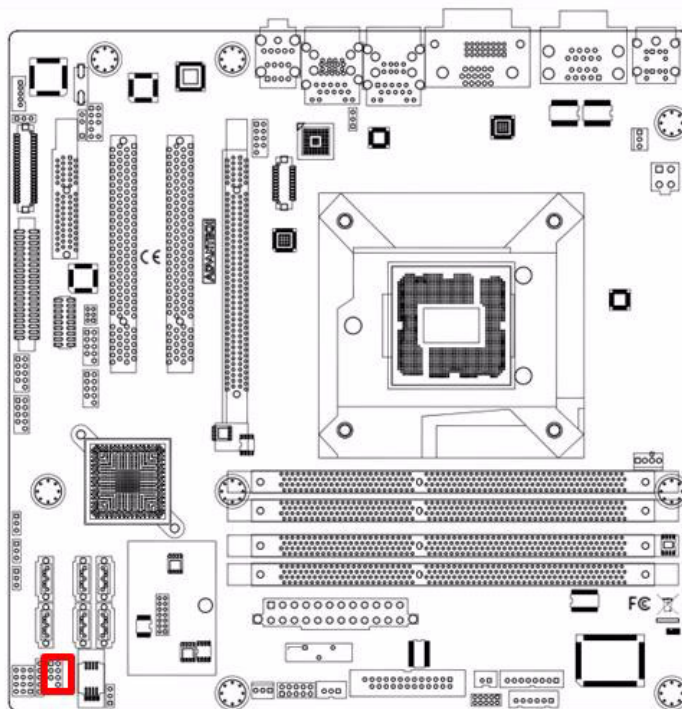

JFP1	3	6	9	12	
JFP1	2	5	8	11	
JFP2	1	4	7	10	
JFP2	1	2	3	4	5

JFP1	3	6	9	12	
JFP1	2	5	8	11	
JFP2	1	4	7	10	
JFP2	1	2	3	4	5

JFP1	PWRSM/RESET
JFP1	HDDLED/SM BUS
JFP1	SPEAKER
JFP2	KEYLOCK & PWRLD

2.9.1 ATX soft power switch ((JFP1/PWR_SW))

If your computer case is equipped with an ATX power supply, you should connect the power on/off button on your computer case to ((JFP1/ PWR_SW)), for convenient power on and off.

2.9.2 Reset (JFP1/RESET)

Many computer cases offer the convenience of a reset button. Connect the wire for the reset button.

2.9.3 HDD LED (JFP1/HDDLED)

You can connect an LED to connector (JFP2/HDDLED) to indicate when the HDD is active.

2.9.4 External speaker (JFP1/SPEAKER)

JFP1/SPEAKER is a 4-pin connector for an external speaker. If there is no external speaker, the AIMB-581 provides an onboard buzzer as an alternative. To enable the buzzer, set pins 7 & 10 as closed.

2.9.5 Power LED and keyboard lock connector (JFP3/PWR_LED & KEY LOCK)

(JFP3/PWR_LED & KEY LOCK) is a 5-pin connector for the power on LED and Key Lock function. Refer to Appendix B for detailed information on the pin assignments. The Power LED cable should be connected to pin 1-3. The key lock button cable should be connected to pin 4-5. There are 3 modes for the power supply connection. The first is “ATX power mode”; the system turns on/off by a momentary power button. The second is “AT Power Mode”; the system turns on/off via the power supply switch. The third is another “AT Power Mode” which makes use of the front panel power switch. The power LED status is indicated in the following table:

Table 2.2: ATX power supply LED status (No support for AT power)

Power mode	LED (ATX Power Mode) (On/off by momentary button)	LED (AT power Mode) (On/off by switching power supply)	LED (AT power Mode) (On/off by front panel switch)
PSON1 (on back plane) jumper setting	pins 2-3 closed	pins 1-2 closed	Connect pins 1 & 2 to panel switch via cable
System On	On	On	On
System Suspend	Fast flashes	Fast flashes	Fast flashes
System Off	Slow flashes	Off	Off

2.10 Line In, Line Out, Mic In Connector (AUDIO1)

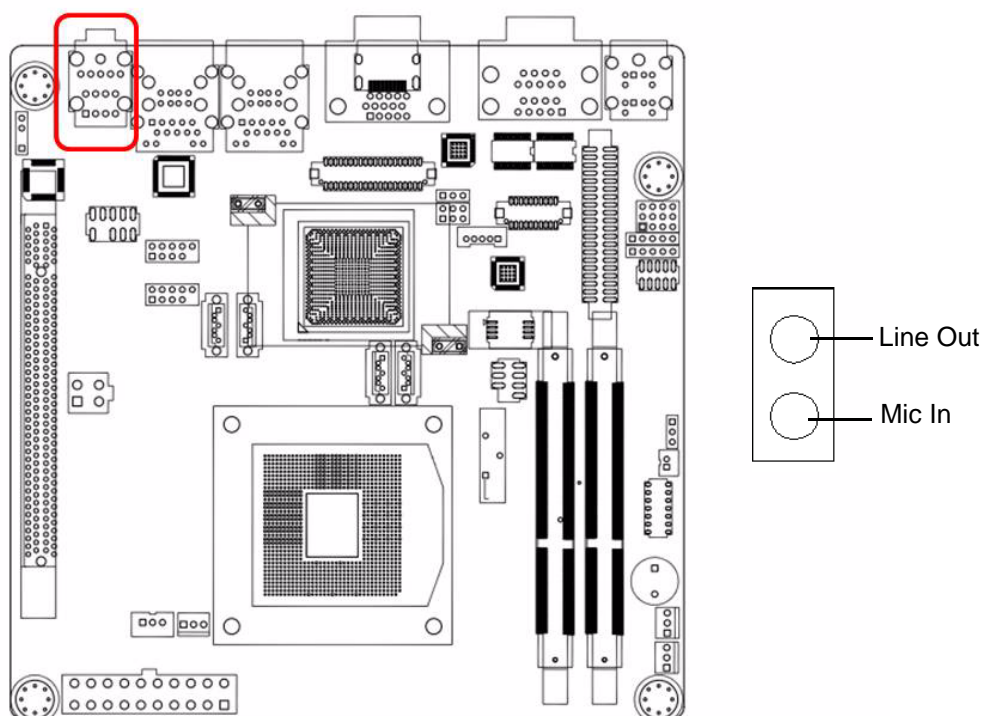

2.11 Digital Audio Connector (SPDIF_OUT1)

This connector is for the S/PDIF audio module to allow digital output sound. Connect one end of the S/PDIF audio cable to this connector and the other end to the S/PDIF module.

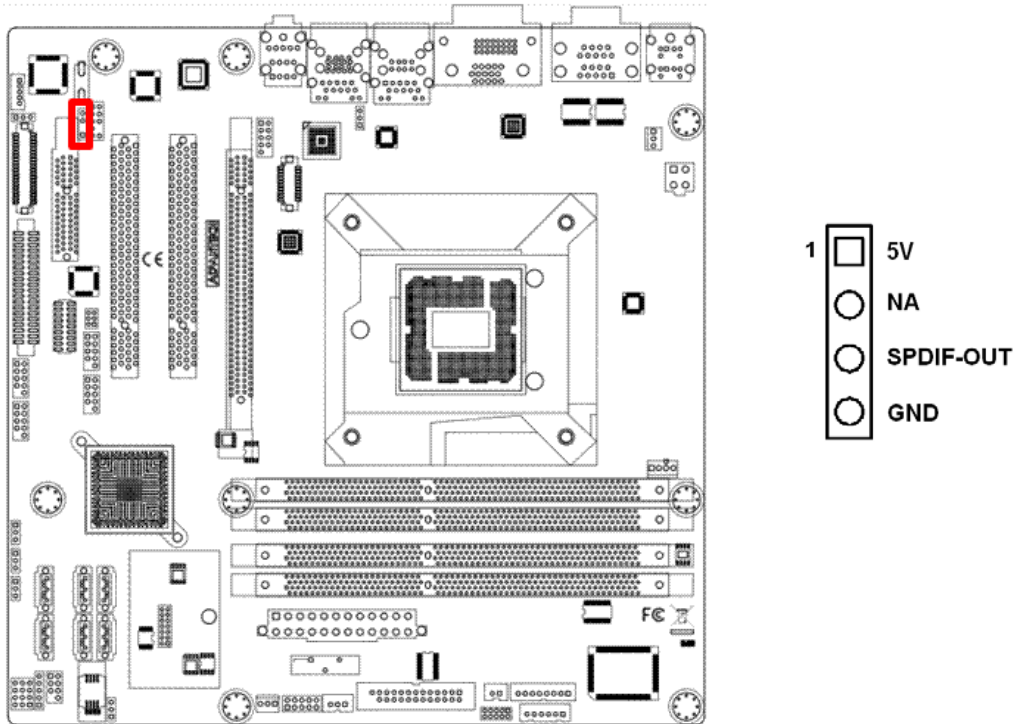

Note! The S/PDIF module is purchased separately.



2.12 Serial ATA Interface (SATA1 ~ SATA6)

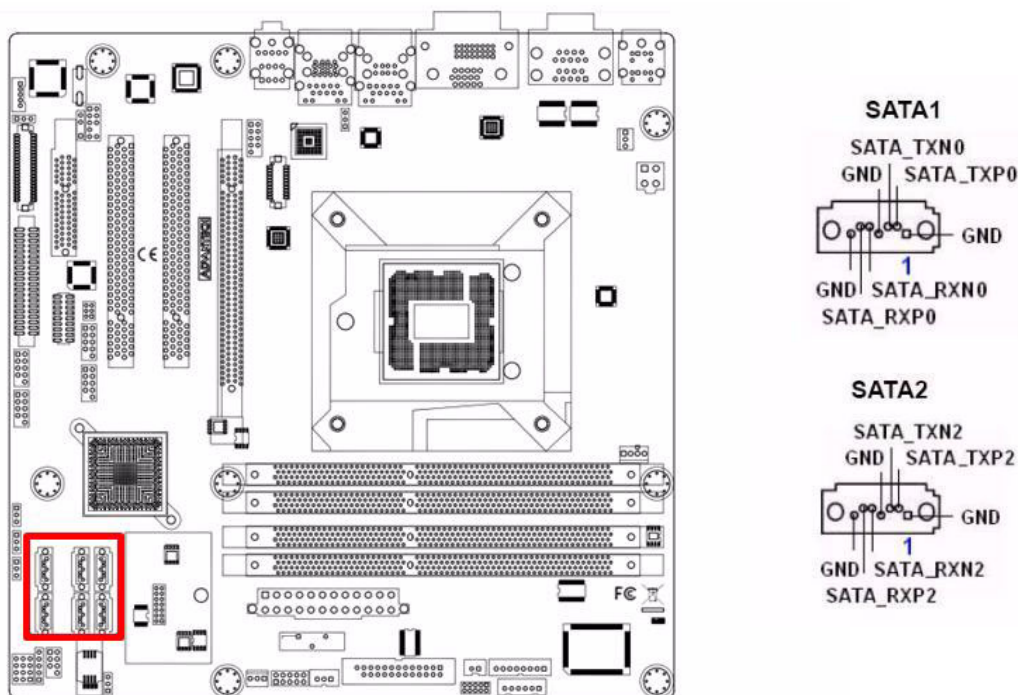

AIMB-581 features a high performance Serial ATA interface (up to 300 MB/s) and Serial ATA III interface (up to 600 MB/s) which eases hard drive cabling with thin, space-saving cables.

Note! *AIMB-581 on board SATA only supports Fedora 14 and 15 and SATA mode in BIOS should be set as AHCI mode.*



If SATA mode is set as IDE mode, when user is installing Fedora 14 and 15, ODD has been connected on SATA port 3~6.

2.13 8-pin Alarm Board Connector(VOLT1)

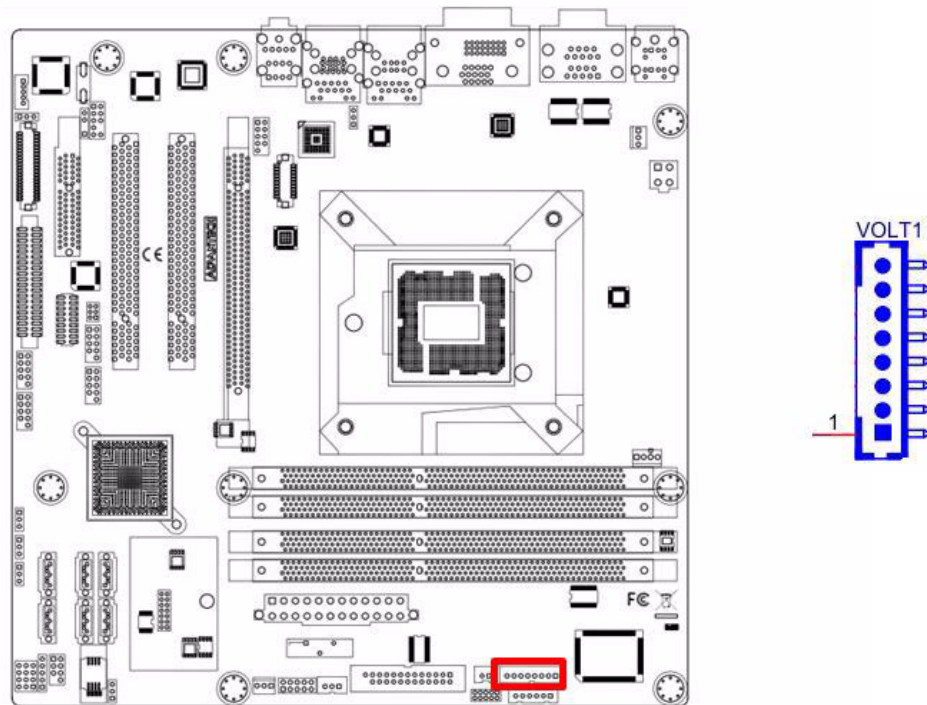

VOLT1 connects to the alarm board of Advantech chassis. These alarm boards give warnings if a power supply or fan fails, if the chassis overheats.

2.14 PCI express x16 slot

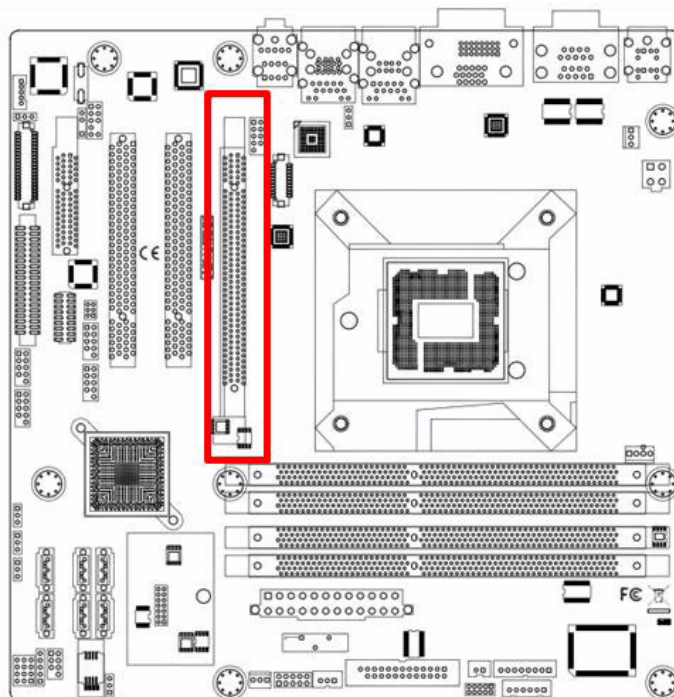

AIMB-581 provides a PCIe x 16 slot for users to install add-on cards when their applications require higher graphic performance than the CPU embedded graphics controller can provide.

2.15 Front Headphone Connector (FPAUD1)

This connector is for a chassis-mounted front panel audio I/O module that supports either HD Audio or legacy AC'97 (optional) audio standard. Connect this connector with the front panel audio I/O module cable.

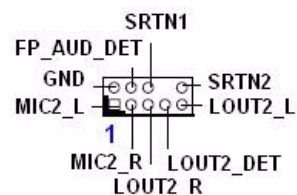
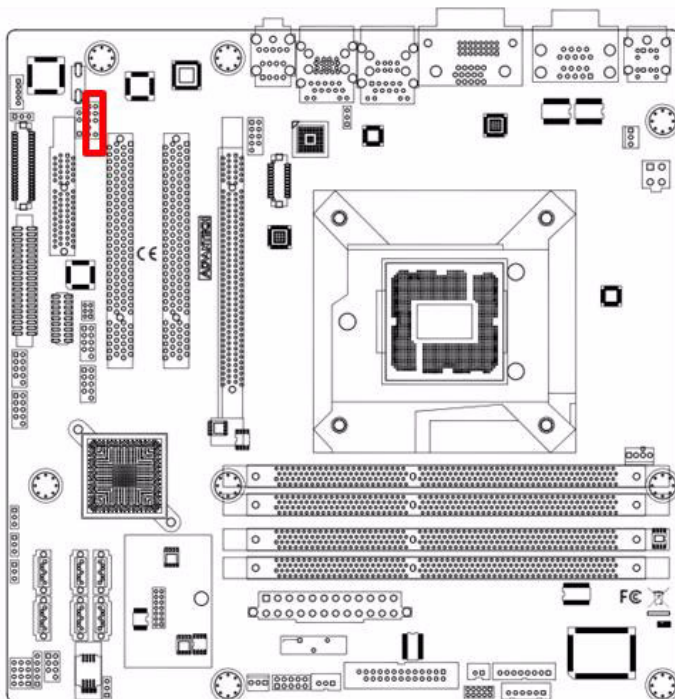

Note! *For motherboards with the optional HD Audio feature, we recommend that you connect a high-definition front panel audio module to this connector to take advantage of the motherboard's high definition audio capability.*



2.16 ATX Power Connector (EATXPWR1, ATX12V1)

This connector is for an ATX Micro-Fit power supply. The plugs from the power supply are designed to fit these connectors in only one direction. Determine the proper orientation and push down firmly until the connectors mate completely.

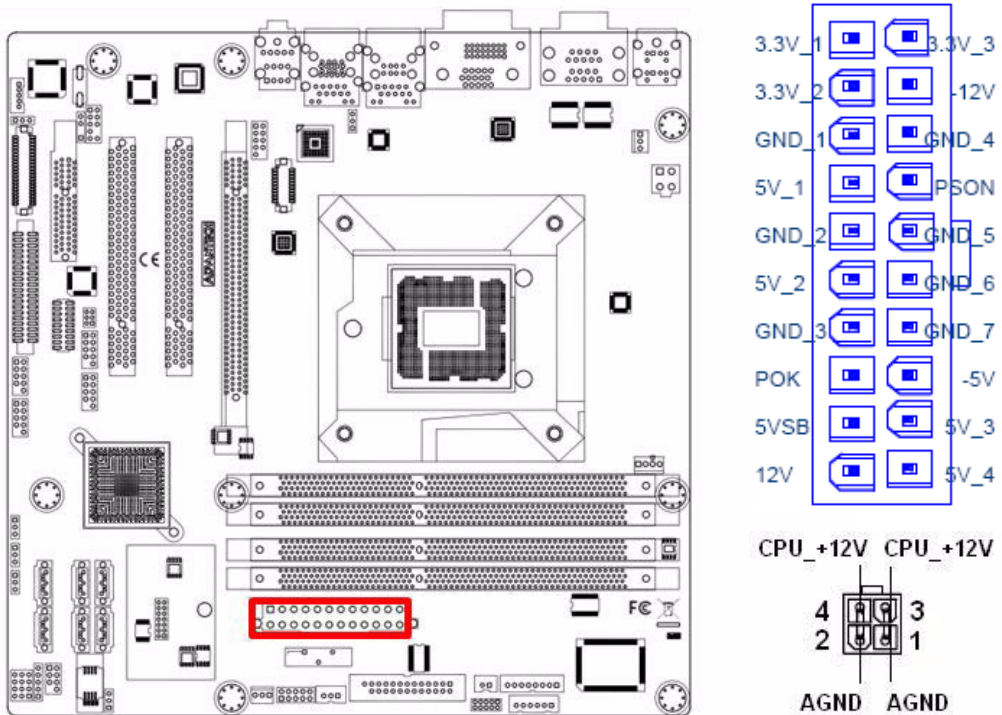

Note!



1. Please do not connect the ATX12V1 connector with the PSU ATX 12V 4-pin connector.
2. For a fully configured system, we recommend that you use a power supply unit (PSU) that complies with ATX 12 V Specification 2.0 (or later version) and provides a minimum power of 180 W.

2.17 SPI Flash connector(SPI_CN1)

The SPI flash card pin header may be used to flash BIOS if the AIMB-581 cannot power on.

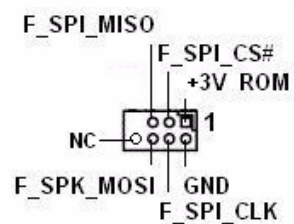
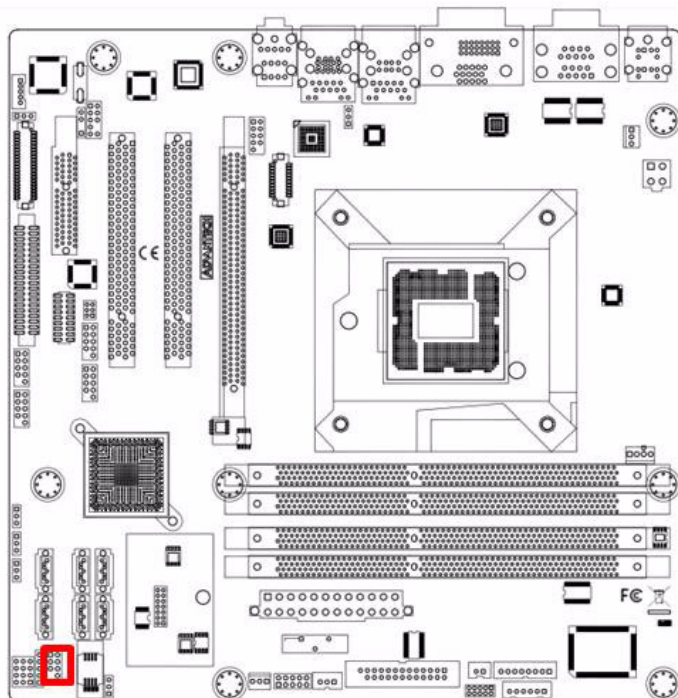

2.18 LCD Inverter Connector (INV1)

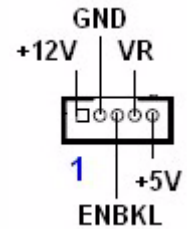
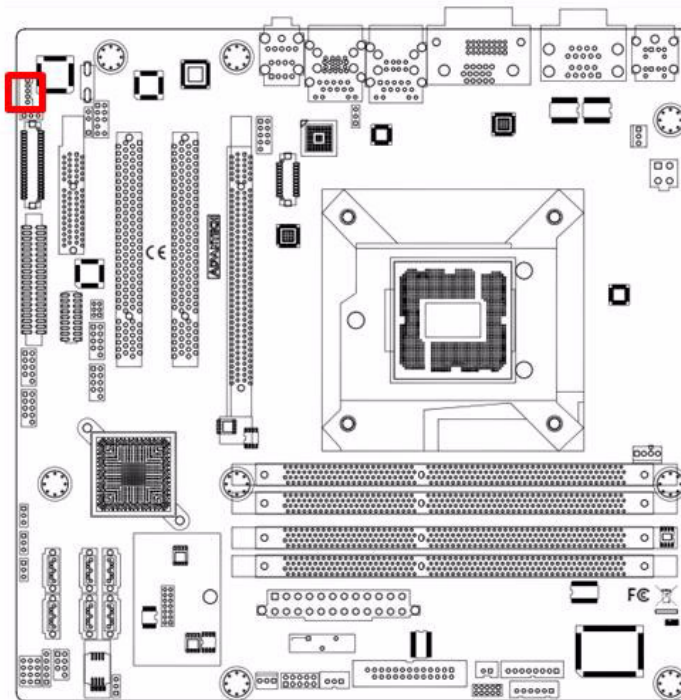

Note!



■ **Signal Description**

Signal

VR

ENBKL

Signal Description

$V_{adj}=0.75\text{ V}$

(Recommended: $4.7\text{ K}\Omega$, $>1/16\text{ W}$)

LCD backlight ON/OFF control signal

2.19 LVDS Connector (LVDS1)

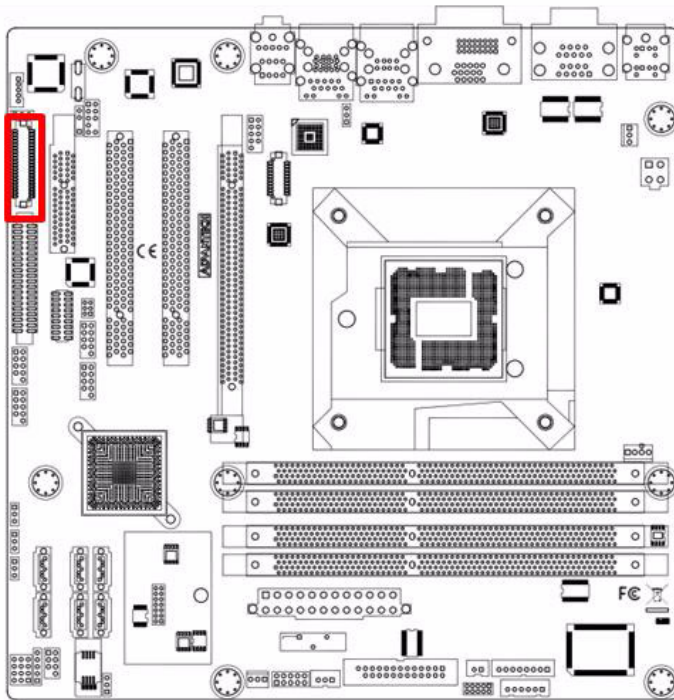

VDDSAFE_1	□	VDDSAFE_2	□
GND_1	○	GND_7	○
VDDSAFE_3	○	VDDSAFE_4	○
OD0-	○	ED0-	○
OD0+	○	ED0+	○
GND_2	○	GND_8	○
OD1-	○	ED1-	○
OD1+	○	ED1+	○
GND_3	○	GND_9	○
OD2-	○	ED2-	○
OD2+	○	ED2+	○
GND_4	○	GND_10	○
OCK-	○	ECK-	○
OCK+	○	ECK+	○
GND_5	○	GND_11	○
DDC_CLK	○	DDC_DAT	○
GND_6	○	GND_12	○
OD3-	○	ED3-	○
OD3+	○	ED3+	○
HPLG	○	VCON	○

2.20 General purpose I/O Connector (GPIO1)

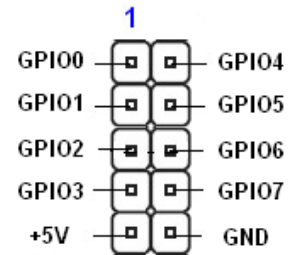
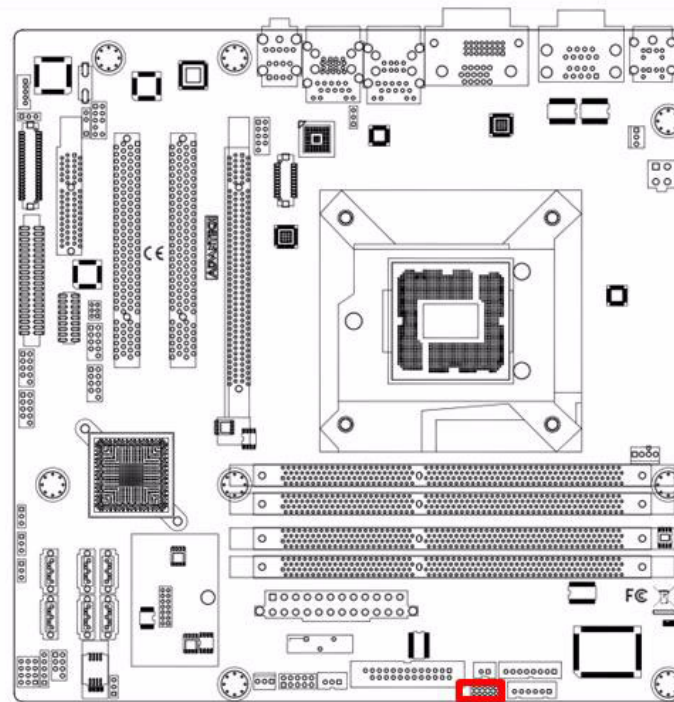

Chapter 3

BIOS Operation

3.1 Introduction

AMI BIOS has been integrated into many motherboards, and has been very popular for over a decade. People sometimes refer to the AMI BIOS setup menu as BIOS, BIOS setup or CMOS setup.

With the AMI BIOS Setup program, you can modify BIOS settings and control the special features of your computer. The Setup program uses a number of menus for making changes and turning special features on or off. This chapter describes the basic navigation of the AIMB-581 setup screens.

3.2 BIOS Setup

The AIMB-581 Series system has AMI BIOS built in, with a CMOS SETUP utility that allows users to configure required settings or to activate certain system features.

The CMOS SETUP saves the configuration in the CMOS RAM of the motherboard. When the power is turned off, the battery on the board supplies the necessary power to preserve the CMOS RAM.

When the power is turned on, press the button during the BIOS POST (Power-On Self Test) to access the CMOS SETUP screen.

Control Keys

< ↑ >> ↓ >> ← >> → >	Move to select item
----------------------	---------------------

<Enter>	Select Item
---------	-------------

<Esc>	Main Menu - Quit and not save changes into CMOS Sub Menu - Exit current page and return to Main Menu
-------	---

<Page Up/+>	Increase the numeric value or make changes
-------------	--

<Page Down/->	Decrease the numeric value or make changes
---------------	--

<F1>	General help, for Setup Sub Menu
------	----------------------------------

<F2>	Item Help
------	-----------

<F5>	Load Previous Values
------	----------------------

<F7>	Load Setup Defaults
------	---------------------

<F10>	Save all CMOS changes
-------	-----------------------

3.3 Main Menu

Press to enter AMI BIOS CMOS Setup Utility, the Main Menu will appear on the screen. Use arrow keys to select among the items and press <Enter> to accept or enter the sub-menu.

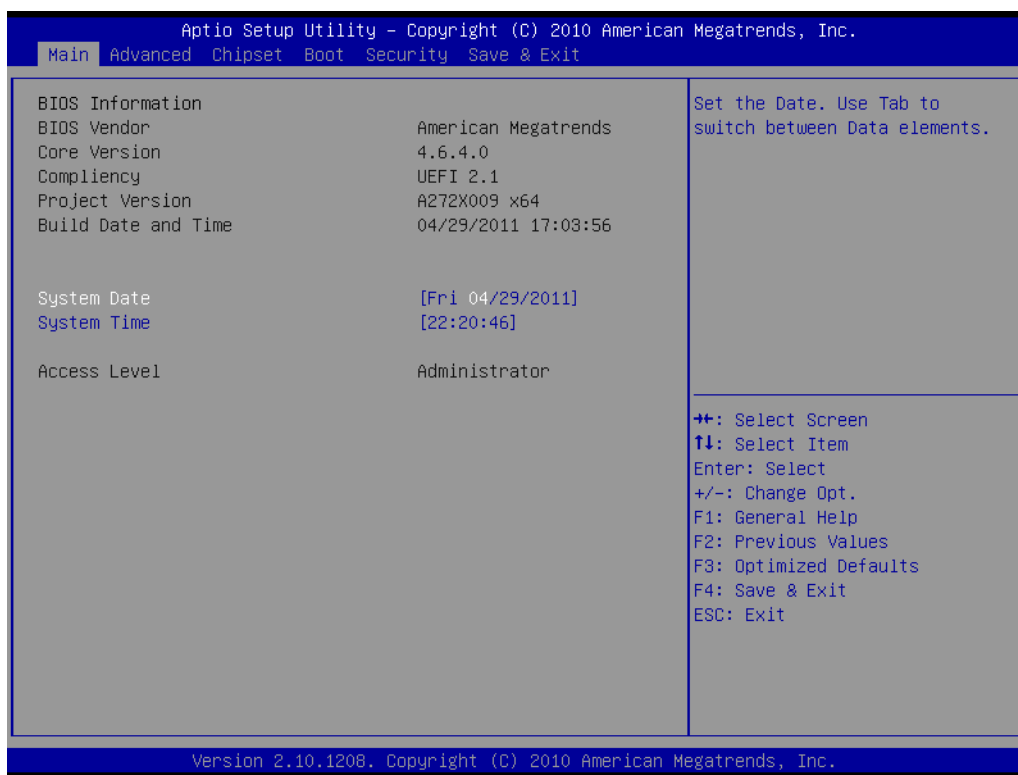

The Main BIOS setup screen has two main frames. The left frame displays all the options that can be configured. Grayed-out options cannot be configured; options in blue can. The right frame displays the key legend.

Above the key legend is an area reserved for a text message. When an option is selected in the left frame, it is highlighted in white. Often a text message will accompany it.

■ System time / System date

Use this option to change the system time and date. Highlight System Time or System Date using the <Arrow> keys. Enter new values through the keyboard. Press the <Tab> key or the <Arrow> keys to move between fields. The date must be entered in MM/DD/YY format. The time must be entered in HH:MM:SS format.

3.3.1 Advanced BIOS Features

Select the Advanced tab from the AIMB-581 setup screen to enter the Advanced BIOS Setup screen. You can select any of the items in the left frame of the screen, such as CPU Configuration, to go to the sub menu for that item. You can display an Advanced BIOS Setup option by highlighting it using the <Arrow> keys. All Advanced BIOS Setup options are described in this section. The Advanced BIOS Setup screen is shown below. The sub menus are described on the following pages.

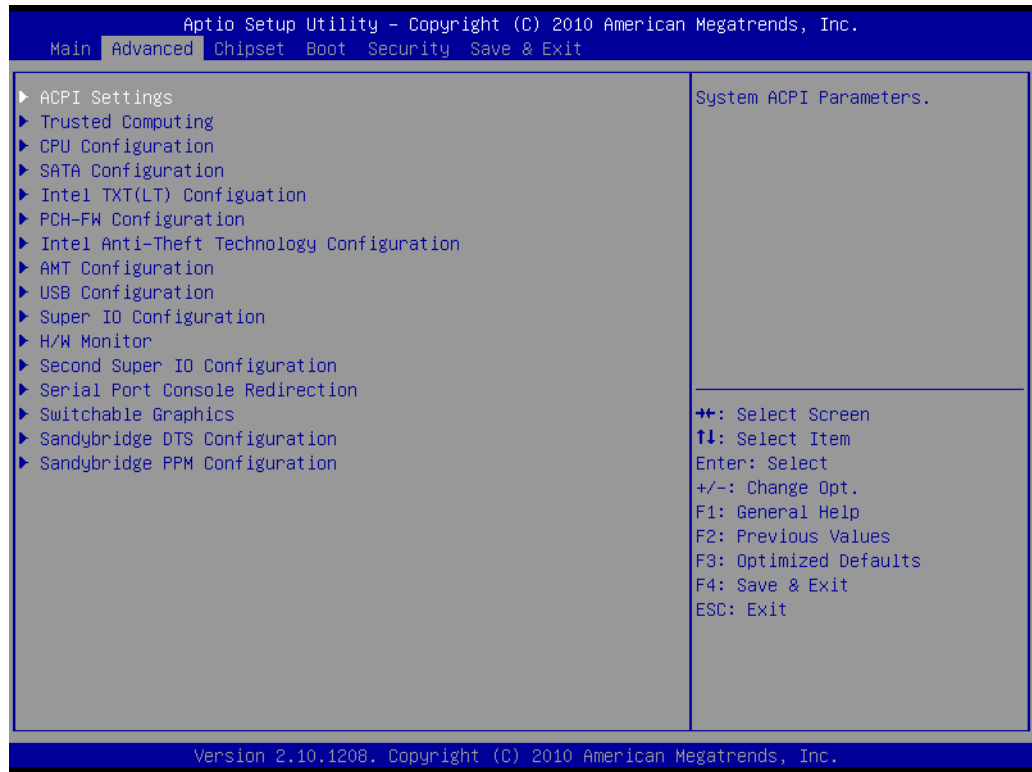

3.3.2 ACPI settings

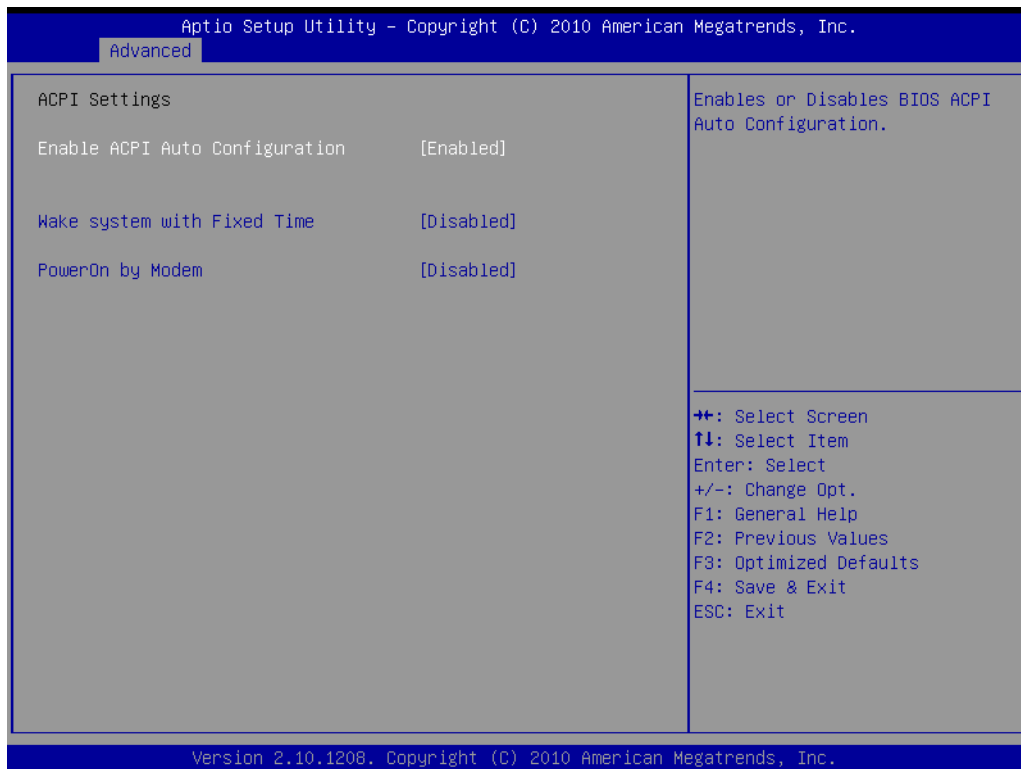

- **Enable ACPI Auto Configuration**
Enable or disable BIOS ACPI auto configuration.
- **Make System with Fixed Time**
- **PowerOn by Modem**
Allows the system to be awakened from an ACPI sleep state by a wake-up signal from a modem that supports wake-up function.

3.3.3 CPU Configuration

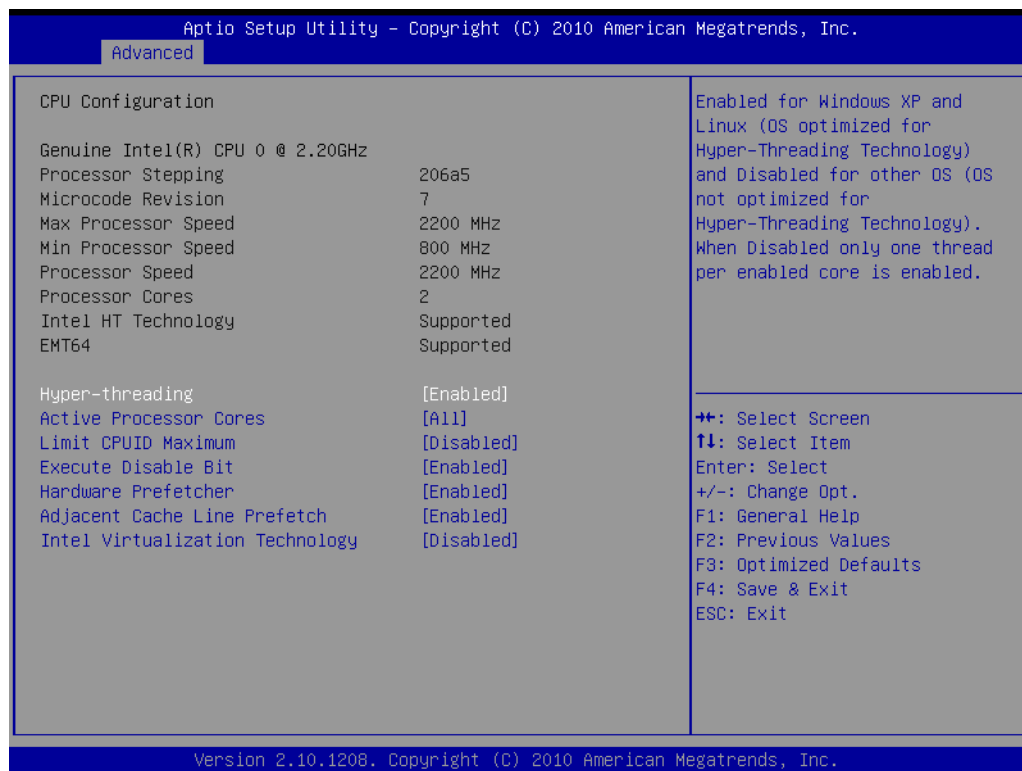

- **Hyper-Threading**
This item allows you to enable or disable Intel Hyper Threading technology.
- **Active Processor Cores**
Allows you to choose the number of CPU cores to activate in each processor package.
- **Limit CPUID Maximum**
This item allows you to limit CPUID maximum value.
- **Execute Disable Bit**
This item allows you to enable or disable the No-Execution page protection technology.
- **Hardware Prefetch**
The processor fetches data and instructions from the memory into the cache that are likely to be required in the near future. This reduces the latency associated with memory reads.
- **Adjacent Cache Line Prefetch**
This item allows users to enable or disable the adjacent cache line prefetch feature.
- **Intel Virtualization Technology**
Intel Virtualization Technology (Intel VT) is a set of hardware enhancements to Intel server and client platforms that provide software-based virtualization solutions.

Intel VT allows a platform to run multiple operating systems and applications in independent partitions, allowing one computer system can function as multiple virtual systems.

3.3.4 SATA Configuration

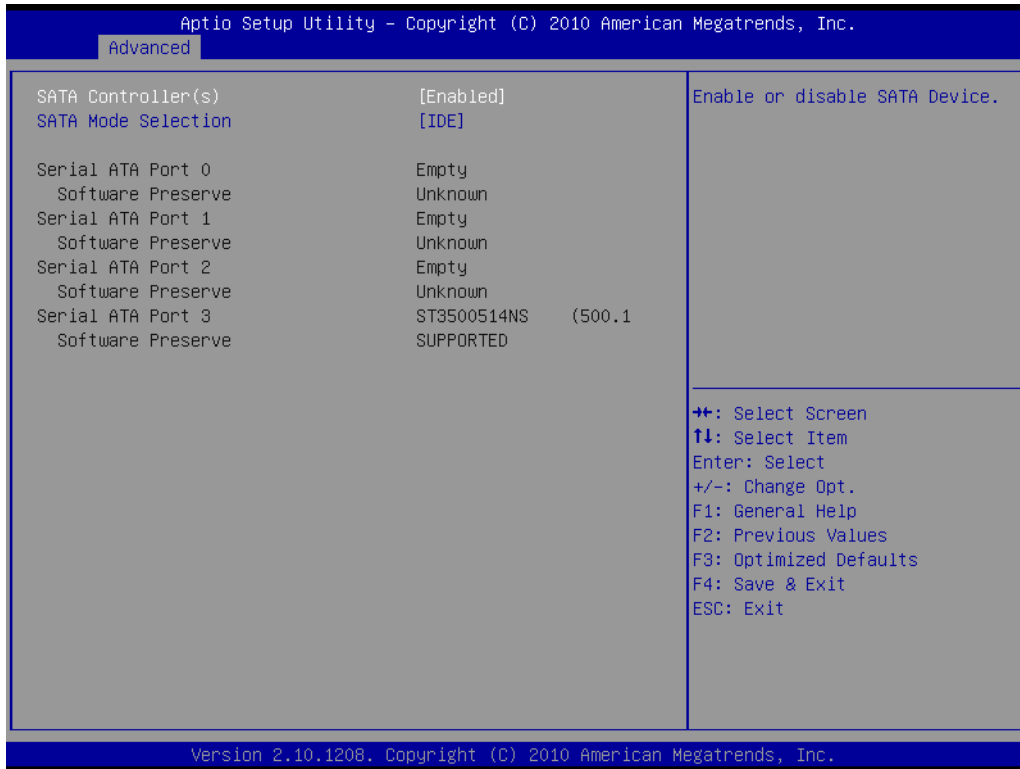

- **SATA Controllers**
This item appear only when you set SATA mode to "IDE Mode".
- **[Disabled]**
Disable SATA function.
- **SATA Mode**
This can be configured as IDE or AHCI mode.
- **Disabled**
Disable the SATA function.
- **IDE mode**
Set to [IDE mode] when you want to use the serial ATA hard disk drives as Parallel ATA physical storage devices.
- **AHCI mode**
Set to [AHCI mode] when you want the SATA hard disk drives to use the AHCI (Advanced Host Controller Interface). The AHCI allows the onboard storage driver to enable advanced serial ATA features that increase storage performance on random workloads by allowing the drive to internally optimize the order of commands.

3.3.5 Intel TXT Configuration

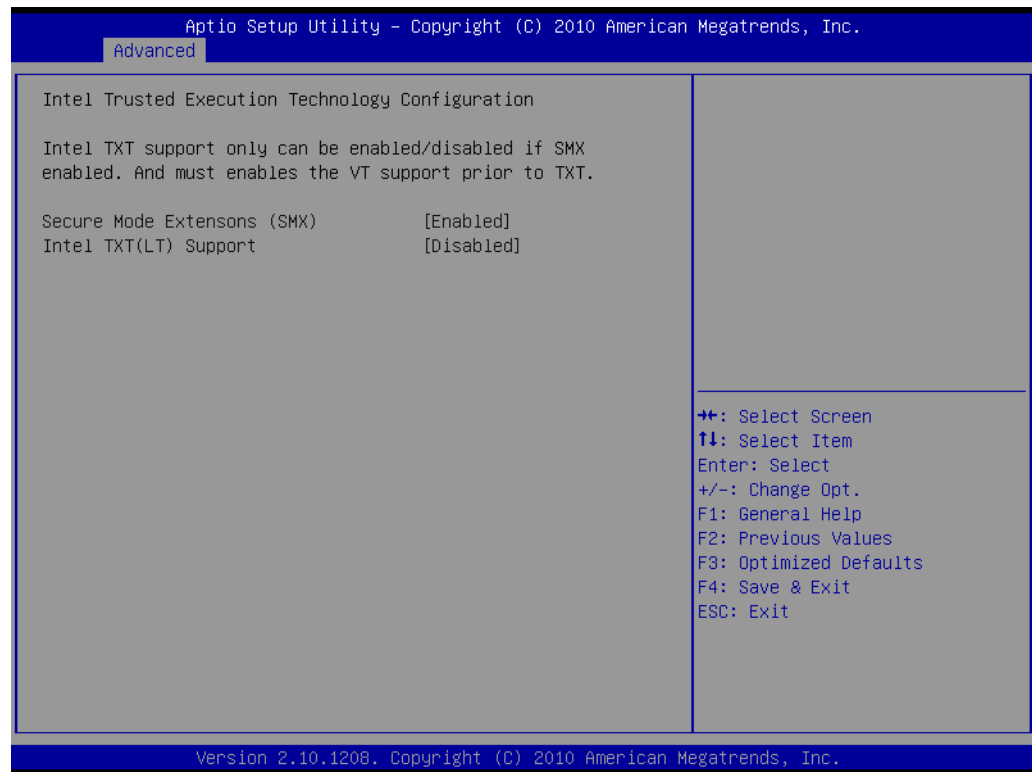

- **Secure Mode Extension (SMX)**
- **Intel TXT Configuration**
This item allow you to enable or disable Intel Trusted Execution Technology

3.3.6 USB Configuration

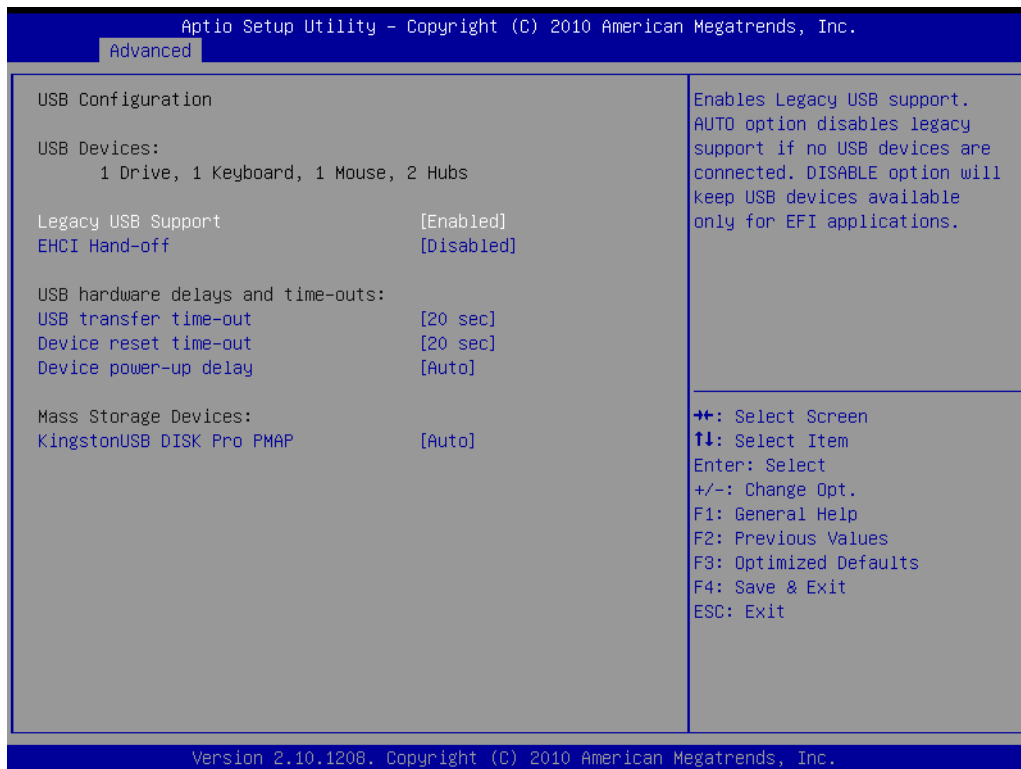

- **Legacy USB Support**
Enables support for legacy USB. Auto option disables legacy support if no USB devices are connected.
- **EHCI Hand-off**
This is just a workaround item under OS without EHCI hand-off support.
- **Device Reset time out**
USB mass storage device start unit command time out.
- **Mass Storage Devices**
Show the USB mass storage device detail information.

3.3.7 Super IO Configuration

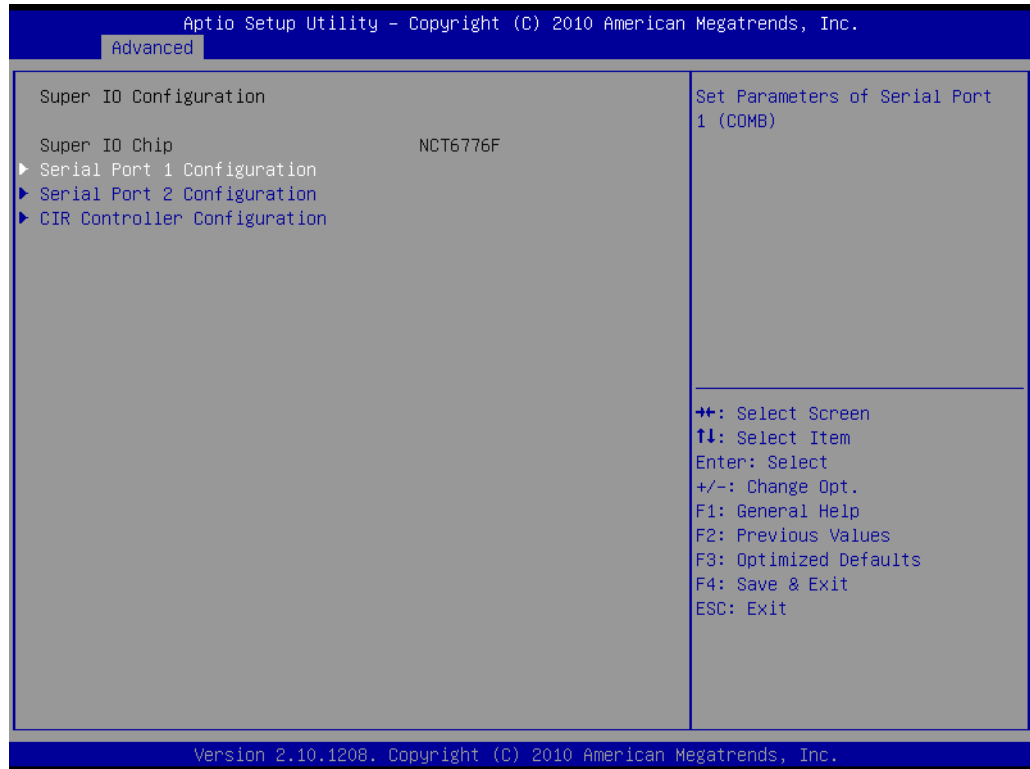

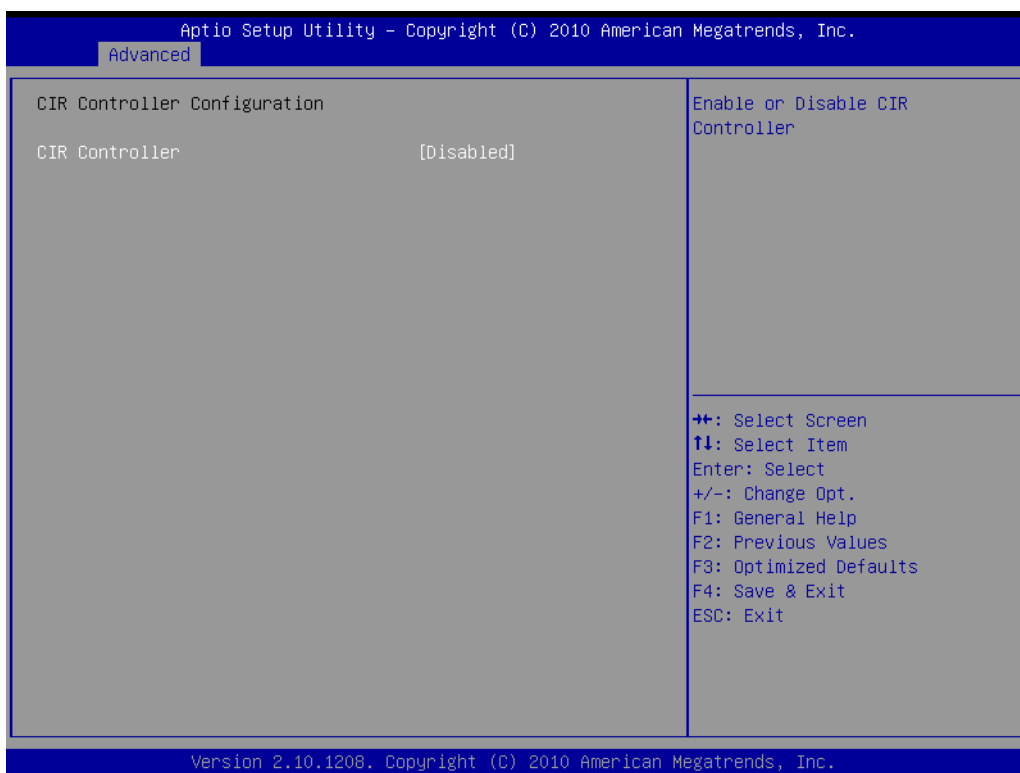

- **Serial Port 1/2 Configuration**
Serial port 1/2 IRQ /IO/ mode resource configuration. Users can choose IRQ,IO and MODE.
- **CIR Controller Configuration**

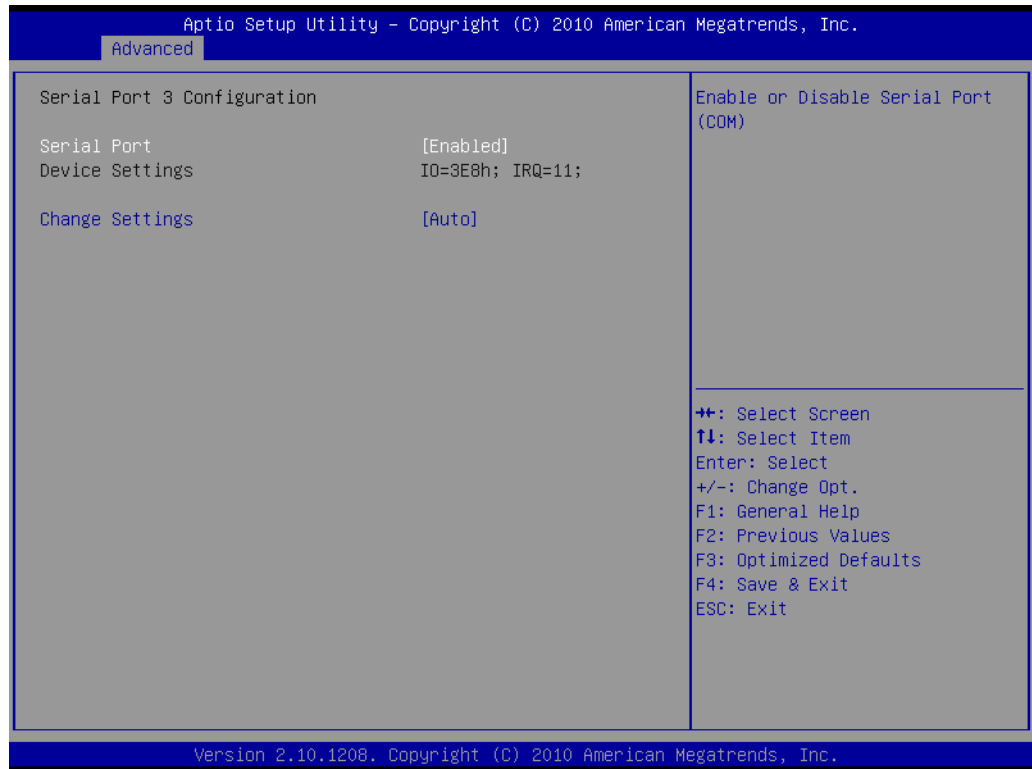
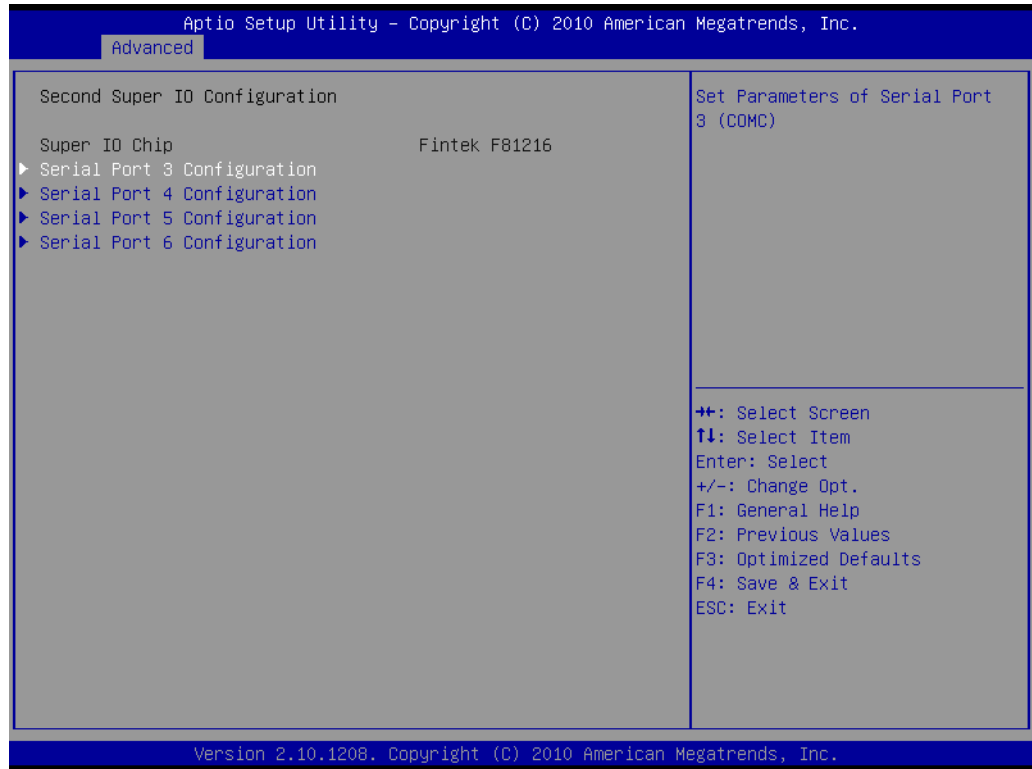

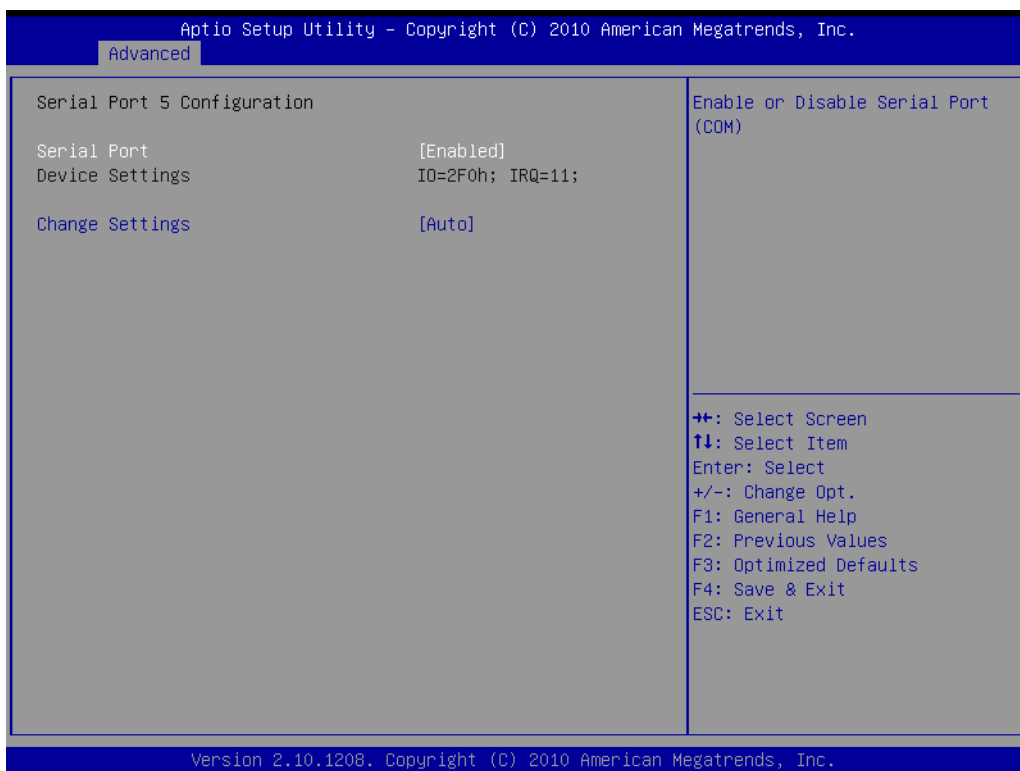
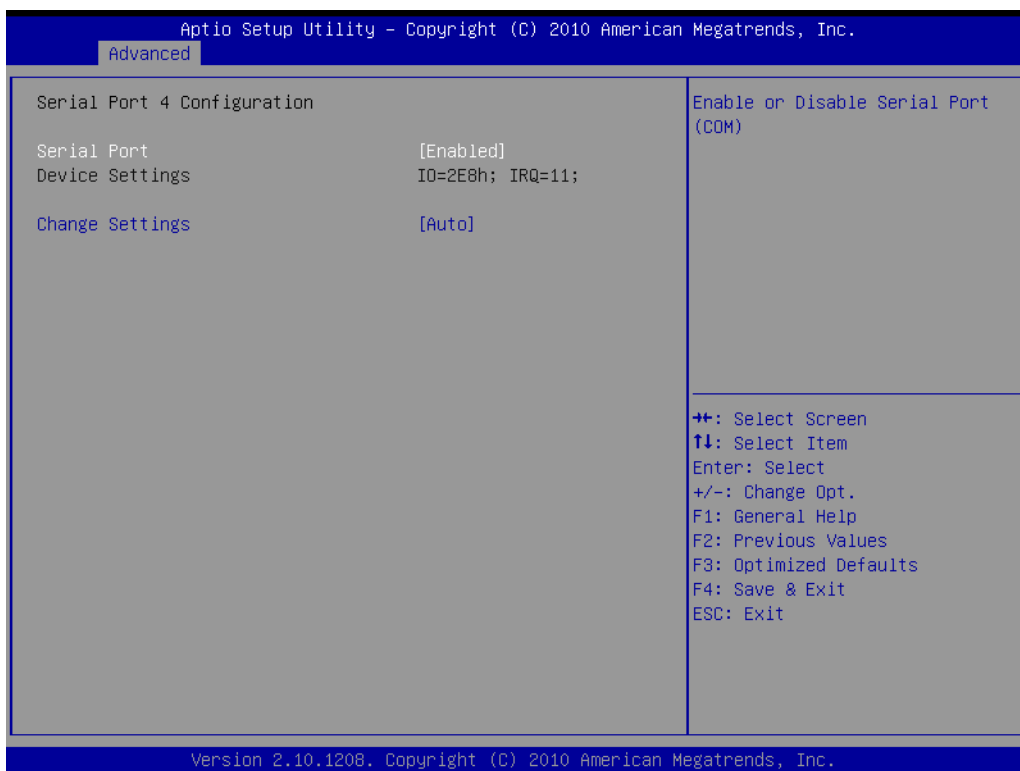

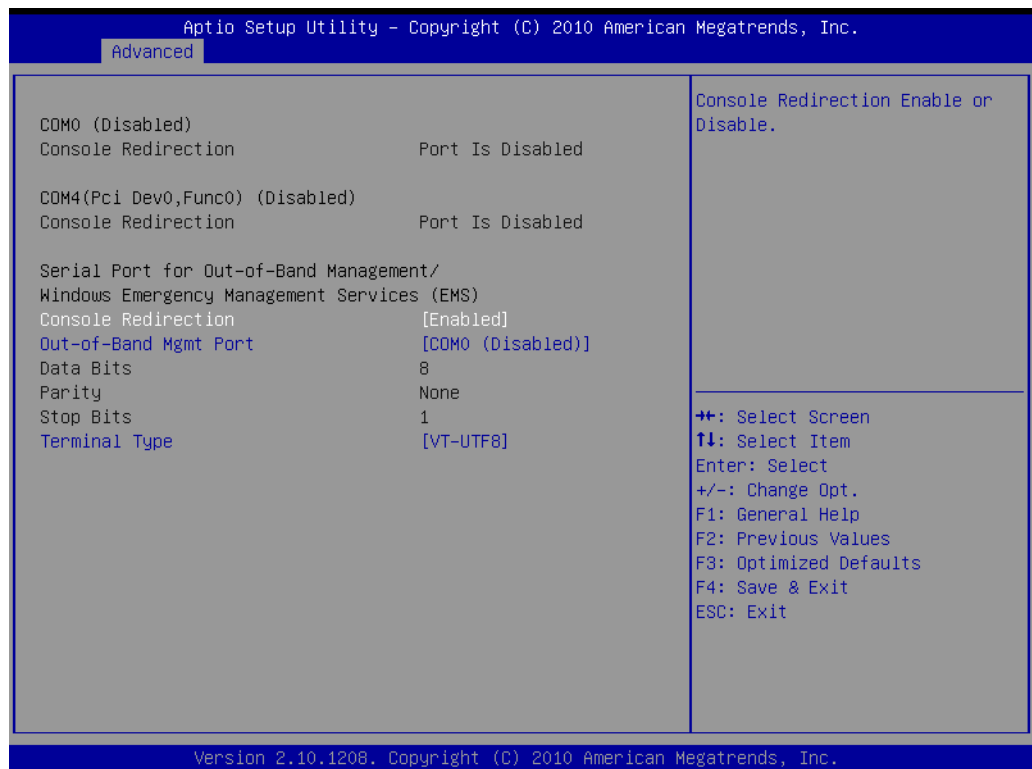
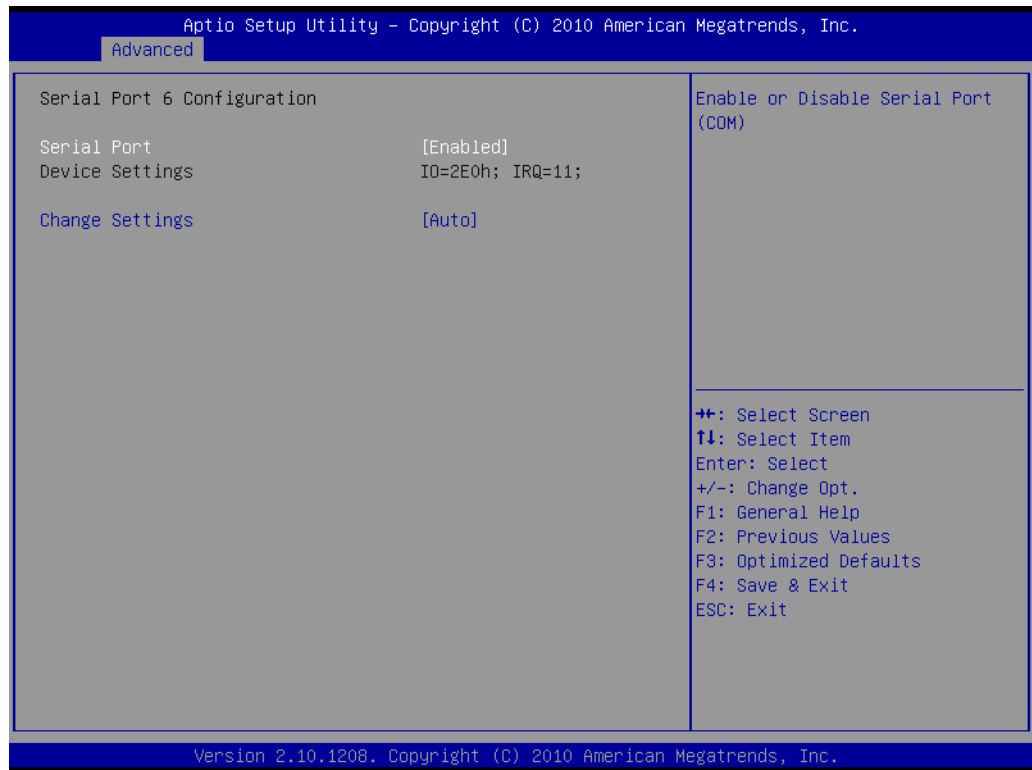

- **Control Redirection**

This item allows users to enable or disable console redirection or Microsoft Windows Emergency Management Services (EMS)

- **Out-of-Band Mgmt Port**

Select the port for Microsoft Windows Emergency Management Services (EMS) to allow for remote management of a Windows Server OS.

- **Terminal Type**

VT-UTF8 is the preferred terminal type for out-of-band management. The next best choice is VT100+ and then VT100. See above, in Console Redirection Settings page, for more Help with Terminal Type/Emulation.

3.3.8 H/W Monitor

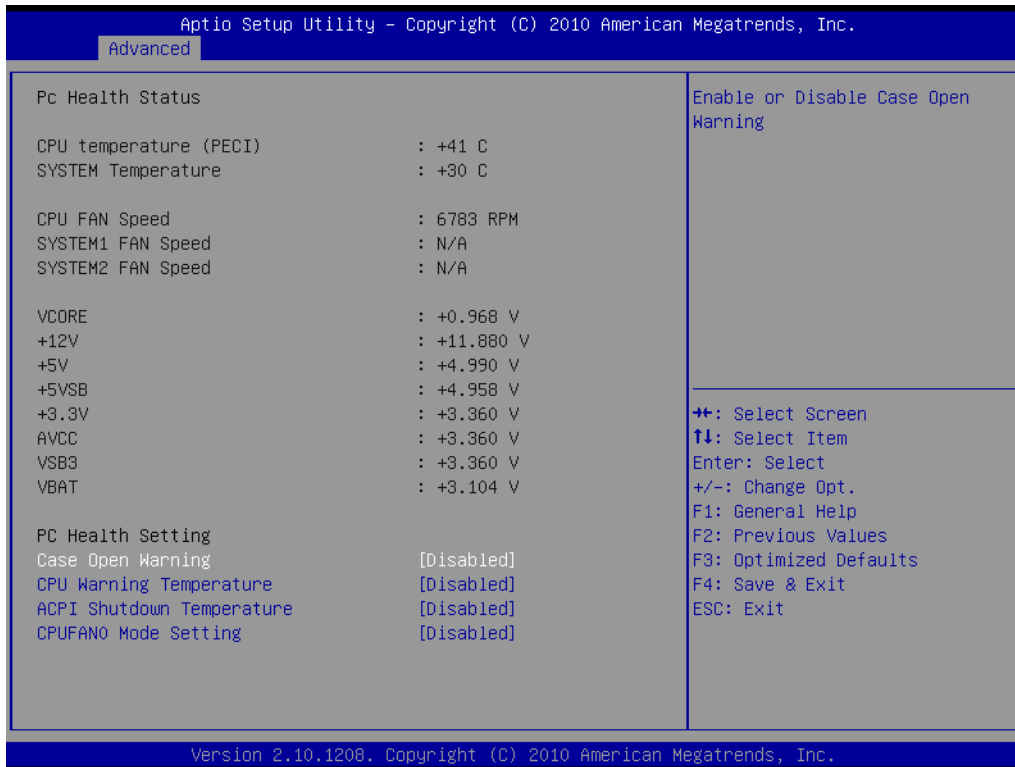

- **Case open Warning**

To show warning message beep sound when case been opened.

- **Shutdown Temperature**

This option allows user to set the CPU temperature at which the system will automatically shut down to prevent CPU overheat damage.

- **Warning Temperature**

Use this to set the CPU warning temperature threshold. When the system CPU reaches the warning temperature, the buzzer will beep.

- **CPUFAN0 Mode Setting**

To enable or disable the smart fan control feature.

3.3.9 Intelligent Power Sharing

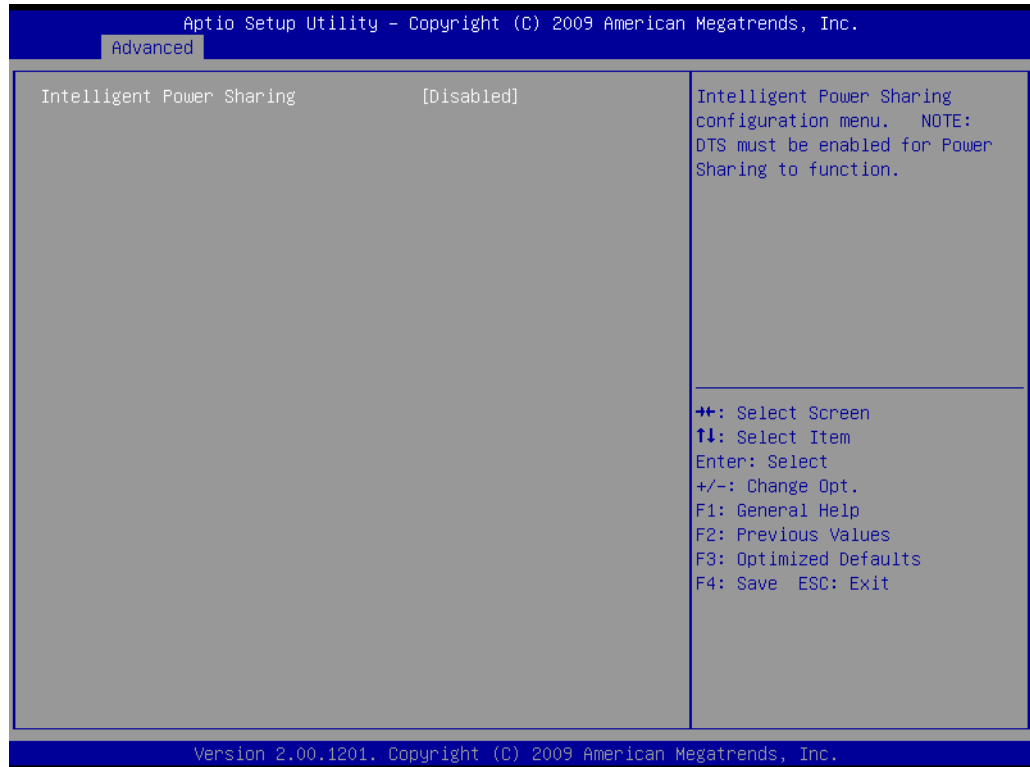

- **Intelligent Power Sharing**

This item allows you to enable or disable Intelligent Power Sharing function.

3.3.10 AMT Configuration

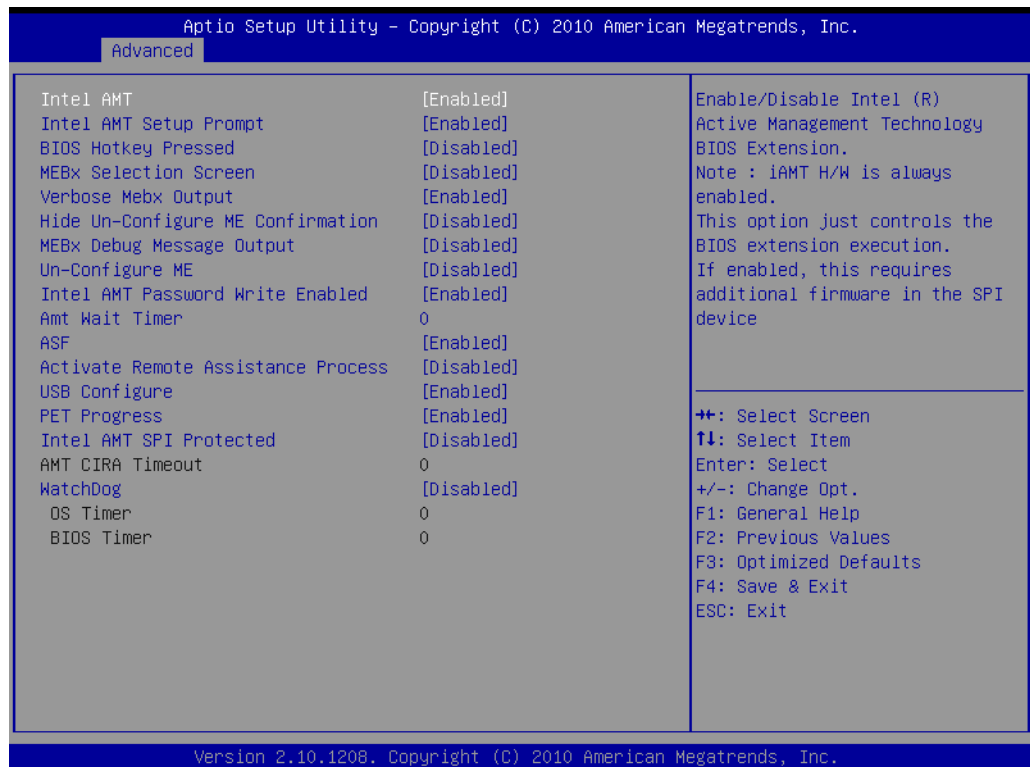

- **Intel AMT**
This item allows users to enable or disable Intel AMT BIOS extension.
- **Intel AMT Setup Prompt**
This item allows users to enable or disable Intel AMT Setup prompt.
- **BIOS Hotkey Pressed**
This item allows users to enable or disable BIOS hotkey pressed.
- **MEBx Selection Screen**
This item allows users to enable or disable MEBx selection screen.
- **Verbose MEBx Output**
This item allows users to enable or disable MEBx Output.
- **Hide Un-configuration ME confirmation**
This item allows users to hide un-configured ME without password confirmation prompt.
- **MEBx Debug Message Output**
This item allows users to enable or disable MEBx debug message.
- **Un-Configured ME**
This item allows users to Un-configure ME without password.
- **Intel AMT Password Write Enabled**
This item allows users to enable or disable Intel AMT password write.
- **Amt Wait Timer**
Set timer to wait before sending ASF_GET_BOOT_OPTIONS.
- **Activated Remote Assistance Process**
This item allows users to enable or disable Alert Specification Format.
- **USB Configure**
This item allows users to enable or disable USB Configure Function.
- **PET Progress**
This item allows users to enable or disable PET event progress to receive PET events or not.
- **Intel AMT SPI Protected**
This item allows users to enable or disable Intel AMT SPI write protect.
- **AMT CIRA Timeout**
OEM defined time out for MPS connection to be established.
- **Watchdog**
This item allows users to enable or disable WatchDog Timer.
- **OS Timer**
Sets OS Watchdog Timer.
- **BIOS Timer**
Sets BIOS Watchdog timer.

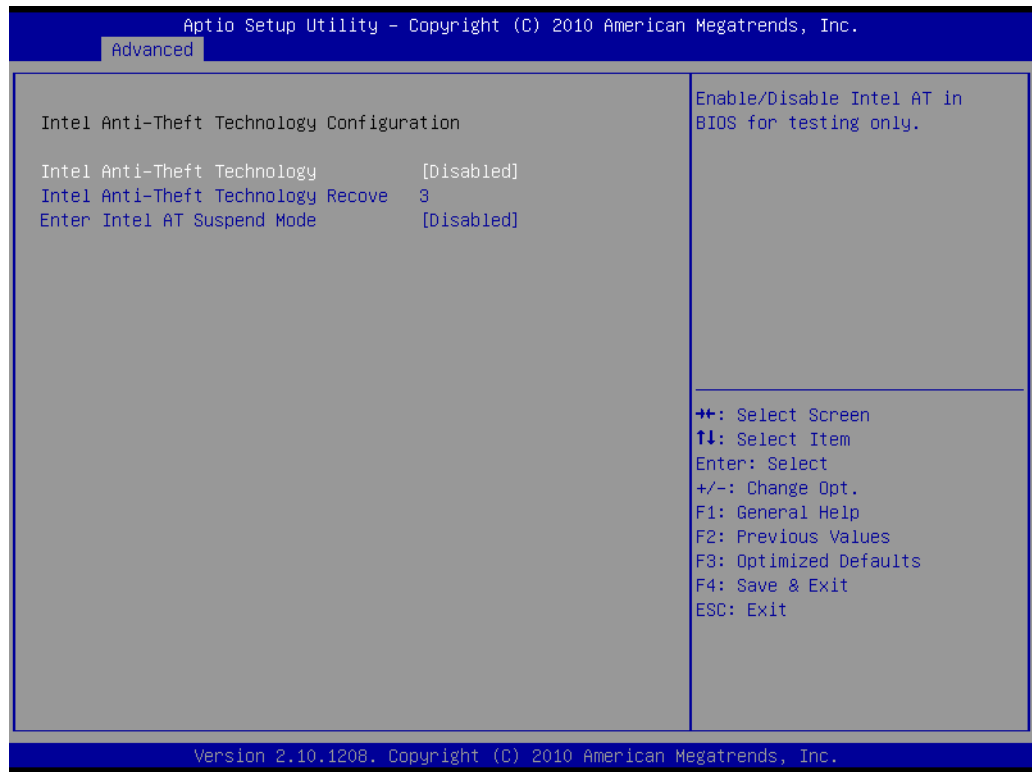

■ **Intel Anti-Theft Technology**

This item allows users to enable or disable Intel® Anti-Theft Technology (Intel® AT), which helps stop laptop theft by making computers useless to thieves with immediate shut down.

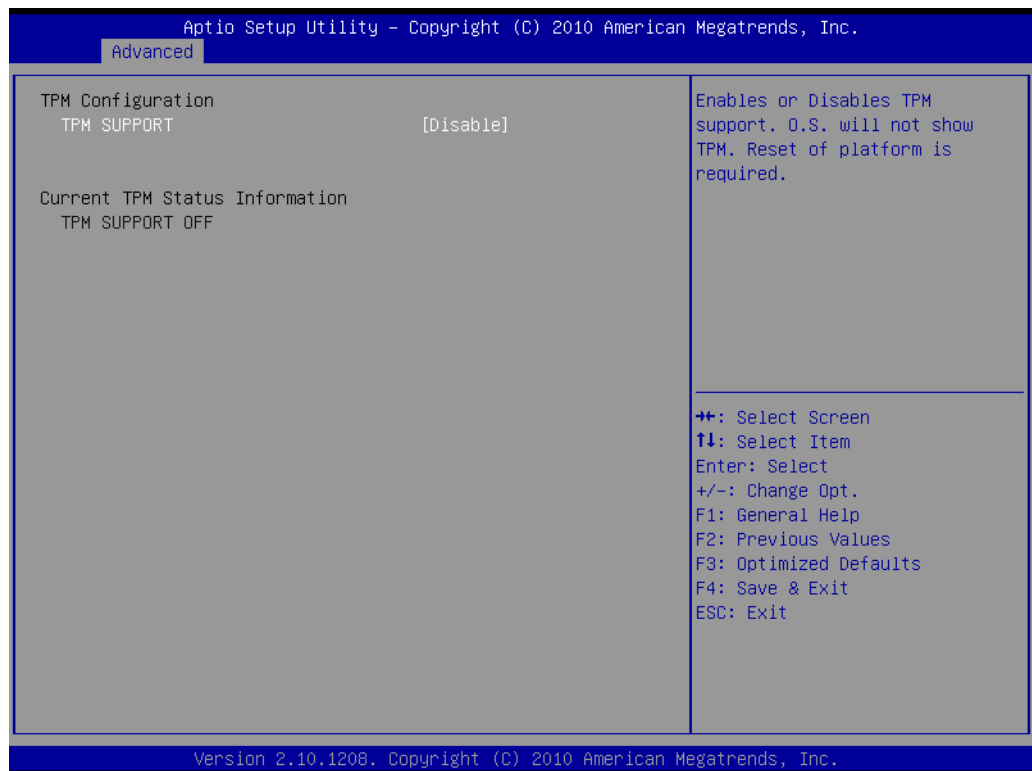

■ TPM Support

This item allows users to enable or disable Trusted Platform Module function.

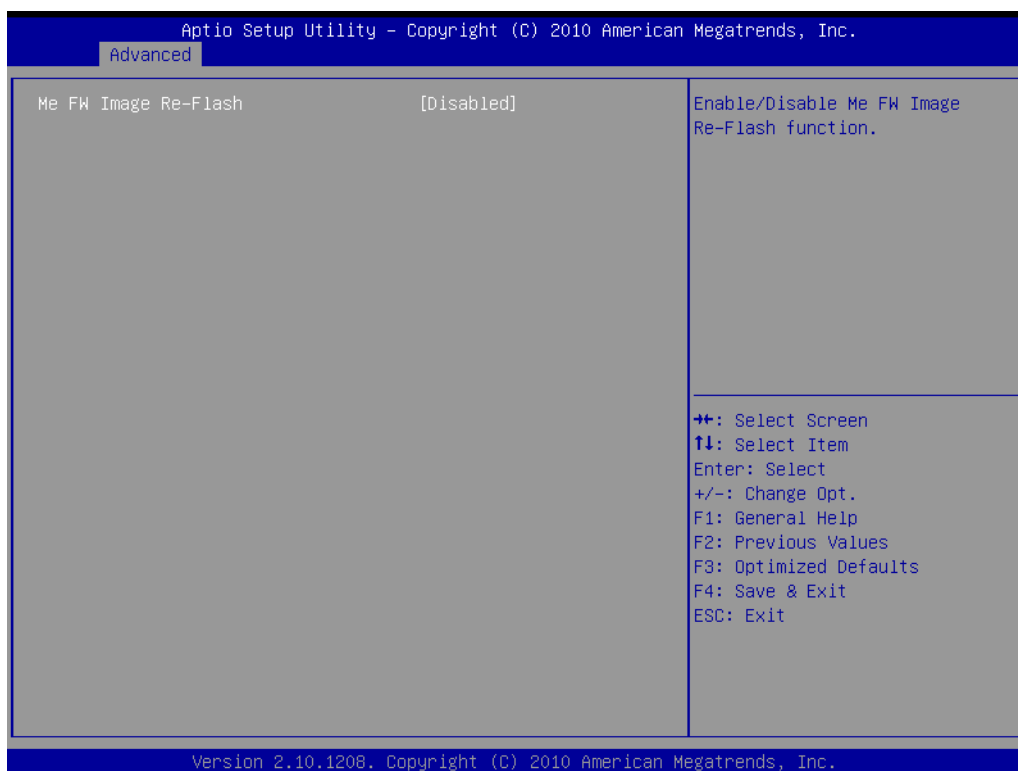

■ ME FW Image Re-Flash

This item allows users to enable or disable Me FW image re-flash function.

3.3.11 Switchable Graphics

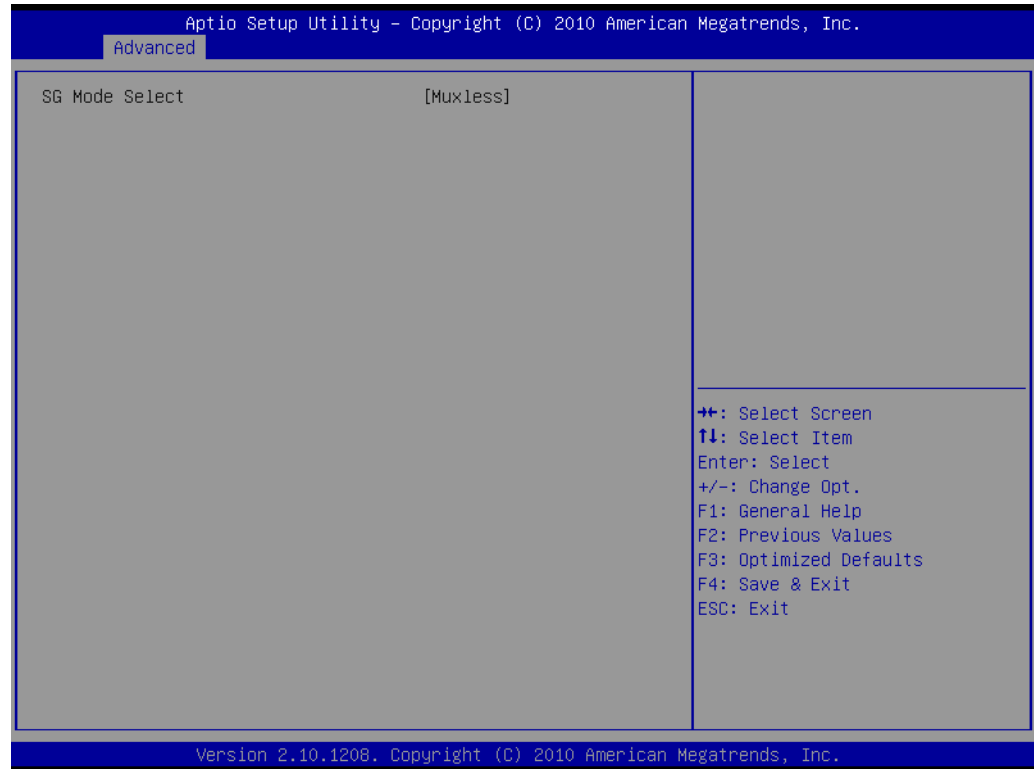

- **SG Mode Select**
This item allows users to select switchable graphics mode.

3.4 Chipset Configuration Setting

Select the chipset tab from the BIOS setup screen to enter the Chipset Setup screen. Users can select any item in the left frame of the screen, such as PCI express Configuration, to go to the sub menu for that item. Users can display a Chipset Setup option by highlighting it using the <Arrow> keys. All Chipset Setup options are described in this section. The Chipset Setup screens are shown below. The sub menus are described on the following pages.

3.4.1 PCH-IO Configuration

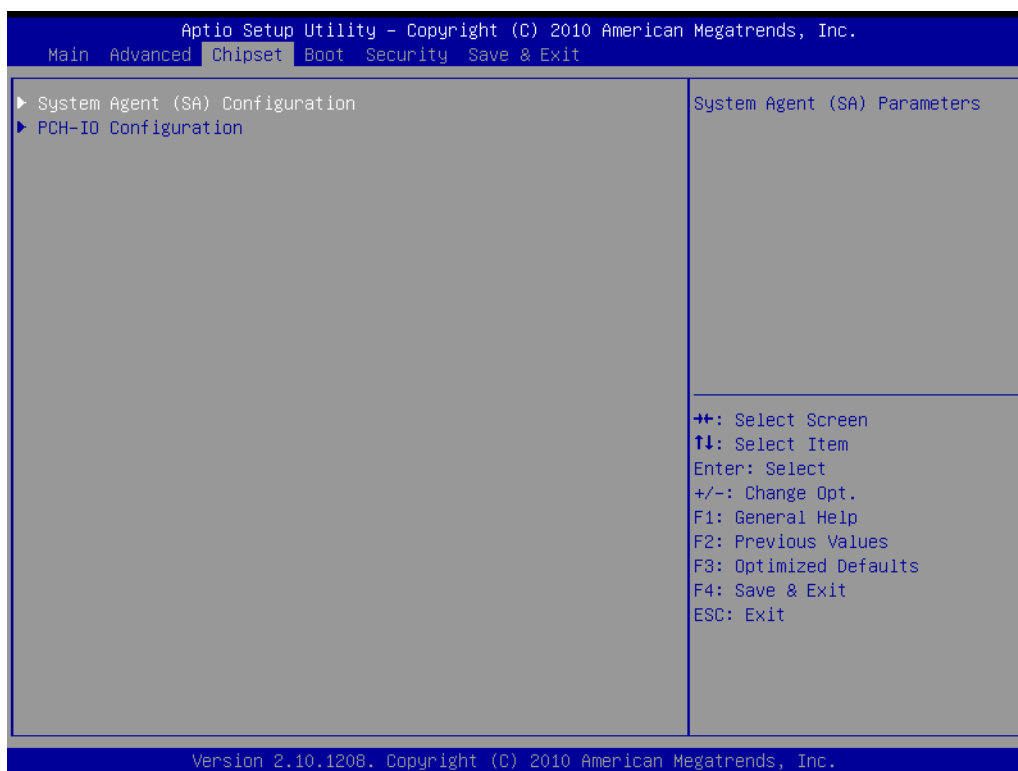

- **PCH Lan Controller**
Enable or disable PCH LAN controller.
- **Wake on LAN**
Enable or disable PCH LAN wake up from sleep state.
- **Azalia Controller**
Enable or disable the azalia controller.
- **Azalia Internal HDMI codec**
Enable or disable the azalia internal HDMI codec.
- **High Precision Timer**
Enable or disable the high precision timer.
- **SLP_S4 Assertion Width**
This item allows users to set a delay of sorts.
- **Restore AC Power Loss**
This item allows users to select off, on and last state.

3.4.2 North Bridge Configuration

3.4.2.1 System Agent(SA) Configuration

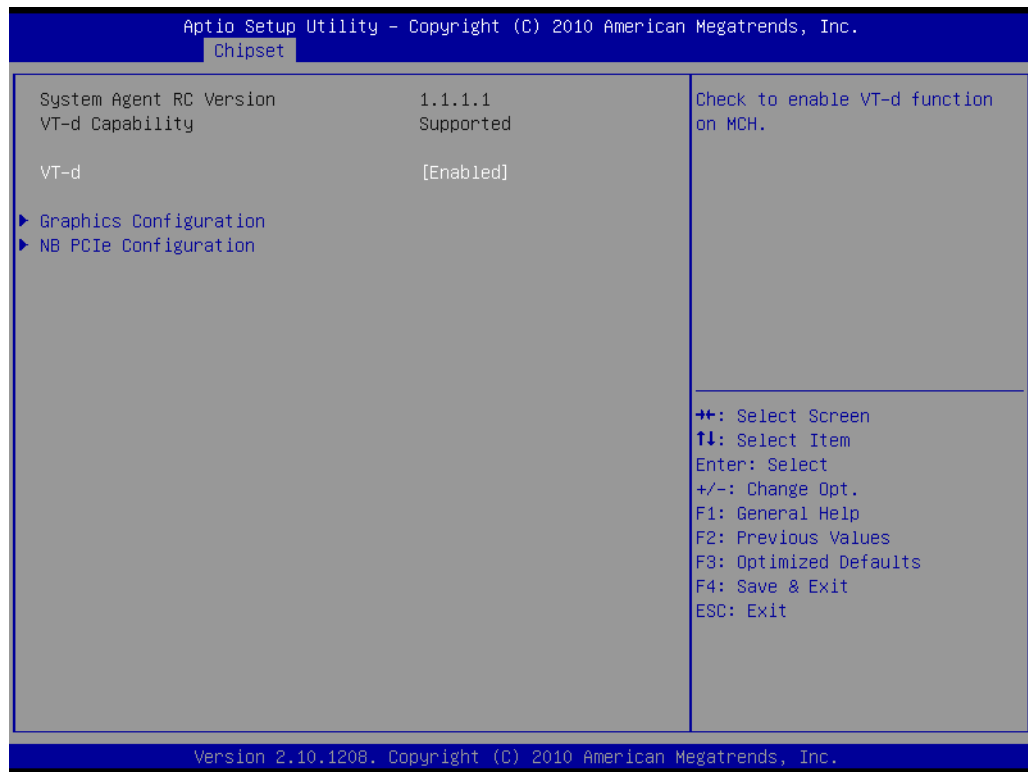

- **VT-d**
This item allows users to enable or disable VT-d.
- **NB PCIe Configuration**

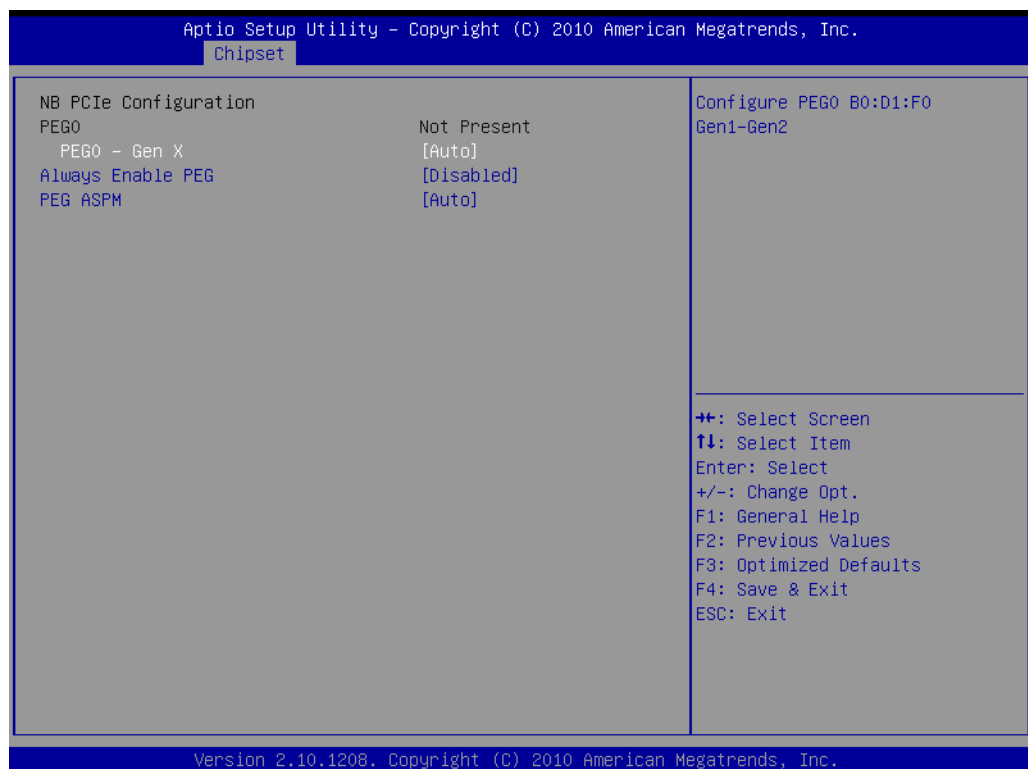

- **PEG0 -Gen x**
Select PEG0 speed.
- **Always enabled PEG.**
This item allows users to enable or disable PEG always.
- **PEG ASPM**
This item allows users to enable or disable PEG ASPM.

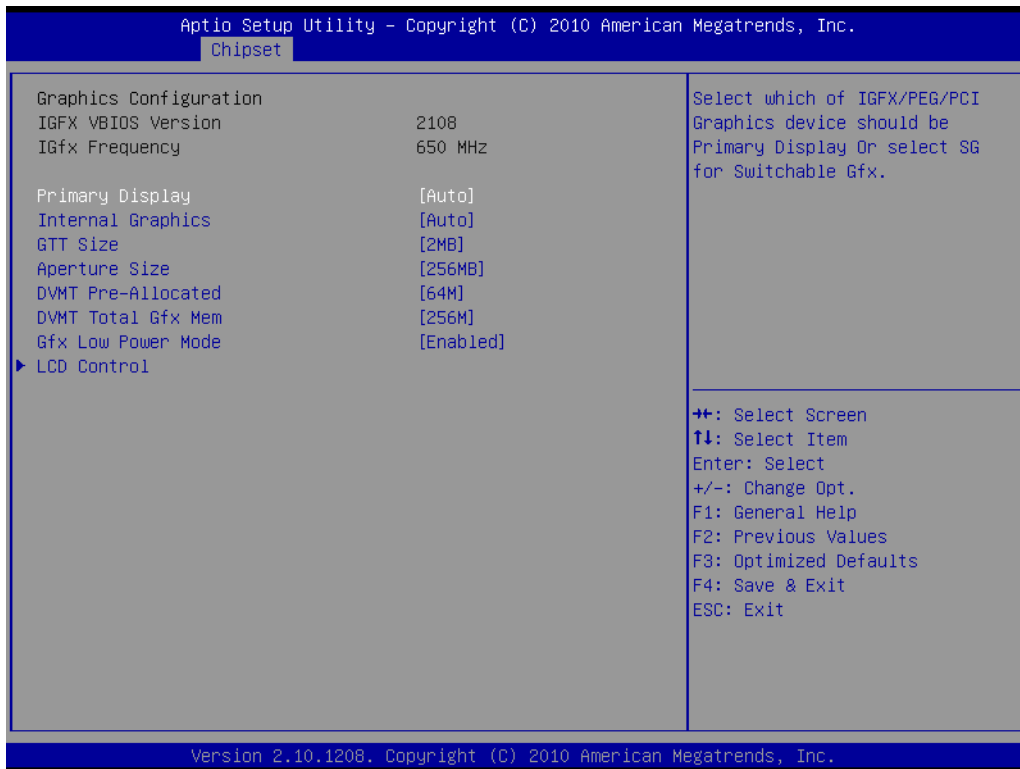

- **Primary Display**
This item allows users to select which graphic controllers to use as the primary boot device.

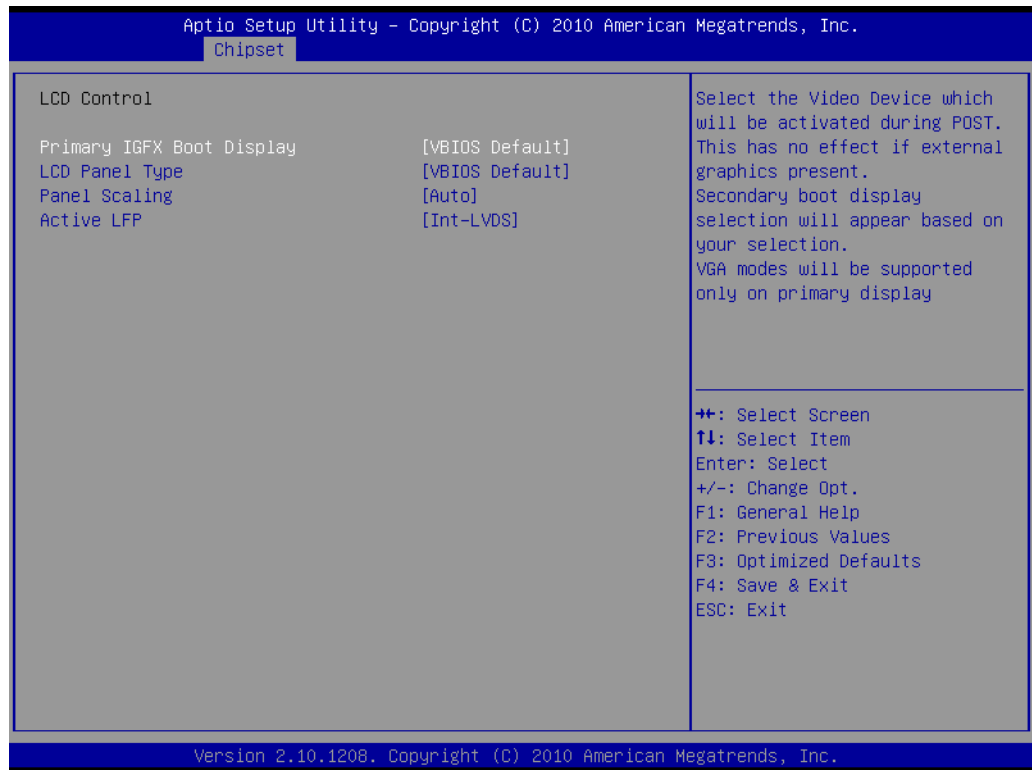

- **Primary IGFX Boot Display**
Select boot display device at post stage.
- **LCD Panel Type**
This item allows users to select panel resolution.
- **Panel Scaling**
This item allows users to enable or disable panel scaling.
- **Active LFP**
This item allows users to select LFP configuration.

3.4.3 South Bridge Configuration

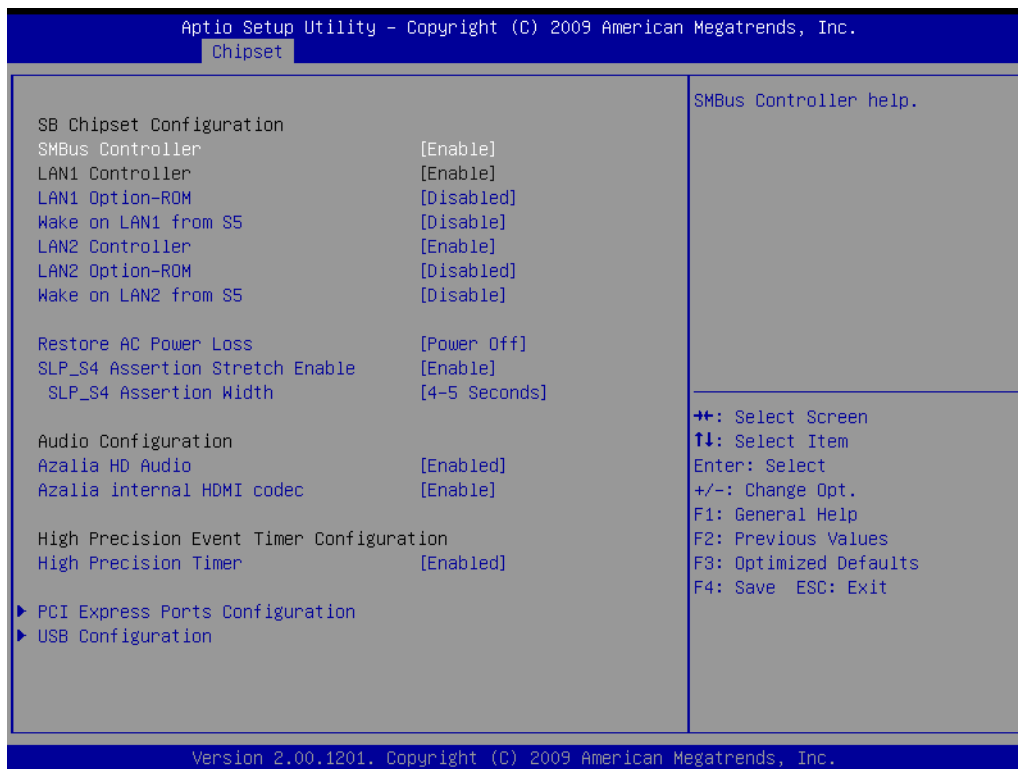

- **SMBus Controller**
Disable/enable the system SMBUS function.
- **LAN1 Controller**
Enables or disables the GbE controller.
- **LAN1 Option-ROM**
Enables or disables GbE LAN boot.
- **Wake on LAN1 from S5**
Enables or disables GbE LAN wake up from S5 function.
- **LAN2 Controller**
Enables or disables the GbE controller.
- **LAN2 Option-ROM**
Enables or disables GbE LAN boot.
- **Wake on LAN2 from S5**
Enables or disables GbE LAN wake up from S5 function.
- **Restore AC Power Loss**
The system goes into on/off state after an AC power loss.
- **SLP_S4 Assertion Stretch Enable**
This item allows you to set a delay of a set number of seconds.
- **Azalia HD Audio**
Enables or disables the HD Audio controller.
- **Azalia internal HDMI codec**
Enables or disables the internal HDMI codec.
- **High Precision Timer**
Enables or disables High Precision Event Timer (HPET)

3.4.4 PCI Express Ports Configuration

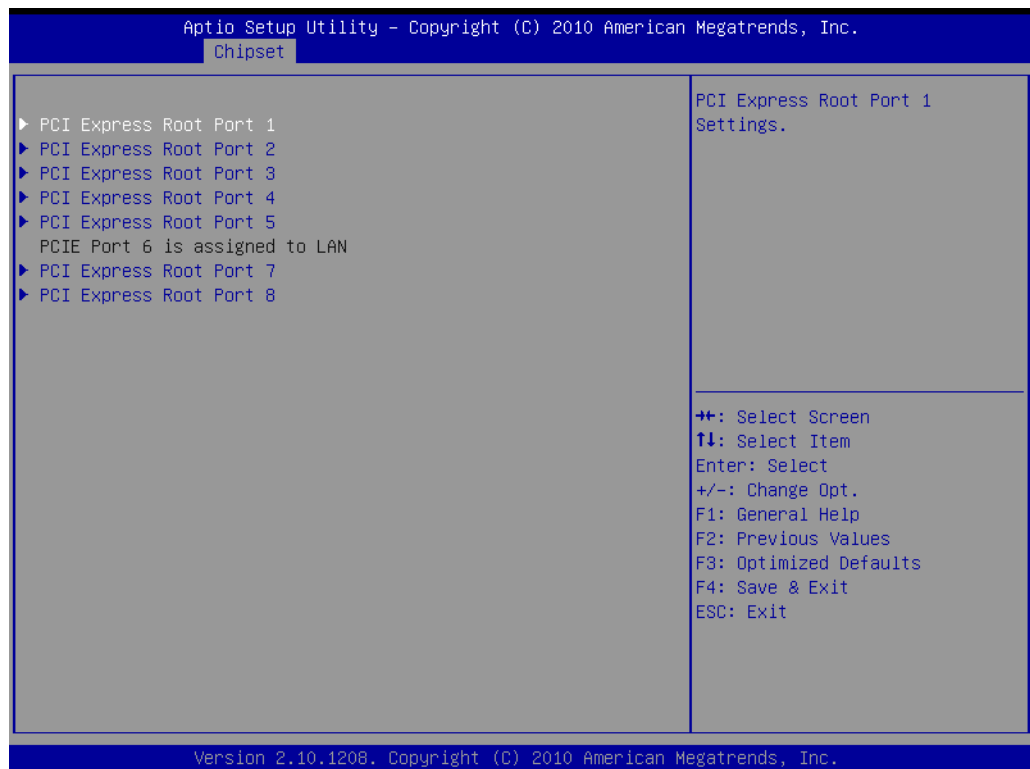
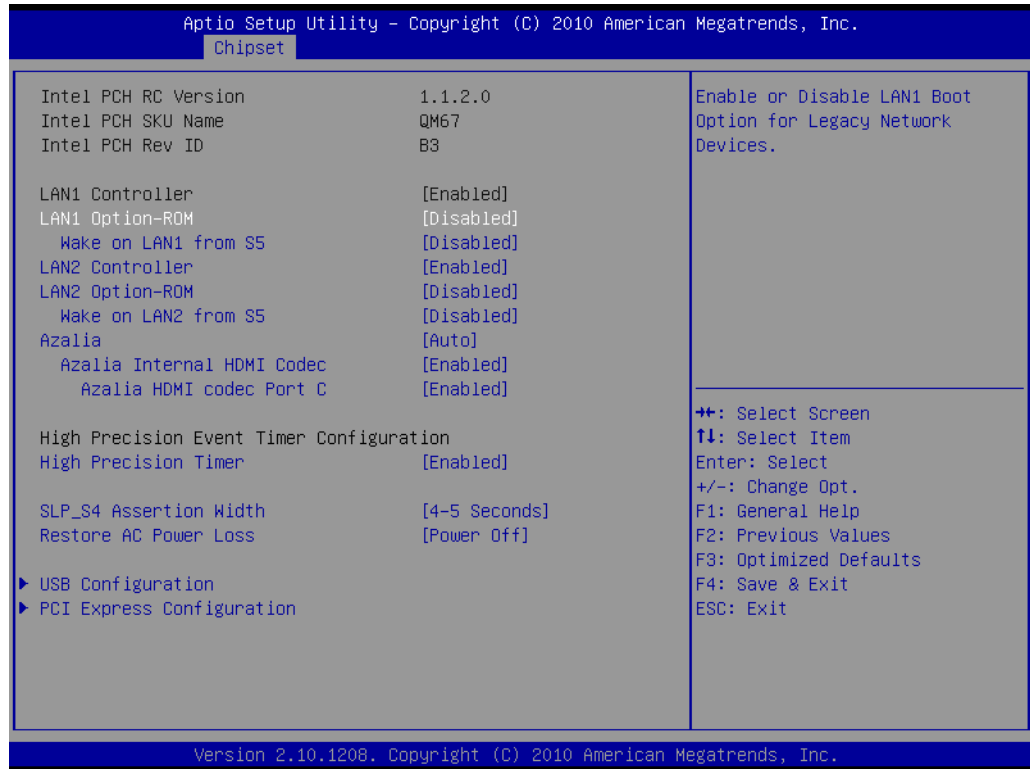

- **PCI Express Ports Configuration**
Disable / Enable the PCI Express ports.

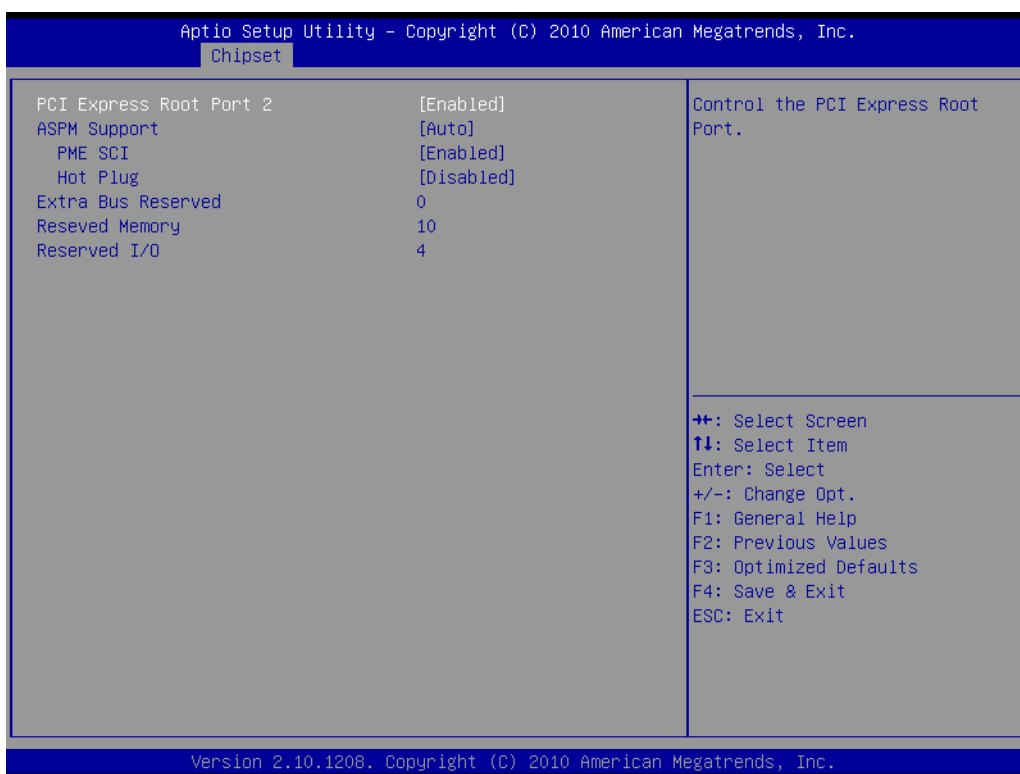
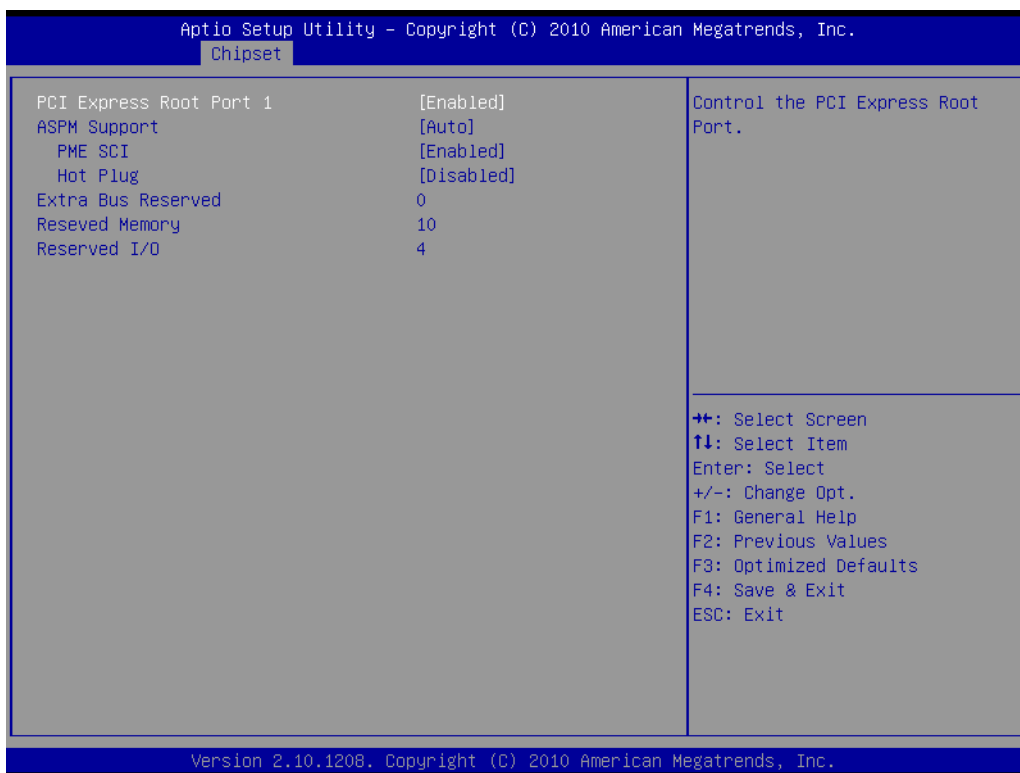

Aptio Setup Utility - Copyright (C) 2010 American Megatrends, Inc.

Chipset

PCI Express Root Port 3	[Enabled]	Control the PCI Express Root Port.
ASPM Support	[Auto]	
PME SCI	[Enabled]	
Hot Plug	[Disabled]	
Extra Bus Reserved	0	
Reseved Memory	10	
Reserved I/O	4	

⇧⇧: Select Screen
 ⇧↓: Select Item
 Enter: Select
 +/-: Change Opt.
 F1: General Help
 F2: Previous Values
 F3: Optimized Defaults
 F4: Save & Exit
 ESC: Exit

Version 2.10.1208. Copyright (C) 2010 American Megatrends, Inc.

Aptio Setup Utility - Copyright (C) 2010 American Megatrends, Inc.

Chipset

PCI Express Root Port 4	[Enabled]	Control the PCI Express Root Port.
ASPM Support	[Auto]	
PME SCI	[Enabled]	
Hot Plug	[Disabled]	
Extra Bus Reserved	0	
Reseved Memory	10	
Reserved I/O	4	

⇧⇧: Select Screen
 ⇧↓: Select Item
 Enter: Select
 +/-: Change Opt.
 F1: General Help
 F2: Previous Values
 F3: Optimized Defaults
 F4: Save & Exit
 ESC: Exit

Version 2.10.1208. Copyright (C) 2010 American Megatrends, Inc.

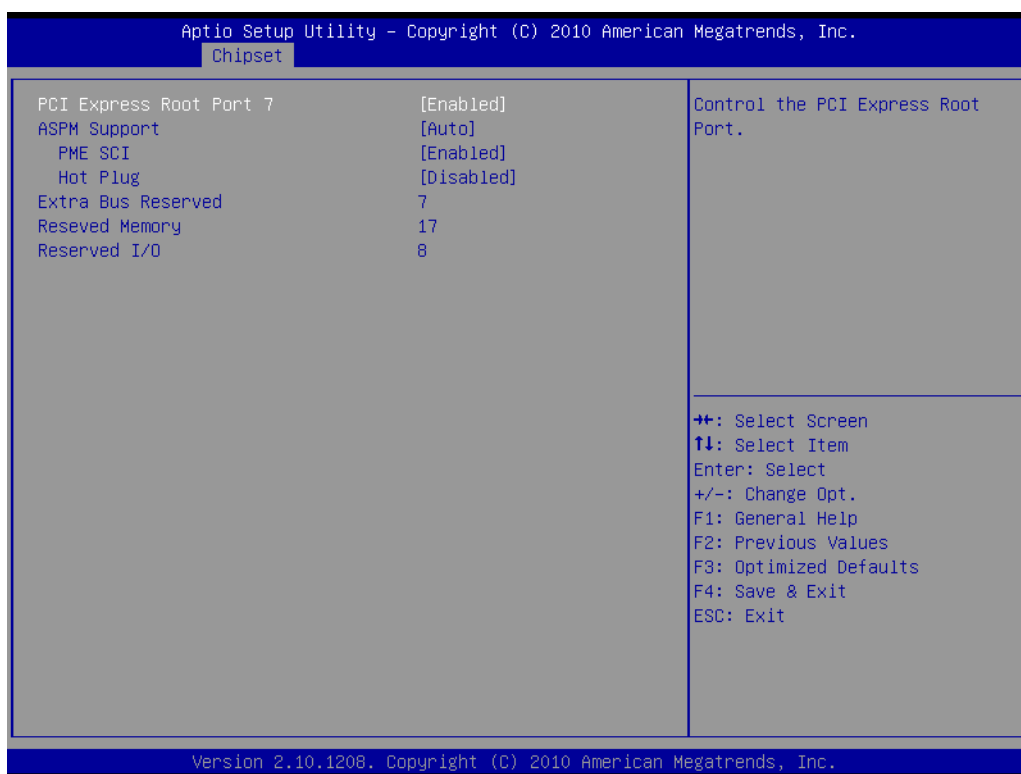
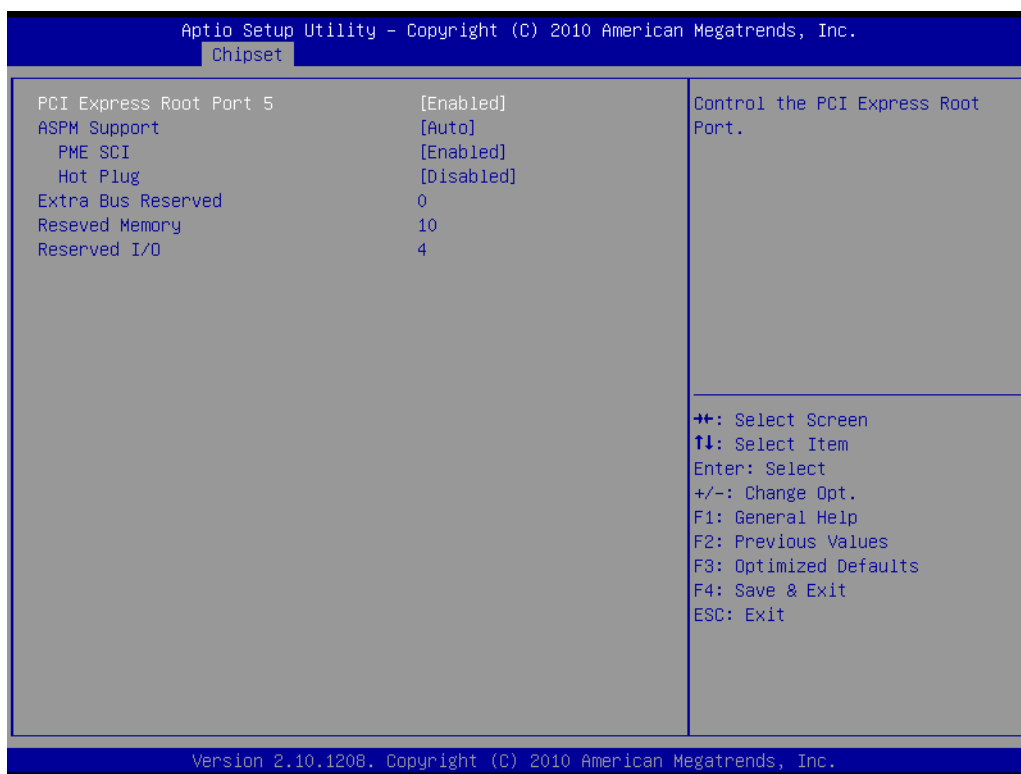

3.4.5 USB Configuration

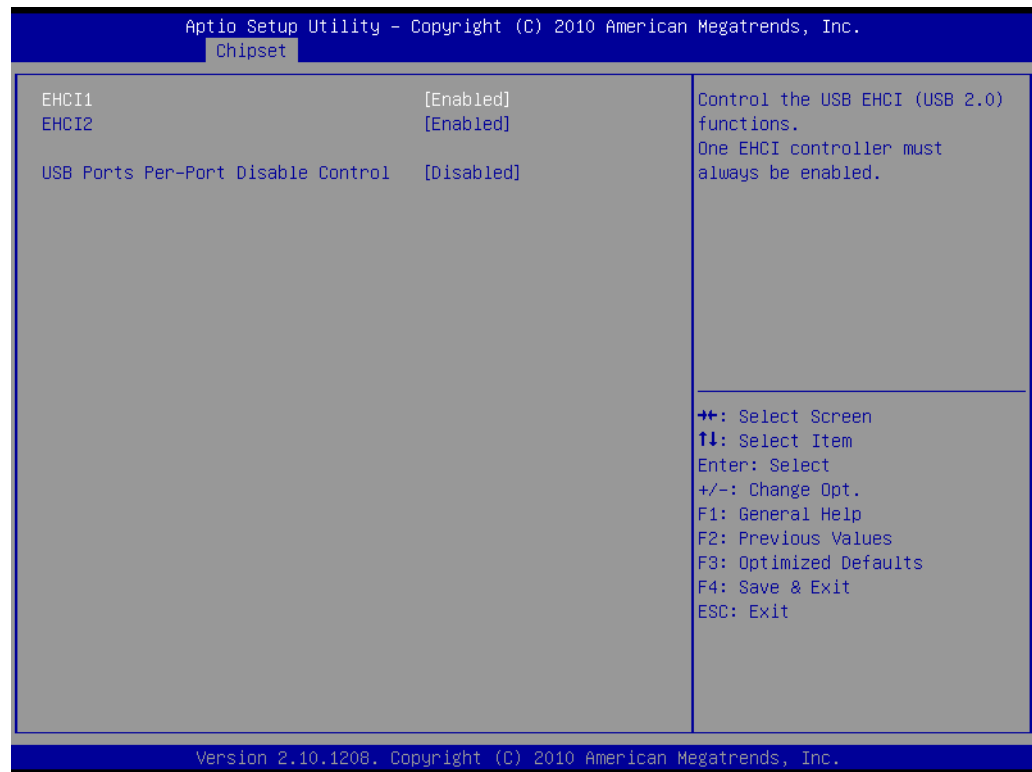

■ **USB Configuration**

Disable / Enable the USB controller (EHCI #1) and (EHCI #2) and allow users to disable/ enable USB ports.

3.5 Boot Setting

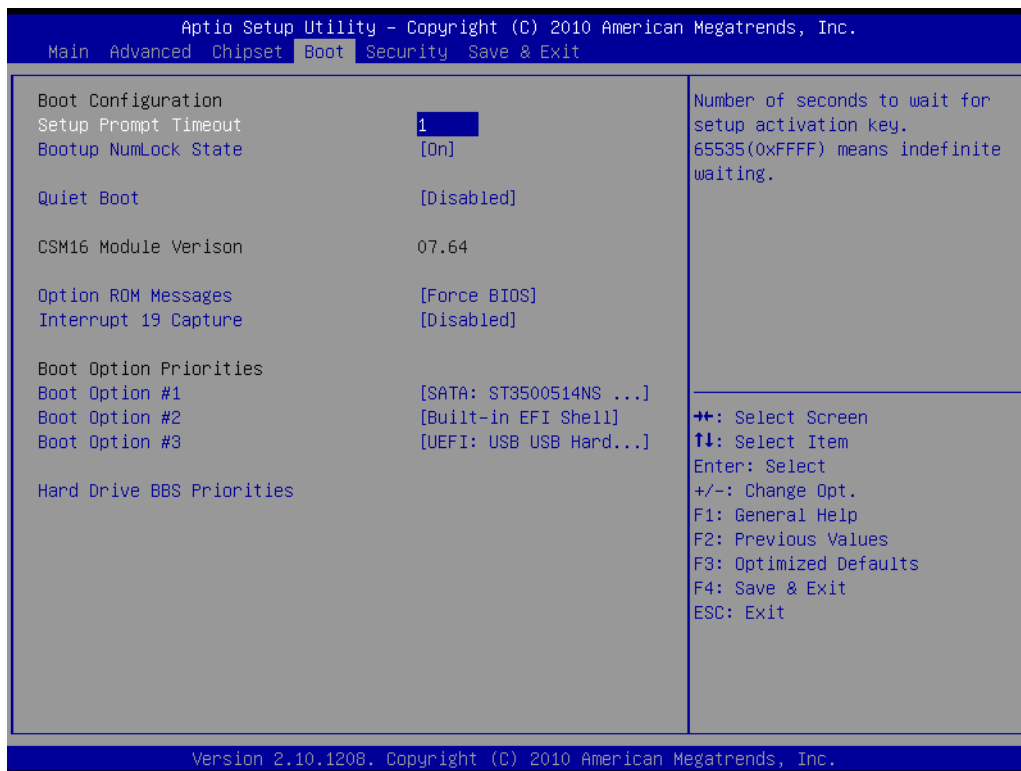

- **Quiet Boot**
If this option is set to Disabled, the BIOS displays normal POST messages. If Enabled, an OEM Logo is shown instead of POST messages.
- **Fast Boot**
This item allows BIOS to skip certain tests while booting. This will decrease the time needed to boot the system.
- **Setup Prompt Timeout**
Number of seconds to wait for setup activation key. (65535 means indefinite waiting)
- **Bootup Numlock State**
When "ON", the keyboard num lock state will stay "ON" after booting.
When "OFF", the keyboard num lock state will stay "OFF" after booting.
- **Option ROM Message**
Set display mode for option ROM
- **GateA20 Active**
UPON REQUEST: GA20 can be disabled using BIOS services.
Always: do not allow disabled GA20
- **Interrupt19 Capture:**
Enable/disable option for ROM to trap int 19.
- **Boot Option Priority**
Boot Option #1
Boot Option #2
Show the boot device choices.
- **Hard Drive BBS Priorities:**
Select the main hard disk device type to be a boot hard drive.

3.6 Security Setting



- **Administrator Password**
Select this option and press <ENTER> to access the sub menu, and then type in the password. Set the Administrator password.
- **User Password**
Select this option and press <ENTER> to access the sub menu, and then type in the password. Set the User password.

3.7 Save & Exit Configuration

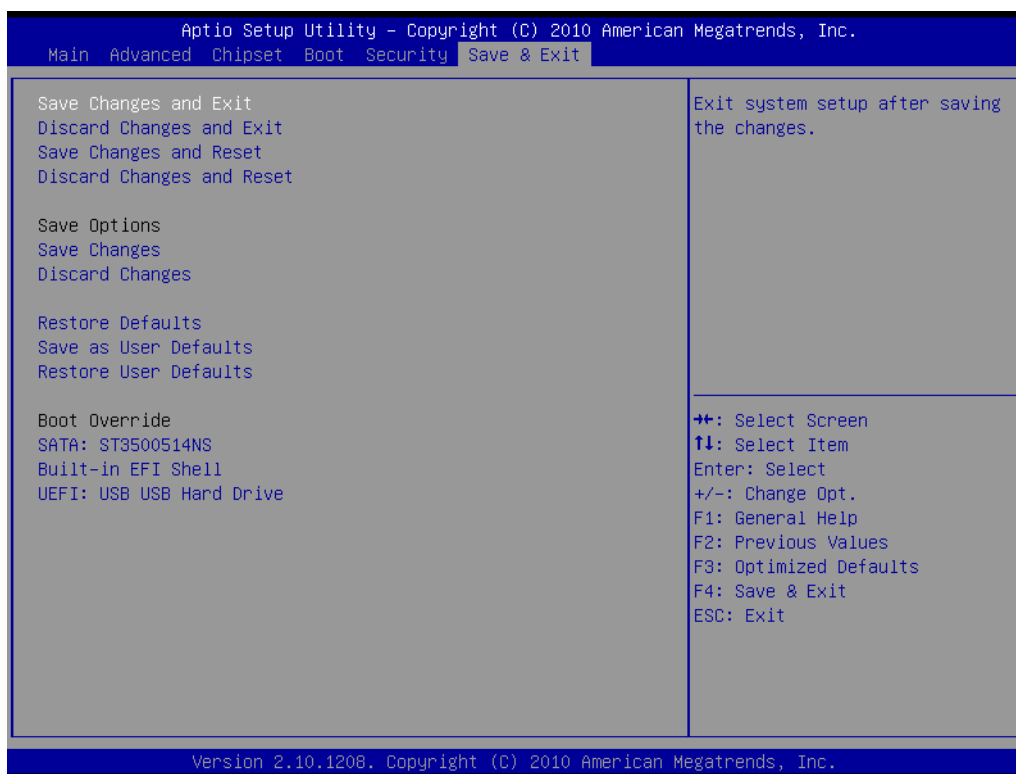

■ Save Changes and Exit

When users have completed system configuration, select this option to save changes, exit BIOS setup menu and reboot the computer to take effect all system configuration parameters.

1. Select Exit Saving Changes from the Exit menu and press <Enter>. The following message appears: Save Configuration Changes and Exit Now? [Ok] [Cancel]
2. Select Ok or cancel.

■ Discard Changes and Exit

Select this option to quit Setup without making any permanent changes to the system configuration.

1. Select Exit Discarding Changes from the Exit menu and press <Enter>. The following message appears: Discard Changes and Exit Setup Now? [Ok] [Cancel]
2. Select Ok to discard changes and exit. Discard Changes
Select Discard Changes from the Exit menu and press <Enter>.

■ Restore Default

The BIOS automatically configures all setup items to optimal settings when users select this option. Defaults are designed for maximum system performance, but may not work best for all computer applications. In particular, do not use the Defaults if the user's computer is experiencing system configuration problems. Select Restore Defaults from the Exit menu and press <Enter>.

■ Save as User Default

Save the all current settings as a user default.

■ Restore User Default

Restore all settings to user default values.

■ Boot Override

Shows the boot device types on the system.

Chapter 4

Software Introduction
& Service

4.1 Introduction

The mission of Advantech Embedded Software Services is to "Enhance quality of life with Advantech platforms and Microsoft® Windows® embedded technology." We enable Windows® Embedded software products on Advantech platforms to more effectively support the embedded computing community. Customers are freed from the hassle of dealing with multiple vendors (hardware suppliers, system integrators, embedded OS distributors) for projects. Our goal is to make Windows® Embedded Software solutions easily and widely available to the embedded computing community.

4.2 Value-Added Software Services

Software API: An interface that defines the ways by which an application program may request services from libraries and/or operating systems. Provides not only the underlying drivers required but also a rich set of user-friendly, intelligent and integrated interfaces, which speeds development, enhances security and offers add-on value for Advantech platforms. It plays the role of catalyst between developer and solution, and makes Advantech embedded platforms easier and simpler to adopt and operate with customer applications.

4.2.1 Software API

4.2.1.1 Control

GPIO



General Purpose Input/Output is a flexible parallel interface that allows a variety of custom connections. It allows users to monitor the level of signal input or set the output status to switch on/off the device. Our API also provide Programmable GPIO, which allows developers to dynamically set the GPIO input or output status.

SMBus



SMBus is the System Management Bus defined by Intel Corporation in 1995. It is used in personal computers and servers for low-speed system management communications. The SMBus API allows a developer to interface a embedded system environment and transfer serial messages using the SMBus protocols, allowing multiple simultaneous device control.

4.2.1.2 Display

Brightness Control



The Brightness Control API allows a developer to access embedded devices and easily control brightness.

Backlight



The Backlight API allows a developer to control the backlight (screen) on/off in embedded devices.

4.2.1.3 Monitor

Watchdog



A watchdog timer (WDT) is a device that performs a specific operation after a certain period of time if something goes wrong and the system does not recover on its own. A watchdog timer can be programmed to perform a warm boot (restarting the system) after a certain number of seconds.

Hardware Monitor



The Hardware Monitor (HWM) API is a system health supervision API that inspects certain condition indexes, such as fan speed, temperature and voltage.

4.2.1.4 Power Saving

CPU Speed



Makes use of Intel SpeedStep technology to save power consumption. The system will automatically adjust the CPU speed depending on the system loading.

System Throttling

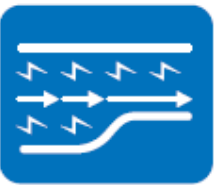

Refers to a series of methods for reducing power consumption in computers by lowering the clock frequency. This API allows the user to adjust the clock from 87.5% to 12.5%.

4.2.2 Software Utility

BIOS Flash

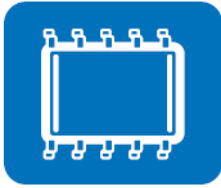

The BIOS Flash utility allows customers to update the flash ROM BIOS version, or use it to back up current BIOS by copying it from the flash chip to a file on customers' disk. The BIOS Flash utility also provides a command line version and an API for fast implementation into customized applications.

Embedded Security ID



The embedded application is the most important property of a system integrator. It contains valuable intellectual property, design knowledge and innovation, but it is easy to be copied! Embedded Security ID utility which provides reliable security functions for customers to secure their application data within embedded BIOS.

Monitoring



The Monitoring is a utility for customer to monitor the system health, like voltage, CPU and system temperature and fan speed. These items are important to a device, if the critical errors occur and are not solved immediately, permanent damage may be caused.

eSOS



The eSOS is a small OS stored in BIOS ROM. It will boot up in case of a main OS crash. It will diagnose the hardware status, and then send an e-mail to the designated administrator. The eSOS also provide for remote connection via Telnet server and FTP server so the administrator can attempt to rescue the system. Note: This function requires BIOS customization.

Chapter 5

Chipset Software
Installation Utility

5.1 Before You Begin

To facilitate the installation of the enhanced display drivers and utility software, read the instructions in this chapter carefully. The drivers for the AIMB-581 are located on the software installation CD. The driver in the folder of the driver CD will guide and link you to the utilities and drivers under a Windows system. Updates are provided via Service Packs from Microsoft*.

Note! *The files on the software installation CD are compressed. Do not attempt to install the drivers by copying the files manually. You must use the supplied SETUP program to install the drivers.*



Before you begin, it is important to note that most display drivers need to have the relevant software application already installed in the system prior to installing the enhanced display drivers. In addition, many of the installation procedures assume that you are familiar with both the relevant software applications and operating system commands. Review the relevant operating system commands and the pertinent sections of your application software's user manual before performing the installation.

5.2 Introduction

The Intel® Chipset Software Installation (CSI) utility installs the Windows INF files that outline to the operating system how the chipset components will be configured. This is needed for the proper functioning of the following features:

- Core PCI PnP services
- IDE Ultra ATA 100/66/33 and Serial ATA interface support
- USB 1.1/2.0 support (USB 2.0 driver needs to be installed separately for Win98)
- Identification of Intel® chipset components in the Device Manager

Note! *This utility is used for the following versions of Windows, and it has to be installed **before** installing all the other drivers:*



- Windows 7 (32-bit)
- Windows 7 (64-bit)
- Windows XP professional edition (32-bit)
- Windows XP professional edition (64-bit)

5.3 Windows XP/Windows 7 Driver Setup

1. Insert the driver CD into your system's CD-ROM drive. You can see the driver folder items. Navigate to the "Chipset" folder and click "infinst_autol.exe" to complete the installation of the driver.

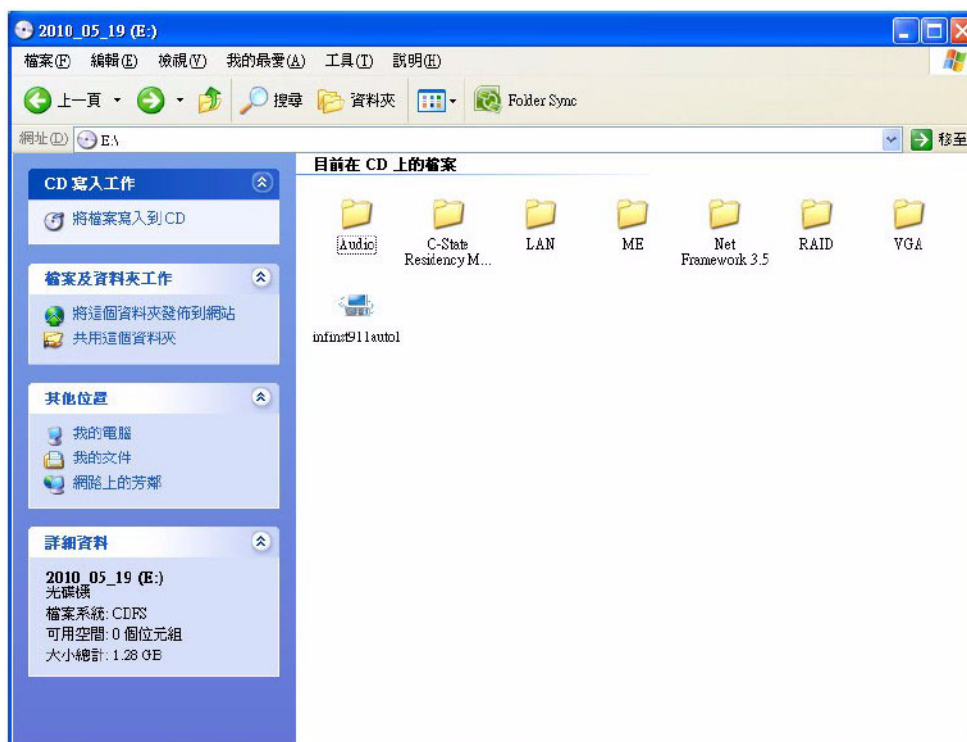

Chapter 6

VGA Setup

6.1 Introduction

The Intel mobile Core i7-2710QE, Core i5-2510E, Core i3-2330E, Celeron B810 CPUs with dual core are embedded with an integrated graphics controller. You need to install the VGA driver to enable the function.

Optimized integrated graphic solution: With Intel Graphics Flexible, it supports versatile display options and 32-bit 3D graphics engine. Dual independent display, enhanced display modes for widescreen flat panels for extend, twin, and clone dual display mode, and optimized 3D support deliver an intensive and realistic visual experience.

6.2 Windows 7/XP

Note! Before installing this driver, make sure the CSI utility has been installed in your system. See Chapter 5 for information on installing the CSI utility.



Insert the driver CD into your system's CD-ROM drive. You can see the driver folders items. Navigate to the "VGA" folder and click "setup.exe" to complete the installation of the drivers for Windows 7 and Windows XP.

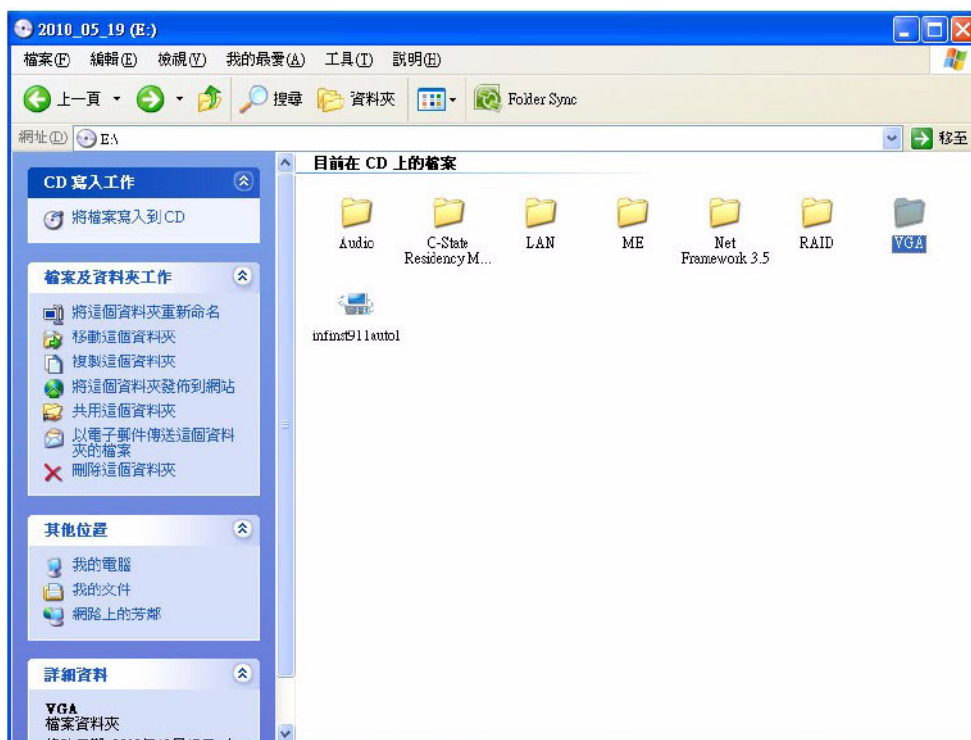

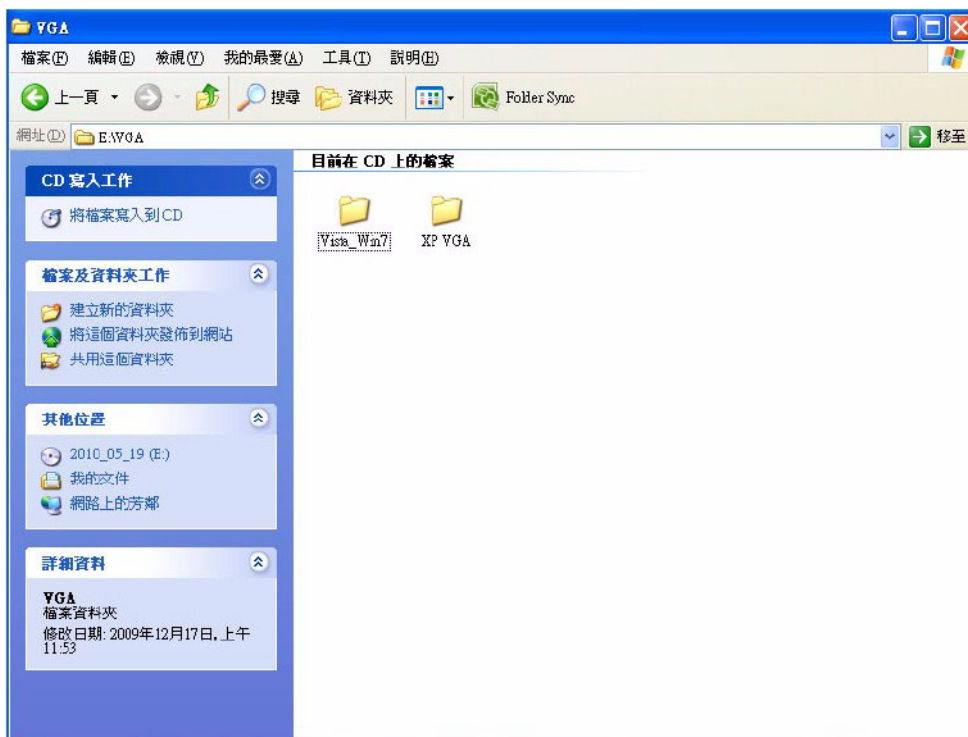

Chapter 7

LAN Configuration

7.1 Introduction

The AIMB-581 has dual Gigabit Ethernet LANs via dedicated PCI Express x1 lanes (Intel 82579LM (LAN1) and 82583V (LAN2)) that offer bandwidth of up to 500 MB/sec, eliminating the bottleneck of network data flow and incorporating Gigabit Ethernet at 1000 Mbps.

7.2 Features

- Integrated 10/100/1000 Mbps transceiver
- 10/100/1000 Mbps triple-speed MAC
- High-speed RISC core with 24-KB cache
- On-chip voltage regulation
- Wake-on-LAN (WOL) support
- PCI Express X1 host interface

7.3 Installation

Note! *Before installing the LAN drivers, make sure the CSI utility has been installed on your system. See Chapter 5 for information on installing the CSI utility.*



The AIMB-581's Intel 82579LM (LAN1) and 82583V (LAN2) Gigabit integrated controllers support all major network operating systems. However, the installation procedure varies from system to system. Please find and use the section that provides the driver setup procedure for the operating system you are using.

7.4 Windows® 7/XP Driver Setup (Intel 82579LM/82583V)

Insert the driver CD into your system's CD-ROM drive. Select the LAN folder then navigate to the directory for your OS.

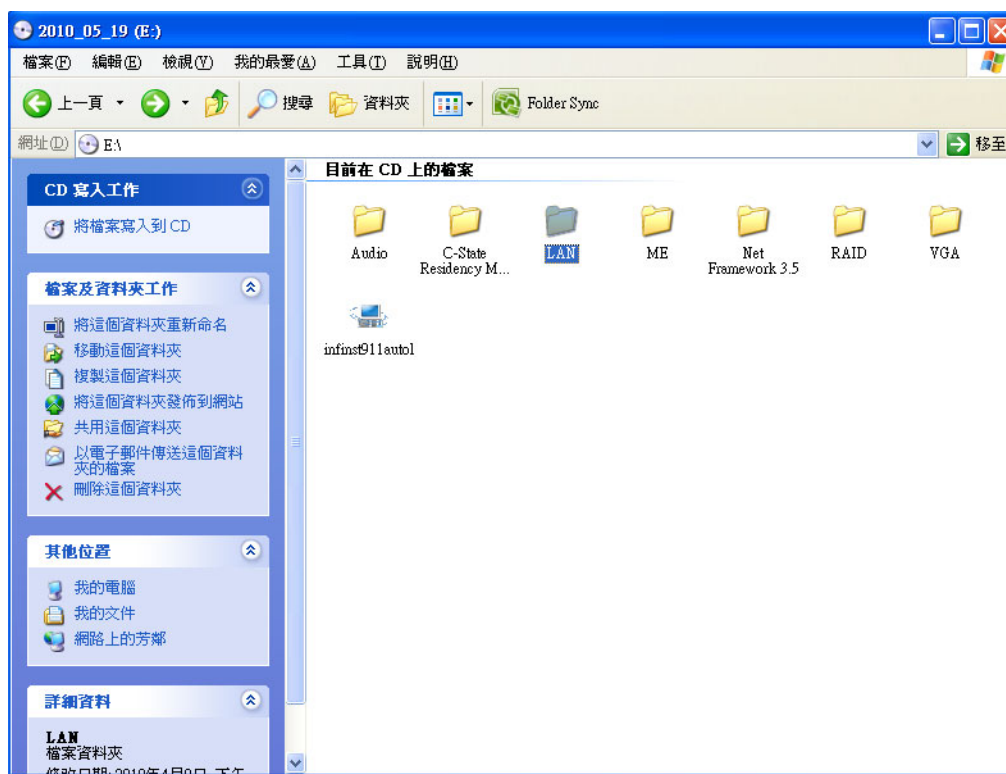

Appendix **A**

Programming the
Watchdog Timer

A.1 Programming the Watchdog Timer

The AIMB-581's watchdog timer can be used to monitor system software operation and take corrective action if the software fails to function within the programmed period. This section describes the operation of the watchdog timer and how to program it.

A.1.1 Watchdog Timer Overview

The watchdog timer is built into the super I/O controller Nuvoton NCT6776F. It provides the following user-programmable functions:

- Can be enabled and disabled by user program
- Timer can be set from 1 to 255 seconds or 1 to 255 minutes
- Generates an interrupt or resets signal if the software fails to reset the timer before time-out

A.1.2 Programming the Watchdog Timer

The I/O port address of the watchdog timer is 2E (hex) and 2F (hex). 2E (hex) is the address port. 2F (hex) is the data port. You must first assign the address of register by writing an address value into address port 2E (hex), then write/read data to/from the assigned register through data port 2F (hex).

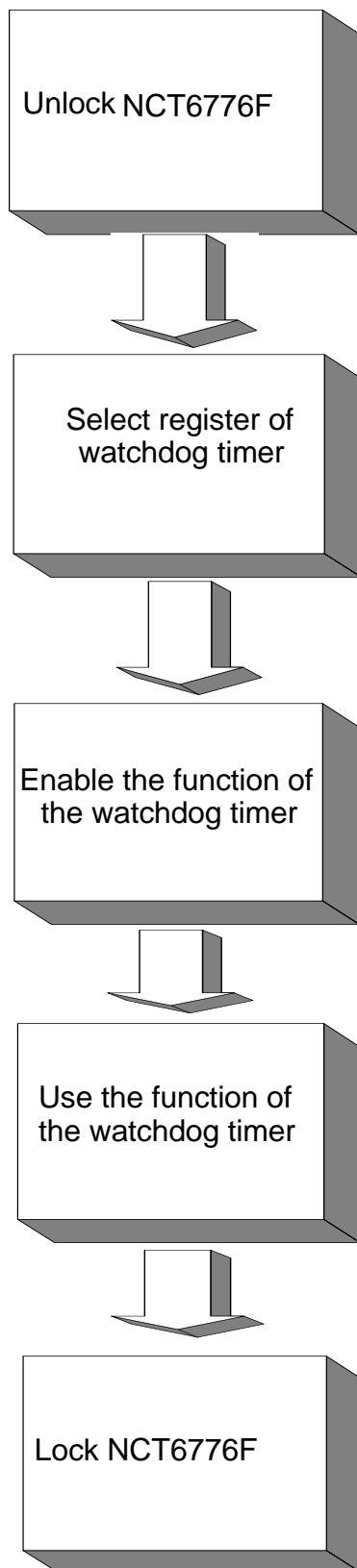

Table A.1: Watchdog Timer Registers

Address of Register (2E)	Attribute	Value (2F) & description
87 (hex)	-----	Write this address to I/O address port 2E (hex) twice to unlock the NCT6776F.
07 (hex)	write	Write 08 (hex) to select register of watchdog timer.
30 (hex)	write	Write 01 (hex) to enable the function of the watchdog timer. Disabled is set as default.
F5 (hex)	write	Set seconds or minutes as units for the timer. Write 0 to bit 3: set second as counting unit. [default] Write 1 to bit 3: set minutes as counting unit.
F6 (hex)	write	0: stop timer [default] 01~FF (hex): The amount of the count, in seconds or minutes, depends on the value set in register F5 (hex). This number decides how long the watchdog timer waits for strobe before generating an interrupt or reset signal. Writing a new value to this register can reset the timer to count with the new value.
F7 (hex)	read/write	Bit 7: Write 1 to enable mouse to reset the timer, 0 to disable [default]. Bit 6: Write 1 to enable keyboard to reset the timer, 0 to disable. [default] Bit 5: Write 1 to generate a timeout signal immediately and automatically return to 0. [default=0] Bit 4: Read status of watchdog timer, 1 means timer is "timeout".
AA (hex)	-----	Write this address to I/O port 2E (hex) to lock the watchdog timer 2.

A.1.3 Example Program

1. Enable watchdog timer and set 10 sec. as timeout interval

```

;-----
Mov dx,2eh ; Unlock NCT6776F
Mov al,87h
Out dx,al
Out dx,al
;-----
Mov al,07h ; Select registers of watchdog timer
Out dx,al
Inc dx
Mov al,08h
Out dx,al
;-----
Dec dx ; Enable the function of watchdog timer
Mov al,30h
Out dx,al
Inc dx
Mov al,01h
Out dx,al
;-----
Dec dx ; Set second as counting unit
Mov al,0f5h
Out dx,al
Inc dx
In al,dx
And al,not 08h
Out dx,al
;-----
Dec dx ; Set timeout interval as 10 seconds and start counting
Mov al,0f6h
Out dx,al
Inc dx
Mov al,10
Out dx,al
;-----
Dec dx ; Lock NCT6776F
Mov al,0aah
Out dx,al

```

2. Enable watchdog timer and set 5 minutes as timeout interval

```

;-----
Mov dx,2eh ; Unlock NCT6776F
Mov al,87h
Out dx,al
Out dx,al

```

```

;-----
Mov al,07h ; Select registers of watchdog timer
Out dx,al
Inc dx
Mov al,08h
Out dx,al
;-----
Dec dx ; Enable the function of watchdog timer
Mov al,30h
Out dx,al
Inc dx
Mov al,01h
Out dx,al
;-----
Dec dx ; Set minute as counting unit
Mov al,0f5h
Out dx,al
Inc dx
In al,dx
Or al,08h
Out dx,al
;-----
Dec dx ; Set timeout interval as 5 minutes and start counting
Mov al,0f6h
Out dx,al
Inc dx
Mov al,5
Out dx,al
;-----
Dec dx ; Lock NCT6776F
Mov al,0aah
Out dx,al
3. Enable watchdog timer to be reset by mouse
;-----
Mov dx,2eh ; Unlock NCT6776F
Mov al,87h
Out dx,al
Out dx,al
;-----
Mov al,07h ; Select registers of watchdog timer
Out dx,al
Inc dx
Mov al,08h
Out dx,al
;-----

```



```

Dec dx ; Enable the function of watchdog timer
Mov al,30h
Out dx,al
Inc dx
Mov al,01h
Out dx,al
;-----
Dec dx ; Enable watchdog timer to be reset by mouse
Mov al,0f7h
Out dx,al
Inc dx
In al,dx
Or al,80h
Out dx,al
;-----
Dec dx ; Lock NCT6776F
Mov al,0aah
Out dx,al
4. Enable watchdog timer to be reset by keyboard
;-----
Mov dx,2eh ; Unlock NCT6776F
Mov al,87h
Out dx,al
Out dx,al
;-----
Mov al,07h ; Select registers of watchdog timer
Out dx,al
Inc dx
Mov al,08h
Out dx,al
;-----
Dec dx ; Enable the function of watchdog timer
Mov al,30h
Out dx,al
Inc dx
Mov al,01h
Out dx,al
;-----
Dec dx ; Enable watchdog timer to be strobed reset by keyboard
Mov al,0f7h
Out dx,al
Inc dx
In al,dx
Or al,40h
Out dx,al

```

```

;-----
Dec dx ; Lock NCT6776F
Mov al,0aah
Out dx,al
5. Generate a time-out signal without timer counting
;-----
Mov dx,2eh ; Unlock NCT6776F
Mov al,87h
Out dx,al
Out dx,al
;-----
Mov al,07h ; Select registers of watchdog timer
Out dx,al
Inc dx
Mov al,08h
Out dx,al
;-----
Dec dx ; Enable the function of watchdog timer
Mov al,30h
Out dx,al
Inc dx
Mov al,01h
Out dx,al
;-----
Dec dx ; Generate a time-out signal
Mov al,0f7h
Out dx,al ;Write 1 to bit 5 of F7 register
Inc dx
In al,dx
Or al,20h
Out dx,al
;-----
Dec dx ; Lock NCT6776F
Mov al,0aah
Out dx,al

```

Appendix **B**

I/O Pin Assignments

B.1 USB Header (USB56, USB78,USB9010,USB1112)

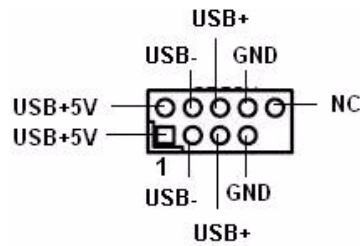

Table B.1: USB Header (USB56)

Pin	Signal	Pin	Signal
1	USB0_VCC5	2	USB1_VCC5
3	USB0_D-	4	USB1_D-
5	USB0_D+	6	USB1_D+
7	GND	8	GND
9	Key	10	GND

B.2 VGA Connector (VGA1)

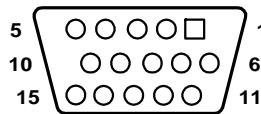

Table B.2: VGA Connector (VGA1)

Pin	Signal	Pin	Signal
1	RED	9	CRT_VCCIN
2	VGA_G	10	GND
3	VGA_B	11	N/C
4	N/C	12	V_SDAT
5	GND	13	H-SYNC
6	GND	14	V-SYNC
7	GND	15	V_SCLK

B.3 DVI1:DVI connector

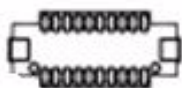

Table B.3: DVI1:DVI connector

Pin	Signal	Pin	Signal
1	TDC-0	2	+V5
3	TDC+0-	4	TLC-
5	GND	6	TLC+
7	TDC-1	8	GND
9	TDC+1	10	SC_DDC
11	GND	12	SD_DDC
13	TDC-2	14	HPDETT
15	TDC+2	16	NC
17	+V5	18	NC
19	NC	20	NC

B.4 SPI_CN1: SPI Fresh Card Pin Connector

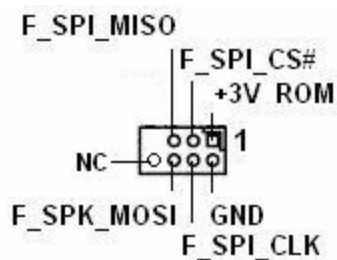

Table B.4: SPI_CN1:SPI Fresh Card Pin Connector

Pin	Signal	Pin	Signal
1	+F1_3V	2	GND
3	F1_SPI_CS#_Q	4	F1_SPI_CLK_Q
5	F1_SPI_MISO_Q	6	F1_SPI_MOSI_Q
7	NC	8	NC

B.5 PS/2 Keyboard and Mouse Connector (KBMS1)



Table B.5: PS/2 Keyboard and Mouse Connector (KBMS1)

Pin	Signal
1	KB DATA
2	N/C
3	GND
4	KB VCC
5	KB CLK
6	N/C
7	M_DATA
8	N/C
9	GND
10	M_VCC
11	M_CLK
12	N/C

B.6 RS-232 Interface (COM3/4/5/6)

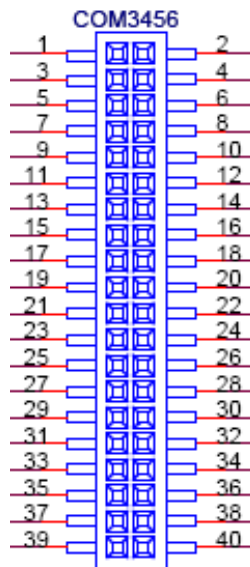
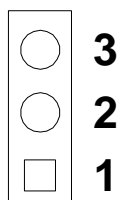

Table B.6: RS-232 Interface (COM4~COM6)

Pin	Signal	Pin	Signal
1	DCD_3	2	DSR_3
3	RXD_3	4	RTS_3
5	TXD_3	6	CTS_3
7	DTR_3	8	RRI_3
9	GND_3	10	GND_3
11	DCD_4	12	DSR_4
13	RXD_4	14	RTS_4
15	TXD_4	16	CTS_4
17	DTR_4	18	RRI_4
19	GND_4	20	GND_4
21	DCD_5	22	DSR_5
23	RXD_5	24	RTS_5
25	TXD_5	26	CTS_5
27	DTR_5	28	RRI_5
29	GND_5	30	GND_5
31	DCD_6	32	DSR_6
33	RXD_6	34	RTS_6
35	TXD_6	36	CTS_6
37	DTR_6	38	RRI_6
39	GND_6	40	GND_6

B.7 CPU Fan Power Connector (CPU_FAN1)

**Table B.7: CPU Fan Power Connector (CPU_FAN1)**

Pin	Signal
1	GND
2	+12V PWM
3	DETECT

B.8 System Fan Power Connector (SYS_FAN1/2/3/4)

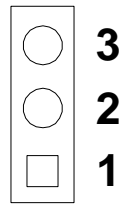

Table B.8: System Fan Power Connector (SYSFAN1/SYSFAN2/SYSFAN3/SYSFAN4)

Pin	Signal
1	GND
2	+12V PWM
3	DETECT

B.9 Power LED & Keyboard Lock Connector (JFP2)

You can use an LED to indicate when the single board computer is on. Pin 1 of JFP3 supplies the LED's power, and Pin 3 is the ground.

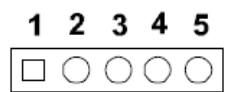

Table B.9: Power LED & Keyboard Lock Connector (JFP2)

Pin	Function
1	LED power
2	NC
3	GND
4	KEYLOCK#
5	GND

B.10 Power switch/HDD LED/SMBus/Speaker (JFP1)

The single board computer has its own buzzer. You can also connect it to the external speaker on your computer chassis.

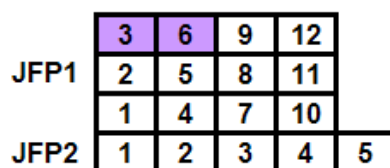

Table B.10: Power Switch/HDD LED/SMBus/Speaker (JFP1)

Pin	Signal	Pin	Signal
1	SPK_P1	2	HDDLED+
3	PWR	4	NC
5	HDDLED-	6	GND
7	SPK_P3	8	SMB_DAT
9	SYS_RST	10	SPK_P4
11	SMB_CLK	12	GND

B.11 USB/LAN ports (LAN1_USB12/LAN2_USB34)

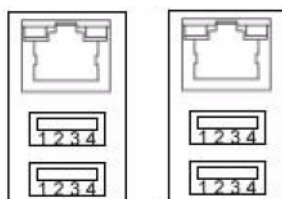

Table B.11: USB Port

Pin	Signal	Pin	Signal
1	VCC	3	Data0+
2	Data0-	4	GND

Table B.12: Ethernet 10/100 Mbps RJ-45 Port

Pin	Signal	Pin	Signal
1	XMT+	5	N/C
2	XMT-	6	RCV-
3	RCV+	7	N/C
4	N/C	8	N/C

B.12 Line In, Line Out, Mic In Connector (AUDIO1)

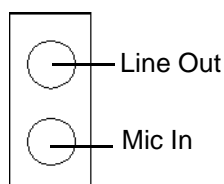

B.13 Serial ATA0/1 (SATA1 ~ 6)

Table B.13: Serial ATA 0/1 (SATA1 ~ 6)

Pin	Signal	Pin	Signal
1	GND	2	SATA_0TX+
3	SATA_0TX-	4	GND
5	SATA_0RX-	6	SATA_0RX+
7	GND	8	

B.14 AT/ATX Mode (PSON1)

Table B.14: AT/ATX Mode (PSON1)

Pin	Signal	Pin	Signal
1	#PSON_SIO (to super IO)	2	#PSON (to power supply)
3	GND		

B.15 HD Audio Interface (FPAUD1)

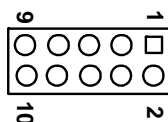

Table B.15: AC-97 Audio Interface (FPAUD1)

Pin	Signal	Pin	Signal
1	MIC2_L	2	GND
3	MIC2_R	4	FP_AUD_DET
5	LOUT2_R	6	SRTN1
7	LOUT2_DET	8	KEY
9	LOUT2_L	10	SRTN2

B.16 GPIO Pin Header (GPIO1)

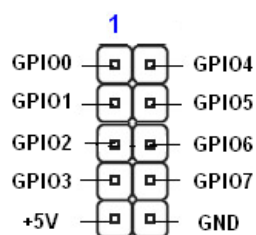

Table B.16: GPIO Pin Header (GPIO1)

Pin	Signal	Pin	Signal
1	GPIO0	2	GPIO4
3	GPIO1	4	GPIO5
5	GPIO2	6	GPIO6
7	GPIO3	8	GPIO7
9	+5V	10	GND

B.17 LVDS Connector: LVDS1

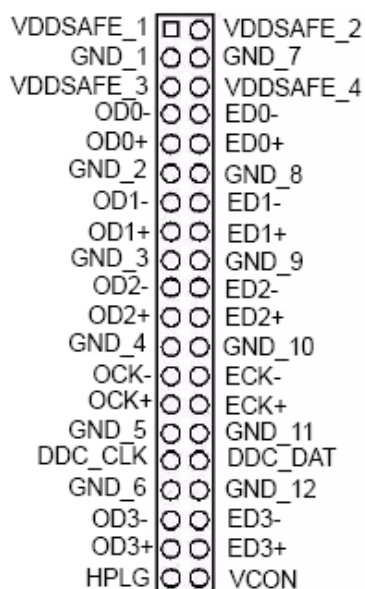

Table B.17: LVDS1 Connector

Pin	Signal	Pin	Signal
1	VDDSAFE_1	2	VDDSAFE_2
3	GND_1	4	GND_7
5	VDDSAFE_3	6	VDDSAFE_4
7	OD0-	8	ED0-
9	OD0+	10	ED0+
11	GND_2	12	GND_8
13	OD1-	14	ED1-
15	OD1+	16	ED1+

Table B.17: LVDS1 Connector

17	GND_3	18	GND_9
19	OD2-	20	ED2-
21	OD2+	22	ED2+
23	GND_4	24	GND_10
25	OCK-	26	ECK-
27	OCK+	28	ECK+
29	GND_3	30	GND_11
31	DDC_CLK	32	DDC_DAT
33	GND_6	34	GND_12
35	OD3-	36	ED3-
37	OD3+	38	ED3+
39	HPLG	40	VCON

B.18 LVDS Power Jumper (JLVDS1)

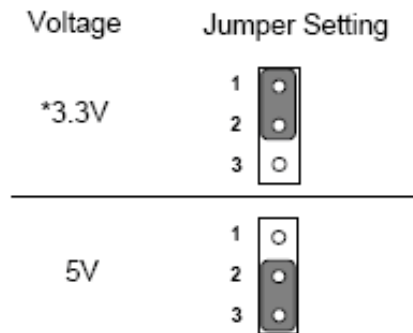

* default setting

Table B.18: LVDS Power Jumper

Pin	Signal
1	VCC3
2	VCC_LCD
3	VCC

B.19 LVDS Inverter (INV1)

Table B.19: LVDS Power Jumper

Pin	Signal
1	+12V
2	GND
3	BL_EN
4	BL_CLT
5	+5V

B.20 ATX Power Connector (ATXPWR1)

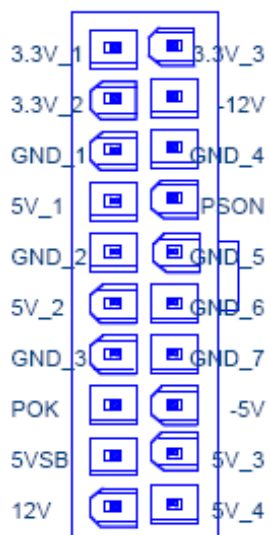

Table B.20: ATX Power Connector (ATXPWR1)

Pin	Signal	Pin	Signal
1	+3.3 V	11	3.3 V
2	+3.3 V	12	-12 V
3	GND	13	GND
4	+5 V	14	PSON
5	GND	15	GND
6	+5 V	16	GND
7	GND	17	GND
8	POK	18	-5 V
9	5 VSB	19	+5 V
10	12 V	20	+5 V

B.21 ATX 12 V connector (ATX12V1)

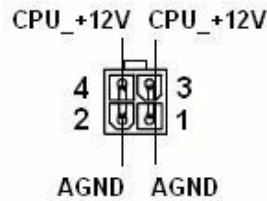

Table B.21: ATX 12 V connector (ATX12V1)

Pin	Signal	Pin	Signal
1	aGND	2	aGND
3	CPU_+12V	4	CPU_+12V

B.22 DMA Channel Assignments

Table B.22: DMA Channel Assignments

Channel	Function
0	Available
1	Available
2	Floppy disk (8-bit transfer)
3	Available
4	Cascade for DMA controller 1
5	Available
6	Available
7	Available

B.23 Interrupt Assignments

Table B.23: Interrupt Assignments

Priority	Interrupt#	Interrupt source
1	NMI	Parity error detected
2	IRQ0	Interval timer
3	IRQ1	Keyboard
-	IRQ2	Interrupt from controller 2 (cascade)
4	IRQ8	Real-time clock
5	IRQ9	Cascaded to INT 0A (IRQ 2)
6	IRQ10	Serial communication port 4/6
7	IRQ11	Serial communication port 3/5
8	IRQ12	PS/2 mouse
9	IRQ13	INT from co-processor
10	IRQ14	Primary IDE Channel
11	IRQ15	Secondary IDE Channel
12	IRQ3	Serial communication port 2
13	IRQ4	Serial communication port 1
14	IRQ5	Available
15	IRQ6	Available
16	IRQ7	Parallel port 1 (print port)

B.24 1st MB Memory Map

Table B.24: 1st MB Memory Map

Addr. range (Hex)	Device
E0000h - FFFFFh	BIOS
CC000h - DFFFFh	Unused
C0000h - CBFFFh	VGA BIOS
A0000h - BFFFFh	Video Memory
00000h - 9FFFFh	Base memory