

1. SPECIFICATION

AK-M36M8-3C

ITEM		SPECIFICATIONS	
01	Type	Dynamic speaker	
02	Dimension	External diameter 36 mm	
03	Rated Input Power	0.5 W	
04	Max. Input Power	1.0 W for 1 Minute.	
05	Impedance	8 ohm \pm 15% at 1K Hz	
06	Resonance Frequency (Fo)	550 Hz \pm 20% at Fo, 1V	
07	Sensitivity (S.P.L.)	88dB(0.1W/0.1m) \pm 3 dB	at AVE 0.8,1.0,1.2,1.5 KHz.
		94 dB(0.5W/0.1m) \pm 3 dB	
08	Frequency Range	Fo – 6K Hz	
09	Total Harmonics Distortion	Max 5 % at 1 KHz,0.1W.	

REV NO.	REVISION NOTE	APPROVAL	DATE
---------	---------------	----------	------

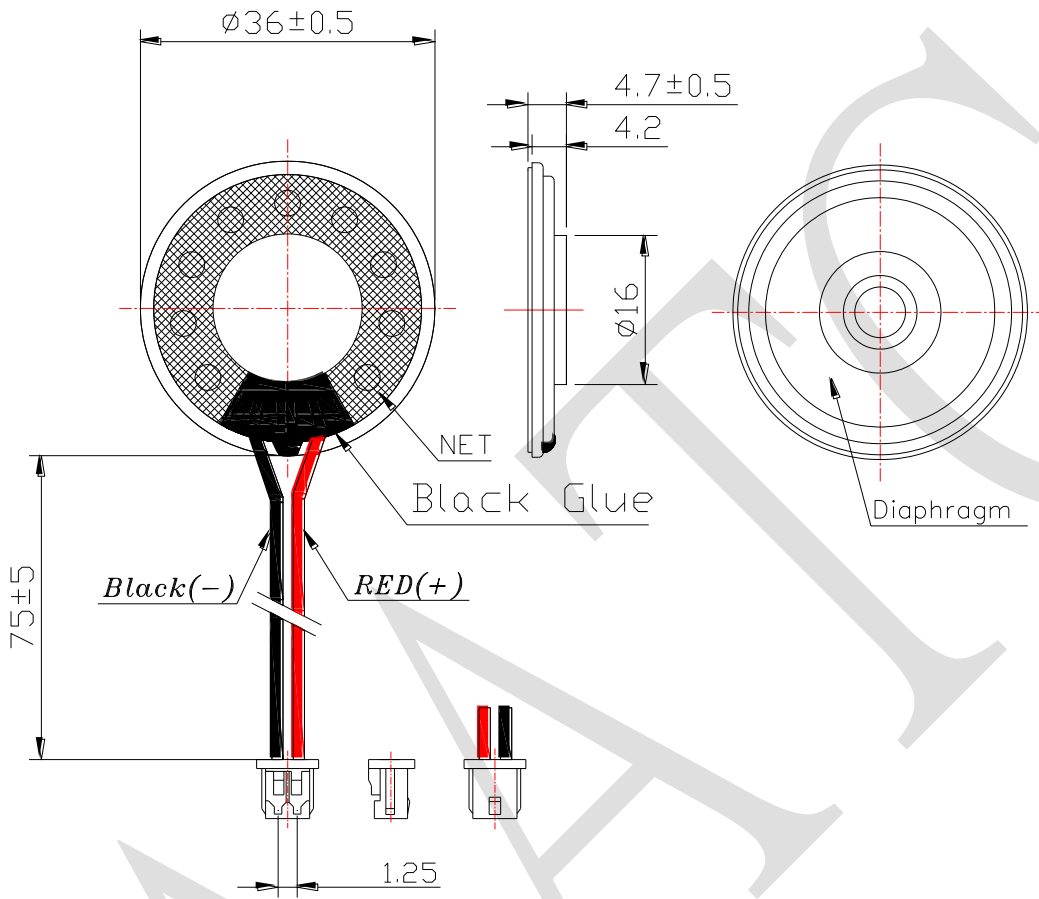

Wire: UL1571,AWG28#
Connector:Equivalent to Molex 51021-0200

RoHS

TITLE: DYNAMIC SPEAKER		DRAWN: Moose	2015/08/07	SCALE: 2:1	SHEET: 1:1
PART NO. AK-M36M8-3C		DESIGNED: R&D OF AAT	UNITS: mm		
DWG NO. CXS36047LP75-R08W0.5-B1	2 REV	CHECKED:	TOLERANCE ± 0.5		
		APPROVAL:	UNLESS OTHERWISE SPECIFIED		
		MATERIAL: SPCC	ONE PLACE DECIMAL \pm ***		
				TWO PLACE DECIMAL \pm ***	
				THREE PLACE DECIMAL \pm ***	



ADVANCED ACOUSTIC TECHNOLOGY CORPORATION