

Description

The DIODES™ AL8843 is a hysteresis mode DC-DC step-down converter, designed for driving single or multiple series connected LEDs efficiently from a voltage source higher than the LED voltage. The device can operate from an input supply between 4.5V and 40V and provide an externally adjustable output current up to 3A. Depending upon supply voltage and external components, this converter can provide up to 60W of output power.

The AL8843 integrates the power switch and a high-side output current sensing circuit, which uses an external resistor to set the nominal average output current.

Dimming can be realized by applying an external control signal to the CTRL pin. The CTRL pin will accept either a DC voltage signal or a PWM signal.

The soft-start time can be adjusted by an external capacitor from the CTRL pin to Ground. Applying a voltage of 0.3V or lower to the CTRL pin will shut down the power switch.

Features

- Wide Input Voltage Range: 4.5V to 40V
- Output Current up to 3A
- Internal 40V NDMOS Switch
- Typical 4% Output Current Accuracy
- Single Pin for On/Off and Brightness Control by DC Voltage or PWM Signal
- Recommended Analog Dimming Range: 10% to 100%
- Soft-Start
- High Efficiency (Up to 97%)
- LED Short Protection
- Inherent Open-Circuit LED Protection
- Over Temperature Protection (OTP)
- Up to 1MHz Switching Frequency
- SO-8EP Package Available in Green Molding Compound (No Br, Sb)
- **Totally Lead-Free & Fully RoHS Compliant (Notes 1 & 2)**
- **Halogen and Antimony Free. "Green" Device (Note 3)**
- **An Automotive-Compliant Part is Available Under Separate Datasheet ([AL8843Q](#))**

- Notes:
1. No purposely added lead. Fully EU Directive 2002/95/EC (RoHS), 2011/65/EU (RoHS 2) & 2015/863/EU (RoHS 3) compliant.
 2. See <https://www.diodes.com/quality/lead-free/> for more information about Diodes Incorporated's definitions of Halogen- and Antimony-free, "Green" and Lead-free.
 3. Halogen- and Antimony-free "Green" products are defined as those which contain <900ppm bromine, <900ppm chlorine (<1500ppm total Br + Cl) and <1000ppm antimony compounds.

Pin Assignments

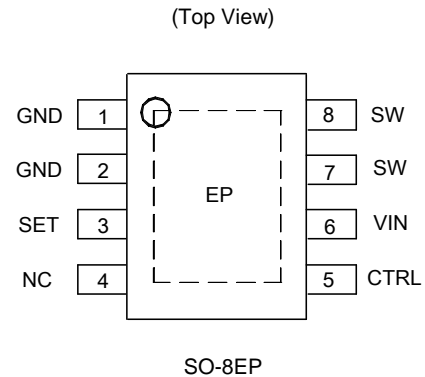

Applications

- LED retrofit for low voltage halogen
- Low voltage industrial lighting
- LED backlighting
- Illuminated signs
- External drivers with multiple channels

Typical Applications Circuit

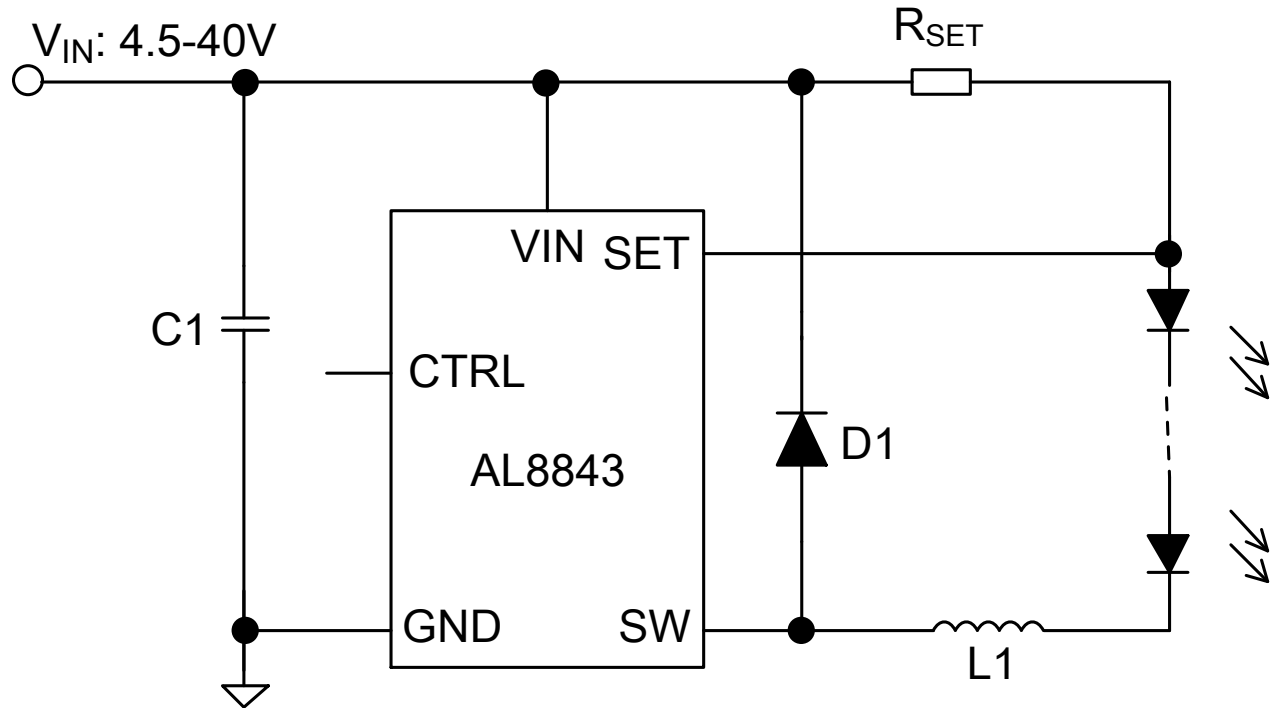

Pin Descriptions

Pin Number	Pin Name	Function
1, 2	GND	Ground of IC
3	SET	Set nominal output current pin. Connect resistor R_{SET} from this pin to VIN to define nominal average output current.
4	NC	No connection
5	CTRL	Multi-function On/Off and brightness control pin: <ul style="list-style-type: none"> • Leave floating for normal operation. • Drive to voltage below 0.3V to turn off output current. • Drive with DC voltage ($0.4V < CTRL < 2.5V$) to adjust output current from 10% to 100% of I_{OUT_NOM}. • Drive with an analog voltage $> 2.6V$ output current will be 100% of I_{OUT_NOM}. • A PWM signal (Low level $< 0.3V$, High level $> 2.6V$, transition times less than $1\mu s$) allows the output current to be adjusted over a wide range up to 100%. • Connect a capacitor from this pin to ground to increase soft-start time. (Default soft-start time = 0.1ms. Additional soft-start time is approx. $1.5ms/1nF$)
6	VIN	Input voltage (4.5V to 40V). Decouple to ground with $10\mu F$ or higher X7R ceramic capacitor close to device.
7, 8	SW	Switch pin. Connect inductor/freewheeling diode here, minimizing track length at this pin to reduce EMI.
EP	EP	Exposed pad/TAB connects to GND and thermal mass for enhanced thermal impedance.

Functional Block Diagram

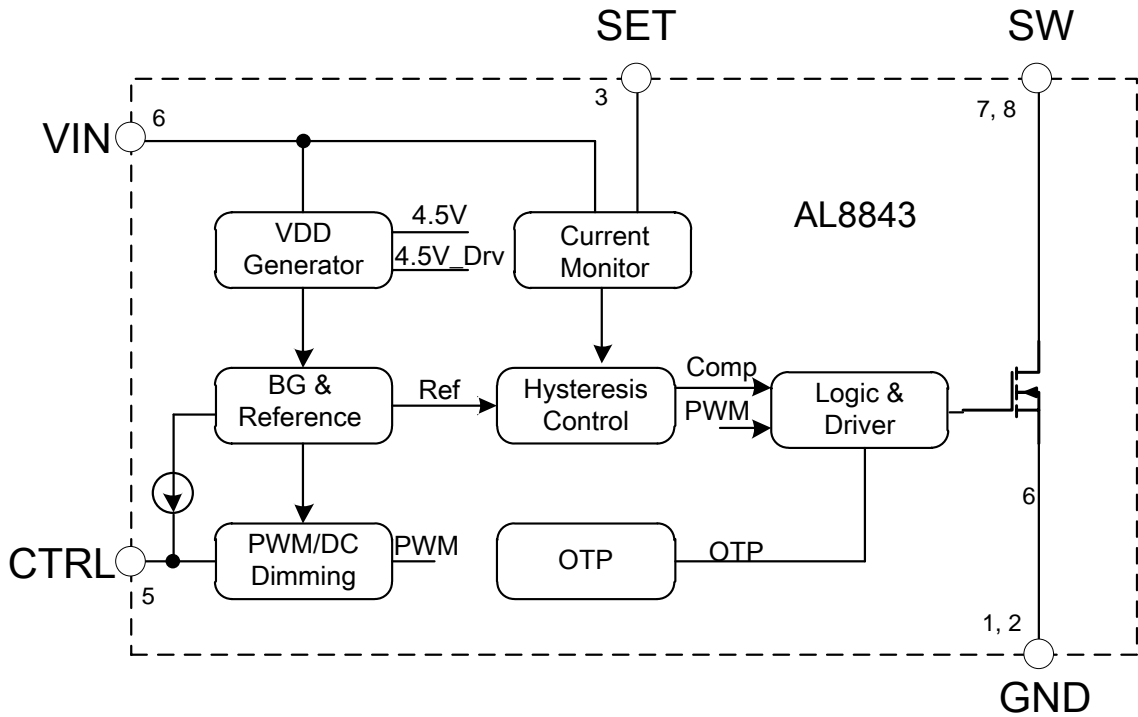

Absolute Maximum Ratings (Note 4)

Symbol	Parameter	Rating	Unit
V_{IN}	Input Voltage	-0.3 to +42	V
V_{SW}, V_{SET}	SW, SET Pin Voltage	-0.3 to +42	V
V_{CTRL}	CTRL Pin Input Voltage	-0.3 to +6	V
T_J	Operating Junction Temperature	-40 to +150	°C
T_{STG}	Storage Temperature Range	-65 to +150	°C
T_{LEAD}	Lead Temperature (Soldering, 10s)	+300	°C

Note: 4. Stresses greater than those listed under *Absolute Maximum Ratings* can cause permanent damage to the device. These are stress ratings only, and functional operation of the device at these or any other conditions beyond those indicated under *Recommended Operating Conditions* is not implied. Exposure to *Absolute Maximum Ratings* for extended periods can affect device reliability.

ESD Ratings

Symbol	Parameter	Rating	Unit
V_{ESD}	Human-Body Model (HBM)	-2500 to 2500	V
	Machine Model (MM)	-200 to 200	

Recommended Operating Conditions

Symbol	Parameter	Min	Max	Unit
V _{IN}	Input Voltage	4.5	40	V
f _{SW}	Switching Frequency	—	1	MHz
I _{OUT}	Continuous Output Current	—	3	A
V _{CTRL}	Voltage Range for 10% to 100% DC Dimming Relative to GND	0.4	2.5	V
V _{CTRL_HIGH}	Voltage High for PWM Dimming Relative to GND	2.6	5	V
V _{CTRL_LOW}	Voltage Low for PWM Dimming Relative to GND	0	0.3	V
T _A	Operating Ambient Temperature	-40	+105	°C
T _J	Operating Junction Temperature	-40	+125	°C

Thermal Information (Note 5)

Symbol	Parameter	Rating	Unit
θ _{JA}	Junction-to-Ambient Thermal Resistance	56	°C/W
θ _{JC}	Junction-to-Case (Top) Thermal Resistance	11	°C/W

Note: 5. Device mounted on 2" x 2" FR-4 substrate PCB, 2oz copper, with minimum recommended pad layout.

Electrical Characteristics (@V_{IN} = 16V, T_A = +25°C, unless otherwise specified.)

Symbol	Parameter	Condition	Min	Typ	Max	Unit
SUPPLY VOLTAGE						
V _{IN}	Input Voltage	—	4.5	—	40	V
I _Q	Quiescent Current	CTRL Pin Floating, V _{IN} = 16V	—	0.35	—	mA
V _{UVLO}	Under Voltage Lockout	V _{IN} Rising	—	3.9	—	V
V _{UVLO_HYS}	UVLO Hysteresis	—	—	250	—	mV
HYSTERESTIC CONTROL						
V _{SET}	Mean Current Sense Threshold Voltage	Measured on SET Pin with Respect to V _{IN}	96	100	104	mV
V _{SET_HYS}	Sense Threshold Hysteresis	—	—	±13	—	%
I _{SET}	SET Pin Input Current	V _{SET} = V _{IN} - 0.1V	—	8	—	µA
ENABLE AND DIMMING						
V _{CTRL}	Voltage Range on CTRL Pin	For Analog Dimming	0.4	—	2.5	V
—	Analog Dimming Range	—	10	—	100	%
V _{CTRL_ON}	DC Voltage on CTRL Pin for Analog Dimming On	V _{CTRL} Rising	—	0.45	—	V
V _{CTRL_OFF}	DC Voltage on CTRL Pin for Analog Dimming Off	V _{CTRL} Falling	—	0.40	—	V
SWITCHING OPERATION						
R _{ON}	SW Switch On Resistance	@I _{SW} = 100mA	—	0.2	—	Ω
I _{SW_LEAK}	SW Switch Leakage Current	—	—	—	8	µA
t _{SS}	Soft Start Time	V _{IN} = 16V, C _{CTRL} = 1nF	—	1.5	—	ms
f _{SW}	Operating Frequency	V _{IN} = 16V, V _O = 9.6V (3 LEDs) L = 47µH, ΔI = 0.25A (I _{LED} = 1A)	—	250	—	kHz
f _{SW_MAX}	Recommended Maximum Switch Frequency	—	—	—	1	MHz
t _{ON_REC}	Recommended Minimum Switch ON Time	For 4% Accuracy	—	500	—	ns
t _{PD}	Internal Comparator Propagation Delay (Note 6)	—	—	100	—	ns
THERMAL SHUTDOWN						
T _{OTP}	Over Temperature Protection	—	—	+150	—	°C
T _{OTP_HYS}	Temp Protection Hysteresis	—	—	+30	—	°C

Note: 6. Guaranteed by design.

Typical Performance Characteristics (@ $T_A = +25^\circ\text{C}$, $V_{IN} = 16\text{V}$, unless otherwise specified.)

Quiescent Current vs. Input Voltage

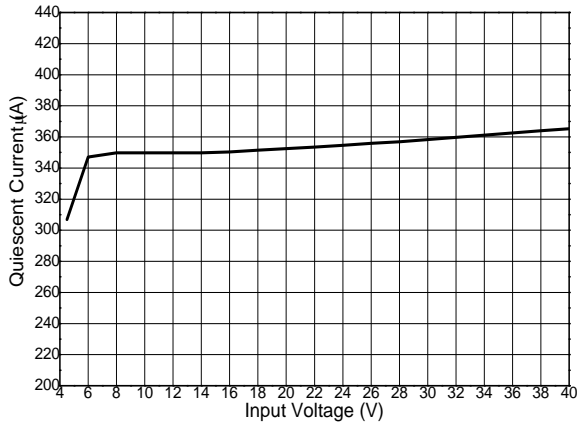

Quiescent Current vs. Temperature

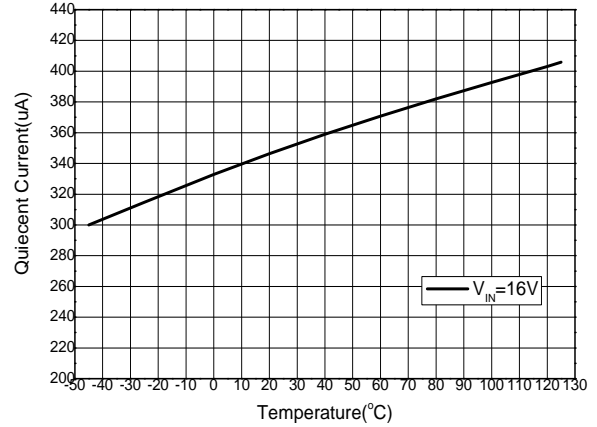

SET Threshold Voltage vs. Input voltage

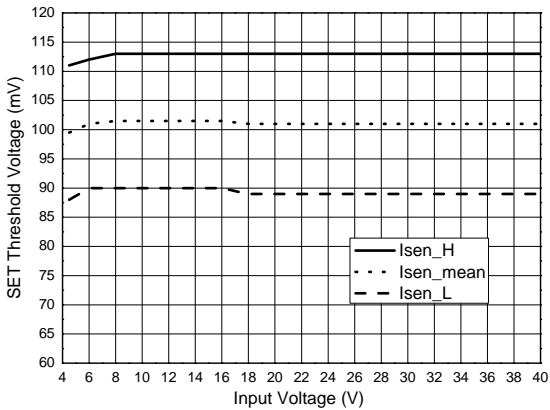

SET Threshold Voltage vs. Temperature

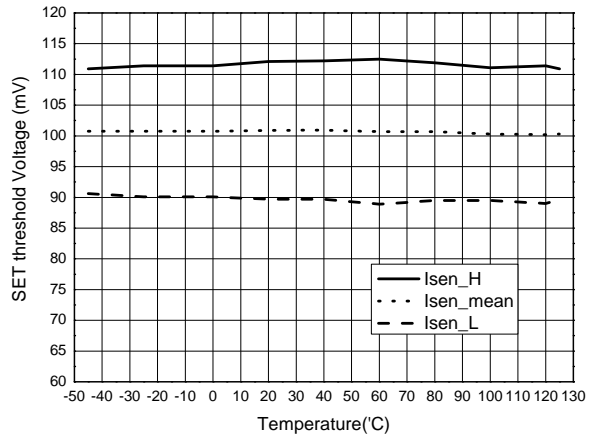

PWM Dimming ($V_{IN} = 16\text{V}$, 3 LEDs, $47\mu\text{H}$, $R_{SET} = 0.3\Omega$)
LED Current vs. Duty Cycle

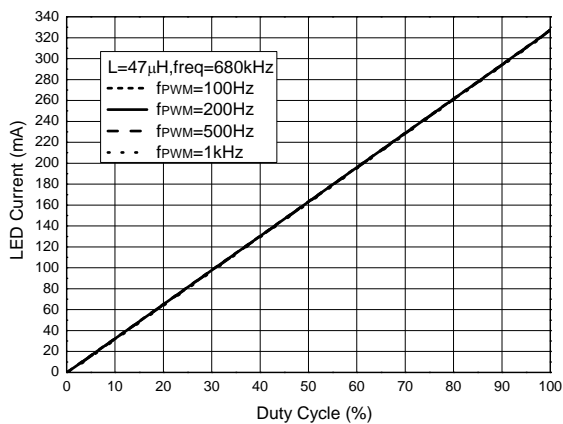

Analog Dimming ($V_{IN} = 16\text{V}$, 3 LEDs, $47\mu\text{H}$, $R_{SET} = 0.3\Omega$)
LED Current vs. CTRL Pin Voltage

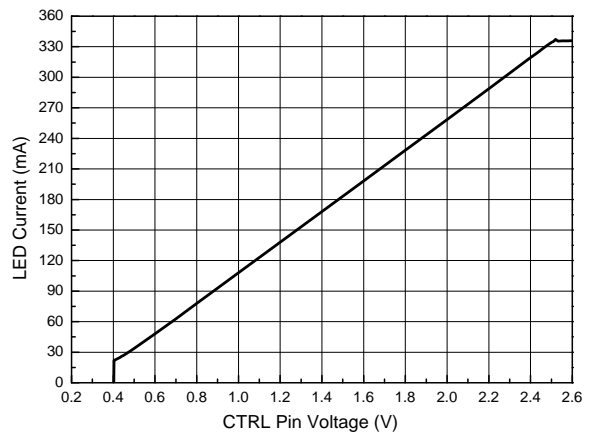

Typical Performance Characteristics (continued) (@ $T_A = +25^\circ\text{C}$, $V_{IN} = 16\text{V}$, unless otherwise specified.)

Efficiency vs. Input Voltage
($R_{SET} = 0.3\Omega$, $L = 100\mu\text{H}$)

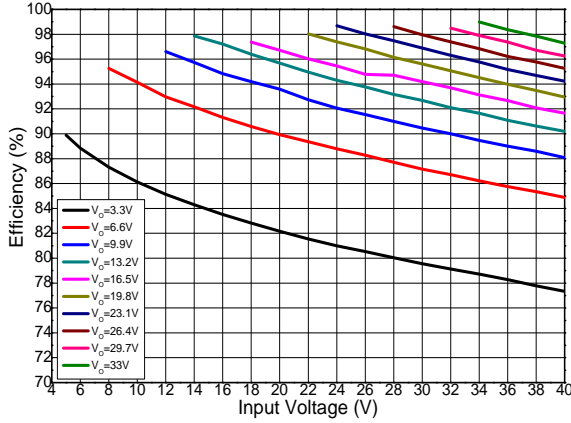

Efficiency vs. Input Voltage
($R_{SET} = 0.15\Omega$, $L = 47\mu\text{H}$)

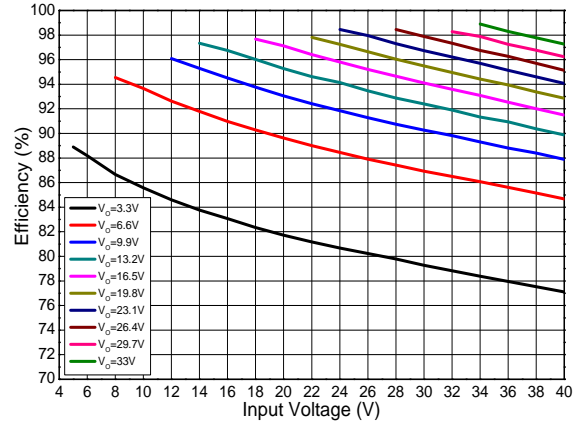

Efficiency vs. Input Voltage
($R_{SET} = 0.1\Omega$, $L = 33\mu\text{H}$)

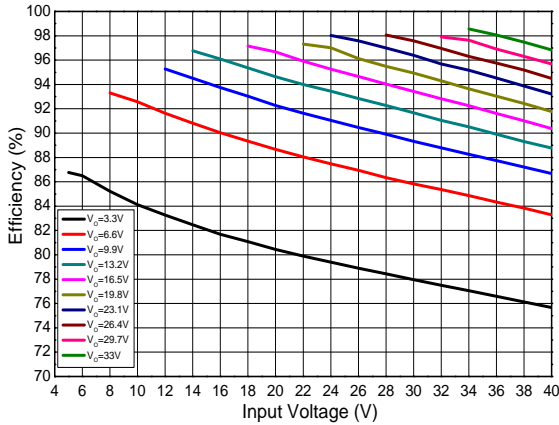

Efficiency vs. Input Voltage
($R_{SET} = 0.067\Omega$, $L = 47\mu\text{H}$)

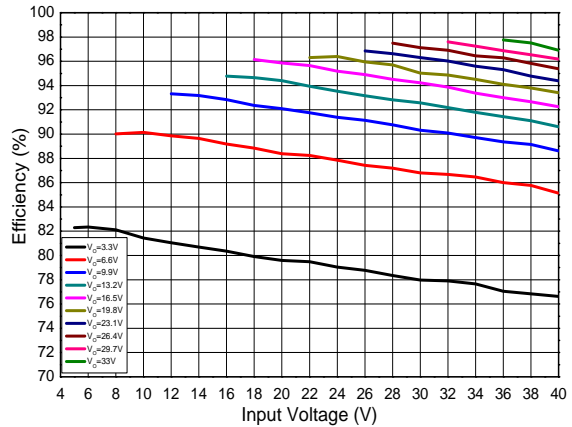

Efficiency vs. Input Voltage
($R_{SET} = 0.05\Omega$, $L = 47\mu\text{H}$)

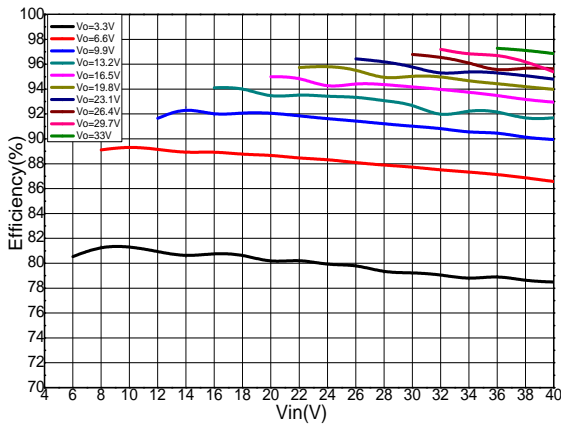

LED Current vs. Input Voltage
($R_{SET} = 0.3\Omega$, $L = 100\mu\text{H}$)

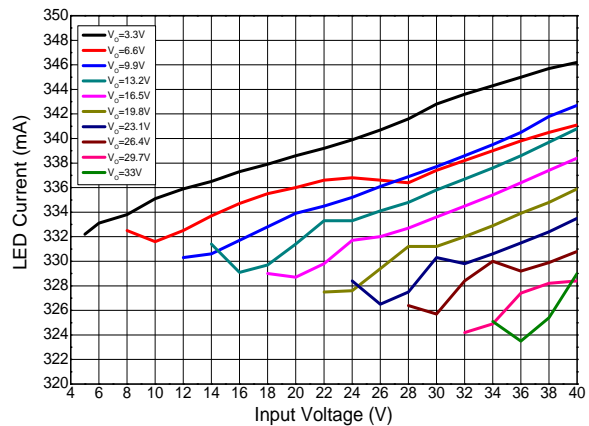

Typical Performance Characteristics (continued) (@ $T_A = +25^\circ\text{C}$, $V_{IN} = 16\text{V}$, unless otherwise specified.)

LED Current vs. Input Voltage
($R_{SET} = 0.15\Omega$, $L = 47\mu\text{H}$)

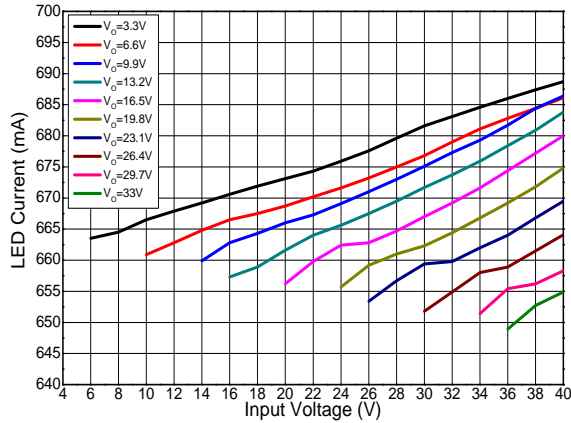

LED Current vs. Input Voltage
($R_{SET} = 0.1\Omega$, $L = 33\mu\text{H}$)

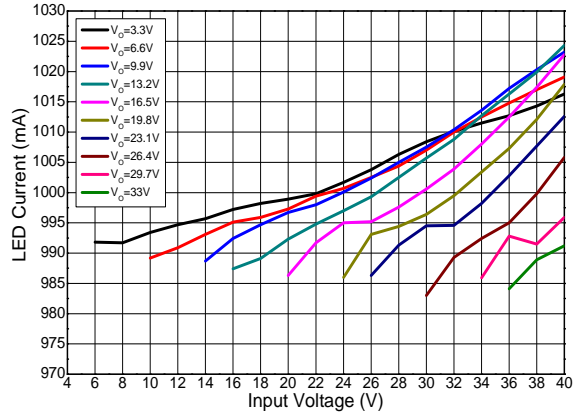

LED Current vs. Input Voltage
($R_{SET} = 0.067\Omega$, $L = 47\mu\text{H}$)

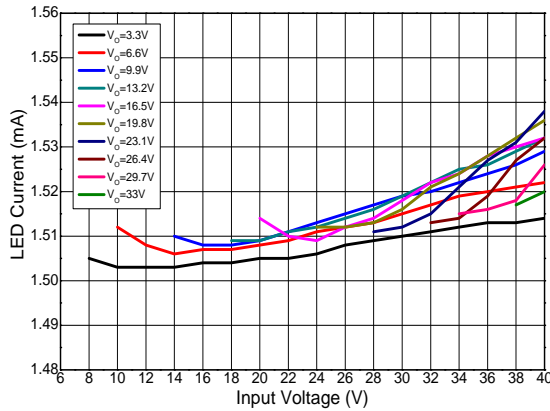

LED Current vs. Input Voltage
($R_{SET} = 0.05\Omega$, $L = 47\mu\text{H}$)

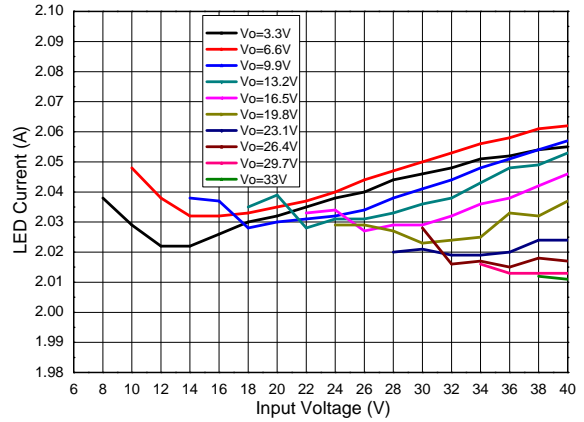

Operating Frequency vs. Input Voltage
($R_{SET} = 0.3\Omega$, $L = 100\mu\text{H}$)

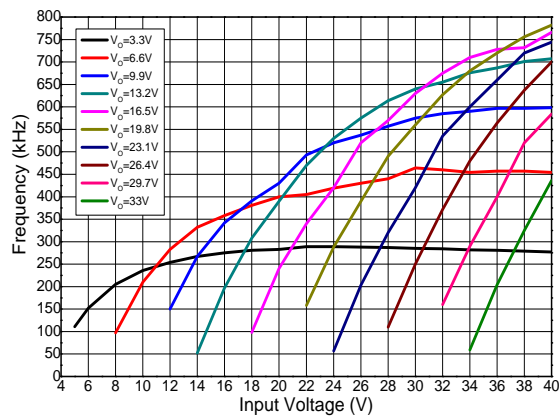

Operating Frequency vs. Input Voltage
($R_{SET} = 0.15\Omega$, $L = 47\mu\text{H}$)

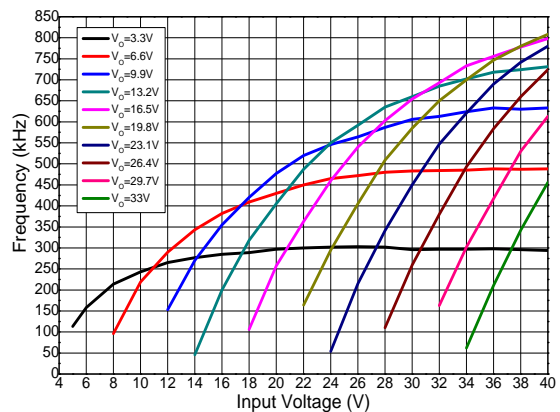

Typical Performance Characteristics (continued) (@T_A = +25°C, V_{IN} = 16V, unless otherwise specified.)

Operating Frequency vs. Input Voltage
(R_{SET} = 0.1Ω, L = 33μH)

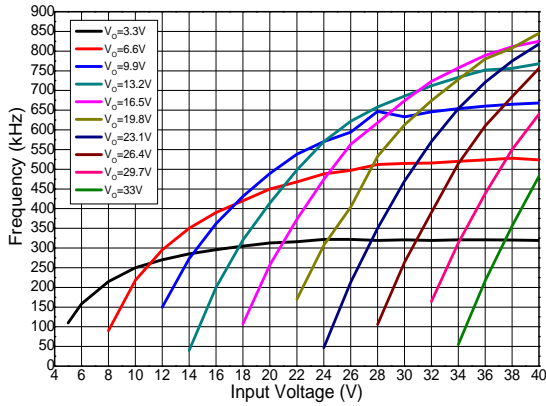

Operating Frequency vs. Input Voltage
(R_{SET} = 0.067Ω, L = 47μH)

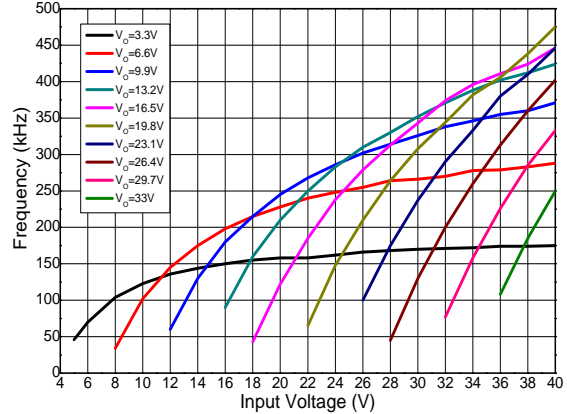

Operating Frequency vs. Input Voltage
(R_{SET} = 0.05Ω, L = 47μH)

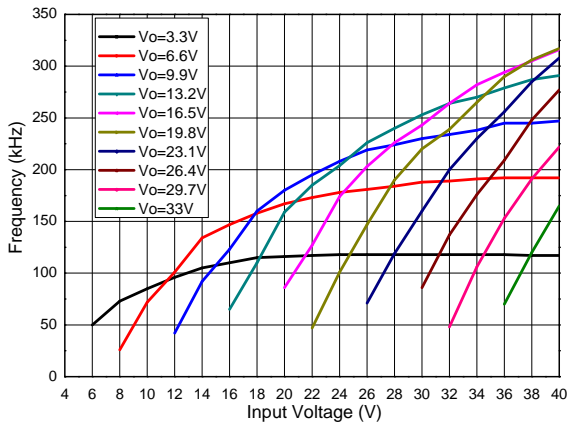

LED Current vs. Output Voltage
(R_{SET} = 0.3Ω, L = 100μH)

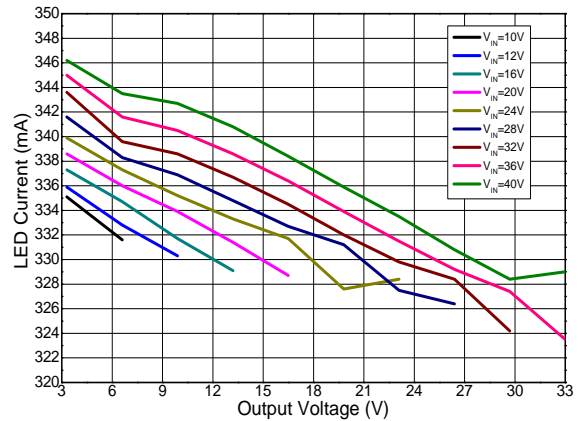

LED Current vs. Output Voltage
(R_{SET} = 0.15Ω, L = 47μH)

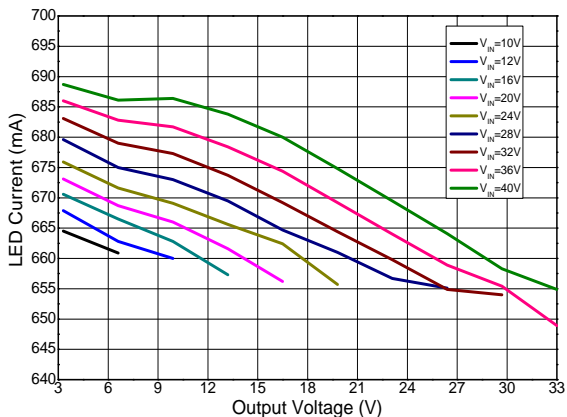

LED Current vs. Output Voltage
(R_{SET} = 0.1Ω, L = 33μH)

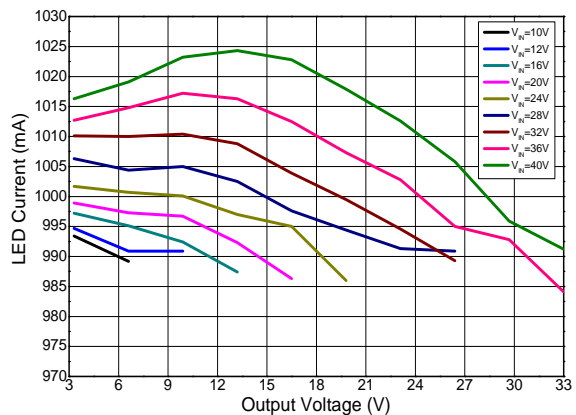

Typical Performance Characteristics (continued) (@ $T_A = +25^\circ\text{C}$, $V_{IN} = 16\text{V}$, unless otherwise specified.)

LED Current vs. Output Voltage
($R_{SET} = 0.067\Omega$, $L = 47\mu\text{H}$)

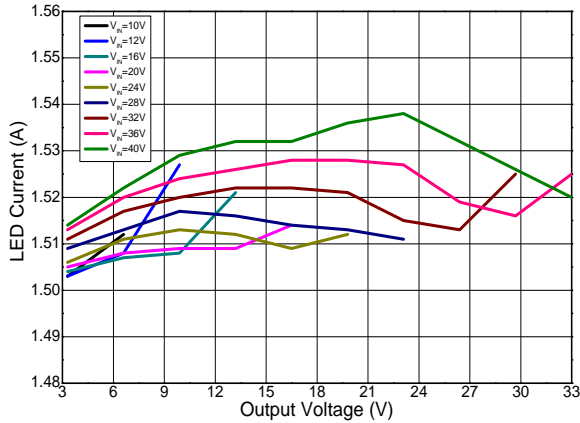

LED Current vs. Output Voltage
($R_{SET} = 0.05\Omega$, $L = 47\mu\text{H}$)

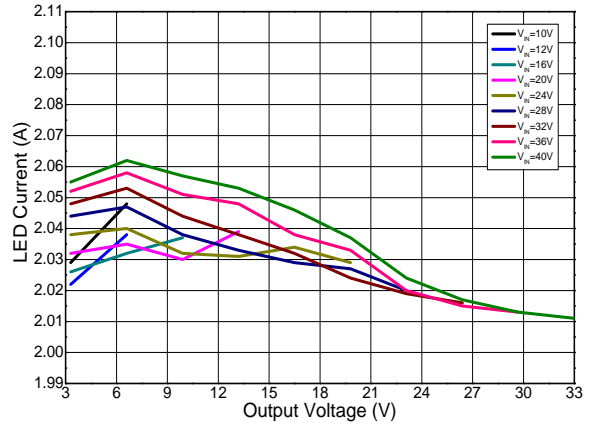

Performance Characteristics (@ $V_{IN} = 16\text{V}$, 3 LEDs, $R_{SET} = 0.3\Omega$, $L = 47\mu\text{H}$, $T_A = +25^\circ\text{C}$, unless otherwise specified.)

Steady State

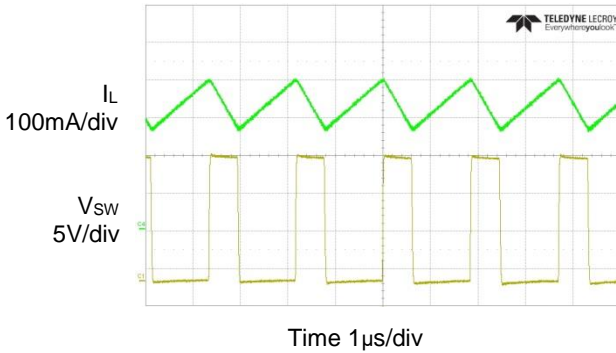

Startup Delay Time

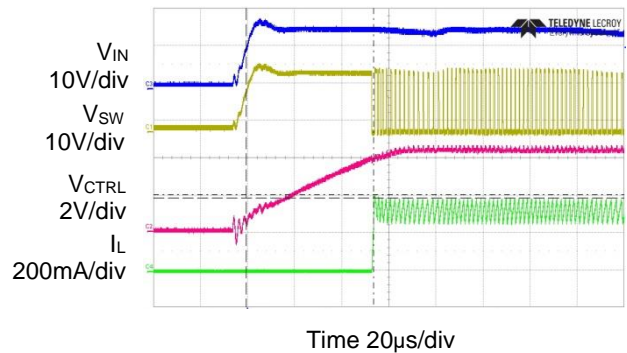

PWM Dimming (100Hz, Duty = 50%)

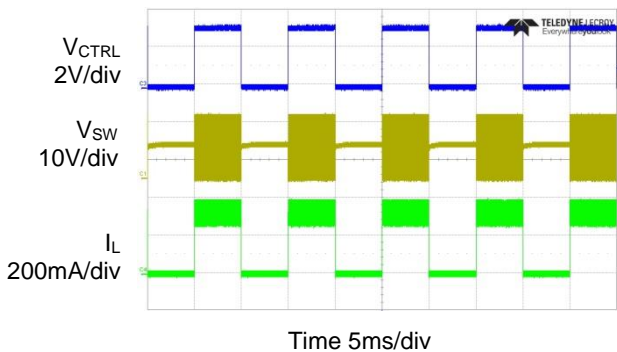

LED Open Protection

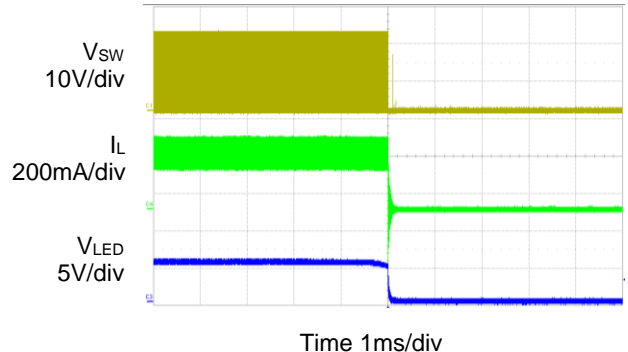

Application Information

AL8843 Operation

In normal operation, when normal input voltage is applied at +V_{IN}, the AL8843 internal switch will turn on. Current starts to flow through sense resistor R_{SET}, inductor L1, and the LEDs. The current ramps up linearly, and the ramp-up rate is determined by the input voltage V_{IN}, V_{OUT} and the inductor L1.

This rising current produces a voltage ramp across R_{SET}. The internal circuit of the AL8843 senses the voltage across R_{SET} and applies a proportional voltage to the input of the internal comparator. When this voltage reaches an internally set upper threshold, the internal switch is turned off. The inductor current continues to flow through R_{SET}, L1, LEDs and diode D1, and back to the supply rail, but it decays, with the rate determined by the forward voltage drop of LEDs and the diode D1.

This decaying current produces a falling voltage on R_{SET}, which is sensed by the AL8843. A voltage proportional to the sense voltage across R_{SET} will be applied at the input of internal comparator. When this voltage falls to the internally set lower threshold, the internal switch is turned on again. This switch-on-and-off cycle continues to provide the average LED current set by the sense resistor R_{SET}.

LED Current Configuration

The nominal average output current in the LED(s) is determined by the value of the external current sense resistor (R_{SET}) connected between V_{IN} and SET and is given by:

$$I_{OUT(NOM)} = \frac{0.1}{R_{SET}}$$

The table below gives values of nominal average output current for several preferred values of current setting resistor (R_{SET}) in the *Typical Application Circuit* shown on Page 2.

R _{SET} (Ω)	Nominal Average Output Current (mA)
0.033	3,000
0.05	2,000
0.067	1,500
0.1	1,000
0.15	667
0.3	333

The above values assume that the CTRL pin is floating and at a nominal reference voltage for internal comparator. It is possible to use different values of R_{SET} if the CTRL pin is driven by an external dimming signal.

Analog Dimming

Applying a DC voltage from 0.4V to 2.5V on the CTRL pin can adjust output current from 10% to 100% of I_{OUT_NOM}, as shown in Figure 1. If the CTRL pin is brought higher than 2.5V, the LED current will be clamped to 100% of I_{OUT_NOM} while if the CTRL voltage falls below the threshold of 0.3V, the output switch will turn off.

PWM Dimming

LED current can be adjusted digitally, by applying a low frequency pulse-width-modulated (PWM) logic signal to the CTRL pin to turn the device on and off. This will produce an average output current proportional to the duty cycle of the control signal. To achieve a high resolution, the PWM frequency is recommended to be lower than 500Hz, however higher dimming frequencies can be used at the expense of dimming dynamic range and accuracy. Typically, for a PWM frequency of 500Hz, the accuracy is better than 1% for PWM ranging from 1% to 100%.

The accuracy of the low duty cycle dimming is affected by both the PWM frequency and the switching frequency of the AL8843. For best accuracy/resolution, the switching frequency should be increased while the PWM frequency should be reduced.

The CTRL pin is designed to be driven by both 3.3V and 5V logic levels directly from a logic output with either an open drain output or push pull output stage.

Application Information (continued)

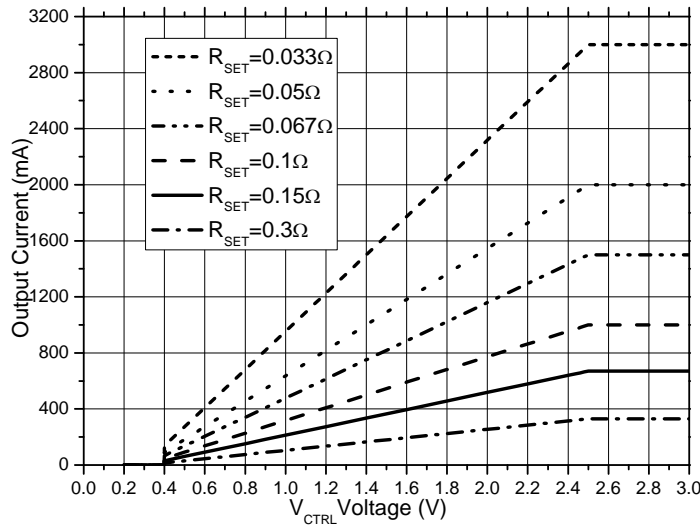

Figure 1. Analog Dimming Curve

Soft-Start

The default soft-start time for AL8843 is only 0.1ms – this provides very fast turn-on of the output, improving PWM dimming accuracy.

Nevertheless, adding an external capacitor from the CTRL pin to Ground will provide a longer soft-start delay. This is achieved by increasing the time for the CTRL voltage rising to the turn-on threshold, and by slowing down the rising rate of the control voltage at the input of hysteresis comparator. The additional soft-start time is related to the capacitance between CTRL and GND, the typical value will be 1.5ms/nF.

Capacitor Selection

A low ESR capacitor should be used for input decoupling, as the ESR of this capacitor appears in series with the supply source impedance and will lower overall efficiency. This capacitor has to supply the relatively high peak current to the coil and smooth the ripple on the input current.

The minimum capacitance needed is determined by input power, cable's length and peak current. 4.7μF to 10μF is a commonly used value for most cases. A higher value will improve performance at lower input voltages, especially when the source impedance is high. The input capacitor should be placed as close as possible to the IC.

For maximum stability of over temperature and voltage, capacitors with X7R, X5R or better dielectric are recommended. Capacitors with Y5V dielectric are not suitable for decoupling in this application and should NOT be used.

Diode Selection

For maximum efficiency and performance, the freewheeling diode (D1) should be a fast low capacitance Schottky diode with low reverse leakage current. It also provides better efficiency than silicon diodes, due to lower forward voltage and reduced recovery time.

It is important to select parts with a peak current rating above the peak coil current, and a continuous current rating higher than the maximum output load current. It is very important to consider the reverse leakage current of the diode when operating above +85°C. Excess leakage current will increase power dissipation.

The higher forward voltage and overshoot due to reverse recovery time in silicon diodes will increase the peak voltage on the SW output. If a silicon diode is used, more care should be taken to ensure that the total voltage appearing on the SW pin including supply ripple, will not exceed the specified maximum value.

Application Information (continued)

Inductor Selection

Recommended inductor values for the AL8843 are in the range 33μH to 100μH. Higher inductance are recommended at higher supply voltages in order to minimize output current tolerance due to switching delays, which will result in increased ripple and lower efficiency. Higher inductance also results in a better line regulation. The inductor should be mounted as close to the device as possible with low resistance connections to SW pins.

The chosen coil should have saturation current higher than the peak output current and a continuous current rating above the required mean output current.

The inductor value should be chosen to maintain operating duty cycle and switch 'on'/'off' times within the specified limits over the supply voltage and load current range. The following equations can be used as a guide.

SW Switch 'On' Time

$$t_{ON} = \frac{L\Delta I}{V_{IN} - V_{LED} - I_{LED}(R_{SET} + R_L + R_{SW})}$$

SW Switch 'Off' Time

$$t_{OFF} = \frac{L\Delta I}{V_{LED} + V_D + I_{LED}(R_{SET} + R_L)}$$

Where: L is the coil inductance; R_L is the coil resistance; R_{SET} is the current sense resistance; I_{LED} is the required LED current; ΔI is the coil peak-peak ripple current (internally set to 0.26 × I_{LED}); V_{IN} is the supply voltage; V_{LED} is the total LED forward voltage; R_{SW} is the switch resistance (0.2Ω nominal); V_D is the diode forward voltage at the required load current.

Thermal Protection

The AL8843 includes Over-Temperature Protection (OTP) circuitry that will turn off the device if its junction temperature gets too high. This is to protect the device from excessive heat damage. The OTP circuitry includes thermal hysteresis that will cause the device to restart normal operation once its junction temperature has cooled down by approximately +30°C.

Open Circuit LEDs

The AL8843 has by default open LED protection. If the LEDs should become open circuit, the AL8843 will stop oscillating; the SET pin will rise to V_{IN} and the SW pin will then fall to GND. No excessive voltages will be seen with the AL8843.

LED Chain Shorted Together

If the LED chain should become shorted together (the anode of the top LED becomes shorted to the cathode of the bottom LED), the AL8843 will continue to switch and the current through the AL8843's internal switch will still be at the expected current - so no excessive heat will be generated within the AL8843. However, the duty cycle at which it operates will change dramatically and the switching frequency will most likely decrease. See Figure 2 for an example of this behavior at 24V input voltage driving 3 LEDs.

The on-time of the internal power MOSFET switch is significantly reduced because almost all of the input voltage is now developed across the inductor. The off-time is significantly increased because the reverse voltage across the inductor is now just the Schottky diode voltage (See Figure 2) causing a much slower decay in inductor current.

Application Information (continued)

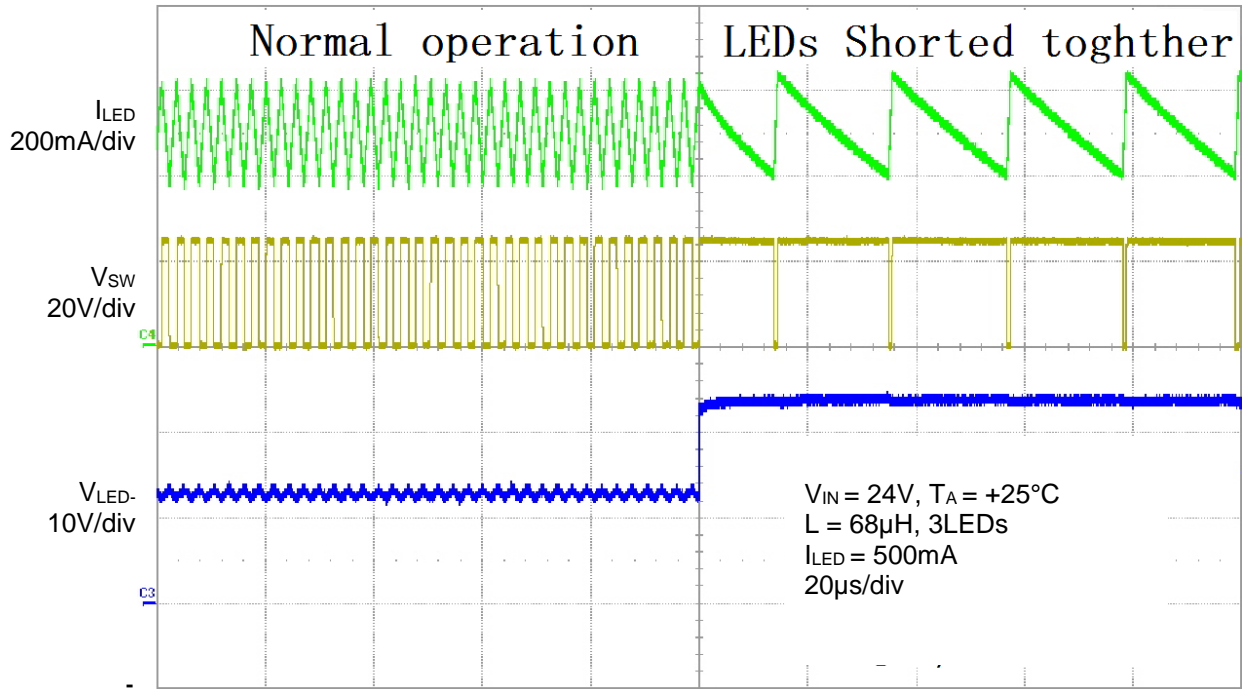
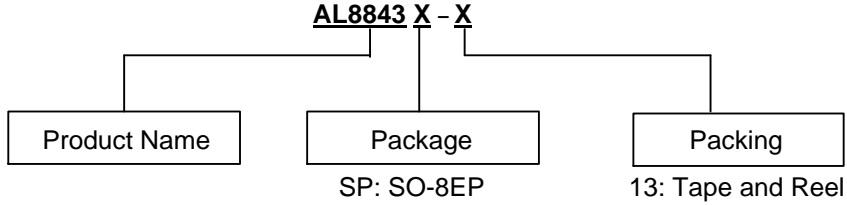

Figure 2. Switching Characteristics (Normal Operation to LED Chain Shorted Out)

Ordering Information



Part Number	Part Number Suffix	Package Code	Package	Packing	
				Qty.	Carrier
AL8843SP-13	-13	SP	SO-8EP	2500	Tape & Reel

Marking Information

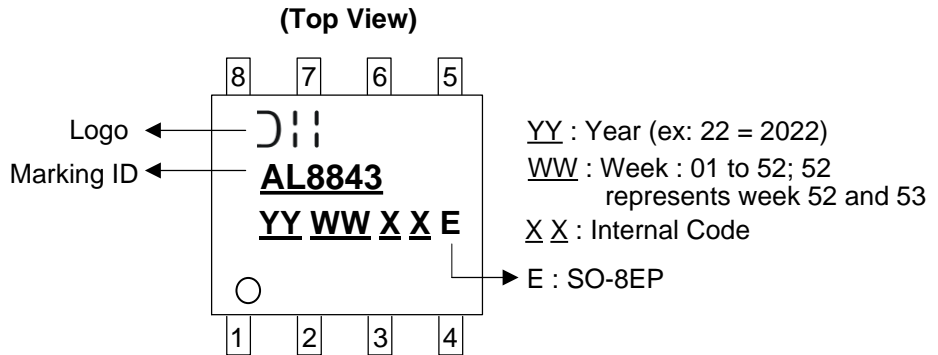

Package Outline Dimensions

Please see <http://www.diodes.com/package-outlines.html> for the latest version.

SO-8EP

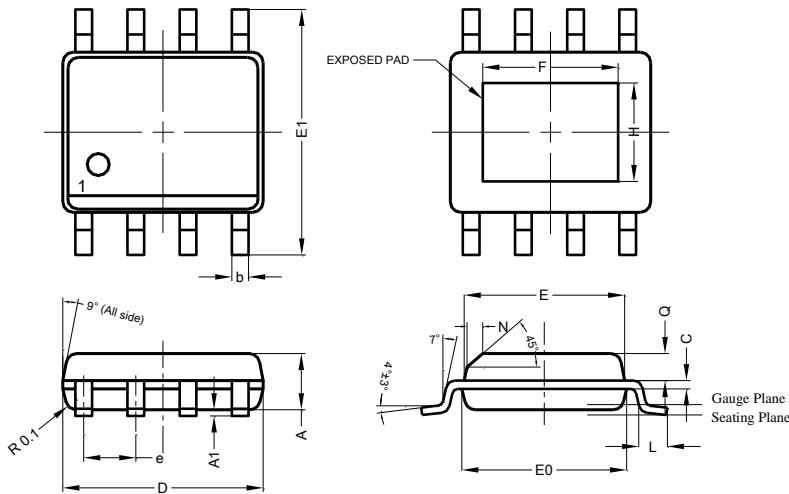

SO-8EP			
Dim	Min	Max	Typ
A	1.40	1.50	1.45
A1	0.00	0.13	-
b	0.30	0.50	0.40
C	0.15	0.25	0.20
D	4.85	4.95	4.90
E	3.80	3.90	3.85
E0	3.85	3.95	3.90
E1	5.90	6.10	6.00
e	-	-	1.27
F	2.75	3.35	3.05
H	2.11	2.71	2.41
L	0.62	0.82	0.72
N	-	-	0.35
Q	0.60	0.70	0.65
All Dimensions in mm			

Suggested Pad Layout

Please see <http://www.diodes.com/package-outlines.html> for the latest version.

SO-8EP

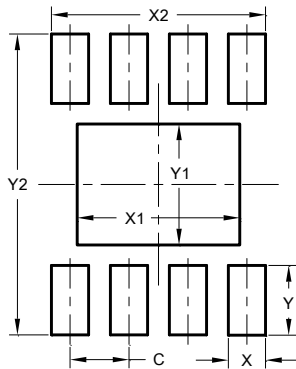

Dimensions	Value (in mm)
C	1.270
X	0.802
X1	3.502
X2	4.612
Y	1.505
Y1	2.613
Y2	6.500

Mechanical Data

- Moisture Sensitivity: Level 1 per JESD22-A113
- Terminals: Finish - Matte Tin Plated Leads, Solderable per M2003 JESD22-B102 Ⓢ
- Weight: 0.081 grams (Approximate)