



PRECISION LOW POWER CMOS OPERATIONAL AMPLIFIER

GENERAL DESCRIPTION

The ALD1722/ALD1722G is a monolithic precision low power CMOS operational amplifier intended for a broad range of precision applications requiring extremely low input signal power. Input signal power is the product of input offset voltage and input bias current, which represents the minimum required power draw from the signal source in order to drive the input of the operational amplifier. Input signal power is also a figure of merit in source loading and its associated error, and is a measure of the basic signal resolution possible through the operational amplifier for a given signal source. For certain types of signal sources, signal loading directly translates into a significant distortion or "interface noise equivalent" term.

The ALD1722/ALD1722G is designed to set a new standard in low input signal power requirements. The typical input loading at its input is 0.03 mV offset voltage and 0.01 pA input bias current at 25°C, resulting in 0.0003 fW input signal power draw. This input characteristic virtually eliminates any loading effects on most types of signal sources, offering unparalleled accuracy and signal integrity and fidelity. Obviously, for capacitive and high sensitivity, high impedance signal sources, the ALD1722/ALD1722G is ideally suited. It is readily suited for +5V single supply (or ±2V to ±5V) systems, with low operating power dissipation, a traditional strength of CMOS technology. It is offered with industry standard pin configuration of μ A741 and ICL7611 types.

The ALD1722/ALD1722G can operate with rail to rail large signal input and output voltages with relatively high slew rate. The input voltage can be equal to or exceed the positive and negative supply voltages while the output voltage can swing close to these supply voltage rails. This feature significantly reduces the supply overhead voltage required to operate the operational amplifier and allows numerous analog serial stages to operate in a low power supply environment. Circuits may operate off the same power supply or battery. This device also features rail-to-rail input and output voltage ranges, tolerance to over-voltage input spikes of 300mV beyond supply rails, high open loop voltage gain, useful bandwidth of 1.5 MHz, slew rate of 2.1 V/ μ s, and low supply current of 0.8mA. Finally, the output stage can typically drive up to 400pF capacitive loads in the unity gain mode and up to 4000 pF capacitive load at a gain of 5.

These features make the ALD1722/ALD1722G a versatile, high precision operational amplifier that is user friendly and easy to use with virtually no source loading and zero input-loading induced source errors. Additionally, robust design and rigorous screening make this device especially suitable for operation in temperature-extreme environments and rugged conditions.

ORDERING INFORMATION ("L" suffix denotes lead-free (RoHS))

Operating Temperature Range		
0°C to +70°C	0°C to +70°C	-55°C to +125°C
8-Pin Small Outline Package (SOIC)	8-Pin Plastic Dip Package	8-Pin CERDIP Package
ALD1722SAL	ALD1722PAL	ALD1722DA
ALD1722GSAL	ALD1722GPAL	ALD1722GDA

* Contact factory for leaded (non-RoHS) or high temperature versions.

FEATURES & BENEFITS

- Lead Free - RoHS compatible
- Robust high-temperature operation
- Industry standard pinout
- Rail-to-rail input/output
- Extremely low input signal power
- Input bias current of 0.01pA and input offset voltage of 25 μ V
- No external components
- No internal chopper clocking noise
- No chopper dynamic power dissipation
- Simple and cost effective
- Small package size
- Drive up to 4000pF load capacitance
- Low power
- Suitable for rugged, temperature-extreme environments

APPLICATIONS

- Precision cable driver
- Sensor interface circuits
- Unity gain buffer amplifier
- Precision analog cable driver
- Transducer biasing circuits
- Capacitive and charge integration circuits
- Biochemical probe interface
- Signal conditioning
- Portable instruments
- High source impedance electrode amplifiers
- Precision Sample and Hold amplifiers
- Precision current to voltage converter
- Error correction circuits
- Sensor compensation circuits
- Precision gain amplifiers
- System output level shifter

PIN CONFIGURATION

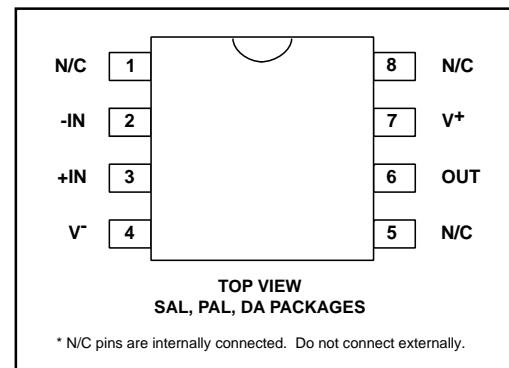

ABSOLUTE MAXIMUM RATINGS

Supply voltage, V+	_____	10.6V
Differential input voltage range	_____	-0.3V to V+ +0.3V
Power dissipation	_____	600 mW
Operating temperature range	SAL, PAL packages _____	0°C to +70°C
	DA package _____	-55°C to +125°C
Storage temperature range	_____	-65°C to +150°C
Lead temperature, 10 seconds	_____	+260°C

CAUTION: ESD Sensitive Device. Use static control procedures in ESD controlled environment.

OPERATING ELECTRICAL CHARACTERISTICS

T_A = 25°C V_S = ±2.5V unless otherwise specified

Parameter	Symbol	1722			1722G			Unit	Test Conditions
		Min	Typ	Max	Min	Typ	Max		
Supply Voltage	V _S	±2.0		±5.0	±2.0		±5.0	V	Single Supply
	V+	4.0		10.0	4.0		10.0	V	
Input Offset Voltage	V _{OS}		25	90		80	400	μV	R _S ≤ 100KΩ
Input Offset Current	I _{OS}		0.01	10 280		0.01	10 280	pA pA	T _A = 25°C 0°C ≤ T _A ≤ +70°C
Input Bias Current	I _B		0.01	10 280		0.01	10 280	pA pA	T _A = 25°C 0°C ≤ T _A ≤ +70°C
Input Voltage Range	V _{IR}	-0.3		+5.3	-0.3		+5.3	V	V+ = +5V V _S = ±2.5V
		-2.8		+2.8	-2.8		+2.8	V	
Input Resistance	R _{IN}		10 ¹⁴			10 ¹⁴		Ω	
Input Offset Voltage Drift	TCV _{OS}		4			7		μV/°C	R _S ≤ 100KΩ
Power Supply Rejection Ratio	PSRR		85			85		dB	R _S ≤ 100KΩ
Common Mode Rejection Ratio	CMRR		97			97		dB	R _S ≤ 100KΩ
Large Signal Voltage Gain	A _v	50	250		50	250		V/mV	R _L = 10KΩ R _L ≥ 1MΩ
			500			500		V/mV	
Output Voltage Range	V _O low		0.002	0.01		0.002	0.01	V	R _L = 1MΩ V+ = 5V 0°C ≤ T _A ≤ +70°C
	V _O high	4.99	4.998		4.99	4.998		V	
	V _O low		-2.44	-2.35		-2.44	-2.35	V	
	V _O high	2.35	2.44		2.35	2.44		V	
Output Short Circuit Current	I _{SC}		8			8		mA	
Supply Current	I _S		0.8	1.5		0.8	1.5	mA	V _{IN} = 0V No Load
Power Dissipation	P _D		4.0	7.5		4.0	7.5	mW	V _S = ±2.5V
Input Capacitance	C _{IN}		1			1		pF	
Maximum Load Capacitance	C _L		400			400		pF	Gain = 1 Gain = 5
			4000			4000		pF	
Input Noise Voltage	e _n		26			26		nV/√ Hz	f = 1KHz
Input Current Noise	i _n		0.6			0.6		fA/√ Hz	f = 10Hz

OPERATING ELECTRICAL CHARACTERISTICS (cont'd)

T_A = 25°C V_S = ±2.5V unless otherwise specified (cont'd)

Parameter	Symbol	1722			1722G			Unit	Test Conditions
		Min	Typ	Max	Min	Typ	Max		
Bandwidth	B _W	1.0	1.5		1.0	1.5		MHz	
Slew Rate	S _R	1.4	2.1		1.4	2.1		V/μs	A _V = +1 R _L = 10KΩ
Rise time	t _r		0.2			0.2		μs	R _L = 10KΩ
Overshoot Factor			10			10		%	R _L = 10KΩ, C _L = 100pF
Settling Time	t _s		8.0 3.0			8.0 3.0		μs μs	0.01% 0.1% A _V = -1, R _L = 5KΩ C _L = 50pF

T_A = 25°C V_S = ±5.0V unless otherwise specified

Parameter	Symbol	1722			1722G			Unit	Test Conditions
		Min	Typ	Max	Min	Typ	Max		
Power Supply Rejection Ratio	PSRR		85			85		dB	R _S ≤ 100KΩ
Common Mode Rejection Ratio	CMRR		97			97		dB	R _S ≤ 100KΩ
Large Signal Voltage Gain	A _V		250			250		V/mV	R _L = 10KΩ
Output Voltage Range	V _O low V _O high	4.80	-4.90 4.93	-4.80	4.80	-4.90 4.93	-4.80	V	R _L = 10KΩ
Bandwidth	B _W		1.7			1.7		MHz	
Slew Rate	S _R		2.8			2.8		V/μs	A _V = +1, C _L = 50pF

V_S = ±2.5V -55°C ≤ T_A ≤ +125°C unless otherwise specified

Parameter	Symbol	1722			1722G			Unit	Test Conditions
		Min	Typ	Max	Min	Typ	Max		
Input Offset Voltage	V _{OS}		0.5	2.0		0.7	3.5	mV	R _S ≤ 100KΩ
Input Offset Current	I _{OS}			2.0			2.0	nA	
Input Bias Current	I _B			2.0			2.0	nA	
Power Supply Rejection Ratio	PSRR		85			85		dB	R _S ≤ 100KΩ
Common Mode Rejection Ratio	CMRR		97			97		dB	R _S ≤ 100KΩ
Large Signal Voltage Gain	A _V	10	25		10	25		V/mV	R _L ≤ 10KΩ
Output Voltage Range	V _O low V _O high	2.30	-2.40 2.40	-2.30	2.30	-2.40 2.40	-2.30	V V	R _L ≤ 10KΩ

Design & Operating Notes:

1. The ALD1722/ALD1722G CMOS operational amplifier uses a 3 gain stage architecture and an improved frequency compensation scheme to achieve large voltage gain, high output driving capability, and better frequency stability. In a conventional CMOS operational amplifier design, compensation is achieved with a pole splitting capacitor together with a nulling resistor. This method is, however, very bias dependent and thus cannot accommodate the large range of supply voltage operation as is required from a stand alone CMOS operational amplifier. The ALD1722/ALD1722G is internally compensated for unity gain stability using a novel scheme that does not use a nulling resistor. This scheme produces a clean single pole roll off in the gain characteristics while providing for more than 70 degrees of phase margin at the unity gain frequency. A unity gain buffer using the ALD1722/ALD1722G will typically drive 400pF of external load capacitance without stability problems. In the inverting unity gain configuration, it can drive up to 800pF of load capacitance. Compared to other CMOS operational amplifiers, the ALD1722/ALD1722G has shown itself to be more resistant to parasitic oscillations.
2. The ALD1722/ALD1722G has complementary p-channel and n-channel input differential stages connected in parallel to accomplish rail to rail input common mode voltage range. This means that with the ranges of common mode input voltage close to the power supplies, one of the two differential stages is switched off internally. To maintain compatibility with other operational amplifiers, this switching point has been selected to be about 1.5V above the negative supply voltage. Since offset voltage trimming on the ALD1722/ALD1722G is made when the input voltage is symmetrical to the supply voltages, this internal switching does not affect a large variety of applications such as an inverting amplifier or non-inverting amplifier with a gain larger than 2.5 (5V operation), where the common mode voltage does not make excursions below this switching point. The user should however, be aware that this switching does take place if the operational amplifier is connected as a unity gain buffer and should make provision in his design to allow for input offset voltage variations.
3. The input bias and offset currents are essentially input protection diode reverse bias leakage currents, and are typically less than 1pA at room temperature. This low input bias current assures that the analog signal from the source will not be distorted by input bias currents. Normally, this extremely high input impedance of greater than $10^{14}\Omega$ would not be a problem as the source impedance would limit the node impedance. However, for applications where source impedance is very high, it may be necessary to limit noise and hum pickup through proper shielding.
4. The output stage consists of class AB complementary output drivers, capable of driving a low resistance load. The output voltage swing is limited by the drain to source on-resistance of the output transistors as determined by the bias circuitry, and the value of the load resistor. When connected in the voltage follower configuration, the oscillation resistant feature, combined with the rail to rail input and output feature, makes an effective analog signal buffer for medium to high source impedance sensors, transducers, and other circuit networks.
5. ALD1722/ALD1722G operational amplifier has been designed to provide full static discharge protection. Internally, the design has been carefully implemented to minimize latch up. However, care must be exercised when handling the device to avoid strong static fields that may degrade a diode junction, causing increased input leakage currents. In using the operational amplifier, the user is advised to power up the circuit before, or simultaneously with, any input voltages applied and to limit input voltages to not exceed 0.3V of the power supply voltage levels.
6. The ALD1722/ALD1722G has an internal design architecture that provides robust high temperature operation. Contact factory for custom screening versions.

TYPICAL PERFORMANCE CHARACTERISTICS

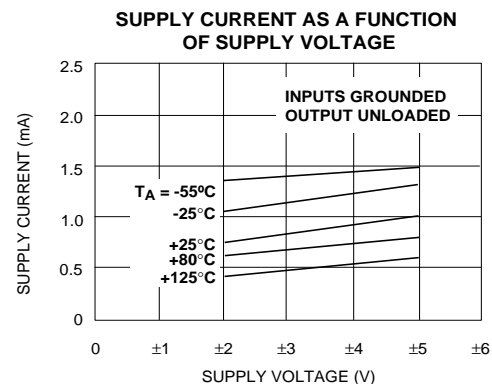
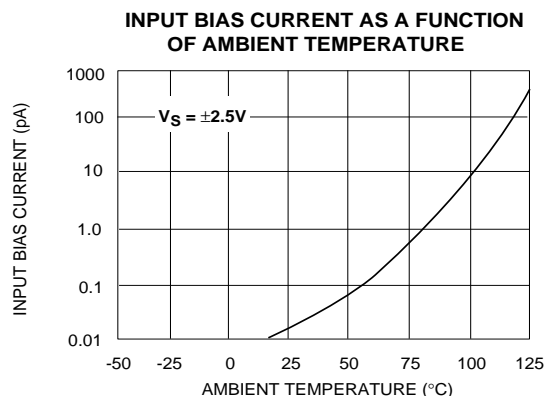
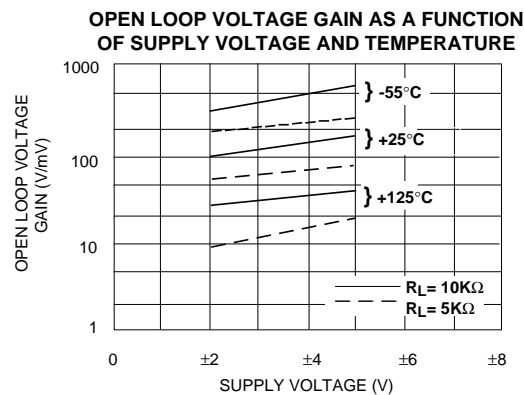
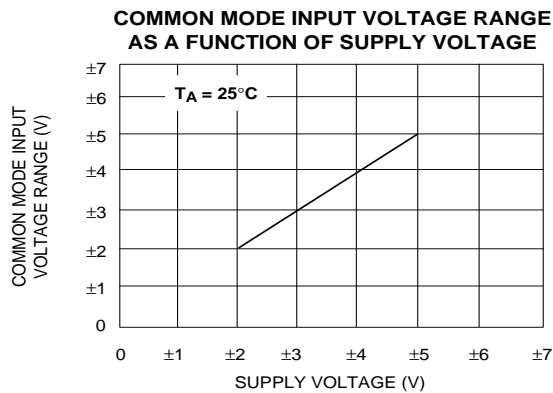

TYPICAL PERFORMANCE CHARACTERISTICS (cont'd)

OUTPUT VOLTAGE SWING AS A FUNCTION OF SUPPLY VOLTAGE

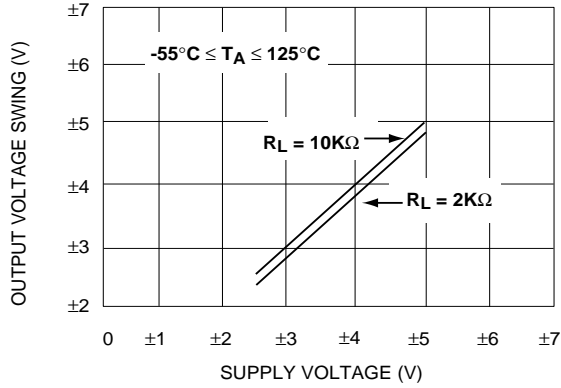

OPEN LOOP VOLTAGE AS A FUNCTION OF FREQUENCY

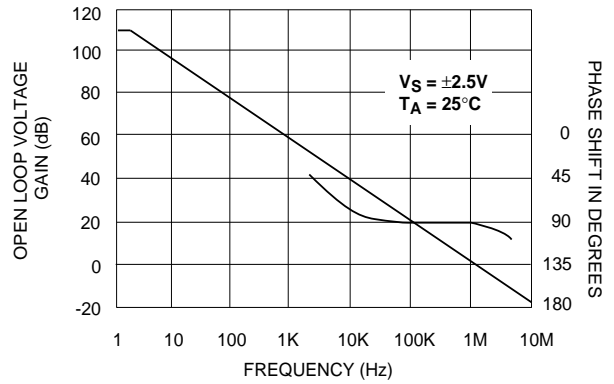

OPEN LOOP VOLTAGE GAIN AS A FUNCTION OF LOAD RESISTANCE

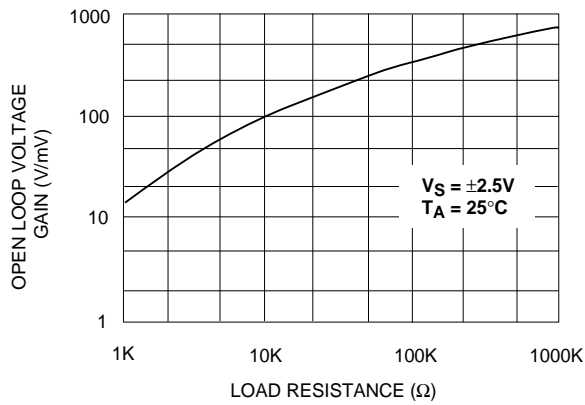

LARGE - SIGNAL TRANSIENT RESPONSE

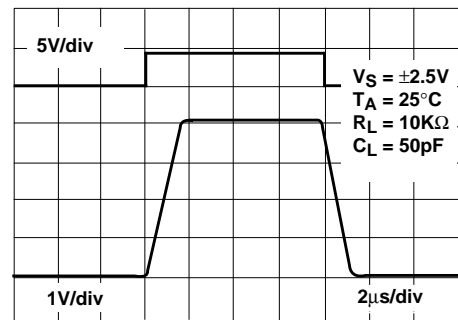

SMALL - SIGNAL TRANSIENT RESPONSE

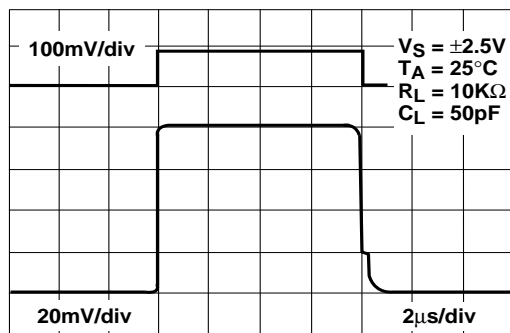

TYPICAL APPLICATIONS

RAIL TO RAIL VOLTAGE FOLLOWER/BUFFER

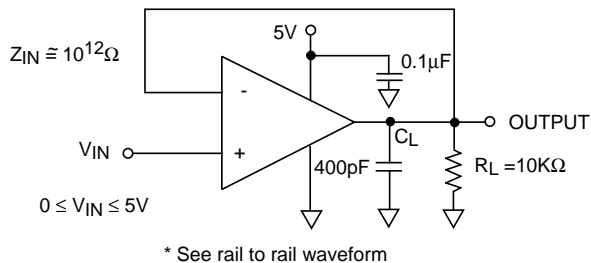

RAIL-TO-RAIL WAVEFORM

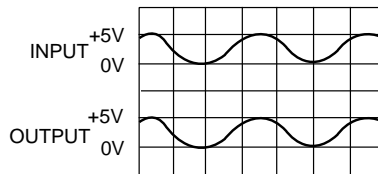

Performance waveforms.
Upper trace is the output of a Wien Bridge Oscillator. Lower trace is the output of Rail-to-rail voltage follower.

LOW OFFSET SUMMING AMPLIFIER

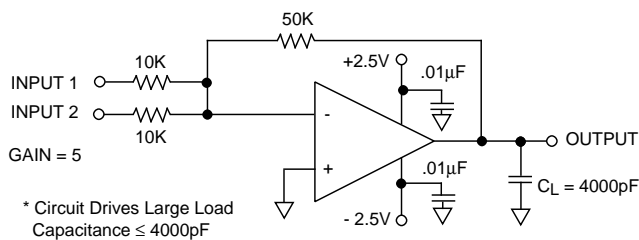
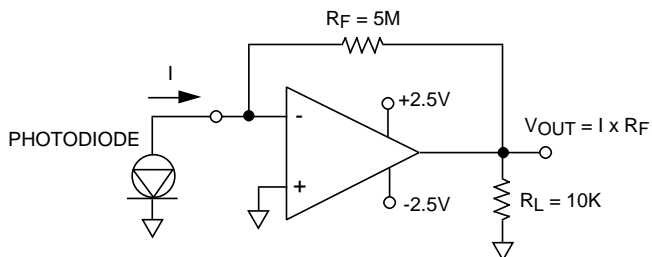
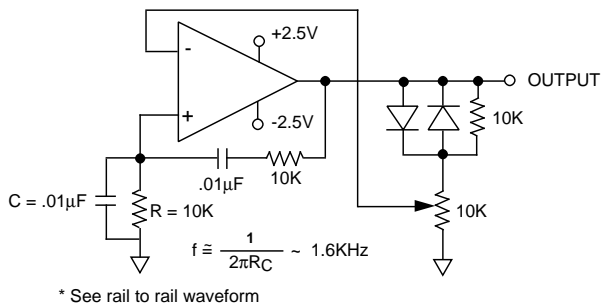

PHOTO DETECTOR CURRENT TO VOLTAGE CONVERTER



WIEN BRIDGE OSCILLATOR (RAIL-TO-RAIL) SINE WAVE GENERATOR



RAIL-TO-RAIL VOLTAGE COMPARATOR

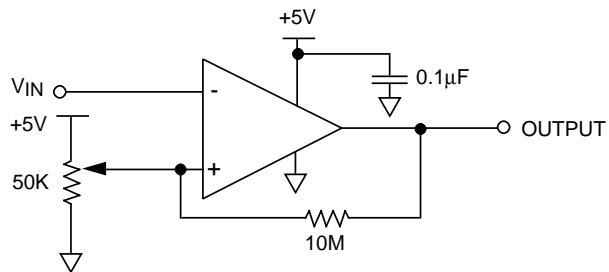

SOIC-8 PACKAGE DRAWING

8 Pin Plastic SOIC Package

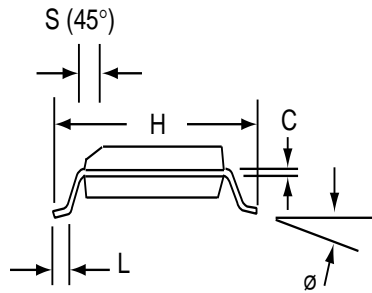
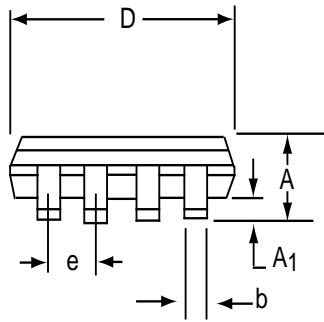
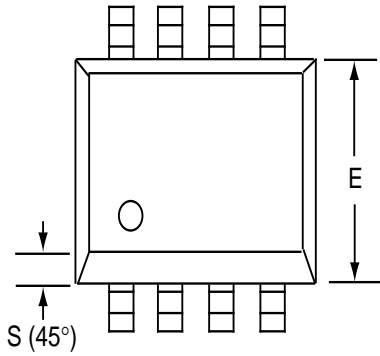

Dim	Millimeters		Inches	
	Min	Max	Min	Max
A	1.35	1.75	0.053	0.069
A ₁	0.10	0.25	0.004	0.010
b	0.35	0.45	0.014	0.018
C	0.18	0.25	0.007	0.010
D-8	4.69	5.00	0.185	0.196
E	3.50	4.05	0.140	0.160
e	1.27 BSC		0.050 BSC	
H	5.70	6.30	0.224	0.248
L	0.60	0.937	0.024	0.037
∅	0°	8°	0°	8°
S	0.25	0.50	0.010	0.020

PDIP-8 PACKAGE DRAWING

8 Pin Plastic DIP Package

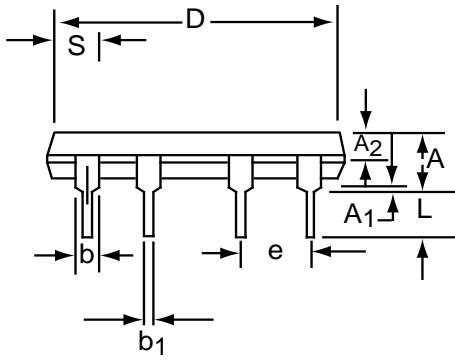
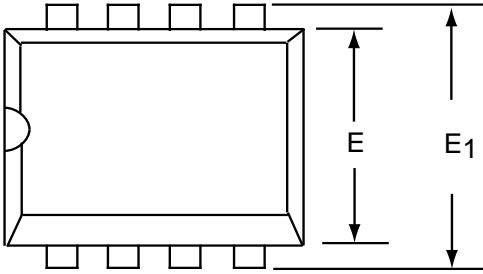

Dim	Millimeters		Inches	
	Min	Max	Min	Max
A	3.81	5.08	0.105	0.200
A ₁	0.38	1.27	0.015	0.050
A ₂	1.27	2.03	0.050	0.080
b	0.89	1.65	0.035	0.065
b ₁	0.38	0.51	0.015	0.020
c	0.20	0.30	0.008	0.012
D-8	9.40	11.68	0.370	0.460
E	5.59	7.11	0.220	0.280
E ₁	7.62	8.26	0.300	0.325
e	2.29	2.79	0.090	0.110
e ₁	7.37	7.87	0.290	0.310
L	2.79	3.81	0.110	0.150
S-8	1.02	2.03	0.040	0.080
∅	0°	15°	0°	15°

