



## DUAL 5V RAIL-TO-RAIL PRECISION OPERATIONAL AMPLIFIER

### GENERAL DESCRIPTION

The ALD2702A/ALD2702B/ALD2702 is a dual monolithic operational amplifier intended primarily for a wide range of analog applications in +5V single power supply and  $\pm 5V$  dual power supply systems as well as +4V to +10V battery operated systems. All device characteristics are specified for +5V single supply or  $\pm 2.5V$  dual supply systems. The device has an input stage that operates to +300mV above and -300mV below the supply voltages with no adverse effects and/or phase reversals. It offers popular industry pin configuration.

The ALD2702A/ALD2702B/ALD2702 has been developed specifically with the +5V single supply or  $\pm 2.5V$  dual supply user in mind. Several important characteristics of the device make many applications easy to implement for these supply voltages. First, the operational amplifier can operate with rail to rail input and output voltages. This feature allows numerous analog serial stages to be implemented without losing operating voltage margin. Second, the device was designed to accommodate mixed applications where digital and analog circuits may work off the same 5V power supply. Third, the output stage can drive up to 400pF capacitive and 5K $\Omega$  resistive loads in non-inverting unity gain connection and double the capacitance in the inverting unity gain mode.

These features, coupled with extremely low input currents, high voltage gain, useful bandwidth of 1.5MHz, a slew rate of 1.9V/ $\mu s$ , low power dissipation, low offset voltage and temperature drift, make the ALD2702A/ALD2702B/ALD2702 a truly versatile, user friendly, operational amplifier.

The ALD2702A/ALD2702B/ALD2702 is designed and fabricated with silicon gate CMOS technology, and offers less than 1pA typical input bias current. On-chip offset voltage trimming allows the device to be used without nulling in most applications. The device offers typical offset drift of less than 7 $\mu V/^{\circ}C$  which eliminates many trim or temperature compensation circuits. For precision applications, the ALD2702A/ALD2702B/ALD2702 is designed to settle to 0.01% in 8 $\mu s$ . Additionally, robust design and rigorous screening make this device especially suitable for operation in temperature-extreme environments and rugged conditions.

### ORDERING INFORMATION ("L" suffix denotes lead-free (RoHS))

Operating Temperature Range		
0 $^{\circ}C$ to +70 $^{\circ}C$	0 $^{\circ}C$ to +70 $^{\circ}C$	-55 $^{\circ}C$ to 125 $^{\circ}C$
8-Pin Small Outline Package (SOIC)	8-Pin Plastic Dip Package	8-Pin CERDIP Package
ALD2702ASAL	ALD2702APAL	ALD2702ADA
ALD2702BSAL	ALD2702BPAL	ALD2702BDA
ALD2702SAL	ALD2702PAL	ALD2702DA

\* Contact factory for leaded (non-RoHS) or high temperature versions.

### FEATURES

- Rail-to-rail input and output voltage ranges
- Symmetrical push-pull class AB output drivers
- All parameters specified for +5V single supply or  $\pm 2.5V$  dual supply systems
- High load capacitance capability -- drives up to 4000pF typical
- No frequency compensation required -- unity gain stable
- Extremely low input bias currents -- <1.0pA typical
- Ideal for high source impedance applications
- Dual power supply  $\pm 2.5V$  to  $\pm 5V$  operation
- Single power supply +5V to +10V operation
- High voltage gain -- typically 85V/mV @  $\pm 2.5V$  and 250V/mV @  $\pm 5.0V$
- Drive as low as 2K $\Omega$  load with 5mA drive current
- Output short circuit protected
- Unity gain bandwidth of 1.5MHz
- Slew rate of 1.9V/ $\mu s$
- Low power dissipation
- Suitable for rugged, temperature-extreme environments

### APPLICATIONS

- Voltage follower/buffer
- Charge integrator
- Photodiode amplifier
- Data acquisition systems
- High performance portable instruments
- Signal conditioning circuits
- Sensor and transducer amplifiers
- Low leakage amplifiers
- Active filters
- Sample/Hold amplifier
- Picoammeter
- Current to voltage converter
- Coaxial cable driver

### PIN CONFIGURATION

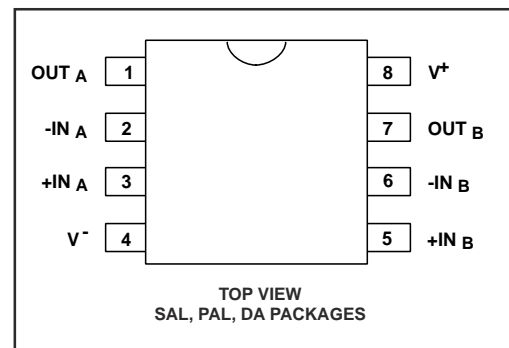

## ABSOLUTE MAXIMUM RATINGS

Supply voltage, $V_+$ referenced to $V_-$	-0.3V to $V_+ + 10.6V$
Supply voltage, $V_S$ referenced to $V_-$	$\pm 5.3V$
Differential input voltage range	-0.3V to $V_+ + 0.3V$
Power dissipation	600 mW
Operating temperature range	SAL, PAL packages: $0^\circ C$ to $+70^\circ C$ DA package: $-55^\circ C$ to $+125^\circ C$
Storage temperature range	$-65^\circ C$ to $+150^\circ C$
Lead temperature, 10 seconds	$+260^\circ C$

**CAUTION:** ESD Sensitive Device. Use static control procedures in ESD controlled environment.

## OPERATING ELECTRICAL CHARACTERISTICS

$T_A = 25^\circ C$   $V_S = \pm 2.5V$  unless otherwise specified

Parameter	Symbol	2702A			2702B			2702			Unit	Test Conditions
		Min	Typ	Max	Min	Typ	Max	Min	Typ	Max		
Supply Voltage	$V_S$ $V_+$	$\pm 2.0$ 4.0		$\pm 5.0$ 10.0	$\pm 2.0$ 4.0		$\pm 5.0$ 10.0	$\pm 2.0$ 4.0		$\pm 5.0$ 10.0	V V	Dual Supply Single Supply
Input Offset Voltage	$V_{OS}$			1.0 1.5			2.0 3.0			5.0 6.0	mV mV	$R_S \leq 100K\Omega$ $0^\circ C \leq T_A \leq +70^\circ C$
Input Offset Current	$I_{OS}$		1.0	20 240		1.0	20 240		1.0	20 240	pA pA	$T_A = 25^\circ C$ $0^\circ C \leq T_A \leq +70^\circ C$
Input Bias Current	$I_B$		1.0	20 300		1.0	20 300		1.0	20 300	pA pA	$T_A = 25^\circ C$ $0^\circ C \leq T_A \leq +70^\circ C$
Input Voltage Range	$V_{IR}$	-0.3 -2.8		5.3 +2.8	-0.3 -2.8		5.3 +2.8	-0.3 -2.8		5.3 +2.8	V V	$V_+ = +5V$ $V_S = \pm 2.5V$
Input Resistance	$R_{IN}$		$10^{12}$			$10^{12}$			$10^{12}$		$\Omega$	
Input Offset Voltage Drift	$TCV_{OS}$		7			7			7		$\mu V/^\circ C$	$R_S \leq 100K\Omega$
Power Supply Rejection Ratio	PSRR	65 65	83 83		65 65	83 83		63 63	83 83		dB	$R_S \leq 100K\Omega$ $0^\circ C \leq T_A \leq +70^\circ C$
Common Mode Rejection Ratio	CMRR	65 65	83 83		65 65	83 83		63 63	83 83		dB	$R_S \leq 100K\Omega$ $0^\circ C \leq T_A \leq +70^\circ C$
Large Signal Voltage Gain	$A_V$	15	28 100		15	28 100		12	28 100		V/mV V/mV	$R_L = 10K\Omega$ $R_L \geq 1M\Omega$
Output Voltage Range	$V_{O\ low}$ $V_{O\ high}$	4.99	4.998	0.01	4.99	4.998	0.01	4.99	4.998	0.01	V	$R_L = 1M\Omega$ Single supply $0^\circ C \leq T_A \leq +70^\circ C$
	$V_{O\ low}$ $V_{O\ high}$	2.40	-2.44 2.44	-2.40	2.40	-2.44 2.44	-2.40	2.40	-2.44 2.44	-2.40	V V	$R_L = 10K\Omega$ Dual supply $0^\circ C \leq T_A \leq +70^\circ C$
Output Short Circuit Current	$I_{SC}$		8			8			8		mA	
Supply Current	$I_S$		2.0	3.0		2.0	3.0		2.0	3.0	mA	$V_{IN} = 0V$ No Load
Power Dissipation	$P_D$		10	15.0		10	15.0		10	15.0	mW	Both amplifiers $V_S = \pm 2.5V$
Input Capacitance	$C_{IN}$		1			1			1		pF	
Bandwidth	$B_W$	0.7	1.5		0.7	1.5		0.7	1.5		MHz	
Slew Rate	$S_R$	1.1	1.9		1.1	1.9		1.1	1.9		V/ $\mu s$	$A_V = +1$ $R_L = 10K\Omega$
Rise time	$t_r$		0.2			0.2			0.2		$\mu s$	$R_L = 10K\Omega$
Overshoot Factor			10			10			10		%	$R_L = 10K\Omega$ $C_L = 100pF$

## OPERATING ELECTRICAL CHARACTERISTICS (cont'd)

$T_A = 25^\circ\text{C}$   $V_S = \pm 2.5\text{V}$  unless otherwise specified

Parameter	Symbol	2702A			2702B			2702			Unit	Test Conditions
		Min	Typ	Max	Min	Typ	Max	Min	Typ	Max		
Maximum Load Capacitance	$C_L$		400 4000			400 4000			400 4000		pF pF	Gain = 1 Gain = 5
Input Noise Voltage	$e_n$		26			26			26		nV/ $\sqrt{\text{Hz}}$	f = 1KHz
Input Current Noise	$i_n$		0.6			0.6			0.6		fA/ $\sqrt{\text{Hz}}$	f = 10Hz
Settling Time	$t_s$		8.0 3.0			8.0 3.0			8.0 3.0		$\mu\text{s}$ $\mu\text{s}$	0.01% 0.1% $A_V = -1$ $R_L = 5\text{K}\Omega$ $C_L = 50\text{pF}$

$T_A = 25^\circ\text{C}$   $V_S = \pm 5.0\text{V}$  unless otherwise specified

Parameter	Symbol	2702A			2702B			2702			Unit	Test Conditions
		Min	Typ	Max	Min	Typ	Max	Min	Typ	Max		
Power Supply Rejection Ratio	PSRR		83			83			83		dB	$R_S \leq 100\text{K}\Omega$
Common Mode Rejection Ratio	CMRR		83			83			83		dB	$R_S \leq 100\text{K}\Omega$
Large Signal Voltage Gain	$A_V$		250			250			250		V/mV	$R_L = 10\text{K}\Omega$
Output Voltage Range	$V_{O\text{ low}}$ $V_{O\text{ high}}$	4.8	-4.90 4.93	-4.8	4.8	-4.90 4.93	-4.8	4.8	-4.90 4.93	-4.8	V	$R_L = 10\text{K}\Omega$
Bandwidth	$B_W$		1.7			1.7			1.7		MHz	
Slew Rate	$S_R$		2.8			2.8			2.8		V/ $\mu\text{s}$	$A_V = +1$ $C_L = 50\text{pF}$

$V_S = +5.0\text{V}$   $-55^\circ\text{C} \leq T_A \leq +125^\circ\text{C}$  unless otherwise specified

Parameter	Symbol	2702ADA			2702BDA			2702DA			Unit	Test Conditions
		Min	Typ	Max	Min	Typ	Max	Min	Typ	Max		
Input Offset Voltage	$V_{OS}$			2.0			4.0			7.0	mV	$R_S \leq 100\text{K}\Omega$
Input Offset Current	$I_{OS}$			8.0			8.0			8.0	nA	
Input Bias Current	$I_B$			10.0			10.0			10.0	nA	
Power Supply Rejection Ratio	PSRR	60	75		60	75		60	75		dB	$R_S \leq 100\text{K}\Omega$
Common Mode Rejection Ratio	CMRR	60	83		60	83		60	83		dB	$R_S \leq 100\text{K}\Omega$
Large Signal Voltage Gain	$A_V$	10	25		10	25		7	25		V/mV	$R_L \leq 10\text{K}\Omega$
Output Voltage Range	$V_{O\text{ low}}$ $V_{O\text{ high}}$	4.8	0.1 4.9	0.2	4.8	0.1 4.9	0.2	4.8	0.1 4.9	0.2	V	$R_L \leq 10\text{K}\Omega$

## Design & Operating Notes:

- The ALD2702A/ALD2702B/ALD2702 CMOS operational amplifier uses a 3 gain stage architecture and an improved frequency compensation scheme to achieve large voltage gain, high output driving capability, and better frequency stability. The ALD2702A/ALD2702B/ALD2702 is internally compensated for unity gain stability using a novel scheme. This design produces a clean single pole roll off in the gain characteristics while providing for more than 70 degrees of phase margin at the unity gain frequency. A unity gain buffer using the ALD2702A/ALD2702B/ALD2702 will typically drive 400pF of external load capacitance without stability problems. In the inverting unity gain configuration, it can drive up to 800pF of load capacitance. Compared to other CMOS operational amplifiers, the ALD2702A/ALD2702B/ALD2702 has shown itself to be more resistant to parasitic oscillations.
- The ALD2702A/ALD2702B/ALD2702 has complementary p-channel and n-channel input differential stages connected in parallel to accomplish rail-to-rail input common mode voltage range. With the common mode input voltage close to the power supplies, one of the two differential stages is switched off internally. To maintain compatibility with other operational amplifiers, this switching point has been selected to be about 1.5V above the negative supply voltage. As offset voltage trimming on the ALD2702A/ALD2702B/ALD2702 is made when the input voltage is symmetrical to the supply voltages, this internal switching does not affect a large variety of applications such as an inverting amplifier or non-inverting amplifier with a gain greater than 2.5 (5V operation), where the common mode voltage does not make excursions below this switching point.
- The input bias and offset currents are essentially input protection diode reverse bias leakage currents, and are typically less than 1pA at room temperature. This low input bias current assures that the analog signal from the source will not be distorted by input bias currents. For applications where source impedance is very high, it may be necessary to limit noise and hum pickup through proper shielding.
- The output stage consists of class AB complementary output drivers, capable of driving a low resistance load. The output voltage swing is limited by the drain to source on-resistance of the output transistors as determined by the bias circuitry, and the value of the load resistor. When connected in the voltage follower configuration, the oscillation resistant feature, combined with the rail to rail input and output feature, makes the ALD2702A/ALD2702B/ALD2702 an effective analog signal buffer for medium to high source impedance sensors, transducers, and other circuit networks.
- The ALD2702A/ALD2702B/ALD2702 operational amplifier has been designed with static discharge protection. Internally, the design has been carefully implemented to minimize latch up. However, care must be exercised when handling the device to avoid strong static fields. In using the operational amplifier, the user is advised to power up the circuit before, or simultaneously with, any input voltages applied and to limit input voltages to not exceed 0.3V of the power supply voltage levels. Alternatively, a 100K $\Omega$  or higher value resistor at the input terminals will limit input currents to acceptable levels while causing very small or negligible accuracy effects.

## TYPICAL PERFORMANCE CHARACTERISTICS

**COMMON MODE INPUT VOLTAGE RANGE AS A FUNCTION OF SUPPLY VOLTAGE**

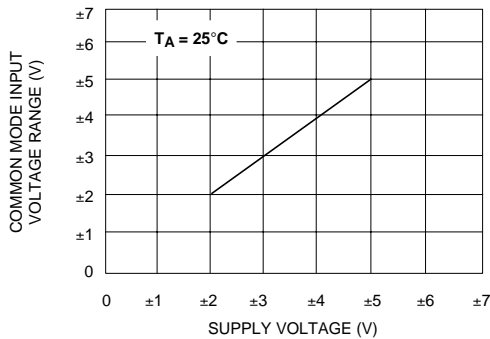

**OPEN LOOP VOLTAGE GAIN AS A FUNCTION OF SUPPLY VOLTAGE AND TEMPERATURE**

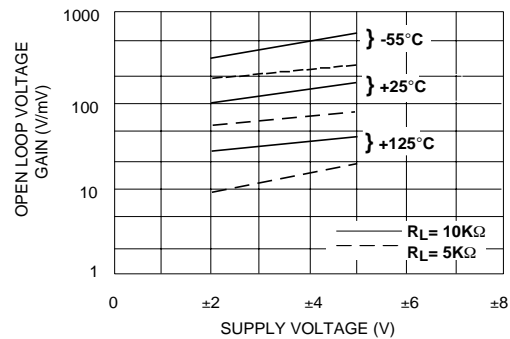

**INPUT BIAS CURRENT AS A FUNCTION OF AMBIENT TEMPERATURE**

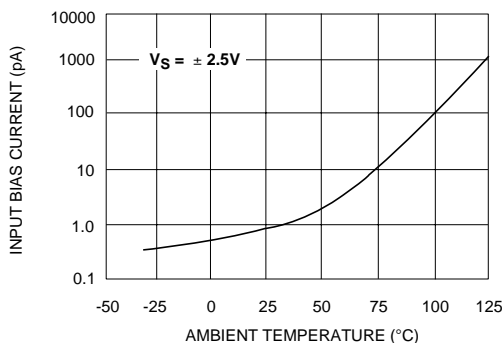

**SUPPLY CURRENT AS A FUNCTION OF SUPPLY VOLTAGE**

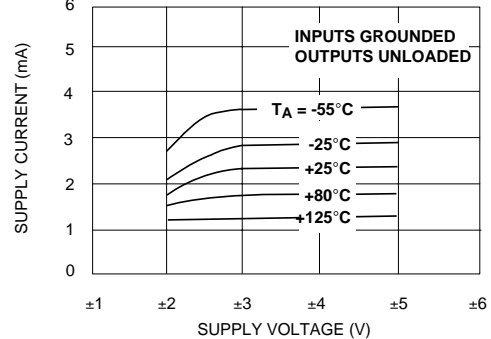

## TYPICAL PERFORMANCE CHARACTERISTICS (cont'd)

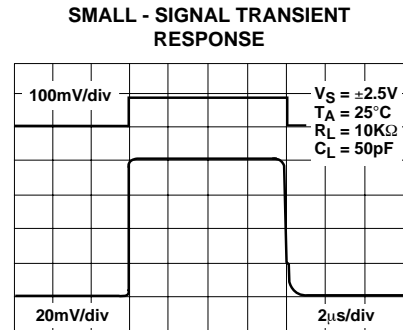
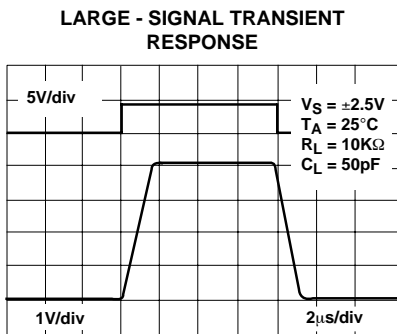
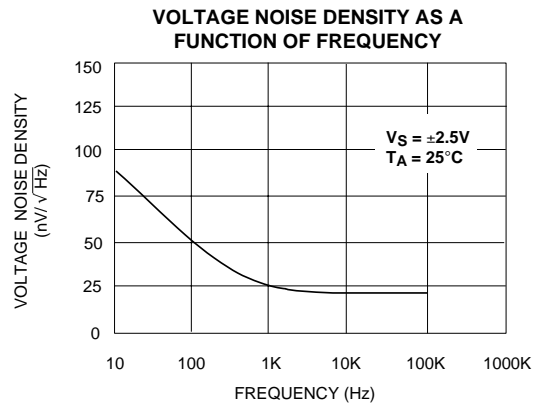
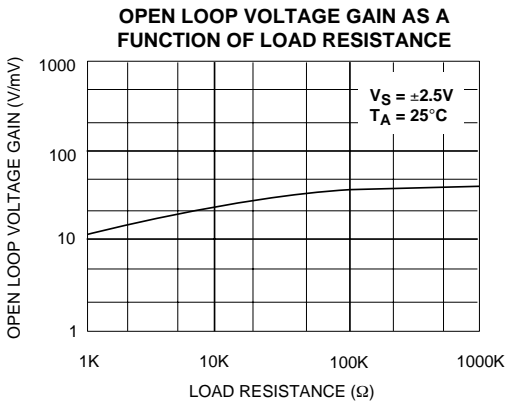
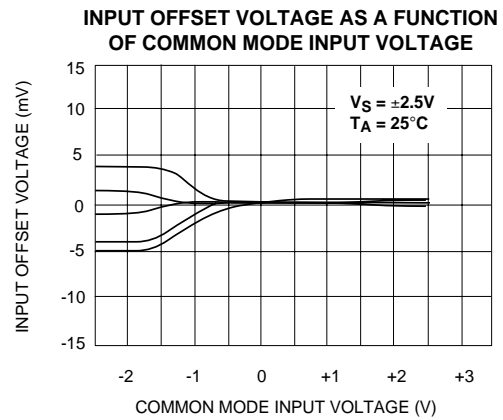
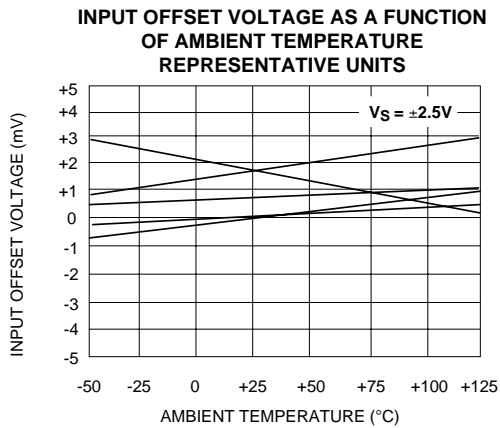
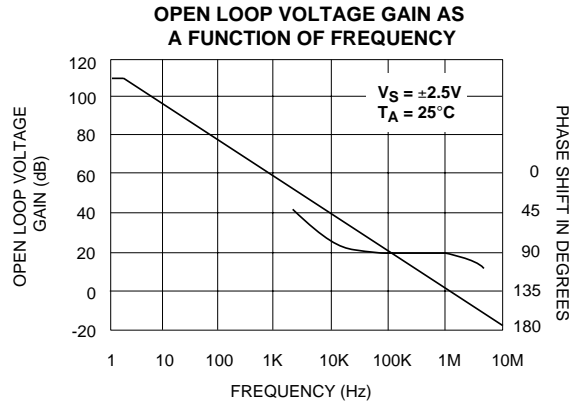
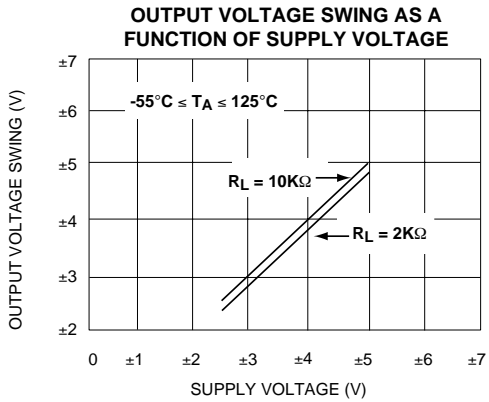

## TYPICAL APPLICATIONS

### RAIL-TO-RAIL VOLTAGE FOLLOWER/BUFFER

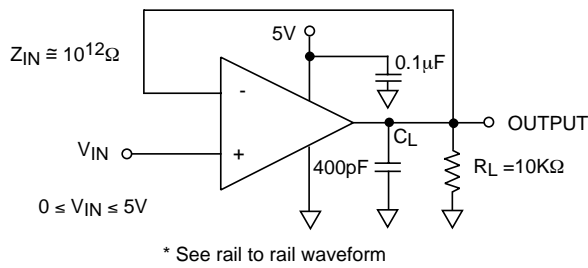

### RAIL-TO-RAIL WAVEFORM

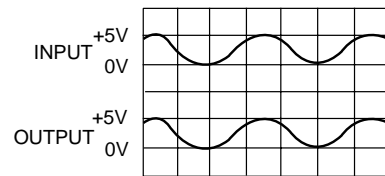

**Performance waveforms.**  
Upper trace is the output of a Wien Bridge Oscillator. Lower trace is the output of Rail-to-Rail voltage follower.

### LOW OFFSET SUMMING AMPLIFIER

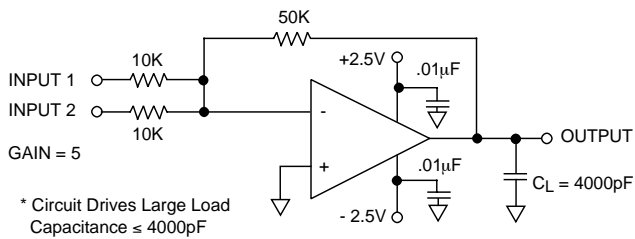

### PHOTO DETECTOR CURRENT TO VOLTAGE CONVERTER

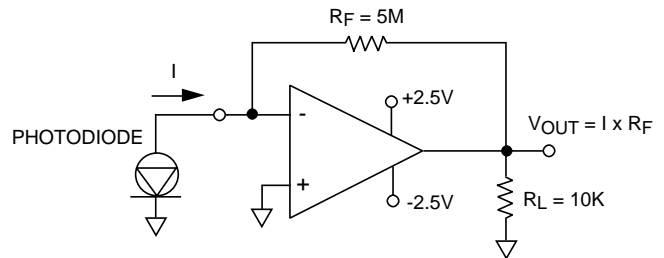

### WIEN BRIDGE OSCILLATOR (RAIL-TO-RAIL) SINE WAVE GENERATOR

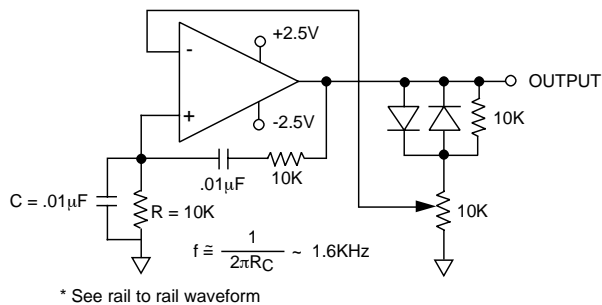

### RAIL-TO-RAIL VOLTAGE COMPARATOR

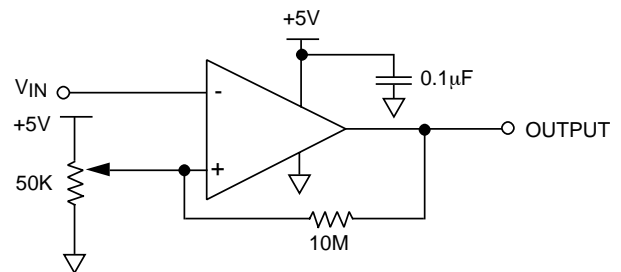

# SOIC-8 PACKAGE DRAWING

## 8 Pin Plastic SOIC Package

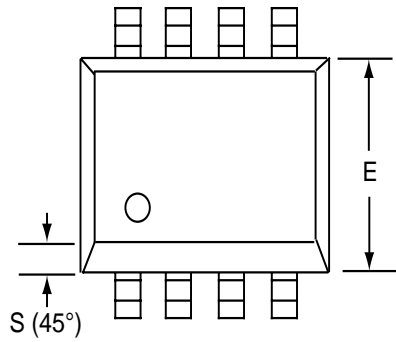

Dim	Millimeters		Inches	
	Min	Max	Min	Max
A	1.35	1.75	0.053	0.069
A <sub>1</sub>	0.10	0.25	0.004	0.010
b	0.35	0.45	0.014	0.018
C	0.18	0.25	0.007	0.010
D-8	4.69	5.00	0.185	0.196
E	3.50	4.05	0.140	0.160
e	1.27 BSC		0.050 BSC	
H	5.70	6.30	0.224	0.248
L	0.60	0.937	0.024	0.037
∅	0°	8°	0°	8°
S	0.25	0.50	0.010	0.020

# PDIP-8 PACKAGE DRAWING

## 8 Pin Plastic DIP Package

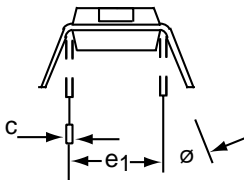
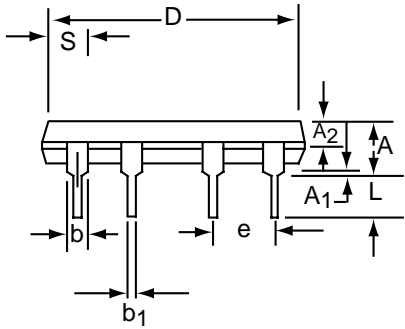

Dim	Millimeters		Inches	
	Min	Max	Min	Max
A	3.81	5.08	0.105	0.200
A <sub>1</sub>	0.38	1.27	0.015	0.050
A <sub>2</sub>	1.27	2.03	0.050	0.080
b	0.89	1.65	0.035	0.065
b <sub>1</sub>	0.38	0.51	0.015	0.020
c	0.20	0.30	0.008	0.012
D-8	9.40	11.68	0.370	0.460
E	5.59	7.11	0.220	0.280
E <sub>1</sub>	7.62	8.26	0.300	0.325
e	2.29	2.79	0.090	0.110
e <sub>1</sub>	7.37	7.87	0.290	0.310
L	2.79	3.81	0.110	0.150
S-8	1.02	2.03	0.040	0.080
∅	0°	15°	0°	15°