



Alpha 14

5G/4G High Gain Adhesive Patch Antenna



Key Features

- Supports 5G NR / 4G LTE / 3G UMTS
- Supports LTE Cat M, LTE Cat NB and NR Cat NB Bands
- Adhesive Mount
- Small footprint
- Compact 3 mm flat blade form factor
- Achieves gain of 5-8 dBi in the 1800-2100 MHz range

General Description

The Alpha 14 is one of the most compact adhesive antennas, with a slim low profile design. Typically used for applications such as smart energy meters or telemetry equipment, the Alpha 14 achieves a high gain in the 1.8-2.1 GHz frequency range despite its small size. Supplied with a 3M adhesive base.

The Alpha 14 is tuned to certain bands of UMTS (3G), LTE (4G) and NR (5G), allowing for worldwide use.

The Alpha 14 is supplied with different length cables and SMAM/FMEF connectors. Alternative cable lengths and connectors can be specified for volume orders.

Additional Considerations

- Low profile design makes it ideal for covert applications
- Intended for indoor use

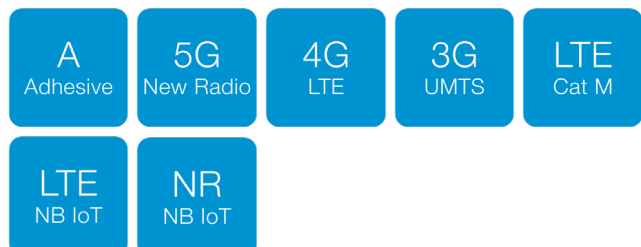



Alpha 14

5G/4G High Gain Adhesive Patch Antenna

Electrical Specifications

Impedance:	50 Ohm
Polarization:	Linear
Max Input Power:	10 W
Ground plane independent:	No

Environmental Specifications

Operating Temperature range:	-30 to +75 °C
Storage Temperature range:	-40 to +85 °C

Mechanical Specifications

Dimensions:	39.9 x 33.5 x 5.5 mm
Weight:	42 g
Connector:	SMA Male
Mounting method:	Adhesive Pad
Housing materials:	ABS

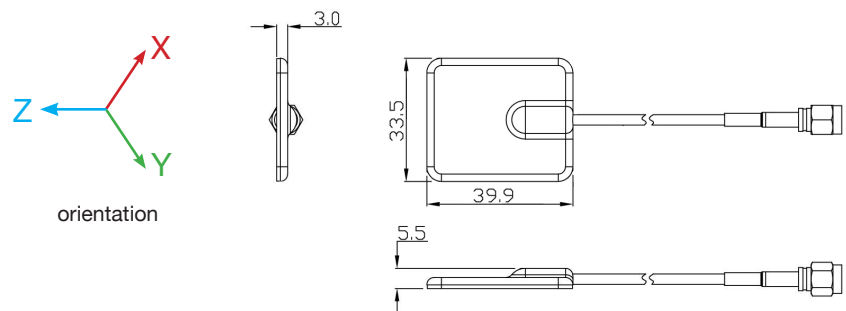



Spectrum Coverage

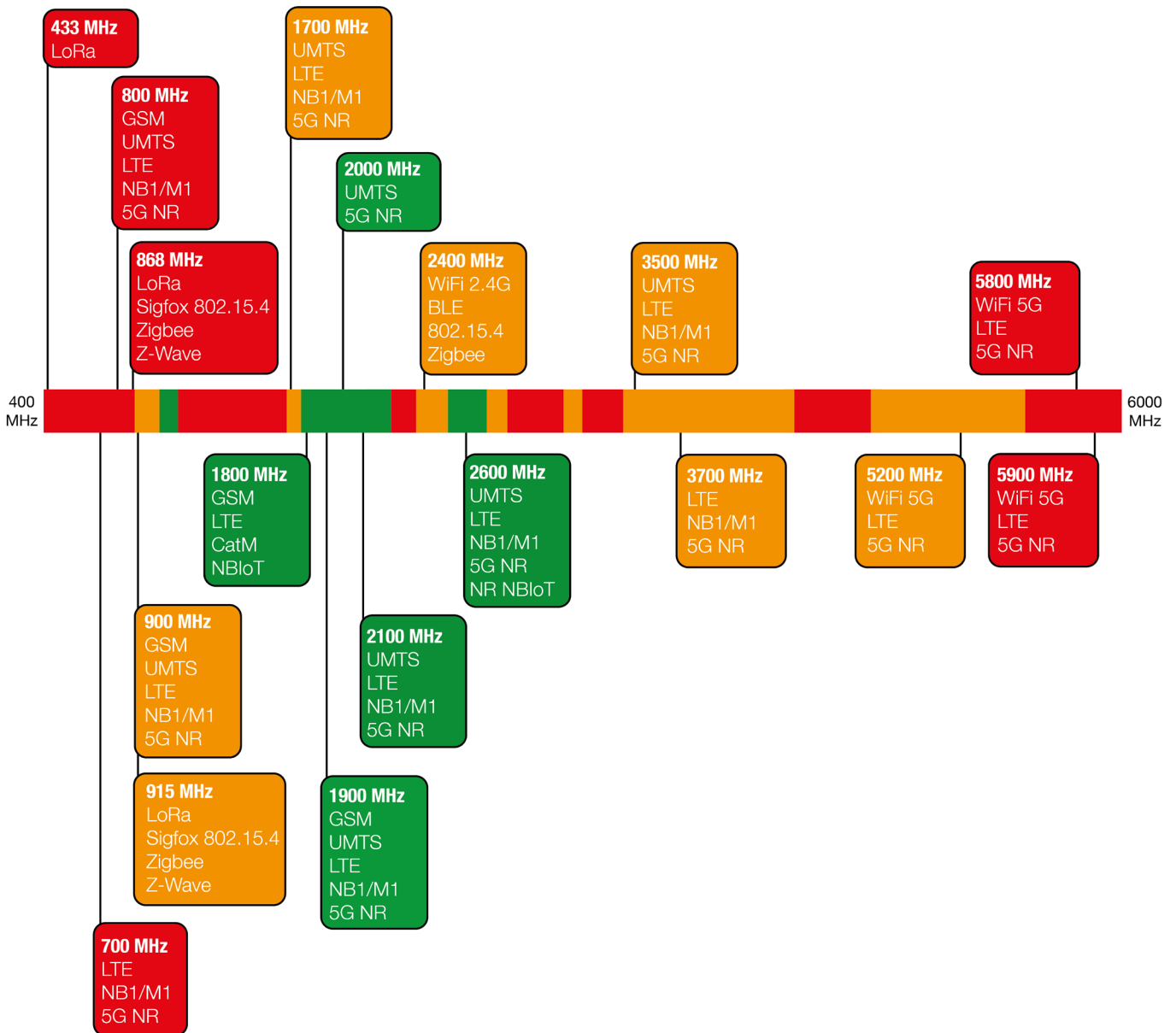

● Suitable band

● Adequate band in good signal conditions

● Likely to be unsuitable



Alpha 14

5G/4G High Gain Adhesive Patch Antenna

Usable Cellular Frequency Support (410 MHz – 1900 MHz)

	410	450	600	700	800	850	900	1500	1600	1700	1800	1900
GSM Bands:												●
UMTS Bands:										●		●
LTE Bands:										●		●
LTE Cat M Bands:												●
LTE Cat NB Bands:												●
5G NR Bands:												●
NR Cat NB Bands:												●

Usable Cellular Frequency Support (2000 MHz – 5900 MHz)

	2000	2100	2300	2400	2500	2600	3300	3500	3700	4700	5200	5900
GSM Bands:												
UMTS Bands:		●				●						
LTE Bands:	●	●		●	●	●						
LTE Cat M Bands:		●			●	●						
LTE Cat NB Bands:		●			●	●						
5G NR Bands:	●	●		●	●	●						
NR Cat NB Bands:		●			●	●						



Alpha 14

5G/4G High Gain Adhesive Patch Antenna

Peak Gain vs. Frequency

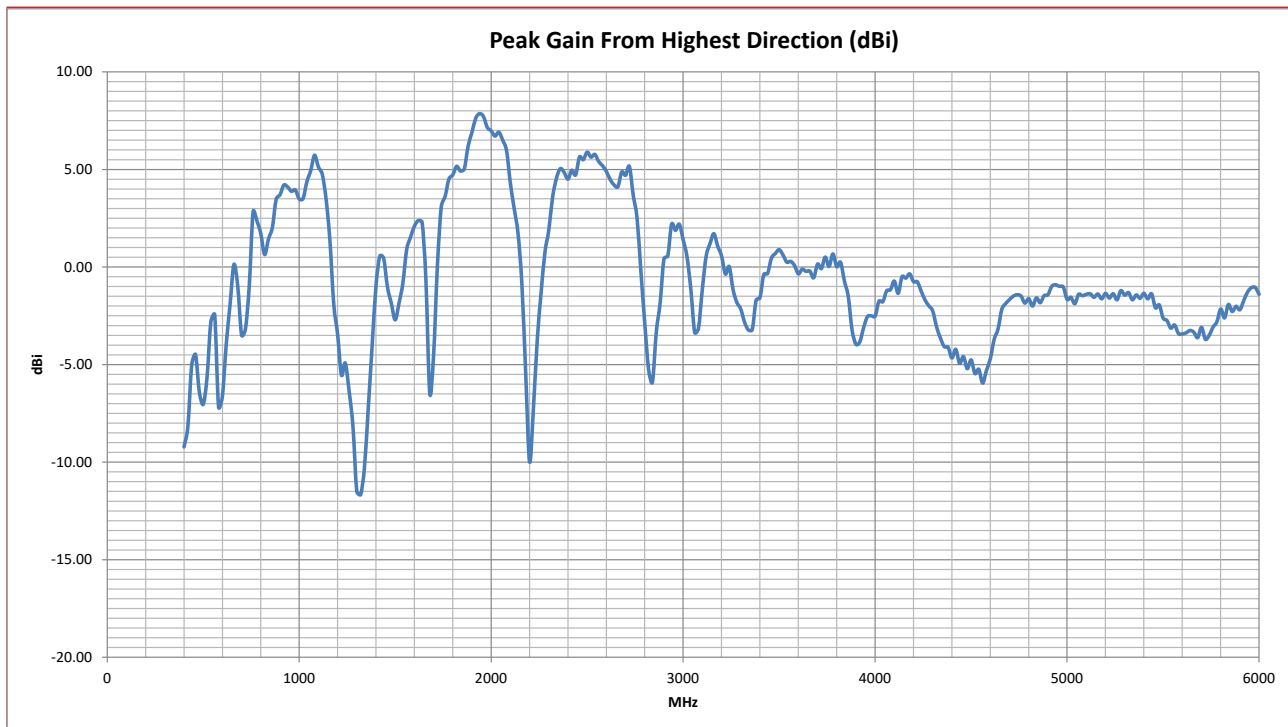

Return Loss

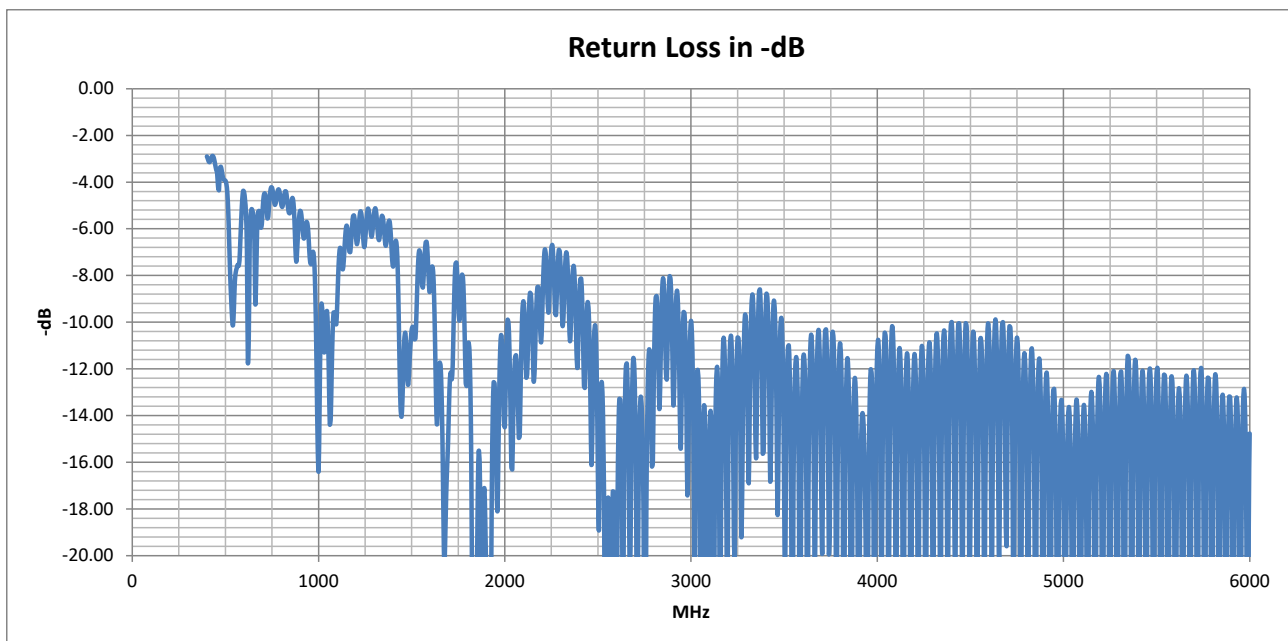



Alpha 14

5G/4G High Gain Adhesive Patch Antenna

VSWR

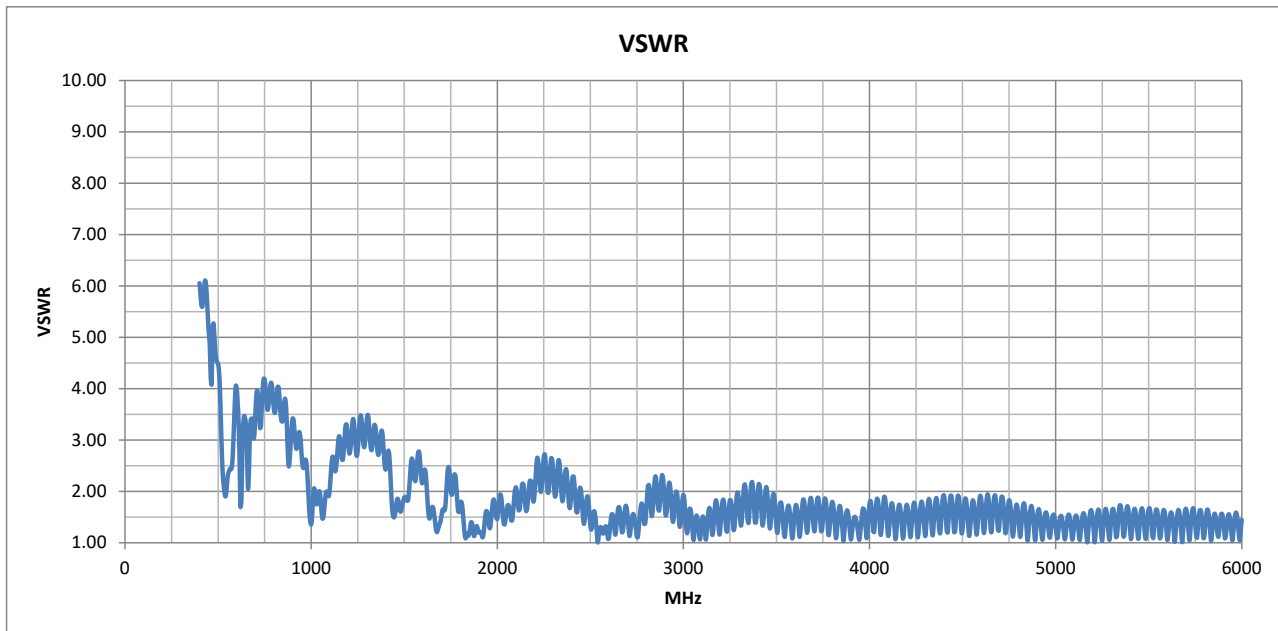

Radiation Efficiency

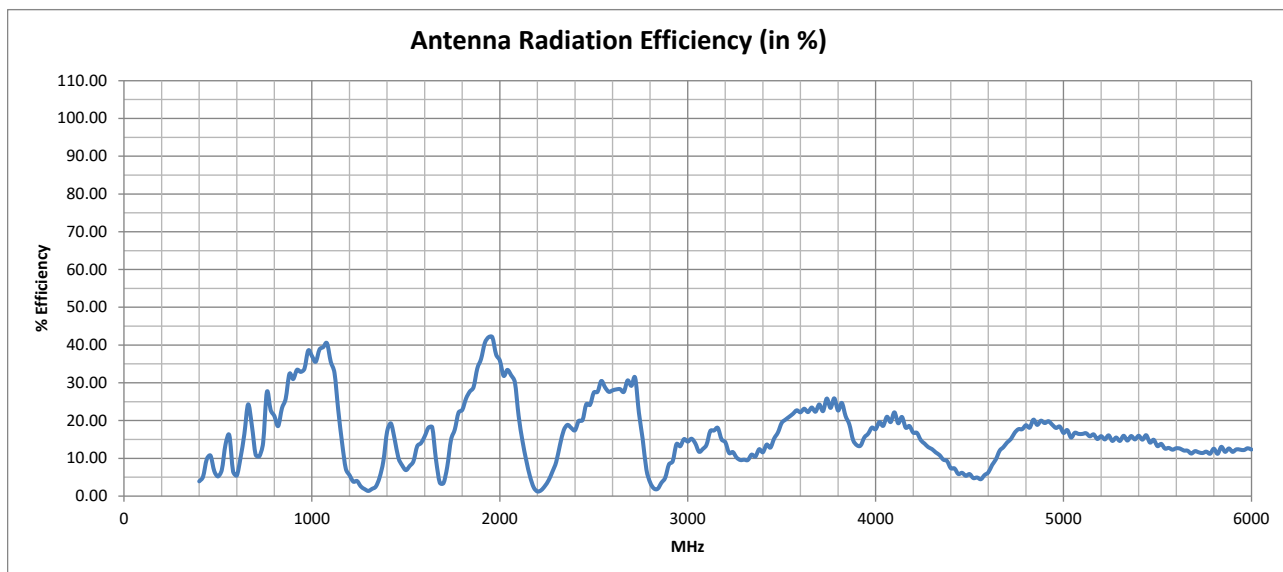



Cellular Standards Band Support

GSM (2G) Band	UMTS (3G) Band	E-UTRA (4G) Band	Cat M E-UTRA Band	Cat NB E-UTRA Band	NR (5G) Band	Cat NB NR (5G) Band	Uplink	Downlink	Average Upload Efficiency (%)	Average Download Efficiency (%)	Maximum Upload VSWR	Maximum Download VSWR	Use Indicator
	1	1	1	1	n1	n1	1920 - 1980 MHz	2110 - 2170 MHz	41.05	9.98	1.84	2.15	●
PCS-1900	2	2	2	2	n2	n2	1850 - 1910 MHz	1930 - 1990 MHz	33.11	40.41	1.40	1.84	●
DCS-1800	3	3	3	3	n3	n3	1710 - 1785 MHz	1805 - 1880 MHz	15.00	27.96	2.47	1.80	●
	4	4	4	4			1710 - 1755 MHz	2110 - 2155 MHz	11.82	11.66	2.47	2.15	●
GSM-850	5	5	5	5	n5	n5	824 - 849 MHz	869 - 894 MHz	22.23	31.28	4.03	3.30	●
	6						830 - 840 MHz	875 - 885 MHz	22.05	31.86	3.80	2.70	●
	7	7	7	7	n7	n7	2500 - 2570 MHz	2620 - 2690 MHz	28.69	28.71	1.62	1.72	●
E-GSM-900	8	8	8	8	n8	n8	880 - 915 MHz	925 - 960 MHz	31.77	33.21	3.42	3.16	●
	9	9					1749.9 - 1784.9 MHz	1844.9 - 1879.9 MHz	19.31	30.06	2.33	1.40	●
	10	10					1710 - 1770 MHz	2110 - 2170 MHz	13.42	9.98	2.47	2.15	●
	11	11	11	11			1427.9 - 1447.9 MHz	1475.9 - 1495.9 MHz	15.44	7.76	2.14	1.83	●
	12	12	12	12	n12	n12	699 - 716 MHz	729 - 746 MHz	10.81	14.17	3.97	4.20	●
	13	13	13	13	n13	n13	777 - 787 MHz	746 - 756 MHz	22.71	21.49	4.12	4.19	●
	14	14	14	14	n14		788 - 798 MHz	758 - 768 MHz	21.75	26.64	4.06	3.83	●
		17		17			704 - 716 MHz	734 - 746 MHz	10.74	14.84	3.97	4.20	●
		18	18	18	n18	n18	815 - 830 MHz	860 - 875 MHz	19.43	28.24	4.04	3.81	●
	19	19	19	19			830 - 845 MHz	875 - 890 MHz	22.55	31.85	3.80	2.96	●
	20	20	20	20	n20	n20	832 - 862 MHz	791 - 821 MHz	24.01	20.33	3.81	4.04	●
	21	21	21	21			1447.9 - 1462.9 MHz	1495.9 - 1510.9 MHz	11.28	7.11	1.84	1.90	●
	22	22					3410 - 3490 MHz	3510 - 3590 MHz	14.64	21.38	2.11	1.79	●
		24	24	24	n24		1626.5 - 1660.5 MHz	1525 - 1559 MHz	15.54	10.04	1.74	2.64	●
	25	25	25	25	n25	n25	1850 - 1915 MHz	1930 - 1995 MHz	33.56	40.11	1.40	1.84	●
	26	26	26	26	n26		814 - 849 MHz	859 - 894 MHz	21.30	30.09	4.04	3.81	●
		27	27				807 - 824 MHz	852 - 869 MHz	19.31	26.31	4.04	3.81	●
		28	28	28	n28	n28	703 - 748 MHz	758 - 803 MHz	12.50	23.56	4.20	4.12	●

● Suitable band

● Adequate band in good signal conditions

● Likely to be unsuitable



Cellular Standards Band Support

GSM (2G) Band	UMTS (3G) Band	E-UTRA (4G) Band	Cat M E-UTRA Band	Cat NB E-UTRA Band	NR (5G) Band	Cat NB NR (5G) Band	Uplink	Downlink	Average Upload Efficiency (%)	Average Download Efficiency (%)	Maximum Upload VSWR	Maximum Download VSWR	Use Indicator
		28A					703 - 733 MHz	758 - 788 MHz	11.13	24.57	3.97	4.12	●
		29			n29		N/A	717 - 728 MHz	N/A	11.05	N/A	3.74	●
		30			n30		2305 - 2315 MHz	2350 - 2360 MHz	11.29	18.48	2.09	2.16	●
		31	31	31			452.5 - 457.5 MHz	462.5 - 467.5 MHz	10.45	9.67	4.97	4.65	●
	32	32					N/A	1452 - 1496 MHz	N/A	8.92	N/A	1.86	●
		33					1900 - 1920 MHz	1900 - 1920 MHz	38.43	38.43	1.21	1.21	●
		34			n34		2010 - 2025 MHz	2010 - 2025 MHz	32.59	32.59	1.94	1.94	●
		35					1850 - 1910 MHz	1850 - 1910 MHz	33.11	33.11	1.40	1.40	●
		36					1930 - 1990 MHz	1930 - 1990 MHz	40.41	40.41	1.84	1.84	●
		37					1910 - 1930 MHz	1910 - 1930 MHz	40.21	40.21	1.32	1.32	●
		38			n38		2570 - 2620 MHz	2570 - 2620 MHz	27.95	27.95	1.55	1.55	●
		39	39		n39		1880 - 1920 MHz	1880 - 1920 MHz	36.74	36.74	1.32	1.32	●
		40	40		n40		2300 - 2400 MHz	2300 - 2400 MHz	16.21	16.21	2.61	2.61	●
		41	41	41	n41	n41	2496 - 2690 MHz	2496 - 2690 MHz	28.47	28.47	1.72	1.72	●
		42	42	42			3400 - 3600 MHz	3400 - 3600 MHz	18.04	18.04	2.14	2.14	●
		43	43	43			3600 - 3800 MHz	3600 - 3800 MHz	23.53	23.53	1.88	1.88	●
		44					703 - 803 MHz	703 - 803 MHz	18.51	18.51	4.20	4.20	●
		45					1447 - 1467 MHz	1447 - 1467 MHz	11.02	11.02	1.86	1.86	●
		46			n46		5150 - 5925 MHz	5150 - 5925 MHz	13.56	13.56	1.73	1.73	●
		47			n47		5855 - 5925 MHz	5855 - 5925 MHz	12.10	12.10	1.57	1.57	●
		48			n48		3550 - 3700 MHz	3550 - 3700 MHz	22.64	22.64	1.88	1.88	●
		49					3550 - 3700 MHz	3550 - 3700 MHz	22.64	22.64	1.88	1.88	●
		50			n50		1432 - 1517 MHz	1432 - 1517 MHz	9.82	9.82	1.90	1.90	●
		51			n51		1427 - 1432 MHz	1427 - 1432 MHz	17.25	17.25	2.22	2.22	●
		52					3300 - 3400 MHz	3300 - 3400 MHz	10.79	10.79	2.18	2.18	●

● Suitable band

● Adequate band in good signal conditions

● Likely to be unsuitable



Cellular Standards Band Support

GSM (2G) Band	UMTS (3G) Band	E-UTRA (4G) Band	Cat M E-UTRA Band	Cat NB E-UTRA Band	NR (5G) Band	Cat NB NR (5G) Band	Uplink	Downlink	Average Upload Efficiency (%)	Average Download Efficiency (%)	Maximum Upload VSWR	Maximum Download VSWR	Use Indicator
		53			n53		2483.5 - 2495 MHz	2483.5 - 2495 MHz	25.66	25.66	1.91	1.91	●
		65		65	n65	n65	1920 - 2010 MHz	2110 - 2200 MHz	39.40	7.38	1.84	2.21	●
		66	66	66	n66	n66	1710 - 1780 MHz	2110 - 2200 MHz	14.49	7.38	2.47	2.21	●
		67			n67		N/A	738 - 758 MHz	N/A	19.52	N/A	4.20	●
		68					698 - 728 MHz	753 - 783 MHz	10.92	24.92	3.97	4.09	●
		69					N/A	2570 - 2620 MHz	N/A	27.95	N/A	1.55	●
		70		70	n70	n70	1695 - 1710 MHz	1995 - 2020 MHz	4.15	34.31	1.66	1.94	●
		71	71	71	n71		663 - 698 MHz	617 - 652 MHz	18.06	14.85	3.42	3.47	●
		72	72	72			451 - 456 MHz	461 - 466 MHz	10.38	9.97	5.04	4.32	●
		73	73	73			450 - 455 MHz	460 - 465 MHz	10.33	10.18	5.08	4.22	●
		74	74	74	n74		1427 - 1470 MHz	1475 - 1518 MHz	13.05	7.53	2.22	1.90	●
		75			n75		N/A	1432 - 1517 MHz	N/A	9.82	N/A	1.90	●
		76			n76		N/A	1427 - 1432 MHz	N/A	17.25	N/A	2.22	●
					n77		3300 - 4200 MHz	3300 - 4200 MHz	18.70	18.70	2.18	2.18	●
					n78		3300 - 3800 MHz	3300 - 3800 MHz	18.79	18.79	2.18	2.18	●
					n79		4400 - 5000 MHz	4400 - 5000 MHz	12.77	12.77	1.94	1.94	●
					n80		1710 - 1785 MHz	N/A	15.00	N/A	2.47	N/A	●
					n81		880 - 915 MHz	N/A	31.77	N/A	3.42	N/A	●
					n82		832 - 862 MHz	N/A	24.01	N/A	3.81	N/A	●
					n83		703 - 748 MHz	N/A	12.50	N/A	4.20	N/A	●
					n84		1920 - 1980 MHz	N/A	41.05	N/A	1.84	N/A	●
		85	85	85	n85		698 - 716 MHz	728 - 746 MHz	10.85	14.06	3.97	4.20	●
					n86		1710 - 1780 MHz	N/A	14.49	N/A	2.47	N/A	●
		87	87	87			410 - 415 MHz	420 - 425 MHz	4.62	5.65	5.63	5.98	●
		88	88	88			412 - 417 MHz	422 - 427 MHz	4.74	6.12	5.67	6.03	●

● Suitable band

● Adequate band in good signal conditions

● Likely to be unsuitable



Cellular Standards Band Support

GSM (2G) Band	UMTS (3G) Band	E-UTRA (4G) Band	Cat M E-UTRA Band	Cat NB E-UTRA Band	NR (5G) Band	Cat NB NR (5G) Band	Uplink	Downlink	Average Upload Efficiency (%)	Average Download Efficiency (%)	Maximum Upload VSWR	Maximum Download VSWR	Use Indicator
					n89		824 - 849 MHz	N/A	22.23	N/A	4.03	N/A	●
					n90	n90	2496 - 2690 MHz	2496 - 2690 MHz	28.47	28.47	1.72	1.72	●
					n91		832 - 862 MHz	1427 - 1432 MHz	24.01	17.25	3.81	2.22	●
					n92		832 - 862 MHz	1432 - 1517 MHz	24.01	9.82	3.81	1.90	●
					n93		880 - 915 MHz	1427 - 1432 MHz	31.77	17.25	3.42	2.22	●
					n94		880 - 915 MHz	1432 - 1517 MHz	31.77	9.82	3.42	1.90	●
					n95		2010 - 2025 MHz	N/A	32.59	N/A	1.94	N/A	●
					n97		2300 - 2400 MHz	N/A	16.21	N/A	2.61	N/A	●
					n98		1880 - 1920 MHz	N/A	36.74	N/A	1.32	N/A	●
					n99		1626.5 - 1660.5 MHz	N/A	15.54	N/A	1.74	N/A	●
					n101		1900 - 1910 MHz	1900 - 1910 MHz	37.37	37.37	1.21	1.21	●
				103			787 - 788 MHz	757 - 758 MHz	22.20	25.86	4.08	3.88	●

● Suitable band

● Adequate band in good signal conditions

● Likely to be unsuitable

NOTE: For each frequency band, Siretta provides a traffic light indication to show the suitability of the antenna for use at that frequency band. Determination of exactly what makes an antenna good or bad at any frequency is subjective.

The view presented is that of Siretta's engineering team having taken into account the efficiency and VSWR measurements. The end user is advised to use their own criteria and/or testing to confirm suitability.



ISM Standards Frequency Support

Application	Frequency Range	Efficiency (%)	Maximum VSWR	Peak Gain from highest direction (dBi)	Use Indicator
ISM 433 MHz	433.05 - 434.79 MHz	8.31	6.06	-5.8542	●
IMT 868 MHz	863 - 870 MHz	27.91	3.71	2.74	●
ISM 915 MHz	902 - 928 MHz	32.62	3.41	4.2	●
ISM 2.4 GHz	2400 - 2500 MHz	22.18	2.29	5.89	●
WiFi 2.4G	2401 - 2483 MHz	21.44	2.29	5.64	●
WiFi 2.4G (USA)	2401 - 2473 MHz	21.05	2.29	5.64	●
WiFi 2.4G (Japan)	2401 - 2495 MHz	21.97	2.29	5.7925	●
WiFi 5G (all channels)	5150 - 5990 MHz	13.46	1.73	-1.05	●
WiFi 5G (Ch 32-48)	5150 - 5250 MHz	15.62	1.65	-1.35	●
WiFi 5G (Ch 32-64)	5150 - 5330 MHz	15.42	1.66	-1.21	●
WiFi 5G (Ch 32-161)	5150 - 5815 MHz	13.79	1.73	-1.21	●
WiFi 5G (Ch 32-173)	5150 - 5875 MHz	13.65	1.73	-1.21	●
ISM 5.8 GHz	5725 - 5875 MHz	11.84	1.67	-1.92	●

● Suitable band

● Adequate band in good signal conditions

● Likely to be unsuitable

NOTE: For each frequency band, Siretta provides a traffic light indication to show the suitability of the antenna for use at that frequency band. Determination of exactly what makes an antenna good or bad at any frequency is subjective.

The view presented is that of Siretta's engineering team having taken into account the efficiency and VSWR measurements. The end user is advised to use their own criteria and/or testing to confirm suitability.



Alpha 14

5G/4G High Gain Adhesive Patch Antenna

2D Radiation Plots

1700 MHz XY

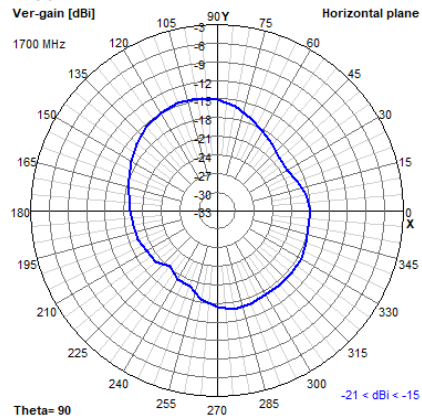

XZ

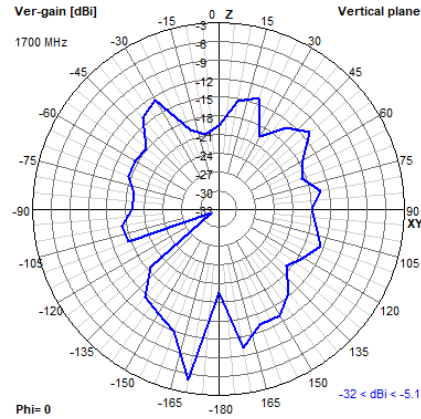

YZ

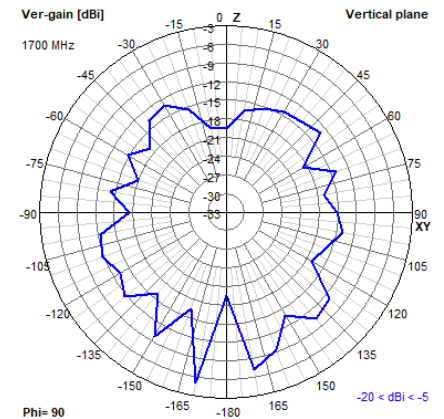

1900 MHz XY

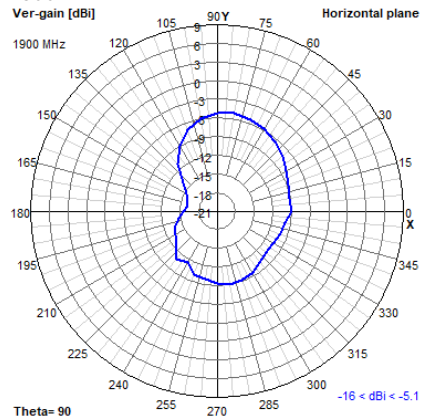

XZ

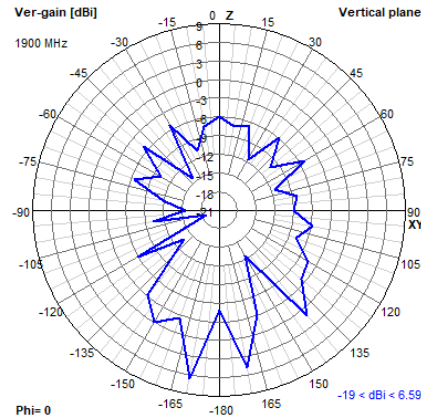

YZ

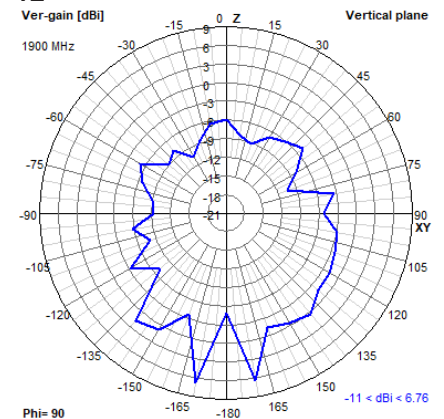

2000 MHz XY

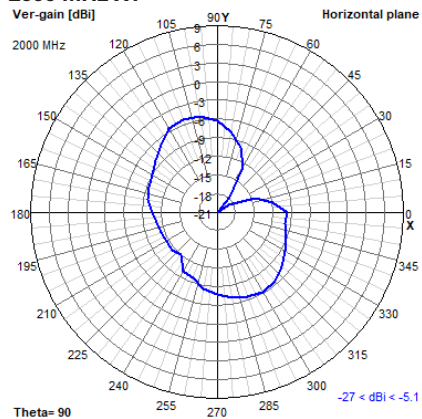

XZ

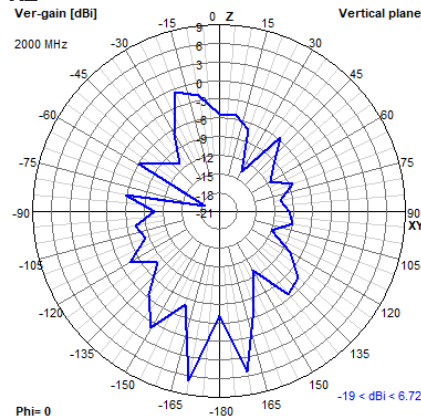

YZ

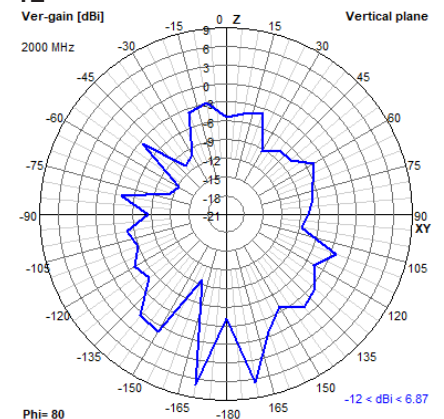



Alpha 14

5G/4G High Gain Adhesive Patch Antenna

2D Radiation Plots

2100 MHz XY

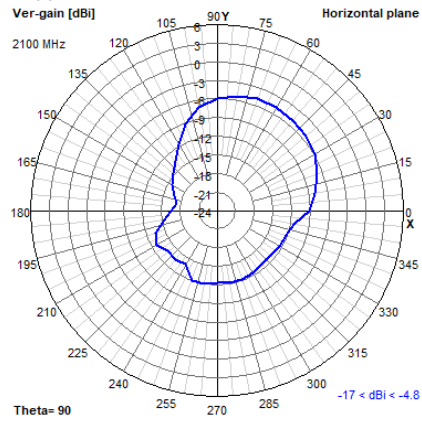

XZ

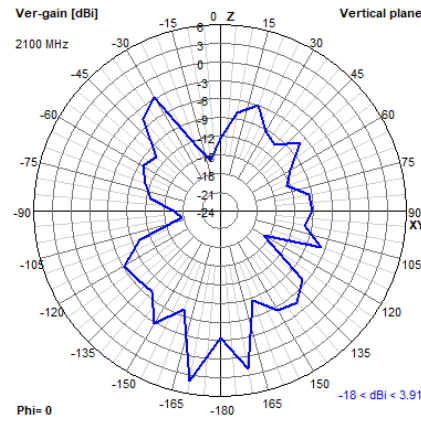

YZ

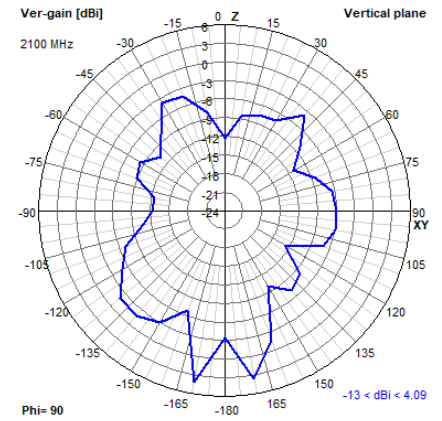

2400 MHz XY

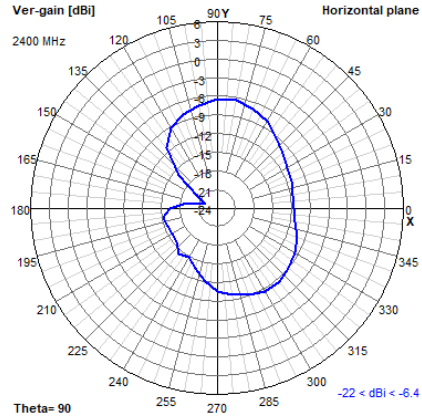

XZ

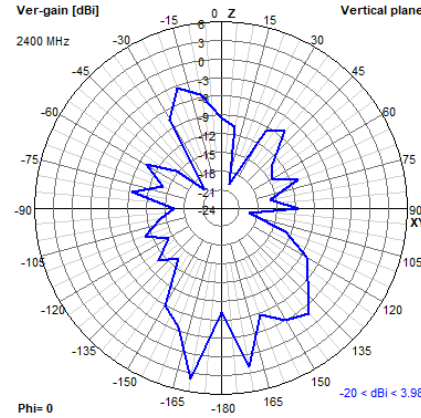

YZ

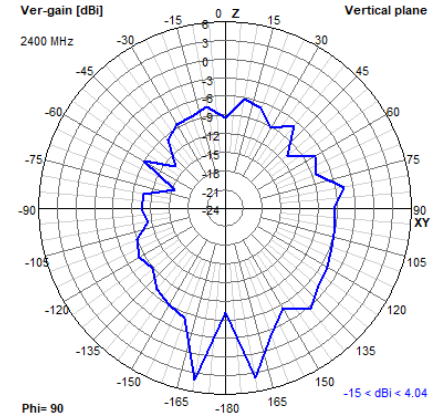

2500 MHz XY

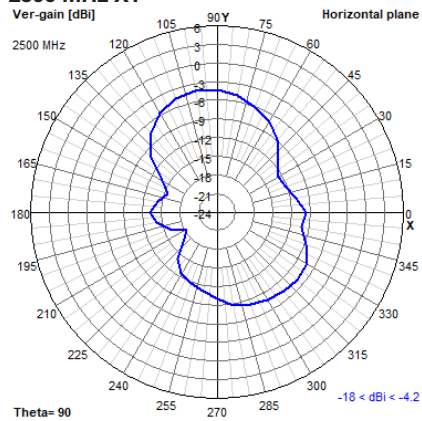

XZ

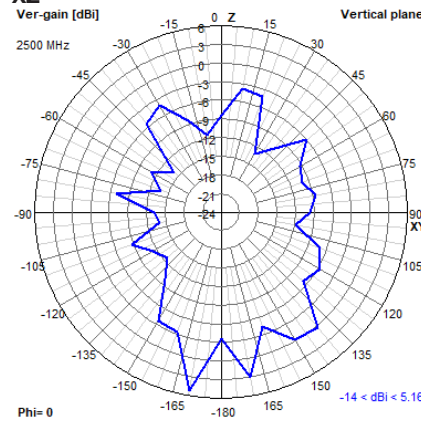

YZ

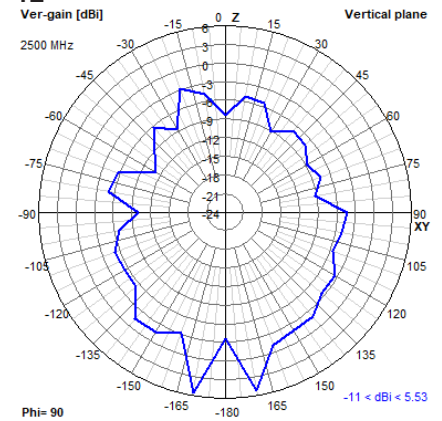



Alpha 14

5G/4G High Gain Adhesive Patch Antenna

2D Radiation Plots

2600 MHz XY

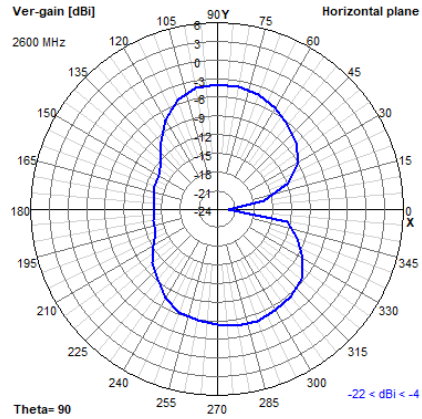

XZ

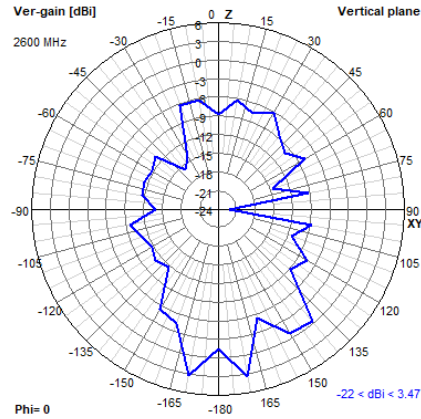

YZ

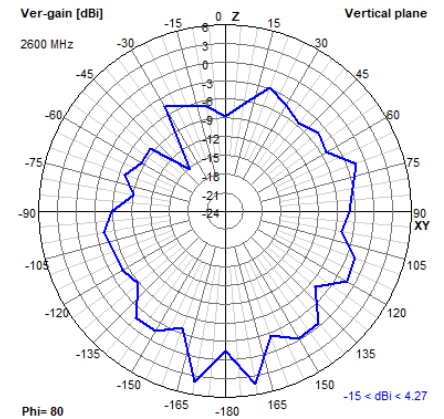



Alpha 14

5G/4G High Gain Adhesive Patch Antenna

3D Radiation Plots

1700 MHz

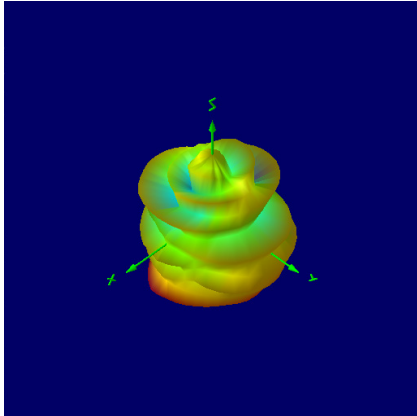

1900 MHz

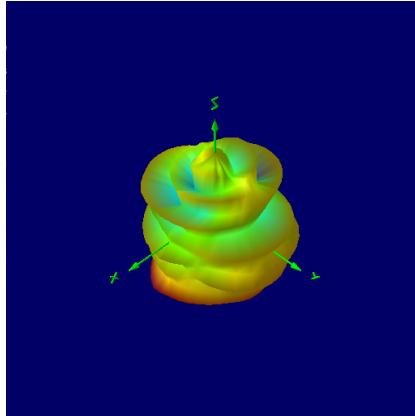

2000 MHz

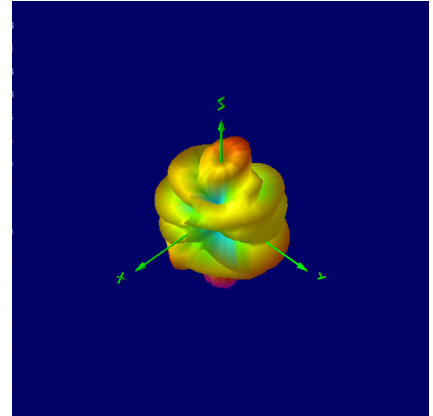

2100 MHz

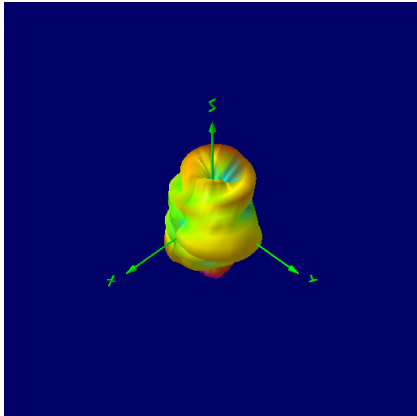

2400 MHz

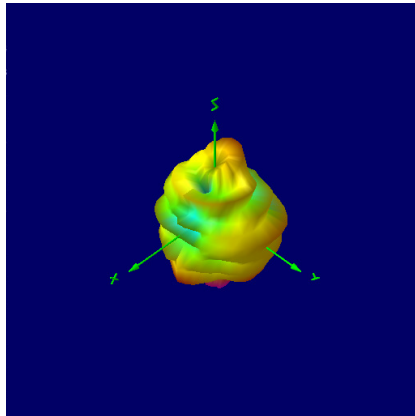

2500 MHz

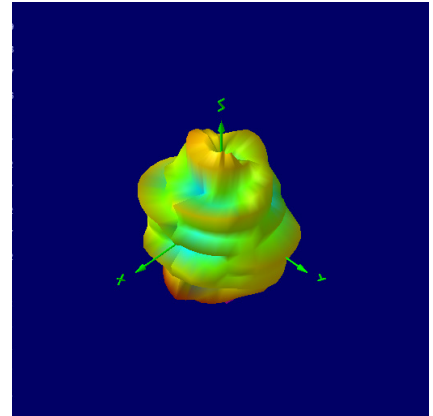

2600 MHz

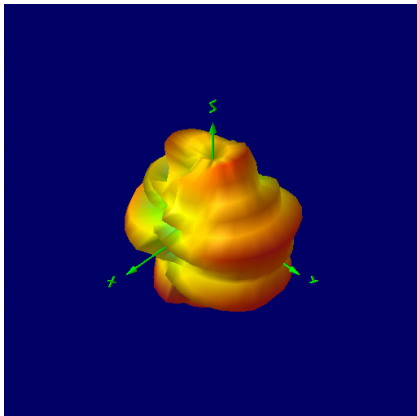

NOTE: All 3D radiation plots are shown with Theta = 45 and Phi = 45.