

## AMMSZ5221B-HF Thru. AMMSZ5267B-HF

RoHS Device  
Halogen Free



### Features

- Planar die construction.
- 500mW power dissipation.
- General purpose, medium current.
- Ideally suited for automated assembly processes.
- AEC-Q101 Qualified

### Mechanical data

- Case: Molded plastic, SOD-123

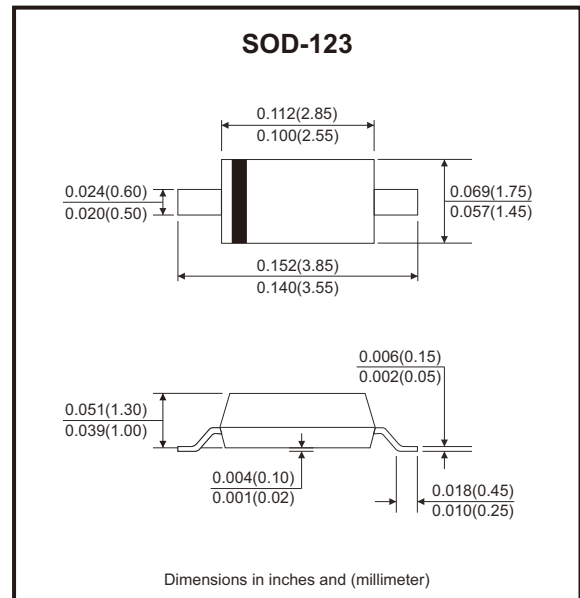

### Circuit Diagram



### Maximum Ratings (TA=25°C unless otherwise noted)

Parameter	Symbol	Value	Unit
Forward voltage @ IF=10mA	V <sub>F</sub>	0.9	V
Power dissipation	P <sub>D</sub>	500	mW
Thermal resistance, junction to ambient air	R <sub>θJA</sub>	350	°C/W
Junction temperature	T <sub>J</sub>	150	°C
Storage temperature range	T <sub>STG</sub>	-65 to +150	°C

Note: 1. Device mounted on ceramic PCB; 7.6mm x 9.4mm x 0.87mm with pad areas 25mm<sup>2</sup>.  
2. Tested with pulses, T<sub>p</sub> ≤ 1.0ms.

## Electrical Characteristics (TA=25°C unless otherwise noted)

Part Number	Zener Voltage Range			Test Current	Maximum Zener Impedance		Maximum Reverse Leakage Current		Marking Code
	Vz@ IZT				ZZT@ IZT	Zzk@ Izk=0.25mA	IR @ VR		
	Nom(V)	Min(V)	Max(V)	(mA)	(Ω)	(Ω)	(μA)	(V)	
AMMSZ5221B-HF	2.4	2.28	2.52	20	30	1200	100	1.0	C1
AMMSZ5223B-HF	2.7	2.57	2.84	20	30	1300	75	1.0	C3
AMMSZ5225B-HF	3.0	2.85	3.15	20	30	1600	50	1.0	C5
AMMSZ5226B-HF	3.3	3.14	3.47	20	28	1600	25	1.0	G1
AMMSZ5227B-HF	3.6	3.42	3.78	20	24	1700	15	1.0	G2
AMMSZ5228B-HF	3.9	3.71	4.10	20	23	1900	10	1.0	G3
AMMSZ5229B-HF	4.3	4.09	4.52	20	22	2000	5.0	1.0	G4
AMMSZ5230B-HF	4.7	4.47	4.94	20	19	1900	5.0	2.0	G5
AMMSZ5231B-HF	5.1	4.85	5.36	20	17	1600	5.0	2.0	E1
AMMSZ5232B-HF	5.6	5.32	5.88	20	11	1600	5.0	3.0	E2
AMMSZ5233B-HF	6.0	5.70	6.30	20	7	1600	5.0	3.5	E3
AMMSZ5234B-HF	6.2	5.89	6.51	20	7	1000	5.0	4.0	E4
AMMSZ5235B-HF	6.8	6.46	7.14	20	5	750	3.0	5.0	E5
AMMSZ5236B-HF	7.5	7.13	7.88	20	6	500	3.0	6.0	F1
AMMSZ5237B-HF	8.2	7.79	8.61	20	8	500	3.0	6.5	F2
AMMSZ5238B-HF	8.7	8.27	9.14	20	8	600	3.0	6.5	F3
AMMSZ5239B-HF	9.1	8.65	9.56	20	10	600	3.0	7.0	F4
AMMSZ5240B-HF	10	9.50	10.50	20	17	600	3.0	8.0	F5
AMMSZ5241B-HF	11	10.45	11.55	20	22	600	2.0	8.4	H1
AMMSZ5242B-HF	12	11.40	12.60	20	30	600	1.0	9.1	H2
AMMSZ5243B-HF	13	12.35	13.65	9.5	13	600	0.5	9.9	H3
AMMSZ5244B-HF	14	13.30	14.70	9.0	15	600	0.1	10.0	H4
AMMSZ5245B-HF	15	14.25	15.75	8.5	16	600	0.1	11	H5
AMMSZ5246B-HF	16	15.20	16.80	7.8	17	600	0.1	12	J1
AMMSZ5247B-HF	17	16.15	17.85	7.5	19	600	0.1	13	J2
AMMSZ5248B-HF	18	17.10	18.90	7.0	21	600	0.1	14	J3
AMMSZ5250B-HF	20	19.00	21.00	6.2	25	600	0.1	15	J5
AMMSZ5251B-HF	22	20.90	23.10	5.6	29	600	0.1	17	K1
AMMSZ5252B-HF	24	22.80	25.20	5.2	33	600	0.1	18	K2
AMMSZ5254B-HF	27	25.65	28.35	5.0	41	600	0.1	21	K4

Company reserves the right to improve product design , functions and reliability without notice.

REV:A

## Electrical Characteristics (TA=25°C unless otherwise noted)

Part Number	Zener Voltage Range			Test Current	Maximum Zener Impedance		Maximum Reverse Leakage Current		Marking Code
	Vz@ IZT			IZT	ZzT@ IZT	Zzk@ Izk=0.25mA	IR @ VR		
	Nom(V)	Min(V)	Max(V)	(mA)	(Ω)	(Ω)	(μA)	(V)	
AMMSZ5255B-HF	28	26.60	29.40	4.5	44	600	0.1	21	K5
AMMSZ5256B-HF	30	28.50	31.50	4.2	49	600	0.1	23	M1
AMMSZ5257B-HF	33	31.35	34.65	3.8	58	700	0.1	25	M2
AMMSZ5258B-HF	36	34.20	37.80	3.4	70	700	0.1	27	M3
AMMSZ5259B-HF	39	37.05	40.95	3.2	80	800	0.1	30	M4
AMMSZ5260B-HF	43	40.85	45.15	3.0	93	900	0.1	33	M5
AMMSZ5261B-HF	47	44.65	49.35	2.7	105	1000	0.1	36	N1
AMMSZ5262B-HF	51	48.45	53.55	2.5	125	1100	0.1	39	N2
AMMSZ5263B-HF	56	53.20	58.80	2.2	150	1300	0.1	43	M8
AMMSZ5265B-HF	62	58.90	65.10	2.0	185	1400	0.1	47	N5
AMMSZ5267B-HF	75	71.25	78.75	1.7	270	1700	0.1	56	P2

## Rating and Characteristic Curves (AMMSZ5221B-HF Thru. AMMSZ5267B-HF)

Fig.1 - Power Dissipation vs Ambient Temperature

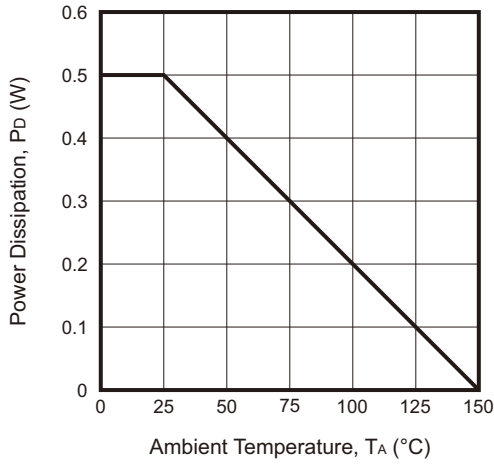

Fig.2 - Total Capacitance vs Nominal Zener Voltage

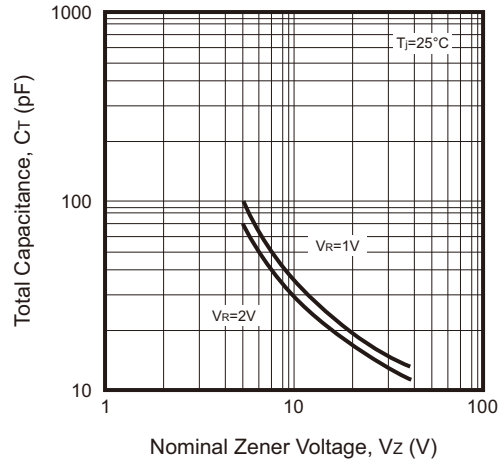

Fig.3 - Effect of Zener Voltage on Impedance

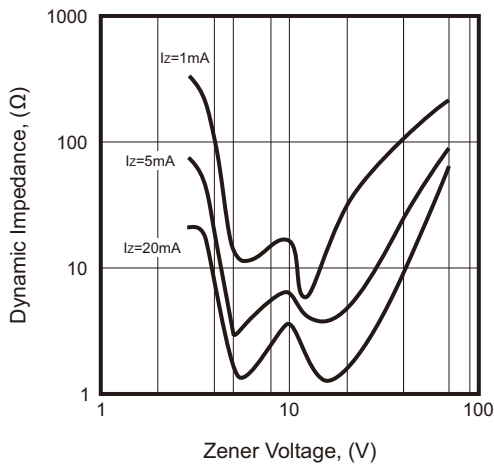

Fig.4 - Zener Breakdown Characteristics

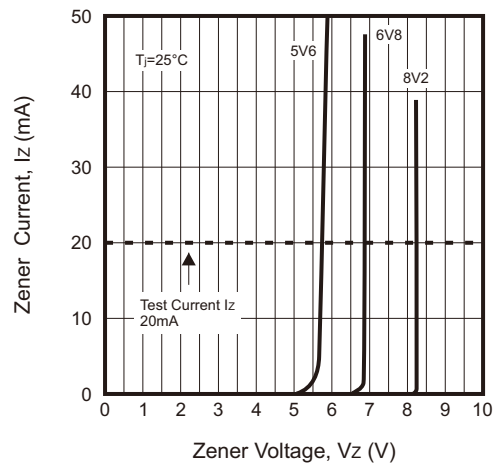

Fig.5 - Zener Breakdown Characteristics

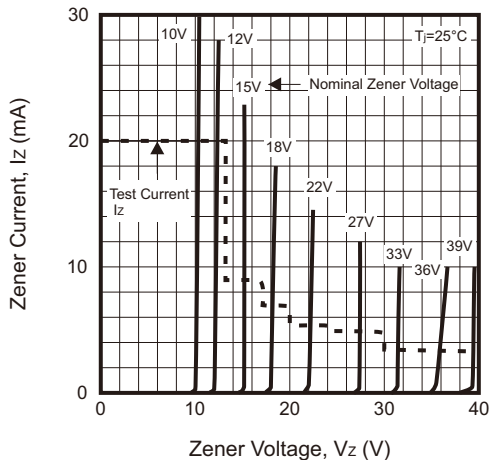
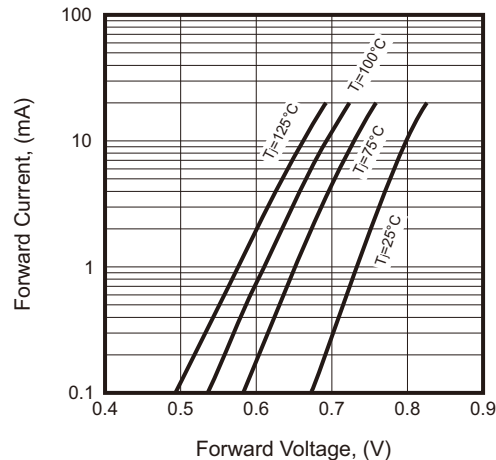
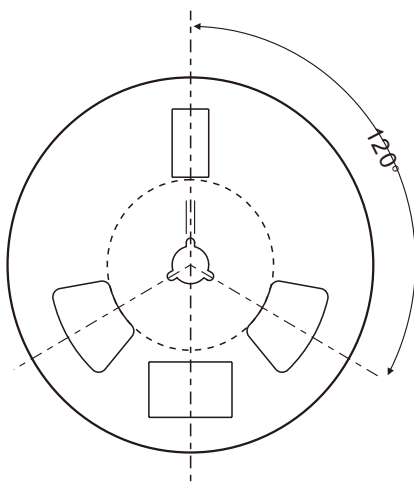

Fig.6 - Forward voltages vs Forward Currents That with Multiple Temperature Curves (Example Shown Below)



## Reel Taping Specification



SOD-123	SYMBOL	A	B	C	d	D	D1	D2
	(mm)	1.85 ± 0.10	3.94 ± 0.10	1.57 ± 0.10	1.55 ± 0.05	178.00 ± 1.00	54.00 ± 0.50	13.00 ± 0.50
	(inch)	0.073 ± 0.004	0.155 ± 0.004	0.062 ± 0.004	0.061 ± 0.002	7.008 ± 0.039	2.126 ± 0.020	0.512 ± 0.020

SOD-123	SYMBOL	E	F	P	P1	P0	W	W1
	(mm)	1.75 ± 0.10	3.50 ± 0.05	4.00 ± 0.10	2.00 ± 0.05	4.00 ± 0.10	8.00 + 0.30 - 0.10	9.50 ± 1.00
	(inch)	0.069 ± 0.004	0.138 ± 0.002	0.157 ± 0.004	0.079 ± 0.002	0.157 ± 0.004	0.315 + 0.012 - 0.004	0.374 ± 0.039

Company reserves the right to improve product design, functions and reliability without notice. REV:A