

AMT ENCODER SERIES

Assembly Instructions

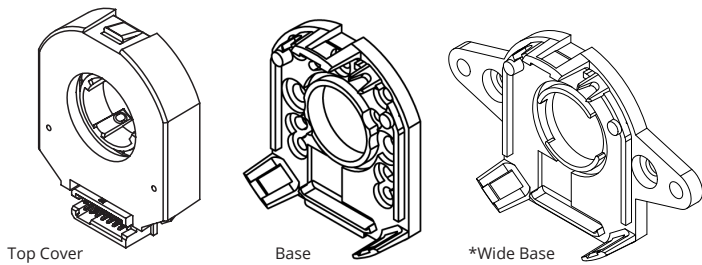

Top Cover

Base

*Wide Base

Sleeve Sizes:

- 2 mm = Light Blue
- 3 mm = Orange
- 3.175 mm (1/8") = Purple
- 4 mm = Gray
- 4.76 mm (3/16") = Yellow
- 5 mm = Green
- 6 mm = Red
- 6.35 mm (1/4") = White
- 8 mm = Blue

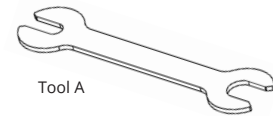

Tool A

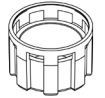

Shaft Adaptor



Sleeve

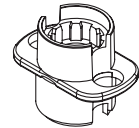

Tool C

STEP 1

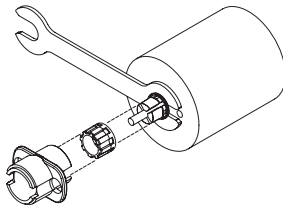

1. Insert Tool A as a spacer that defines the distance to the mounting surface.
2. Slide appropriate sized Sleeve over shaft all the way down to Tool A.
3. Slide Shaft Adaptor over Sleeve.
4. Use Tool C to press Shaft Adaptor over Sleeve (ensure Shaft Adapter and Tool C spline alignment) until flush with Tool A.

STEP 2

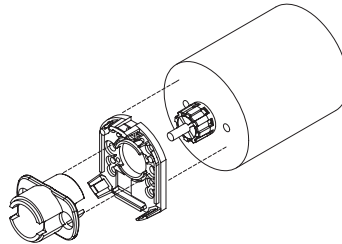

1. Remove Tools A and C.
2. Place Base on motor, with Tool C used as a centering tool.

STEP 3

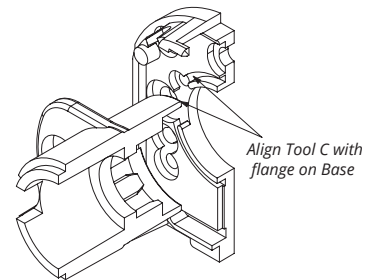

Align Tool C with flange on Base

1. Align Tool C with flange on Base.
2. Slide Base and Tool C onto motor, centering onto the Shaft Adapter.

STEP 4

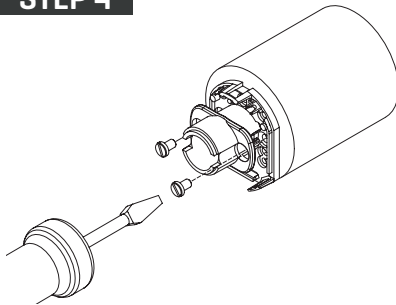

1. Fasten the Base on the motor (Tool C may need to be rotated to allow for some mounting configurations).
2. Remove Tool C.

STEP 5

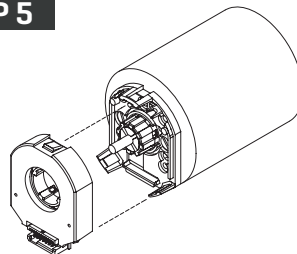

1. Snap the Top Cover onto the Base, carefully observing that the teeth of the Shaft Adaptor align with the grooves in the hub.*

* We recommend no more than three cycles of mounting and removal of the AMT top cover base. Multiple cycles of mounting and removing the top cover can cause base fatigue over time and affect encoder performance.

STEP 6

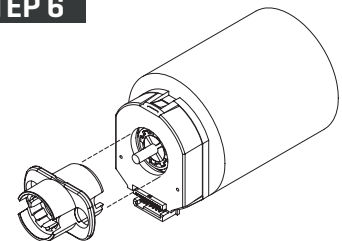

1. Make sure the snaps are fully engaged by pressing on the Hub with the reverse side of Tool C.
2. When assembly is finished, the Shaft Adaptor, Sleeve and Rotor Hub should all be flush with the Motor Shaft rotating freely.

For additional instructions or information contact customer support at: 877.323.3576

For more information visit: www.cuidevices.com/amt

CUI Devices' products are not intended for applications where a failure could result in costly, dangerous, or life threatening situations. CUI Devices will not be responsible for damages, or losses greater than the cost of the CUI Devices replacement parts.

CUI DEVICES

6405 SW Rosewood St, Ste C
Lake Oswego, OR 97035

© 2020 CUI Devices. All rights reserved.
Information in this document is subject to change without notice.