

## Datasheet

### CW-RCL Series 868 MHz Right-Angle Whip Antenna

The 868-CW-RCL antenna is designed for sub-1 GHz and low-power, wide-area (LPWA) applications including LoRaWAN®, Sigfox®, and ISM band applications in the 862 MHz to 876 MHz range.

The right-angle swivel design of the 868-CW-RCL antenna allows for the antenna to be positioned for optimum performance.

The ANT-868-CW-RCL antenna is available with an SMA plug (male pin) connector.



#### Features

- Performance at 862 MHz to 876 MHz
  - VSWR:  $\leq 1.9$
  - Peak Gain: 4.1 dBi
  - Efficiency: 71%
- Compact size
  - 97.7 mm x 18.7 mm x 10.5 mm
- Rotating base allows for optimal positioning
- SMA plug (male pin) connector

#### Applications

- Low-power, wide-area (LPWA) applications
  - LoRaWAN®
  - Sigfox®
- ISM band applications
- Internet of Things (IoT) devices
- Smart Home networking
  - Security systems
  - Industrial machinery
  - AMR (automated meter reading)
  - Home weather stations
- Remote sensing, monitoring and control
  - Industrial machinery
  - AMR (automated meter reading)
- Gateways

#### Ordering Information

Part Number	Description
ANT-868-CW-RCL-SMA	868 MHz right-angle whip antenna with SMA plug (male pin)

Available from Linx Technologies and select distributors and representatives.

Electrical Specifications

ANT-868-CW-RCL	868 MHz
Frequency Range	862 MHz to 876 MHz
VSWR (max)	1.9
Peak Gain (dBi)	4.1
Average Gain (dBi)	-1.5
Efficiency (%)	71
Polarization	Linear
Radiation	Omnidirectional
Max Power	5 W
Wavelength	1/4-wave
Electrical Type	Monopole
Impedance	50 Ω
Connection	SMA plug (male pin)
Operating Temperature Range	-20 °C to +85 °C
Weight	12.5 g (0.44 oz)
Dimensions	97.7 mm x 18.7 mm x 10.5 (3.80 in x 0.74 in x 0.41 in)

Electrical specifications and plots measured with a 102 mm x 102 mm (4.0 in x 4.0 in) reference ground plane.

Packaging Information

The CW-RCL series antennas are packaged, 50 pcs in a clear plastic bag, 500 pcs per inner box, and 2000 pcs per export box. Distribution channels may offer alternative packaging options.

Product Dimensions

Figure 1 provides dimensions of the ANT-868-CW-RCL. The rotating base allows for continuous positioning through 360 degrees even while installed.

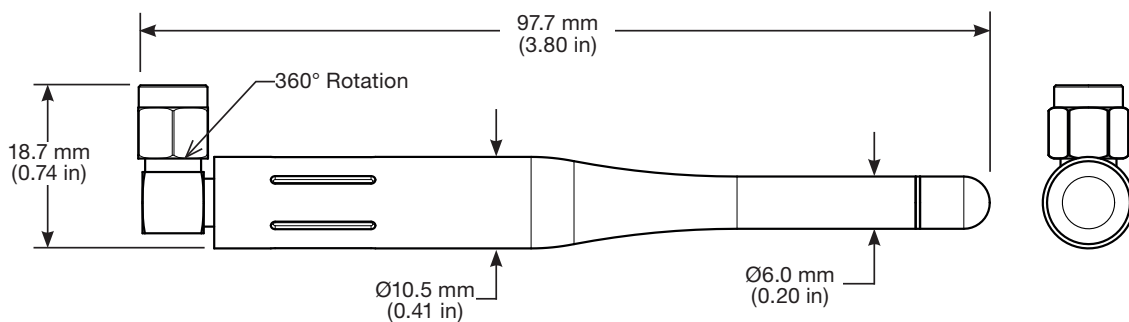

Figure 1. ANT-868-CW-RCL Antenna Dimensions

## Counterpoise

1/4-Wave monopole antennas require an associated ground plane counterpoise for proper operation. The size and location of the ground plane relative to the antenna will affect the overall performance of the antenna in the final design. When used in conjunction with a ground plane smaller than that used to tune the antenna, the center frequency typically will shift higher in frequency and the bandwidth will decrease. The proximity of other circuit elements and packaging near the antenna will also affect the final performance.

For further discussion and guidance on the importance of the ground plane counterpoise, please refer to Linx Application Note, *AN-00501: Understanding Antenna Specifications and Operation*.

## Antenna Orientation

The ANT-868-CW-RCL is characterized on the edge of a 102 mm x 102 mm ground plane as shown in Figure 2. This orientation, represents the most common orientation in end-product use.

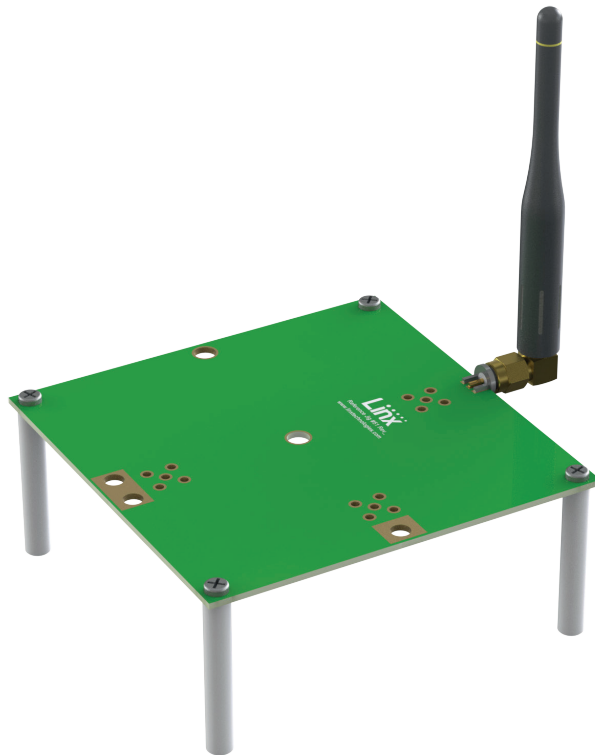

Figure 2. ANT-868-CW-RCL on Evaluation PCB

VSWR

Figure 3 provides the voltage standing wave ratio (VSWR) across the antenna bandwidth. VSWR describes the power reflected from the antenna back to the radio. A lower VSWR value indicates better antenna performance at a given frequency. Reflected power is also shown on the right-side vertical axis as a gauge of the percentage of transmitter power reflected back from the antenna.

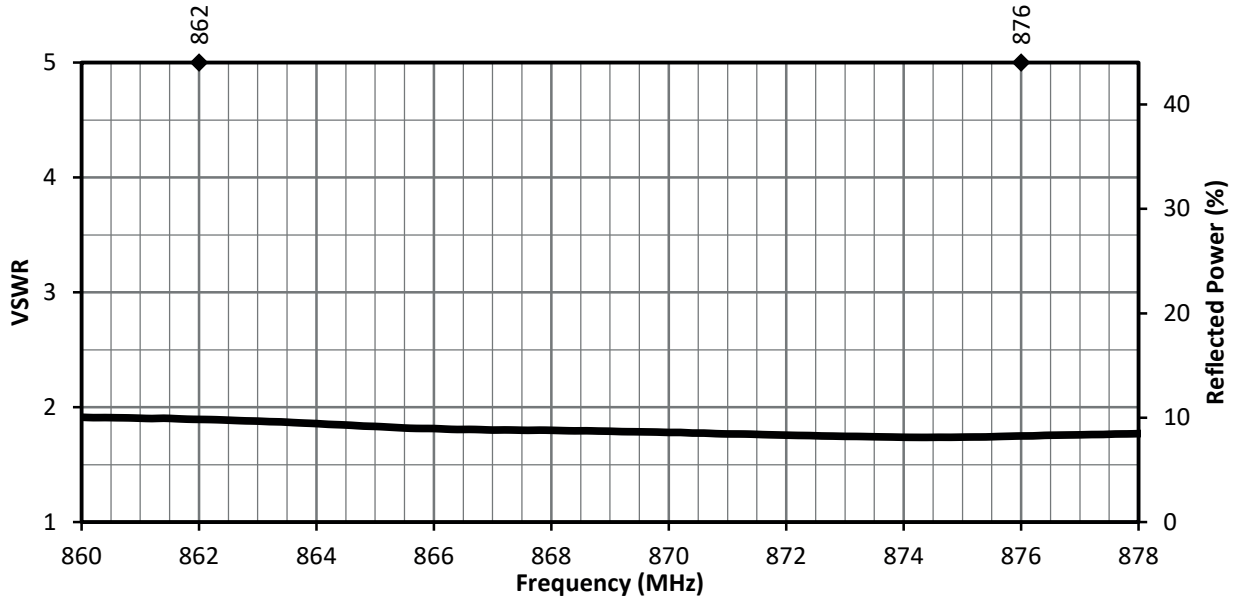

Figure 3. ANT-868-CW-RCL VSWR

Return Loss

Return loss (Figure 4), represents the loss in power at the antenna due to reflected signals. Like VSWR, a lower return loss value indicates better antenna performance at a given frequency.

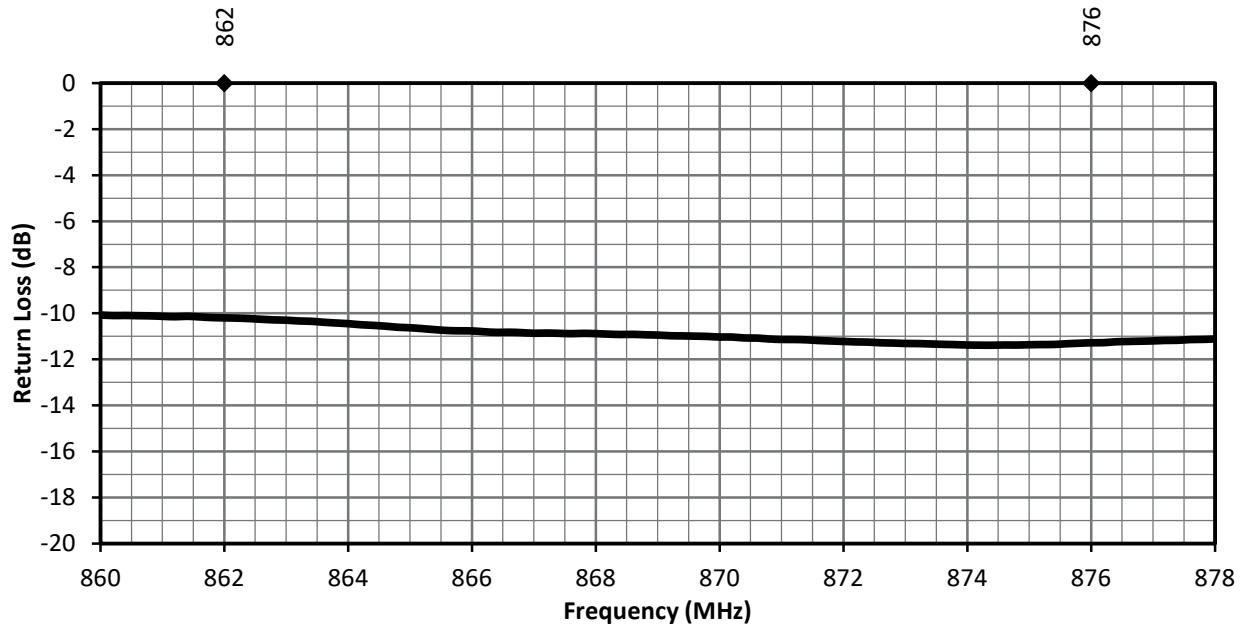

Figure 4. ANT-868-CW-RCL Return Loss

### Peak Gain

The peak gain across the antenna bandwidth is shown in Figure 5. Peak gain represents the maximum antenna input power concentration across 3-dimensional space, and therefore peak performance at a given frequency, but does not consider any directionality in the gain pattern.

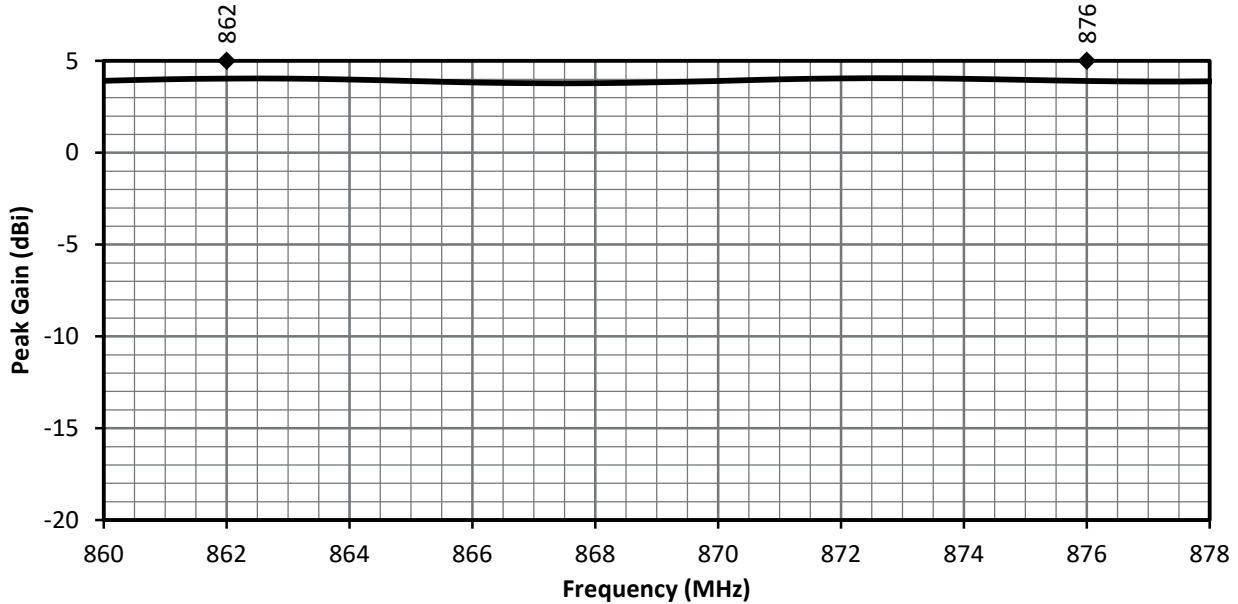

Figure 5. ANT-868-CW-RCL Peak Gain

### Average Gain

Average gain (Figure 6), is the average of all antenna gain in 3-dimensional space at each frequency, providing an indication of overall performance without expressing antenna directionality.

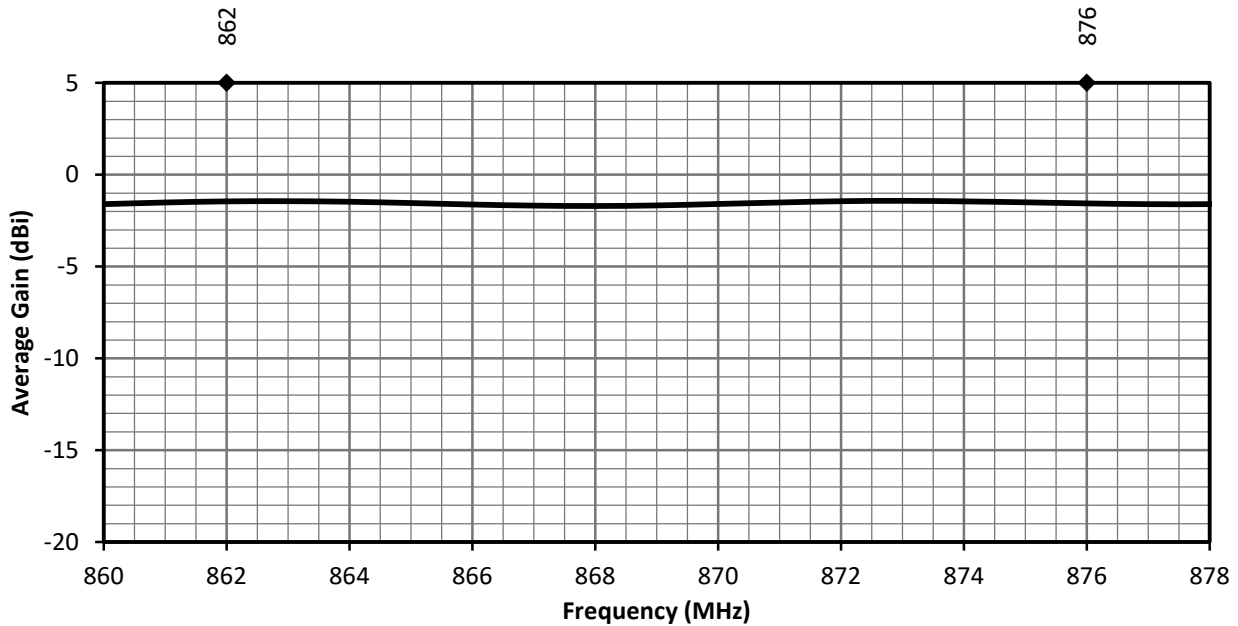

Figure 6. ANT-868-CW-RCL Antenna Average Gain

### Radiation Efficiency

Radiation efficiency (Figure 7), shows the ratio of power delivered to the antenna relative to the power radiated at the antenna, expressed as a percentage, where a higher percentage indicates better performance at a given frequency.

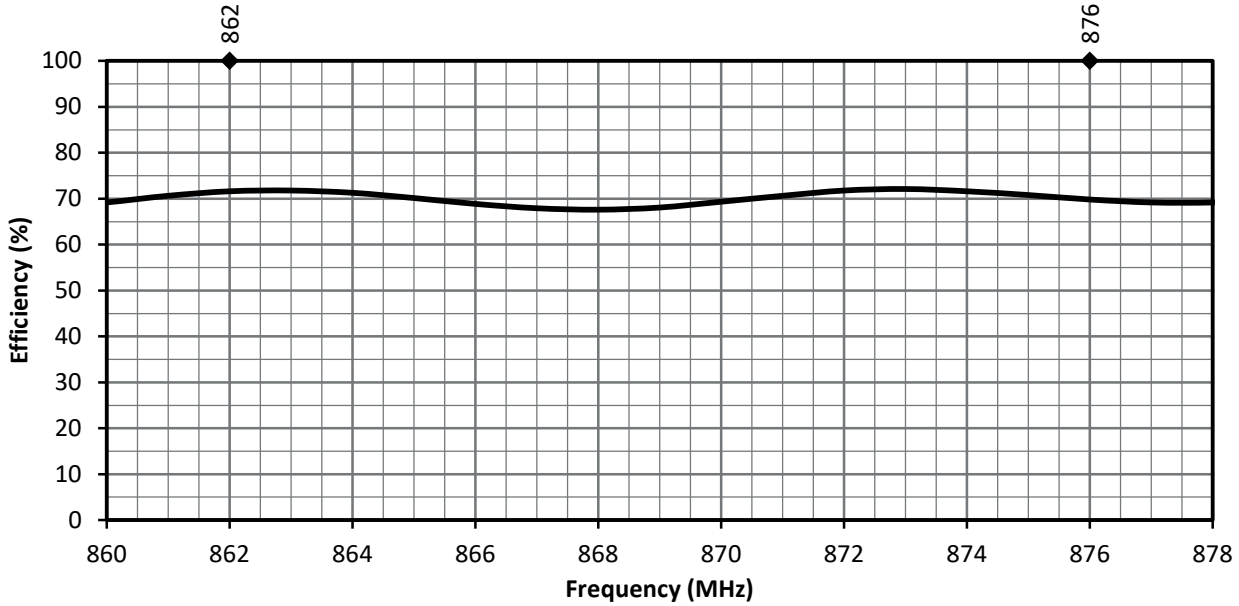
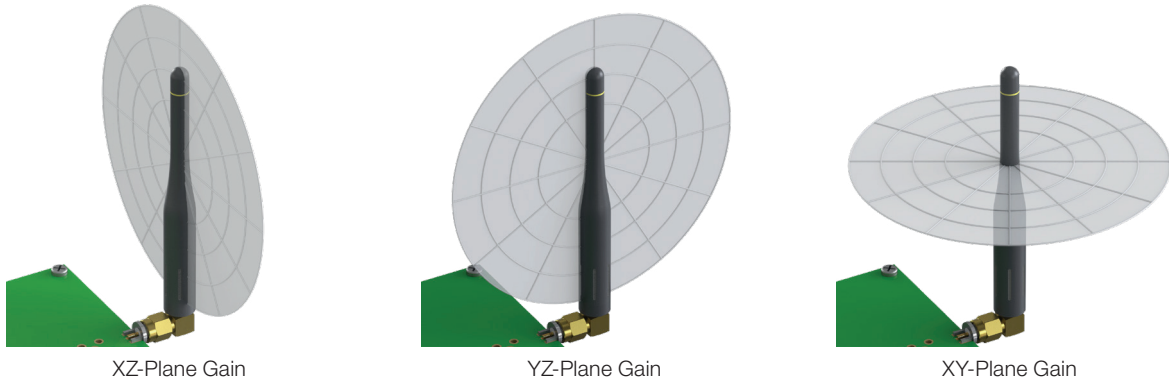

Figure 7. ANT-868-CW-RCL Antenna Radiation Efficiency

Radiation Patterns

Radiation patterns provide information about the directionality and 3-dimensional gain performance of the antenna by plotting gain at specific frequencies in three orthogonal planes. Antenna radiation patterns are shown in Figure 8 using polar plots covering 360 degrees. The antenna graphic at the top of the page provides reference to the plane of the column of plots below it. Note: when viewed with typical PDF viewing software, zooming into radiation patterns is possible to reveal fine detail.



862 MHz to 876 MHz (868 MHz)

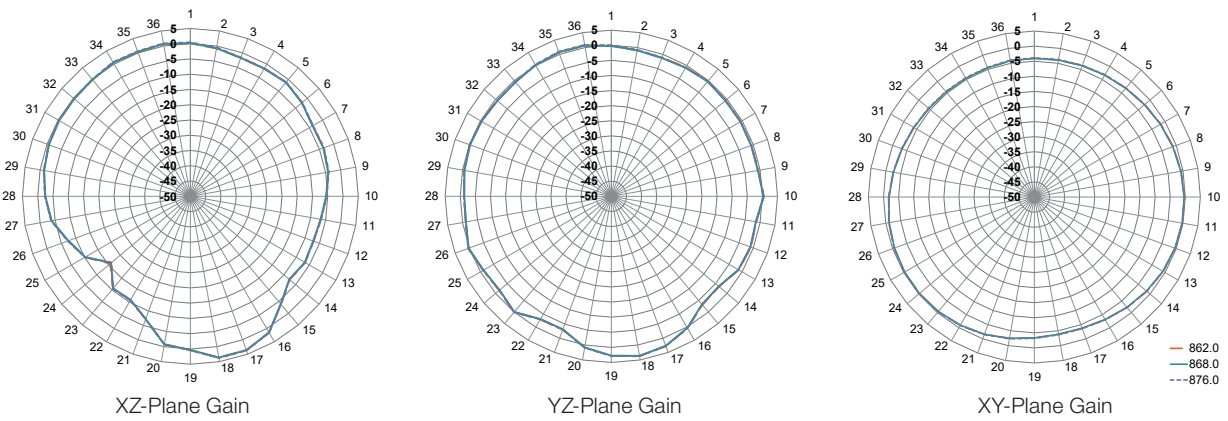

Figure 8. ANT-868-CW-RCL Radiation Patterns