



ANT-868-NUB-ccc

868 MHz LPWA Whip Antenna

The ANT-868-NUB-ccc is an extremely compact whip-style antenna designed for sub-1 GHz and low-power, wide-area (LPWA) applications including LoRaWAN® and Sigfox®, IoT, remote controls, and ISM band applications in the 862 MHz to 876 MHz range.

The ANT-868-NUB-ccc is a rugged monopole antenna with a length of less than 20 mm. The ANT-868-NUB-ccc may be used with metallic and non-metallic enclosures. The antenna connects using an SMA plug (male pin) or RP-SMA plug (female socket) connector.

FEATURES

- Performance at 862 MHz to 876 MHz
 - VSWR: ≤ 1.7
 - Peak Gain: 4.2 dBi
 - Efficiency: 51%
- Compact size
 - Height 19.7 mm (0.78 in)
 - Diameter 7.0 mm (0.28 in)
- AEC-Q200 Grade 2 compliance
- Omnidirectional radiation pattern
- SMA plug (male pin) or RP-SMA plug (female socket) connection

APPLICATIONS

- Low-power, wide-area (LPWA) applications
 - LoRaWAN®, ITU-T Y.4480
 - Sigfox®
- ISM applications
- Remote control, sensing and monitoring
 - Security systems
 - Industrial machinery
 - Automated equipment
 - AMR (automated meter reading)
- Internet of Things (IoT) devices
- Smart Home networking
- Hand-held devices

ORDERING INFORMATION

Part Number	Description
ANT-868-NUB-RPS	868 MHz LPWA whip antenna with RP-SMA plug (female socket) connector
ANT-868-NUB-SMA	868 MHz LPWA whip antenna with SMA plug (male pin) connector

Available from Linx Technologies and select distributors and representatives.

TABLE 1. ELECTRICAL SPECIFICATIONS

ANT-868-NUB	868 MHz		
Frequency Range	862 MHz to 876 MHz		
VSWR (max)	1.7		
Peak Gain (dBi)	4.2		
Average Gain (dBi)	-2.9		
Efficiency (%)	51		
Polarization	Linear	Radiation	Omnidirectional
Max Power	25 W	Wavelength	1/4-wave
Electrical Type	Monopole	Impedance	50 Ω

Electrical specifications and plots measured at the edge of a 102 mm x 102 mm (4 in x 4 in) reference ground plane.

TABLE 2. MECHANICAL SPECIFICATIONS

Parameter	Value
Connection	SMA plug (male pin) or RP-SMA plug (female socket)
Dimensions	19.7 mm x \varnothing 7.0 mm (0.78 in x \varnothing 0.28 in)
Weight	2.9 g (0.10 oz)
Operating Temp. Range	-40 °C to +105 °C

PRODUCT DIMENSIONS

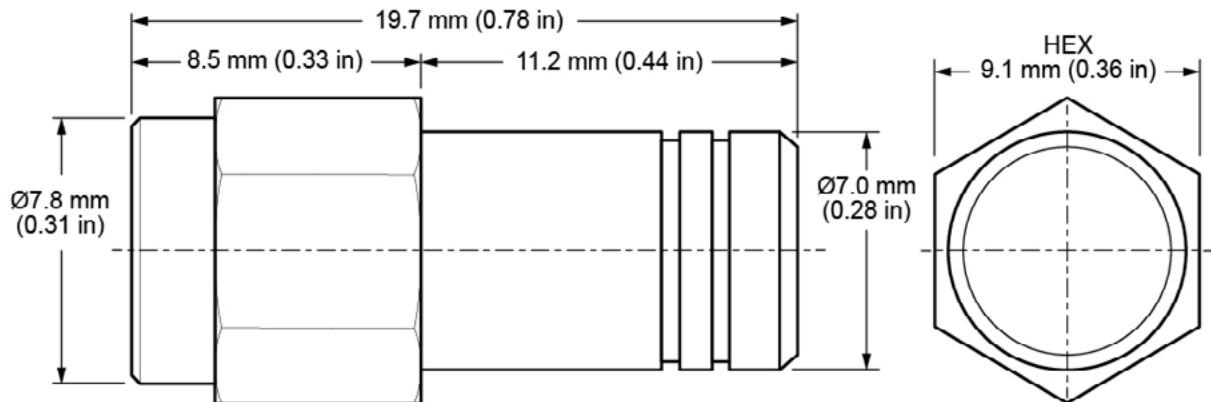

Figure 1. ANT-868-NUB-ccc Antenna Dimensions

PACKAGING INFORMATION

The ANT-868-NUB-ccc antenna is individually packaged in a sealed plastic bag, 50 pcs packed in a labeled clear polyethylene bag. Distribution channels may offer alternative packaging options.

COUNTERPOISE

Quarter-wave or monopole antennas require an associated ground plane counterpoise for proper operation. The size and location of the ground plane relative to the antenna will affect the overall performance of the antenna in the final design. When used in conjunction with a ground plane smaller than that used to tune the antenna, the center frequency typically will shift higher in frequency and the bandwidth will decrease. The proximity of other circuit elements and packaging near the antenna will also affect the final performance.

For further discussion and guidance on the importance of the ground plane counterpoise, please refer to Linx Application Note, AN-00501: Understanding Antenna Specifications and Operation.

ANTENNA ORIENTATION

The ANT-868-NUB-ccc antenna is characterized in two antenna orientations as shown in Figure 2. The antenna in a free space orientation characterizes use of an antenna attached to an enclosure-mounted connector which is connected by cable to a printed circuit board. Characterization at the edge of the ground plane (102 mm x 102 mm) provides insight into antenna performance when attached to a connector on a metal enclosure. The two orientations represent the most common end-product use cases.

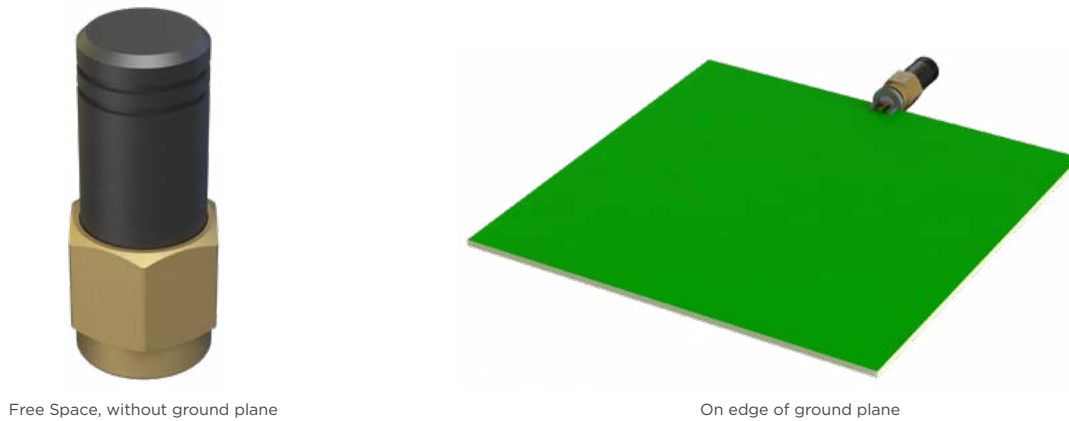

Figure 2. ANT-868-NUB-ccc Test Orientation

EDGE OF GROUND PLANE

The charts on the following pages represent data taken with the antenna oriented at the edge of the ground plane, as shown in Figure 3.



Figure 3. ANT-868-NUB-ccc on Edge of Ground Plane

VSWR

Figure 4 provides the voltage standing wave ratio (VSWR) across the antenna bandwidth. VSWR describes the power reflected from the antenna back to the radio. A lower VSWR value indicates better antenna performance at a given frequency. Reflected power is also shown on the right-side vertical axis as a gauge of the percentage of transmitter power reflected back from the antenna.

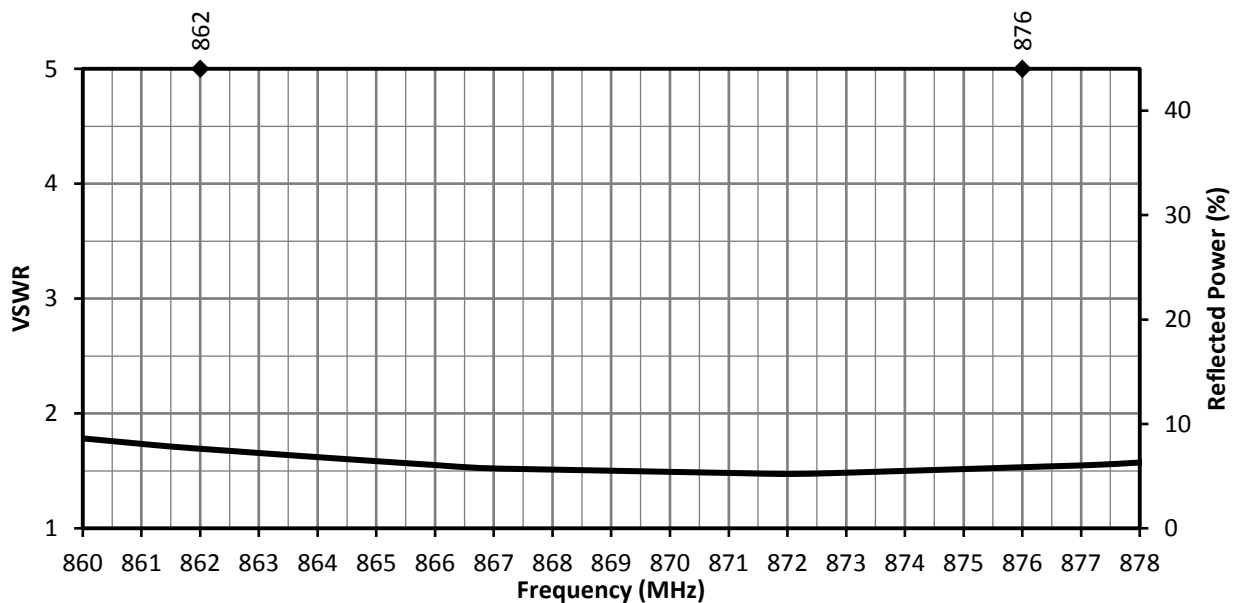

Figure 4. VSWR for ANT-868-NUB-ccc, Edge of ground Plane

RETURN LOSS

Return loss (Figure 5), represents the loss in power at the antenna due to reflected signals. Like VSWR, a lower return loss value indicates better antenna performance at a given frequency.

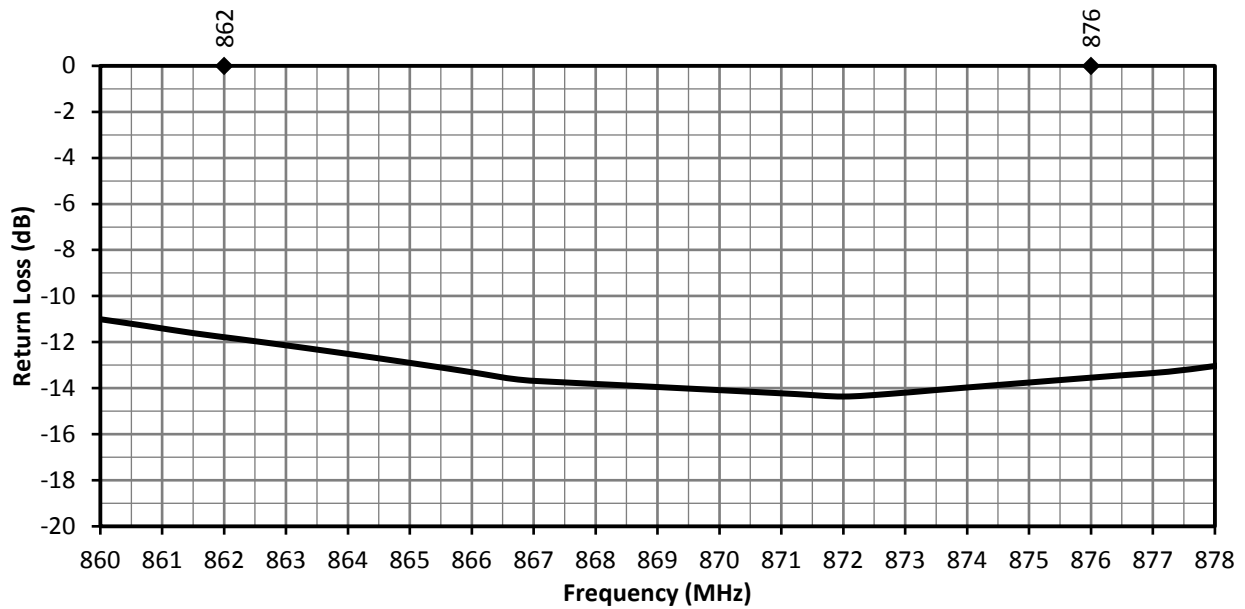

Figure 5. Return Loss for ANT-868-NUB-ccc, Edge of ground Plane

PEAK GAIN

The peak gain across the antenna bandwidth is shown in Figure 6. Peak gain represents the maximum antenna input power concentration across 3-dimensional space, and therefore peak performance, at a given frequency, but does not consider any directionality in the gain pattern.

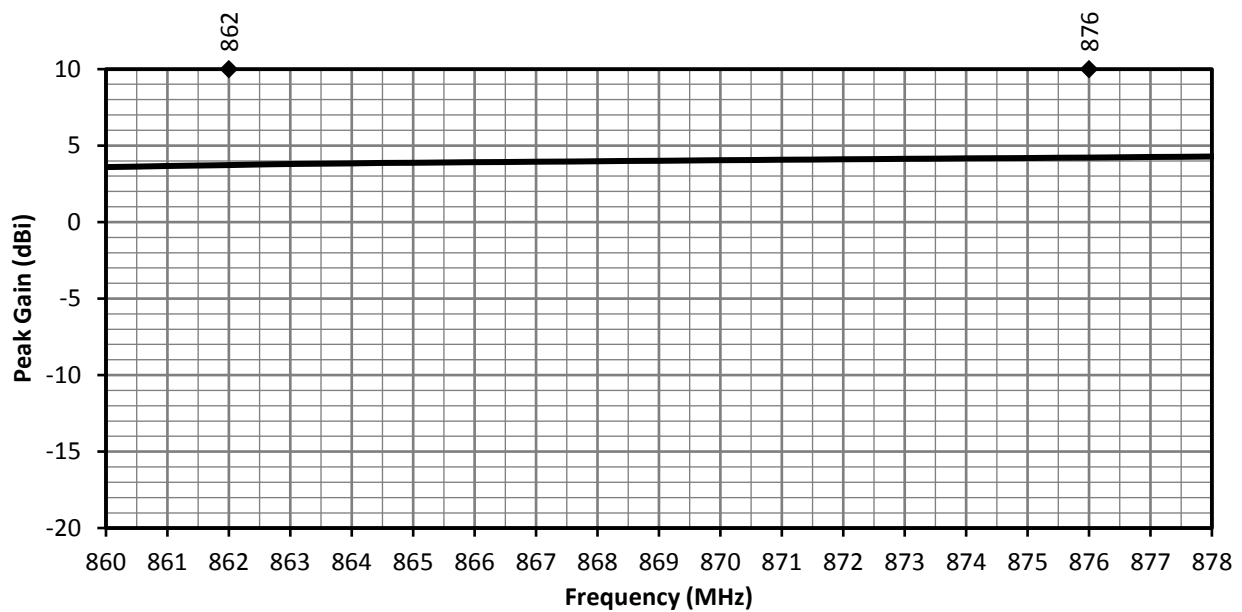

Figure 6. Peak Gain for ANT-868-NUB-ccc, Edge of ground Plane

AVERAGE GAIN

Average gain (Figure 7), is the average of all antenna gain in 3-dimensional space at each frequency, providing an indication of overall performance without expressing antenna directionality.

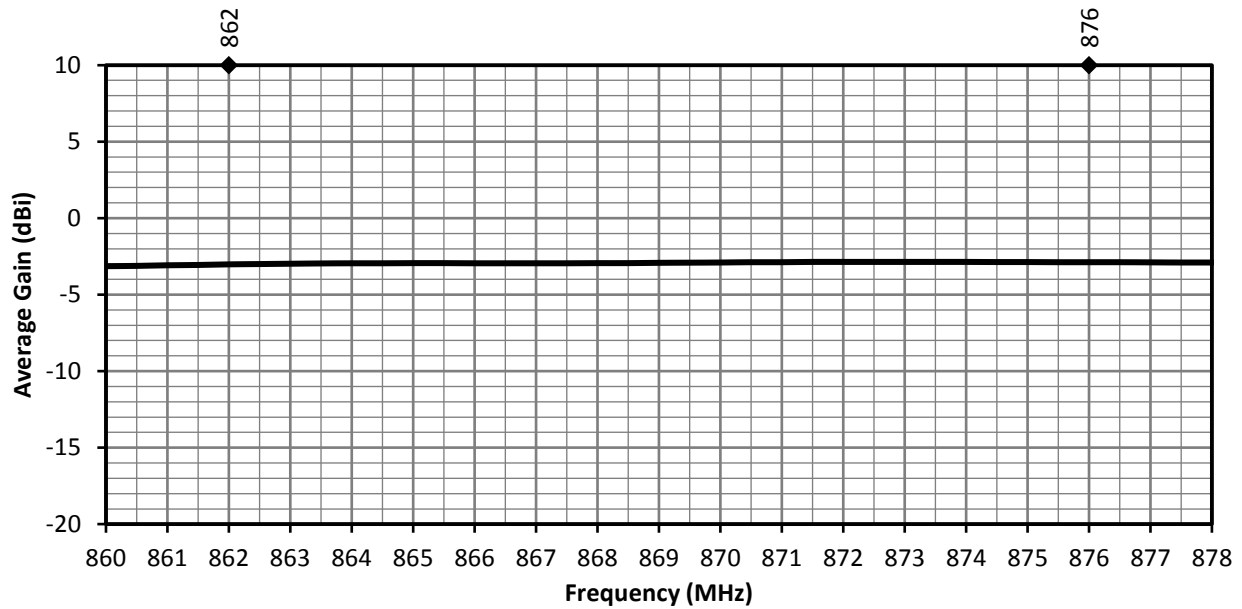

Figure 7. Antenna Average Gain for ANT-868-NUB-ccc, Edge of ground Plane

RADIATION EFFICIENCY

Radiation efficiency (Figure 8), shows the ratio of power delivered to the antenna relative to the power radiated at the antenna, expressed as a percentage, where a higher percentage indicates better performance at a given frequency.

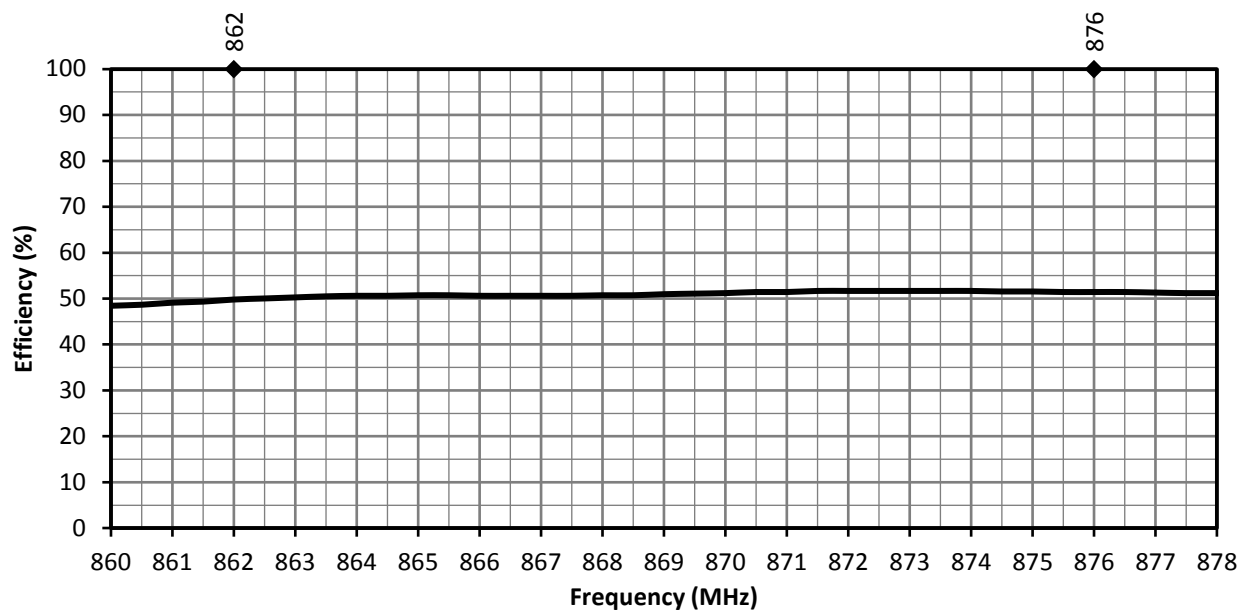
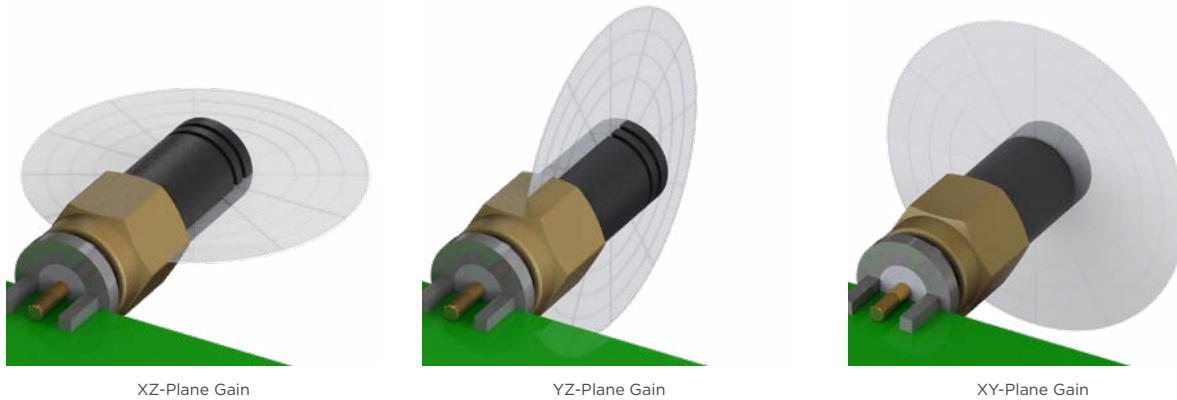

Figure 8. Antenna Radiation Efficiency for ANT-868-NUB-ccc, Edge of ground Plane

RADIATION PATTERNS

Radiation patterns provide information about the directionality and 3-dimensional gain performance of the antenna by plotting gain at specific frequencies in three orthogonal planes. Antenna radiation patterns (Figure 9), are shown using polar plots covering 360 degrees. The antenna graphic above the plots provides reference to the plane of the column of plots below it. Note: when viewed with typical PDF viewing software, zooming into radiation patterns is possible to reveal fine detail.

RADIATION PATTERNS - EDGE OF GROUND PLANE



862 MHz TO 876 MHz (868 MHz)

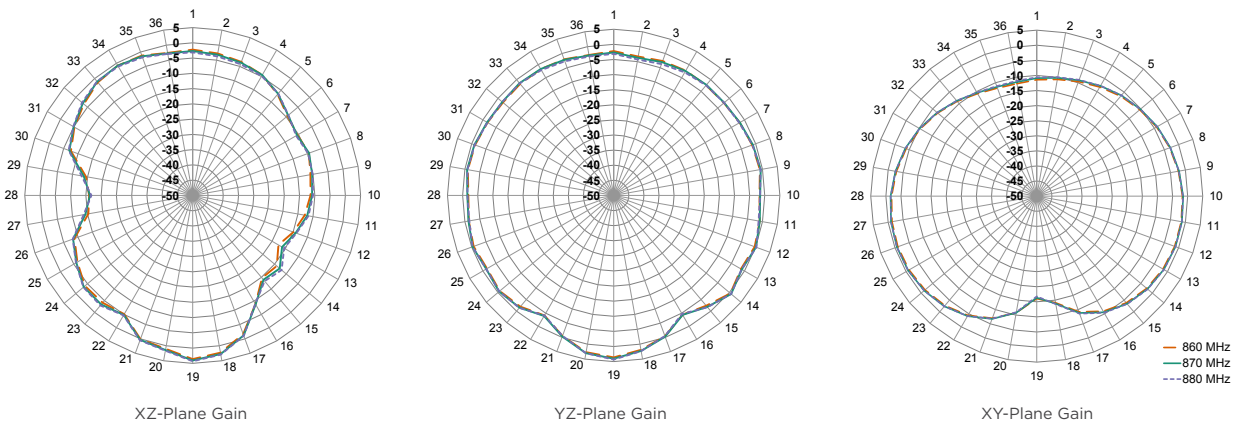

Figure 9. Radiation Patterns for ANT-868-NUB-ccc Antenna, Edge of ground Plane

ANTENNA ORIENTATION

The charts on the following pages represent data taken with the antenna in free space, no ground plane, as shown in Figure 10.



Figure 10. ANT-868-NUB-ccc, Free Space

VSWR

Figure 11 provides the voltage standing wave ratio (VSWR) across the antenna bandwidth. VSWR describes the power reflected from the antenna back to the radio. A lower VSWR value indicates better antenna performance at a given frequency. Reflected power is also shown on the right-side vertical axis as a gauge of the percentage of transmitter power reflected back from the antenna.

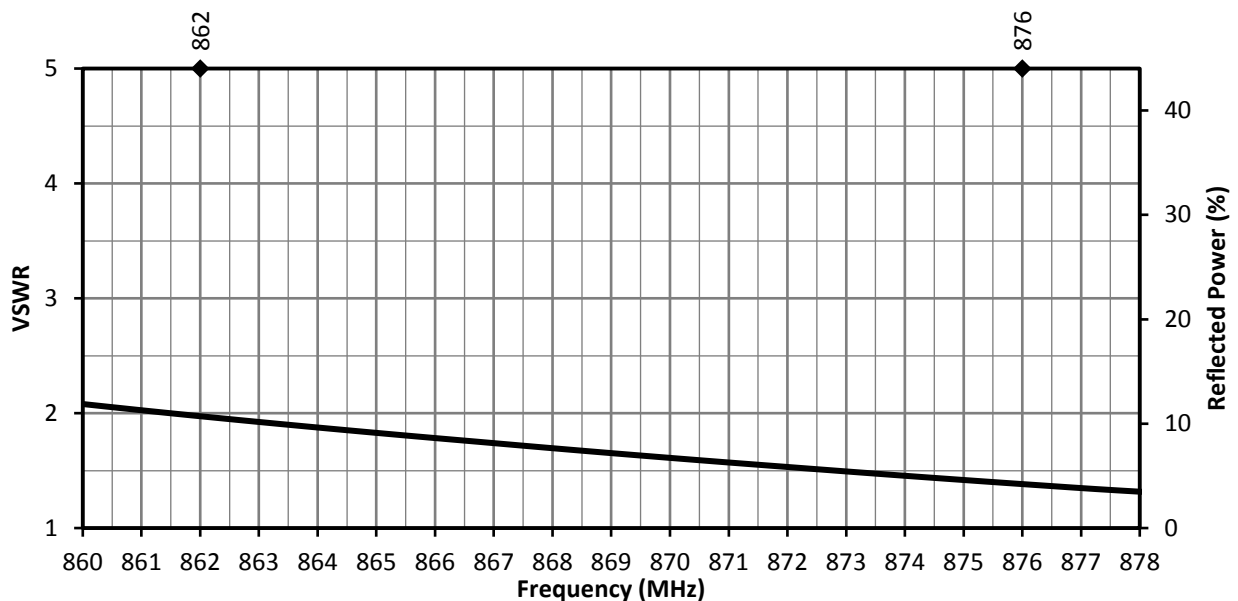

Figure 11. ANT-8/9-IPW2-NP Antenna VSWR, Center of Ground Plane

RETURN LOSS

Return loss (Figure 12), represents the loss in power at the antenna due to reflected signals. Like VSWR, a lower return loss value indicates better antenna performance at a given frequency.

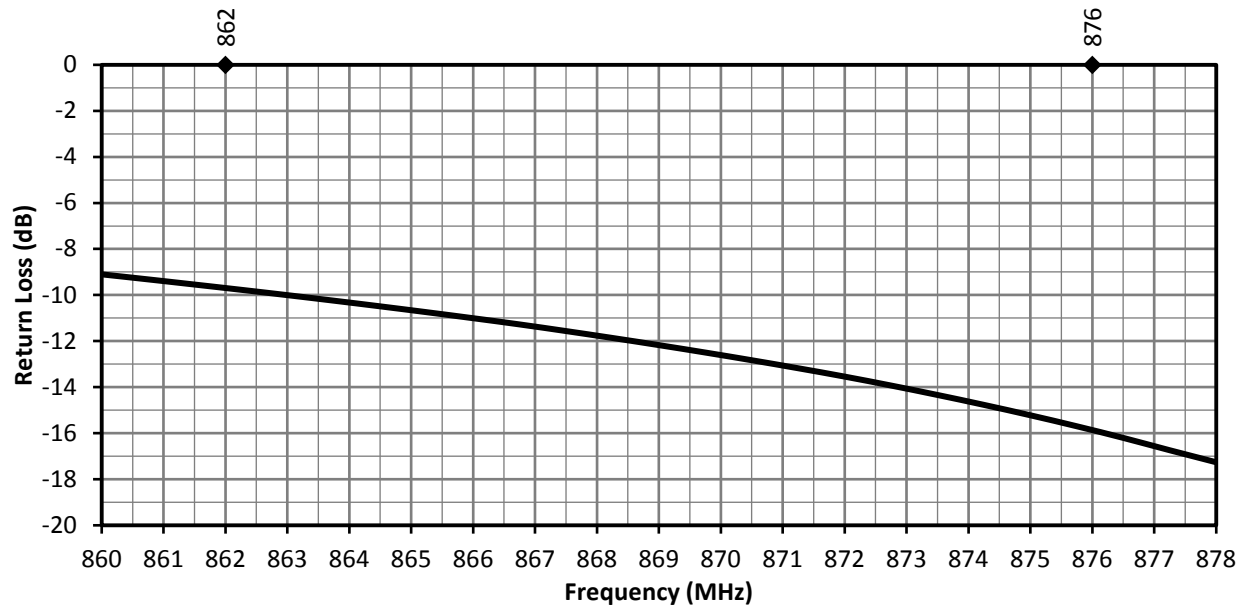

Figure 12. Return Loss for ANT-868-NUB-ccc Antenna in Free Space

PEAK GAIN

The peak gain across the antenna bandwidth is shown in Figure 13. Peak gain represents the maximum antenna input power concentration across 3-dimensional space, and therefore peak performance, at a given frequency, but does not consider any directionality in the gain pattern.

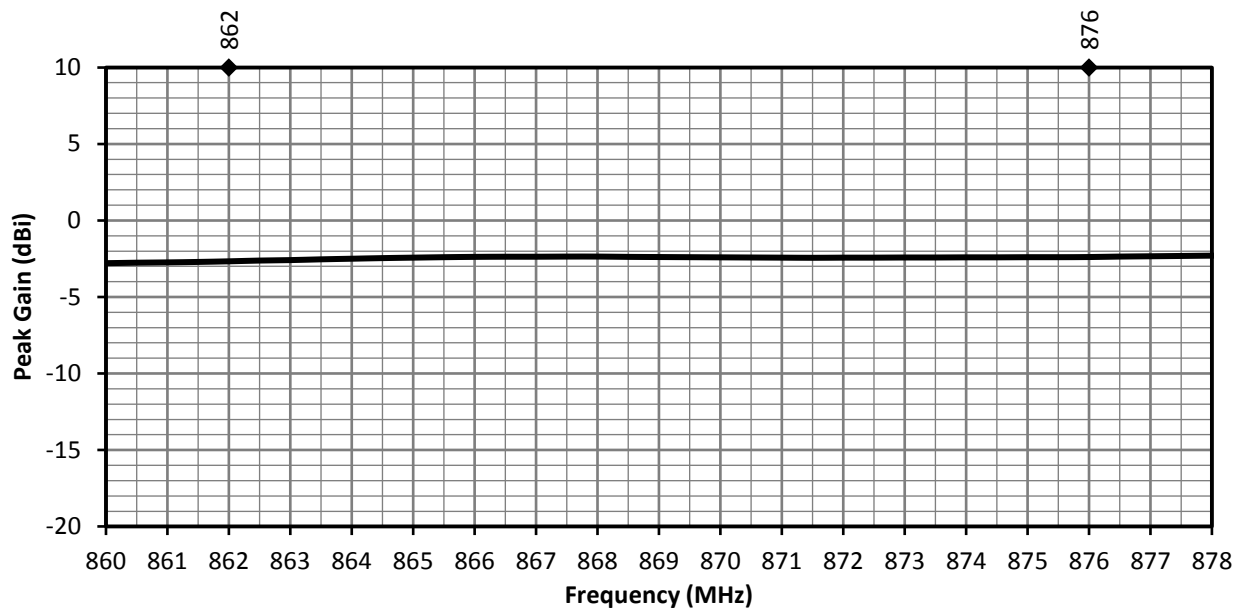

Figure 13. Peak Gain for ANT-868-NUB-ccc Antenna in Free Space

AVERAGE GAIN

Average gain (Figure 14), is the average of all antenna gain in 3-dimensional space at each frequency, providing an indication of overall performance without expressing antenna directionality.

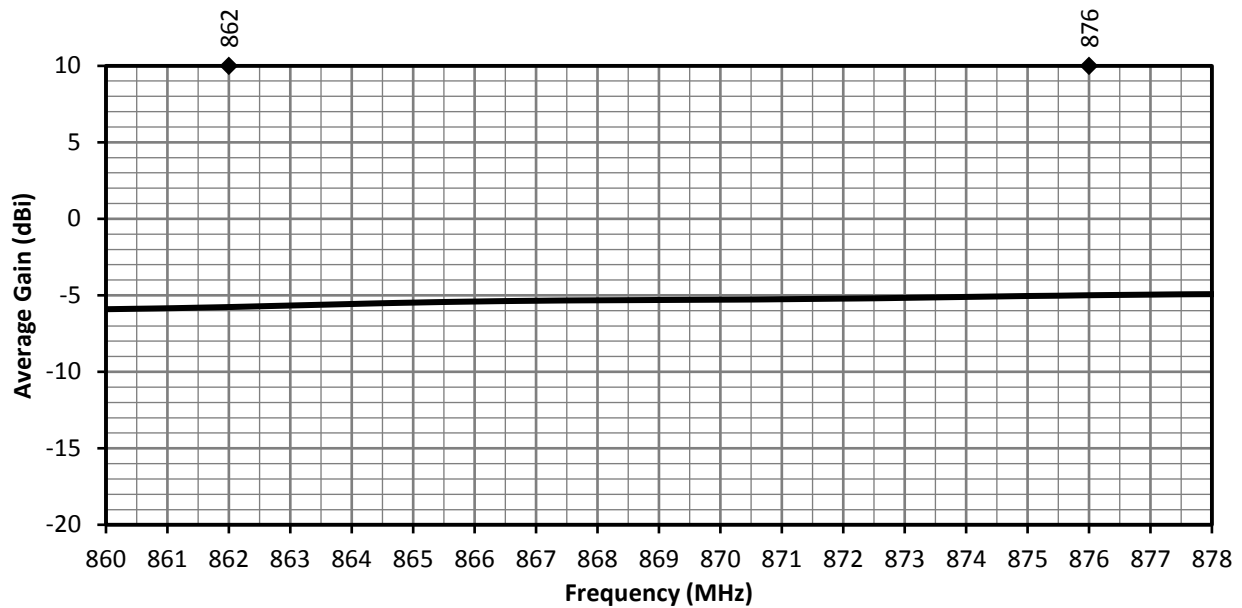

Figure 14. Antenna Average Gain for ANT-868-NUB-ccc Antenna in Free Space

RADIATION EFFICIENCY

Radiation efficiency (Figure 15), shows the ratio of power delivered to the antenna relative to the power radiated at the antenna, expressed as a percentage, where a higher percentage indicates better performance at a given frequency.

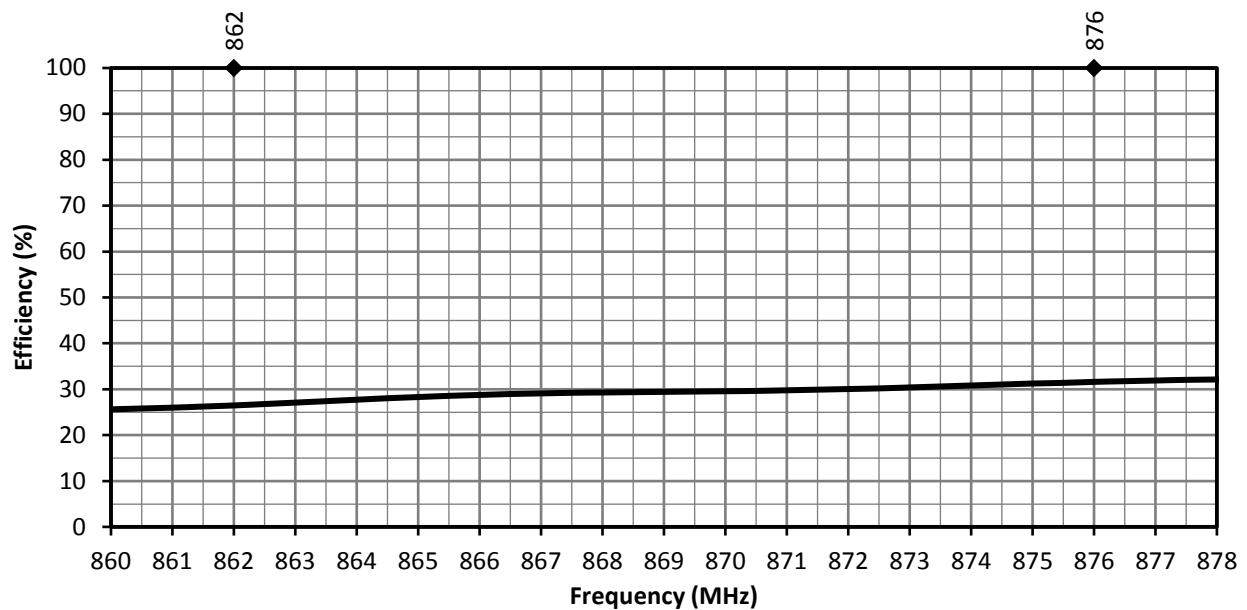

Figure 15. Antenna Radiation Efficiency for ANT-868-NUB-ccc Antenna in Free Space

RADIATION PATTERNS

Radiation patterns provide information about the directionality and 3-dimensional gain performance of the antenna by plotting gain at specific frequencies in three orthogonal planes. Antenna radiation patterns (Figure 16), are shown using polar plots covering 360 degrees. The antenna graphic above the plots provides reference to the plane of the column of plots below it. Note: when viewed with typical PDF viewing software, zooming into radiation patterns is possible to reveal fine detail.

RADIATION PATTERNS - FREE SPACE (NO GROUND PLANE)



862 MHz TO 876 MHz (868 MHz)

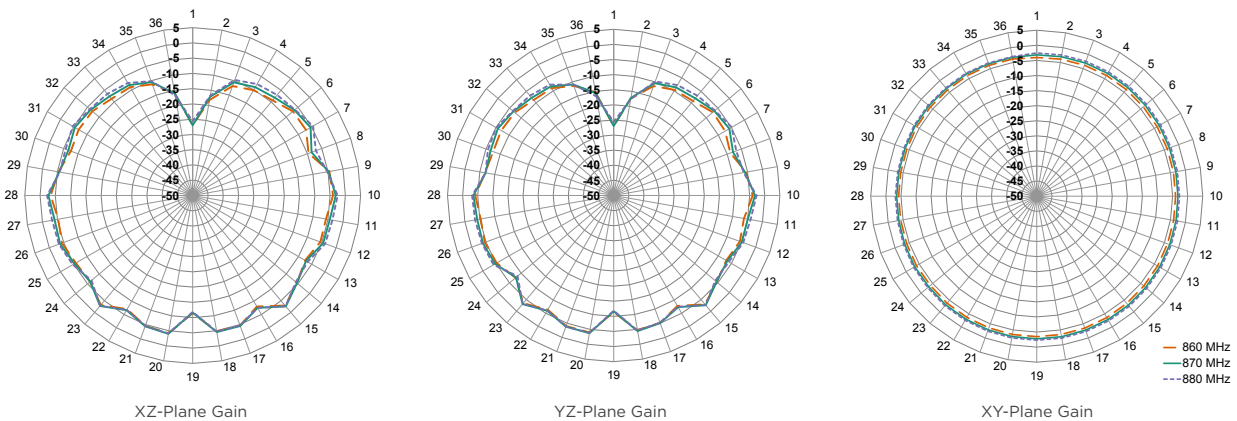

Figure 16. Radiation Patterns for ANT-868-NUB-ccc Antenna in Free Space