

## ANT-GNRM-L125A Series L1/L2/L5 Magnetic Mount Active GNSS Antennas

The GNRM-L125A is a magnetic-mount global navigation satellite system (GNSS) antenna with integrated low noise amplifier (LNA), supporting GPS, Galileo, GLONASS, Beidou, NavIC and QZSS systems in the L1/E1/B1, L2/E5/B2B and L5/E5/B2A bands. The LNA provides high gain with a low noise figure. The antenna terminates in an SMA plug (male pin) connector on 1 meter, 3 meter or 5 meter lengths of RG-174/U coaxial cable.



### Features

- Performance at 1575.42 MHz
  - VSWR:  $\leq 1.2$
  - Peak Gain: 31.7 dBi
  - Axial Ratio: 1.0 dB
- Performance at 1176.45 MHz
  - VSWR:  $\leq 1.4$
  - Peak Gain: 29.8 dBi
  - Axial Ratio: 2.5 dB
- 27 dB (Typ.) LNA
- Ground plane independent
- Right-hand circularly polarized (RHCP)
- Mounts to metal surfaces using integrated magnetic base

### Applications

- Global navigation
  - GPS L1C, L1C/A, L2, L5
  - Galileo E1, E5A, E5B
  - GLONASS L1, L2, L3
  - Beidou B1I, B1C, B2A, B2B
  - NavIC
  - QZSS L1, L2C, L5
- Timing solutions

### Ordering Information

Part Number	Description
ANT-GNRM-L125A-1	GNSS L1/L2/L5 band magnetic-mount antenna with SMA plug (male pin) connector on 1 meter of RG-174/U coaxial cable
ANT-GNRM-L125A-3	GNSS L1/L2/L5 band magnetic-mount antenna with SMA plug (male pin) connector on 3 meters of RG-174/U coaxial cable
ANT-GNRM-L125A-5	GNSS L1/L2/L5 band magnetic-mount antenna with SMA plug (male pin) connector on 5 meters of RG-174/U coaxial cable

Available from Linx Technologies and select distributors and representatives.

**Table 1. Electrical Specifications, Antenna Plus LNA**

Frequency	GPS Bands	VSWR (max.)	Return Loss (dB)	Peak Gain (dBi)	Axial Ratio (dB)
1176 MHz	GPS L5, Galileo E5A, Beidou B2A, NavIC L5, QZSS L5	1.4	-15.7	29.8	2.5
1202/1207 MHz	Galileo E5B, Beidou B2B, GLONASS L3	1.6	-12.4	31.5	2.4
1228 MHz	GPS L2, QZSS L2	1.6	-12.4	31.0	0.9
1246/1248 MHz	GLONASS L2	1.5	-13.8	23.3	1.0
1561 MHz	Beidou B1I	1.2	-21.8	30.7	0.7
1575 MHz	GPS L1C, GPS L1C/A, Galileo E1, Beidou B1C, QZSS L1	1.2	-21.8	31.7	1.0
1601/1602 MHz	GLONASS L1	1.3	-18.4	30.6	2.0
<b>Output Impedance</b>	50 Ω				
<b>Polarization</b>	RHCP				
<b>Radiation</b>	Directional radiation pattern orthogonal to antenna surface				
<b>Electrical Type</b>	Radiating Patch plus LNA				
<b>Input Voltage</b>	Min. 2.5 V, Typ. 3.0 V, Max. 5.5 V				
<b>Current Consumption @3.0V</b>	Typ. 13.0 mA, Max. 20.0 mA				
<b>Noise Figure (dB)</b>	2.1 (1561 MHz), 2.1 (1575.42 MHz), 2.2 (1602 MHz), 2.4 (1227.6 MHz), 2.1 (1176.45 MHz)				
<b>ESD Sensitivity</b>	Low ESD sensitivity. As a best practice, Linx may use ESD packaging.				

Electrical specifications and plots measured with a 102 mm x 102 mm (4.0 in x 4.0 in) metal plate.

**Table 2. Mechanical Specifications, Antenna Plus LNA**

Part Number	Connection	Coaxial Cable, minimum inside bend radius	Weight
ANT-GNRM-L125A-1	SMA plug (male pin)	RG-174/U: 10.2 mm (0.40 in),	1 meter = 214.6 g (7.57 oz)
ANT-GNRM-L125A-3	SMA plug (male pin)	RG-174/U: 10.2 mm (0.40 in),	3 meters = 241.4 g (8.51 oz)
ANT-GNRM-L125A-5	SMA plug (male pin)	RG-174/U: 10.2 mm (0.40 in),	5 meters = 268.2 g (9.46 oz)
<b>Operating Temp. Range</b>	-40 °C to +85 °C		
<b>Storage Temp. Range</b>	-40 °C to +90 °C		
<b>Dimensions</b>	Height: 22.0 mm (0.87 in) Diameter: 70.0 mm (2.76 in)		

## Ground Plane Independent Operation

Because of the significant signal gain provided by the antenna's LNA, the ground plane typically required for passive GNSS antenna gain performance is not required for active GNSS antennas.

## Mounting

The ANT-GNRM-L125A series antenna has an integrated magnetic base which mounts securely to ferrous metallic surfaces. The antenna should be mounted in a location that is not obstructed by other metallic surfaces which could interfere with signal transmission and reception. The magnetic base allows for the antenna to be repositioned as needed.

## Packaging Information

The ANT-GNRM-L125A series antenna is packaged in cartons of 100 pcs. Distribution channels may offer alternative packaging options.

Product Dimensions

Figure 1 provides dimensions of the ANT-GNRM-L125A series antenna.

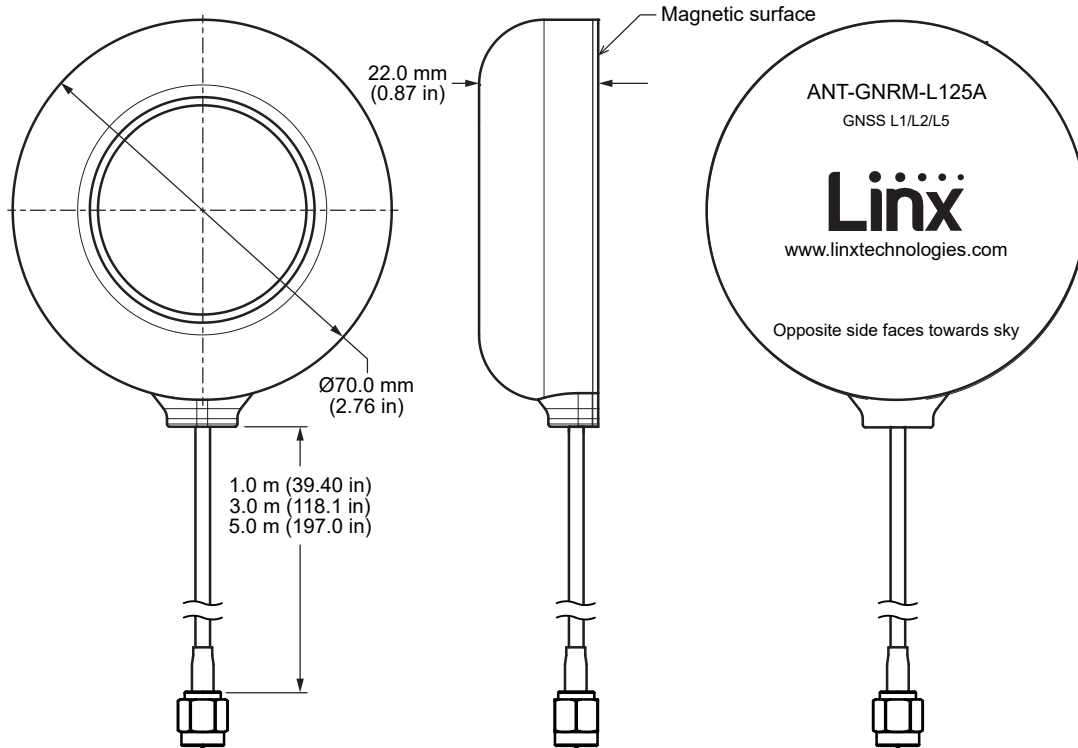

Figure 1. ANT-GNRM-L125A Series Antenna Dimensions

Antenna Orientation

The ANT-GNRM-L125A antenna is characterized on a metal plate (102 mm x 102 mm) as shown in Figure 2 providing insight into antenna performance when attached to a metal enclosure. The charts on the following pages represent data taken with the antenna oriented at the center of the metal plate.

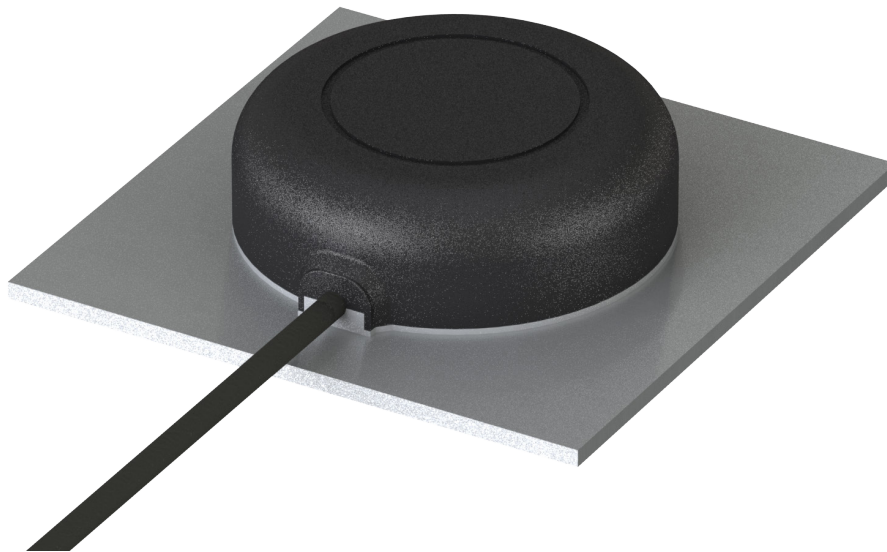

Figure 2. ANT-GNRM-L125A Test Orientation

VSWR

Figure 3 provides the voltage standing wave ratio (VSWR) across the L1 band, and Figure 4 provides VSWR across the L2 and L5 bands.

VSWR describes the power reflected from the antenna back to the radio. A lower VSWR value indicates better antenna performance at a given frequency. Reflected power is also shown on the right-side vertical axis as a gauge of the percentage of transmitter power reflected back from the antenna.

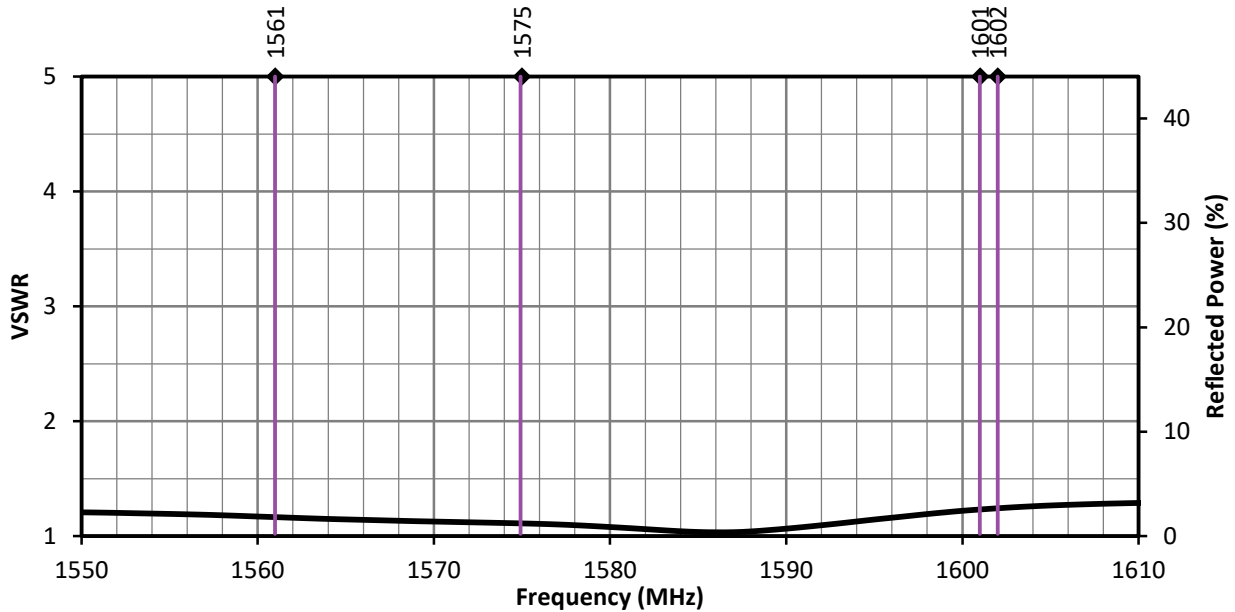

Figure 3. ANT-GCRM-L125A VSWR, L1 Band

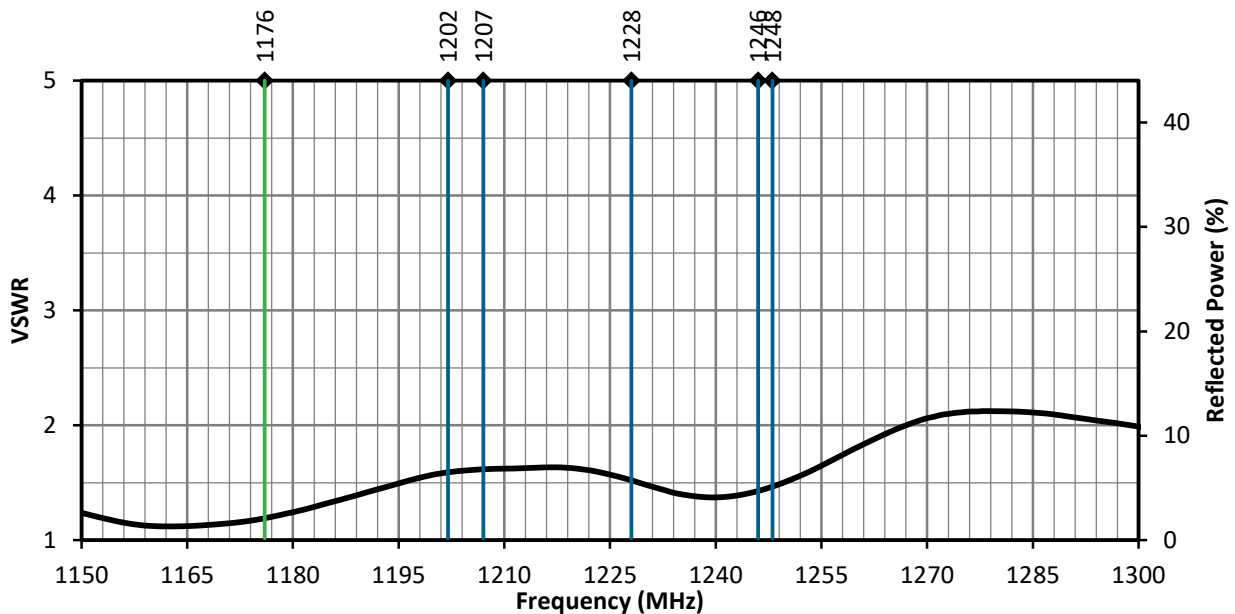

Figure 4. ANT-GCRM-L125A VSWR, L2 and L5 Bands

Return Loss

Return loss, shown in Figure 5, (L1 band) and Figure 6 (L2 and L5 band) represents the loss in power at the antenna due to reflected signals. Like VSWR, a lower return loss value indicates better antenna performance at a given frequency.

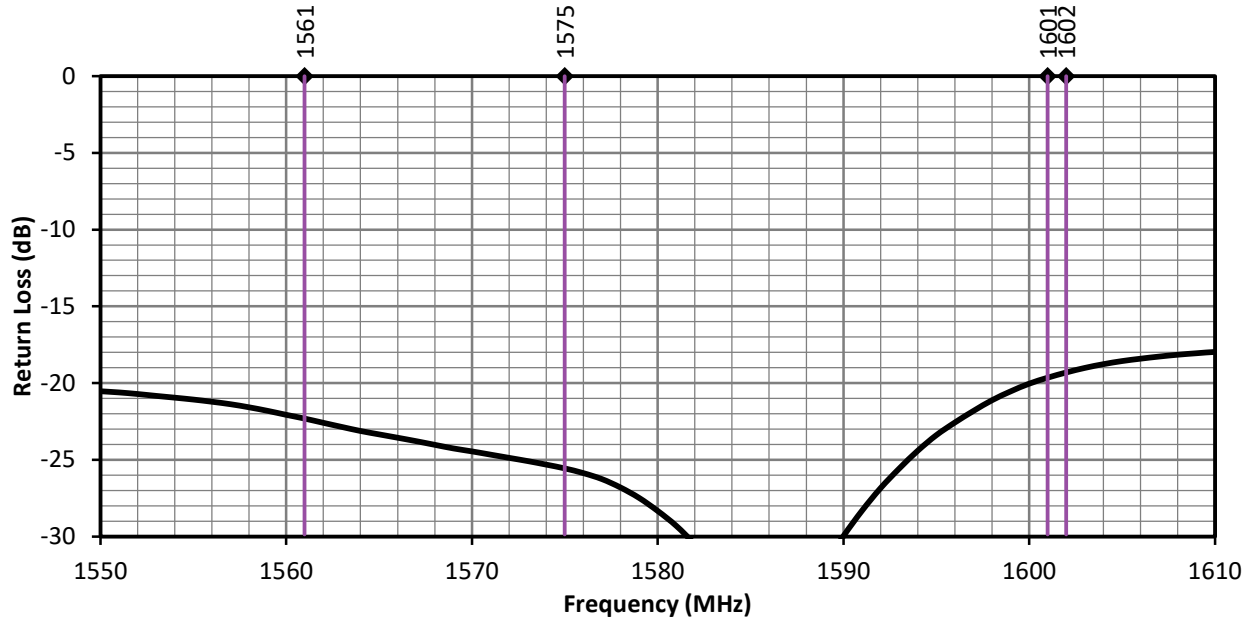

Figure 5. ANT-GCRM-L125A Return Loss, L1 Band

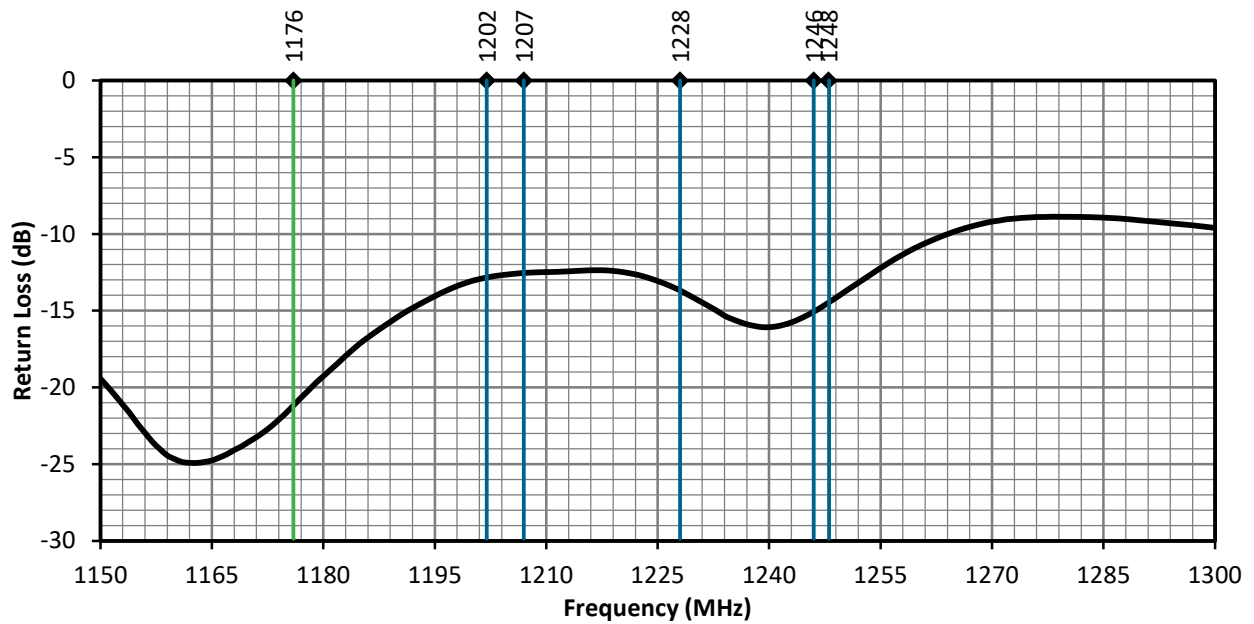

Figure 6. ANT-GCRM-L125A Return Loss, L2 and L5 Bands

**Peak Gain**

The peak gain across the antenna bandwidth is shown in Figure 7 (L1 band) and Figure 8 (L2 and L5 bands). Peak gain represents the maximum antenna input power concentration across 3-dimensional space, and therefore peak performance at a given frequency, but does not consider any directionality in the gain pattern.

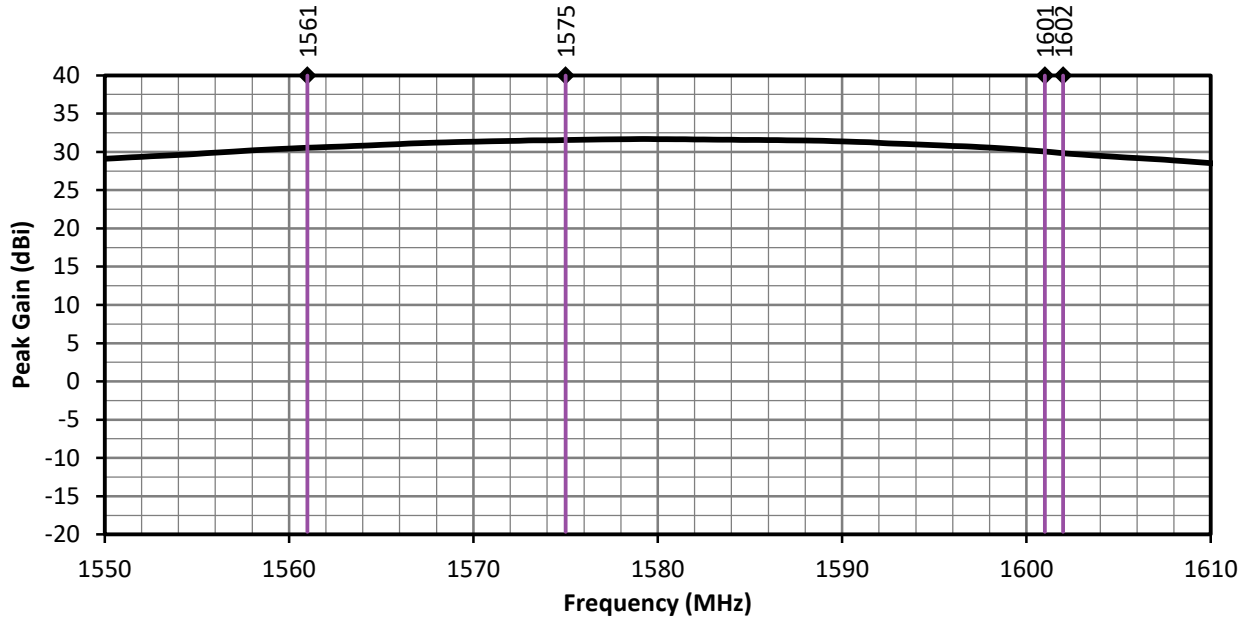

Figure 7. ANT-GNRM-L125A Peak Gain, L1 Band

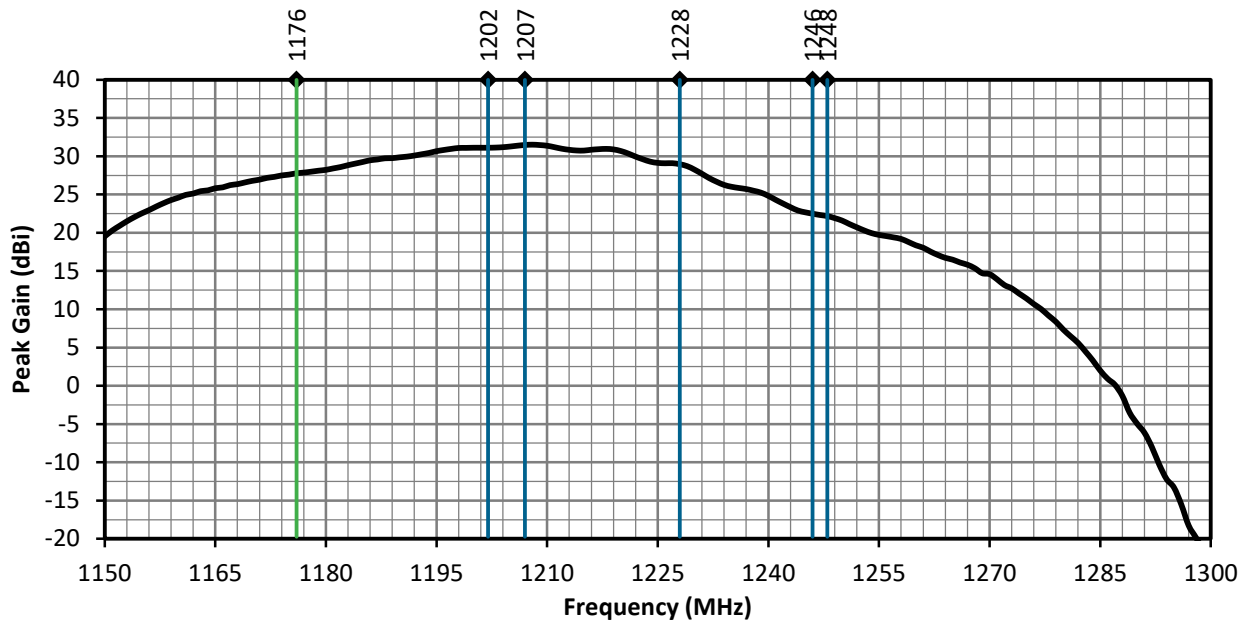

Figure 8. ANT-GNRM-L125A Peak Gain, L2 and L5 Bands

Axial Ratio

Axial ratio provides a measure of the quality of circular polarization of an antenna, the lower the value (in dB), the better the circular polarization. A circularly polarized antenna field comprises two orthogonal E-field components. These fields are ideally of equal amplitude, resulting in an axial ratio equal to unity (0 dB). In practice, no antenna is perfectly circular in polarization, the polarization is elliptical as one field has larger magnitude. As the axial ratio increases the antenna gain degrades away from the main beam orthogonal to the antenna surface. The axial ratio for the ANT-GCRM-L125A antenna is shown in Figure 9 (L1 band) and Figure 10 (L2 and L5 bands).

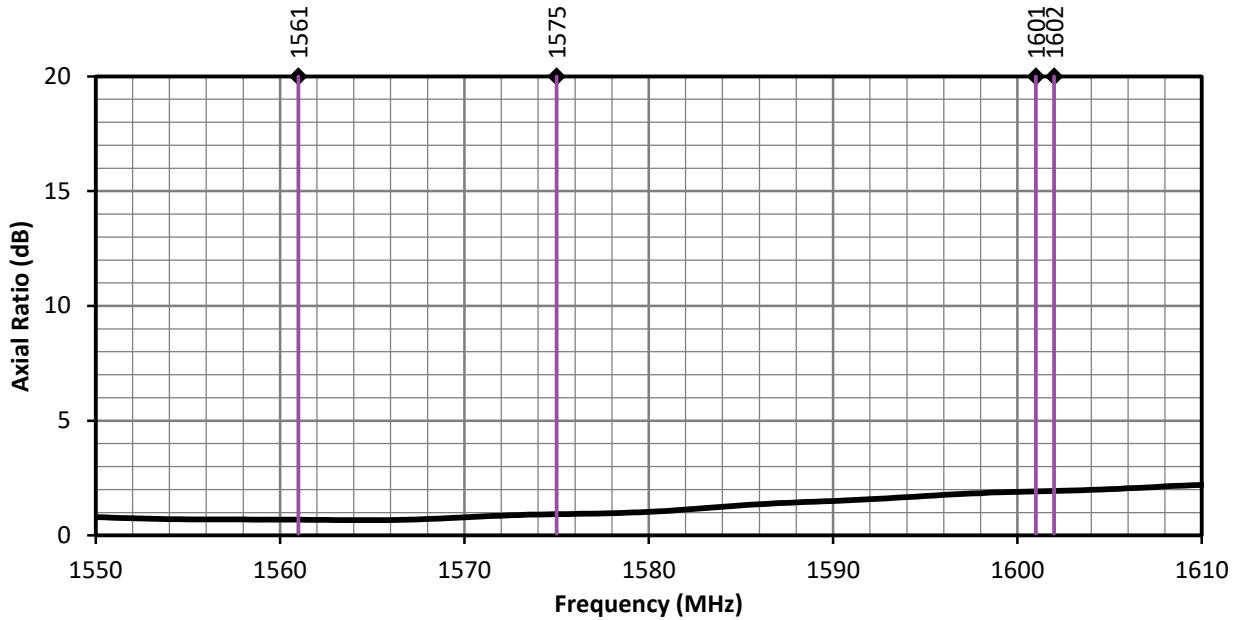

Figure 9. ANT-GCRM-L125A Antenna Axial Ratio, L1 Band

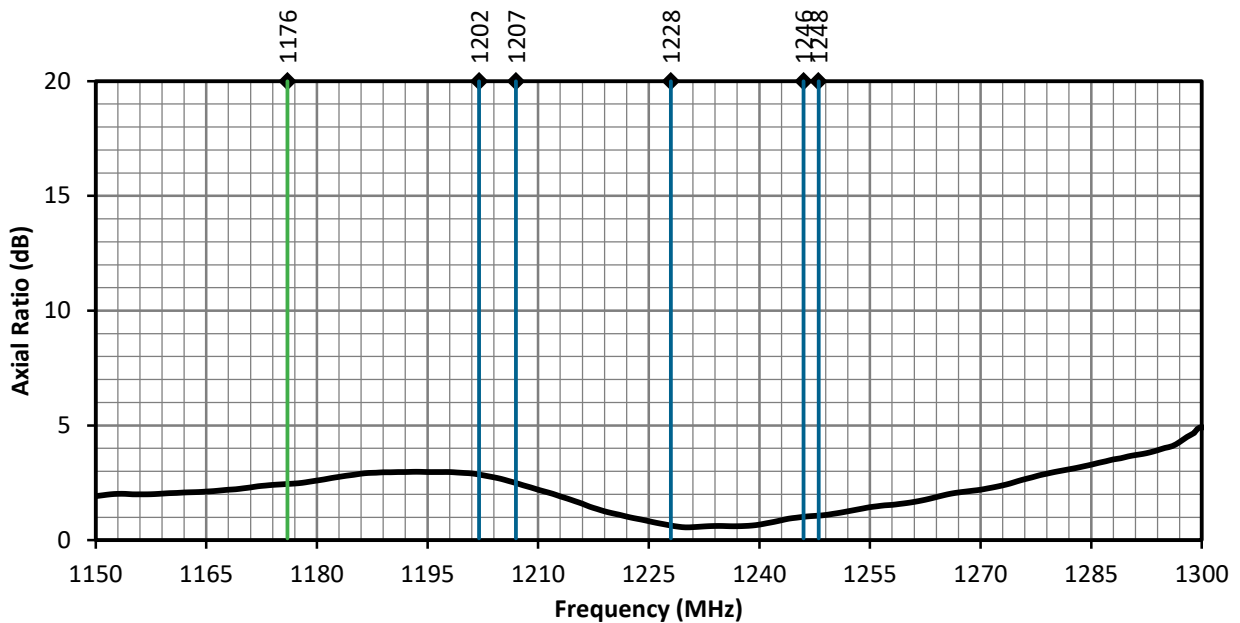
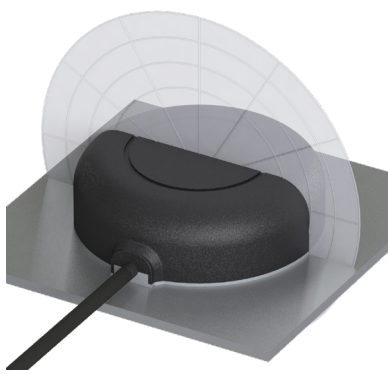

Figure 10. ANT-GCRM-L125A Antenna Axial Ratio, L2 and L5 Bands

**Radiation Patterns**

Radiation patterns provide information about the directionality and 3-dimensional gain performance of the antenna by plotting gain at specific frequencies in three orthogonal planes. Antenna radiation patterns are shown in Figure 11 using polar plots covering 360 degrees. The antenna graphic at the top of the page provides reference to the plane of the column of plots below it. Note: when viewed with typical PDF viewing software, zooming into radiation patterns is possible to reveal fine detail.



XZ-Plane Gain

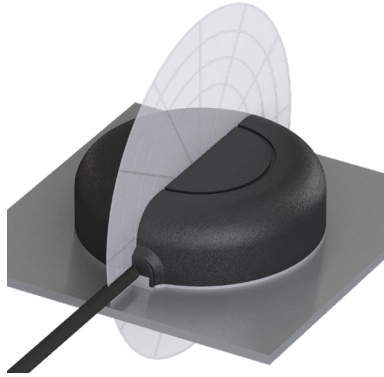

YZ-Plane Gain

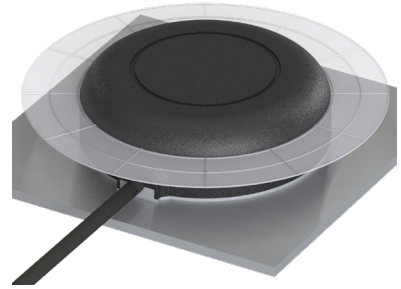

XY-Plane Gain

**1164 MHz to 1189 MHz (1176 MHz)**

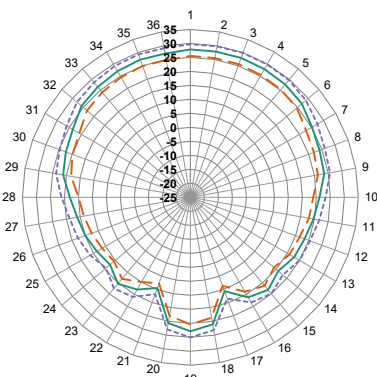

XZ-Plane Gain

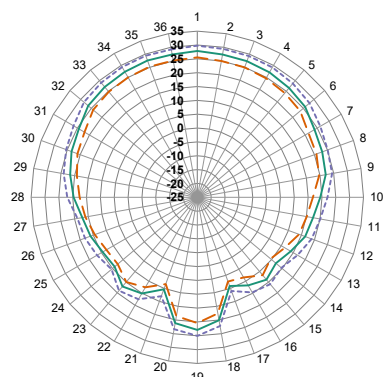

YZ-Plane Gain

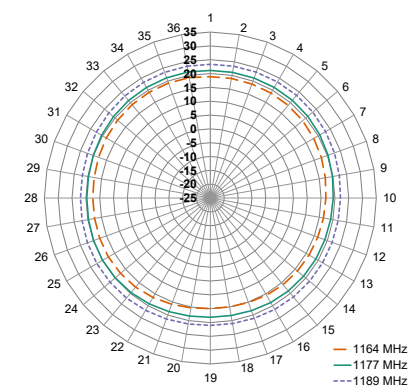

XY-Plane Gain

— 1164 MHz  
— 1176 MHz  
- - 1189 MHz

**1197 MHz to 1218 MHz (1202 MHz)**

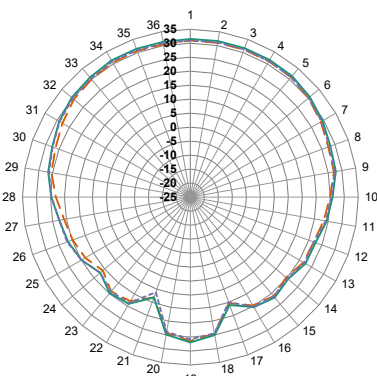

XZ-Plane Gain

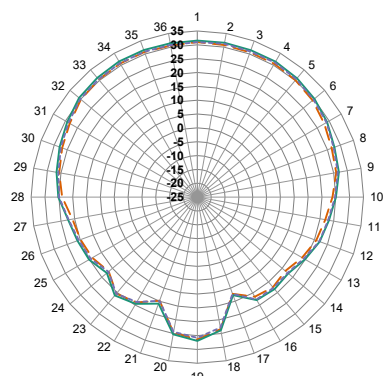

YZ-Plane Gain

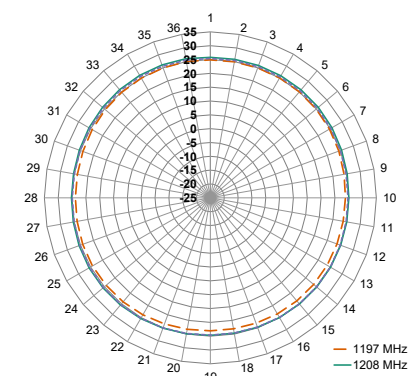

XY-Plane Gain

— 1197 MHz  
— 1202 MHz  
- - 1218 MHz



Radiation Patterns

1215 MHz to 1240 MHz (1228 MHz)

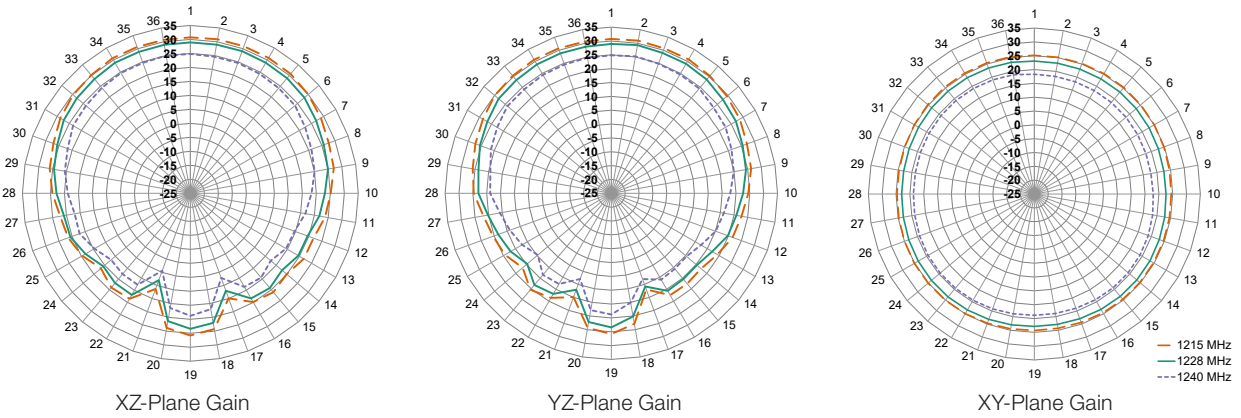

1243 MHz to 1250 MHz (1248 MHz)

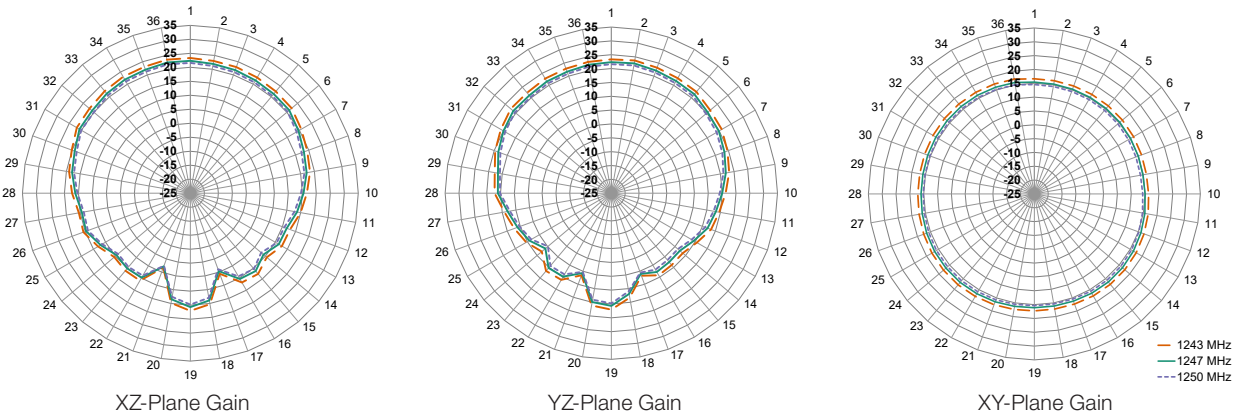

1559 MHz to 1563 MHz (1561 MHz)

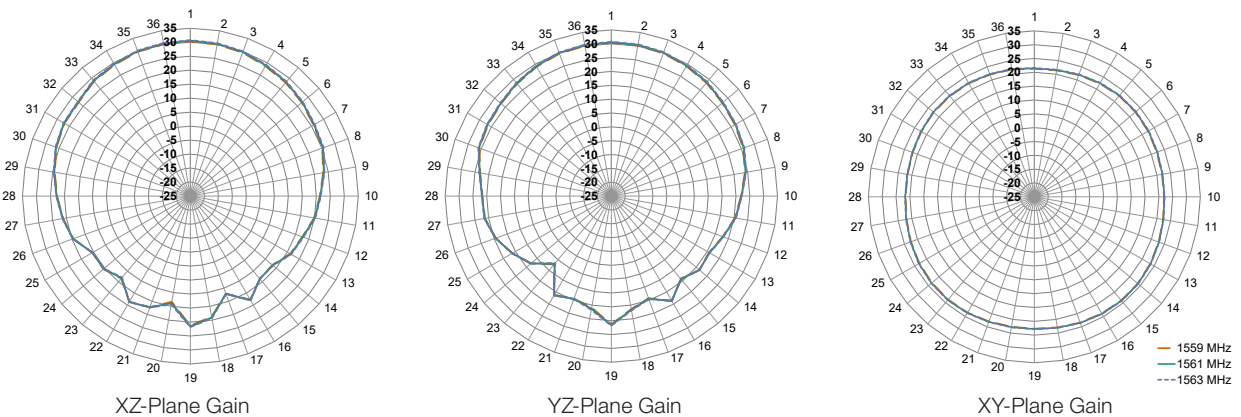

Radiation Patterns

1559 MHz to 1592 MHz (1575 MHz)

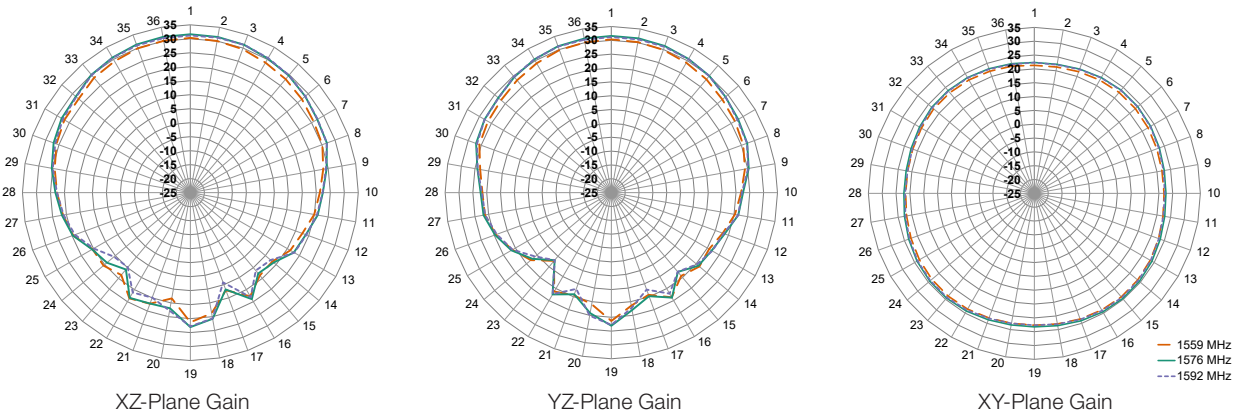

1598 MHz to 1606 MHz (1601 MHz)

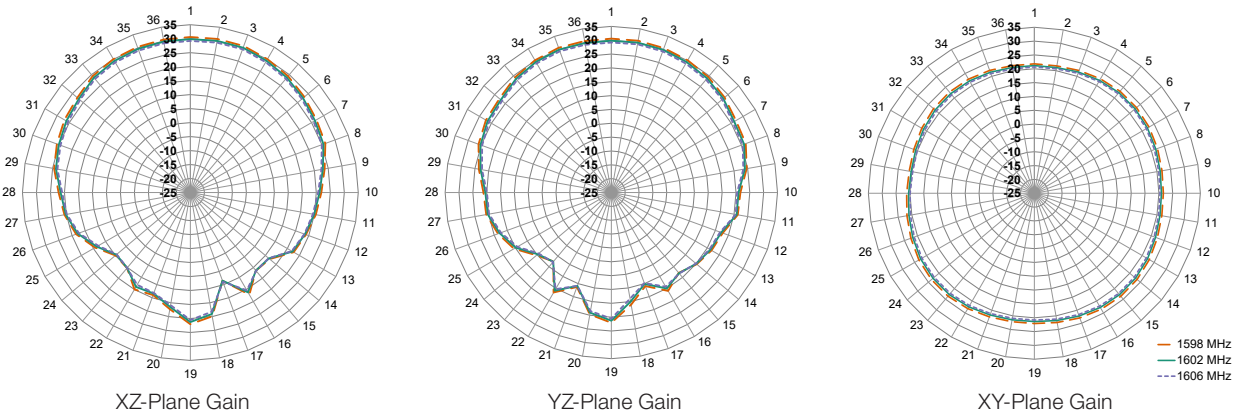

Figure 11. ANT-GCRM-L125A Radiation Patterns

**Antenna Definitions and Useful Formulas**

**VSWR** - Voltage Standing Wave Ratio. VSWR is a unitless ratio that describes the power reflected from the antenna back to the radio. A lower VSWR value indicates better antenna performance at a given frequency. VSWR is easily derived from Return Loss.

$$VSWR = \frac{10^{\left[\frac{\text{Return Loss}}{20}\right]} + 1}{10^{\left[\frac{\text{Return Loss}}{20}\right]} - 1}$$

**Return Loss** - Return loss represents the loss in power at the antenna due to reflected signals, measured in decibels. A lower return loss value indicates better antenna performance at a given frequency. Return Loss is easily derived from VSWR.

$$\text{Return Loss} = -20 \log_{10} \left[ \frac{VSWR - 1}{VSWR + 1} \right]$$

**Efficiency (η)** - The total power radiated from an antenna divided by the input power at the feed point of the antenna as a percentage.

**Total Radiated Efficiency** - (TRE) The total efficiency of an antenna solution comprising the radiation efficiency of the antenna and the transmitted (forward) efficiency from the transmitter.

$$TRE = \eta \cdot \left( 1 - \left( \frac{VSWR - 1}{VSWR + 1} \right)^2 \right)$$

**Gain** - The ratio of an antenna’s efficiency in a given direction (G) to the power produced by a theoretical lossless (100% efficient) isotropic antenna. The gain of an antenna is almost always expressed in decibels.

$$G_{db} = 10 \log_{10}(G)$$

$$G_{dBd} = G_{dBi} - 2.51dB$$

**Peak Gain** - The highest antenna gain across all directions for a given frequency range. A directional antenna will have a very high peak gain compared to average gain.

**Average Gain** - The average gain across all directions for a given frequency range.

**Maximum Power** - The maximum signal power which may be applied to an antenna feed point, typically measured in watts (W).

**Reflected Power** - A portion of the forward power reflected back toward the amplifier due to a mismatch at the antenna port.

$$\left( \frac{VSWR - 1}{VSWR + 1} \right)^2$$

**decibel (dB)** - A logarithmic unit of measure of the power of an electrical signal.

**decibel isotropic (dBi)** - A comparative measure in decibels between an antenna under test and an isotropic radiator.

**decibel relative to a dipole (dBd)** - A comparative measure in decibels between an antenna under test and an ideal half-wave dipole.

**Dipole** - An ideal dipole comprises a straight electrical conductor measuring 1/2 wavelength from end to end connected at the center to a feed point for the radio.

**Isotropic Radiator** - A theoretical antenna which radiates energy equally in all directions as a perfect sphere.

**Omnidirectional** - Term describing an antenna radiation pattern that is uniform in all directions. An isotropic antenna is the theoretical perfect omnidirectional antenna. An ideal dipole antenna has a donut-shaped radiation pattern and other practical antenna implementations will have less perfect but generally omnidirectional radiation patterns which are typically plotted on three axes.