

## SPECIFICATION

Part No.	:	<b>AP.17F.07.0064A</b>
Product Name	:	17mm Two Stage GPS/GALILEO Active Patch Antenna Module
Features	:	22.2mm*23.8mm*7.8mm 64mm 1.13 IPEX MHFI Wide Voltage Input 1.8V to 5.5V 28dB LNA Tested in Free space RoHS Compliant

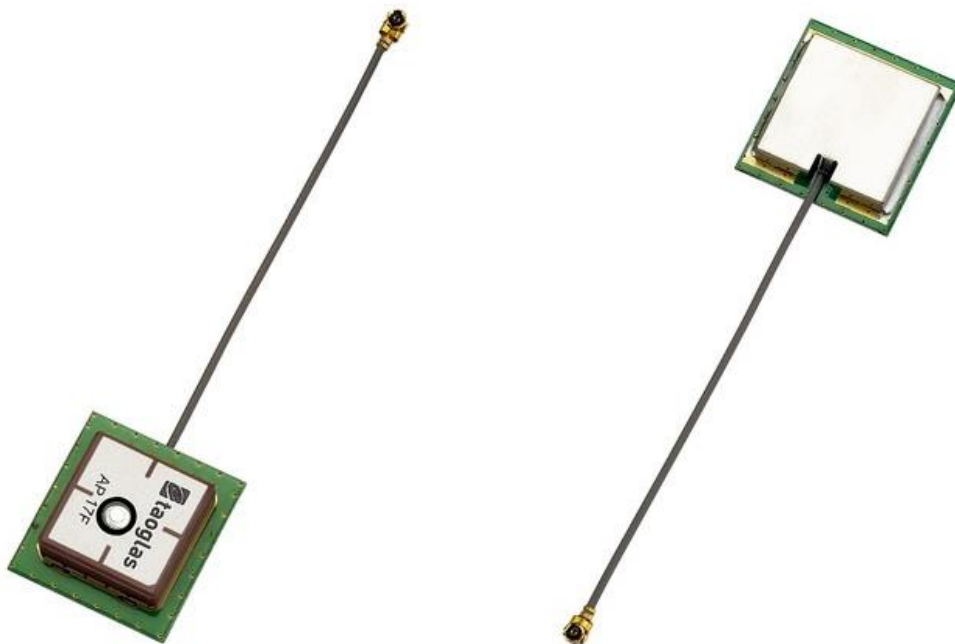

## 1. Introduction

The AP.17F is a two stage 17mm active patch antenna that has been designed specifically for embedded (inside device) integration with GPS/GALILEO receiver modules.

The AP.17F combines a 17\*17\*4mm advanced low profile ceramic patch antenna with a one stage LNA and a front-end SAW filter with ultra thin coaxial cable. It comes with it's own integrated ground-plane. The front end SAW filter reduces the risks where there is a cellular transmitter nearby of interference from out of band frequencies which can cause LNA burn-out, saturation, or radiated spurious emissions.

The antenna can work on a wide input voltage from 1.8V to 5.5V with best in class power consumption figures.

If further tuning and optimization specific to a customer device is required Taoglas offers a custom tuned and optimized part service. Contact [sales@taoglas.com](mailto:sales@taoglas.com) for more information.

Cables and connectors can be customized according to request.

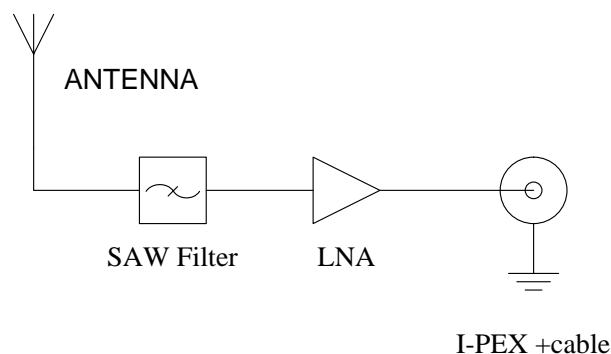

## 2. Specifications

ELECTRICAL			
Input Voltage	Min:1.8V Typ.: 3.0V Max: 5.5V		
Frequency Range	1575.42MHz +/- 1.023 MHz		
Gain	-1.5dBic Typ. @zenith		
Polarization	RHCP		
Axial ratio	Max 3.0dB@zenith		
Frequency Range	1575.42MHz +/- 1.023 MHz		
Gain (With LNA)	At 90°	At 5.5V	22.5 ± 3dBic
		At 3.0V	29.5 ± 3dBic
		At 1.8V	32.5 ± 3dBic
Output Impedance	50Ω		
LNA			
Frequency	1575.42 ± 1.023MHz		
Outer Band Attenuation	F0=1575.42MHz		
	F0±30MHz	6dB min.	
	F0±50MHz	20dB min.	
	F0±100MHz	25dB min.	
Output Impedance	50Ω		
Output VSWR	2.0 Max		
Pout at 1dB Gain	Typ. -5dBm		
Compression point	Min. -9dBm		
LNA Gain, Power Consumption and Noise Figure			
Voltage	LNA Gain (Typ)	Power Consumption (mA) Typ	Noise Figure Typ
Min. 1.8V	21dB	3.3mA	2.7dB
Typ. 3.0V	28dB	7.5mA	2.5dB
Max. 5.5V	31dB	15.5mA	2.7dB

MECHANICAL	
RF Cable	Ø1.13 RF Coaxial Cable L=64mm±1.5mm
RF Connector	I-PEX(MHF) - U.FL Comp.
Dimensions	22.2mm*23.8mm*7.8mm
ENVIRONMENTAL	
Operation Temperature	-40°C to + 85°C
Storage Temperature	-40°C to + 85°C
Relative Humidity	40% to 95%

## 2.1. LNA Gain and Out Band Rejection @3.0V

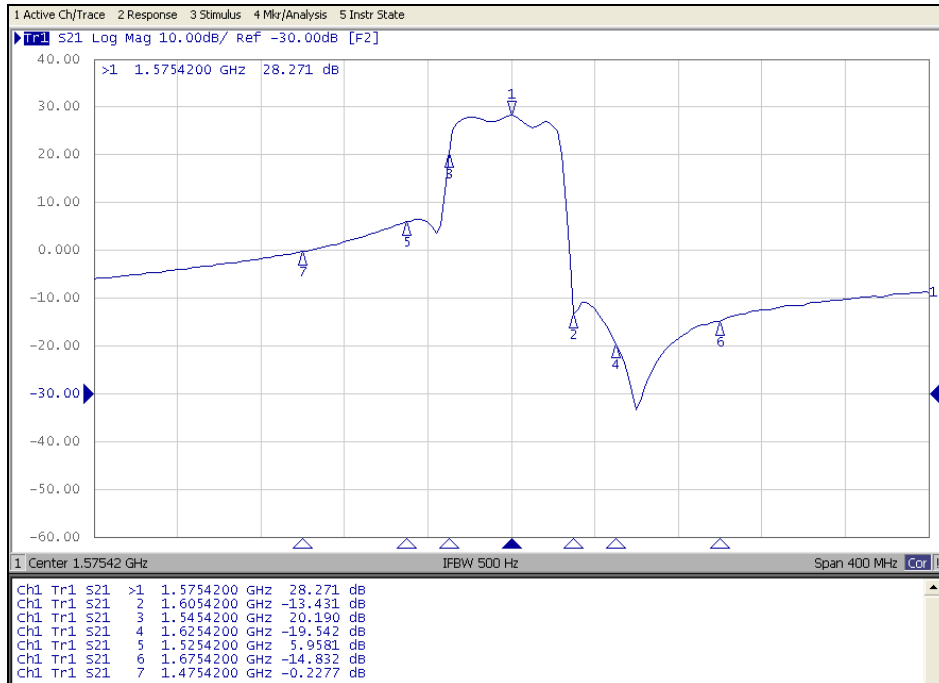

## 2.2. LNA Noise Figure @3.0V

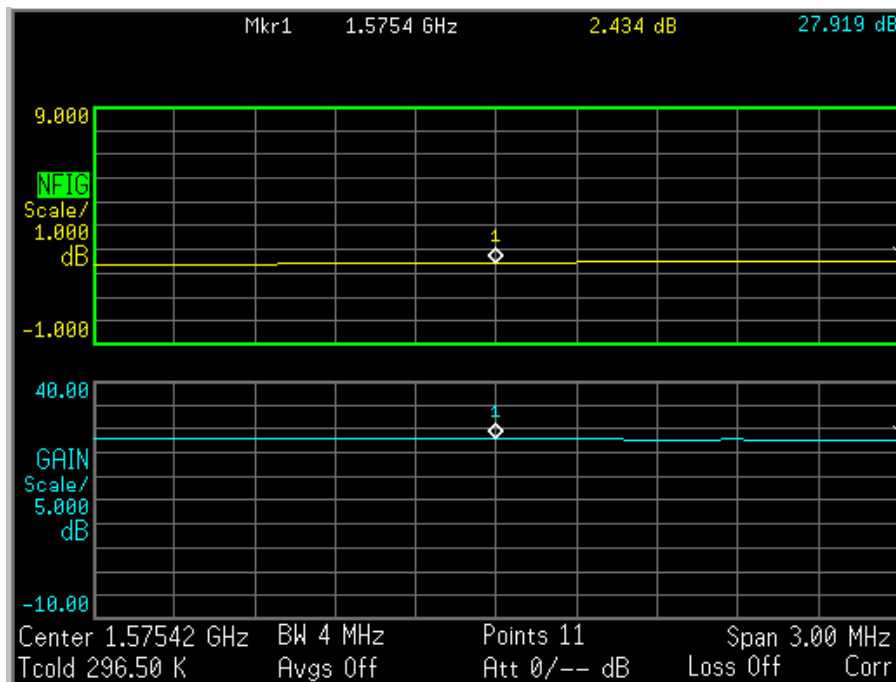

### 3. Radiation Patterns

XY Plane

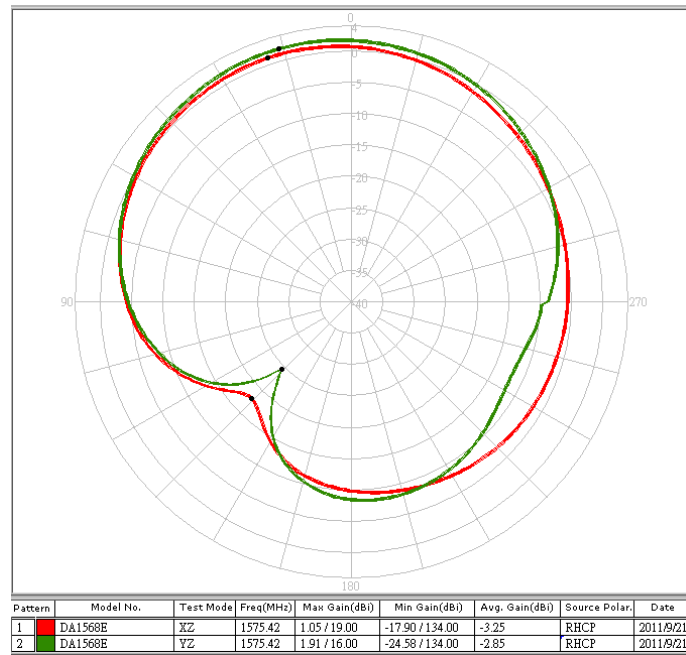

XZ Plane

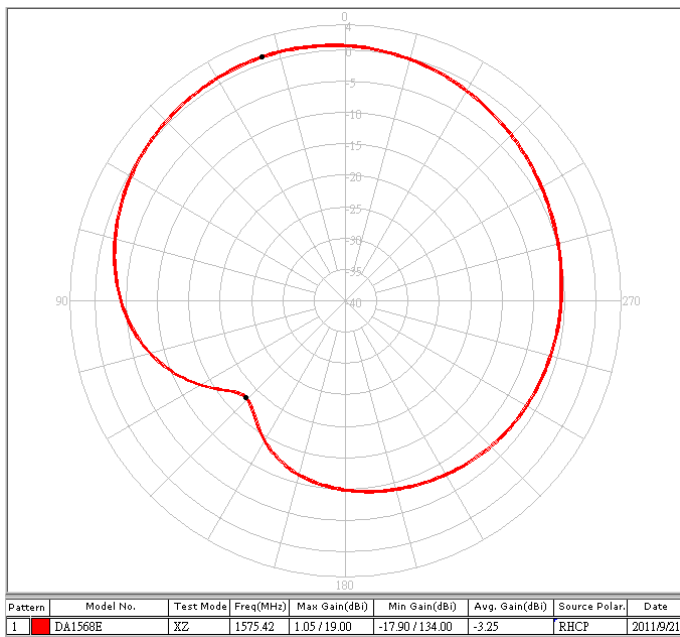

YZ Plane

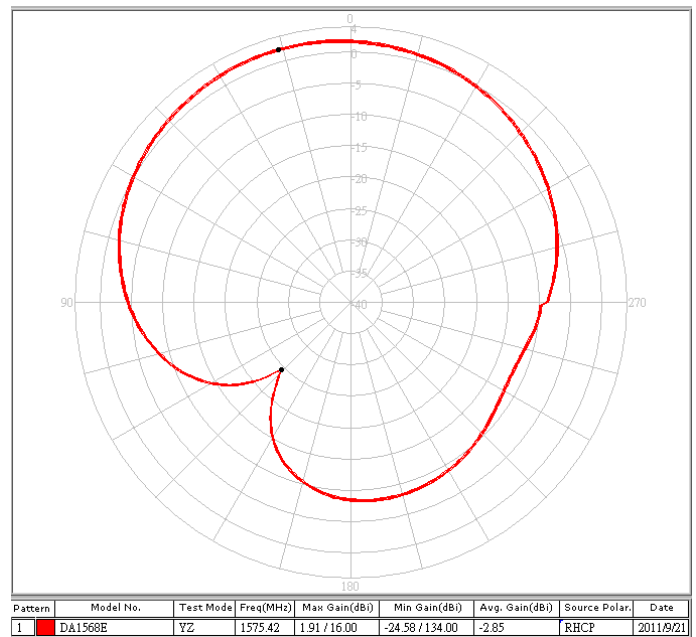

## 4. Plugs Usage Precautions

### 4.1. Mating / Unmating

(1) To disconnect connectors, insert the end portion of I-PEX under the connector flanges and pull off vertically, in the direction of the connector mating axis.

(2) To mate the connectors, the mating axes of both connectors must be aligned and the connectors can be mated. The "click" will confirm fully mated connection. Do not attempt to insert on an extreme angle.

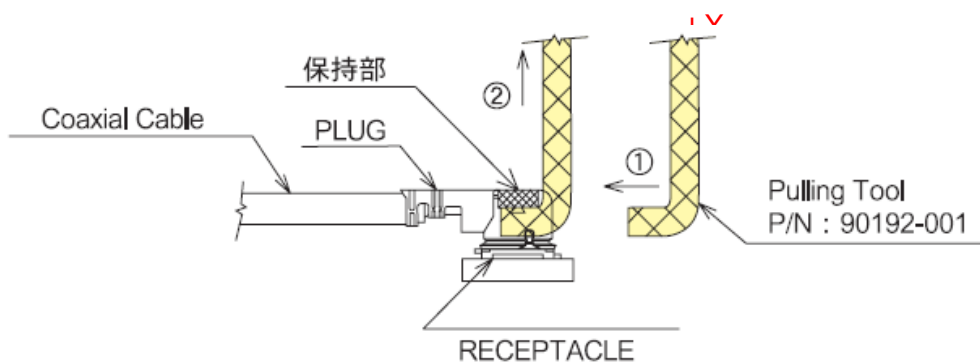

### 4.2. Pull forces on the cable after connectors are mated

After the connectors are mated, do not apply a load to the cable in excess of the values indicated in the diagram below.

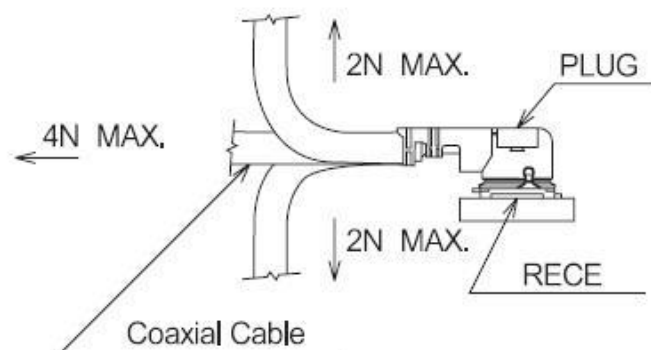

## 5. Mechanical Drawing (Unit: mm)

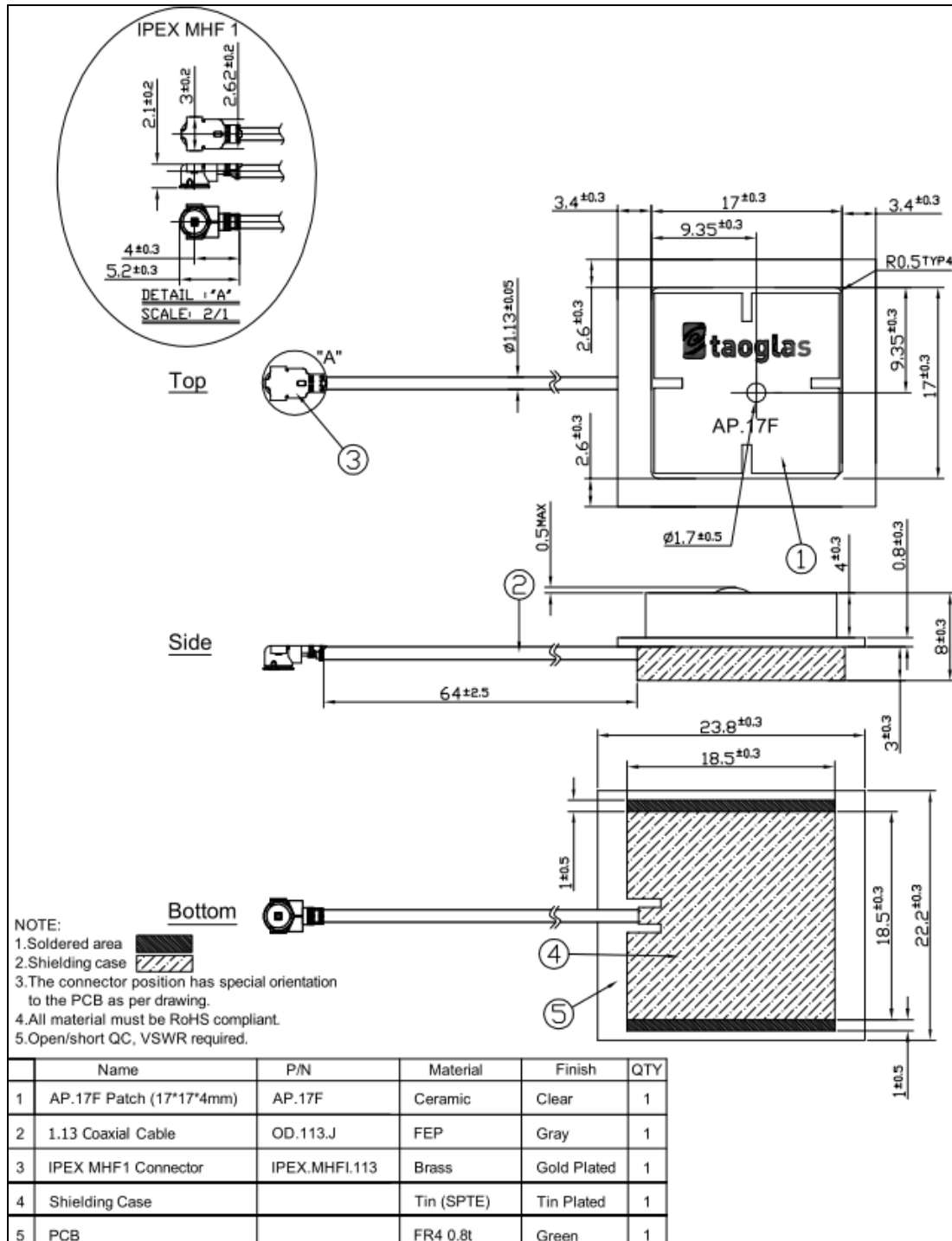



## 6. Packaging

60 pc AP.17E.07.0064A in Vacuum Bag  
 Dimensions - 500\*395mm  
 Weight - 650Kg

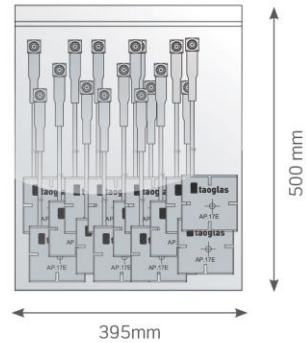

Batch of 2, 120pc AP.17E.07.0064A in Vacuum Bags  
 Dimensions - 500\*395mm  
 Weight - 1.3Kg

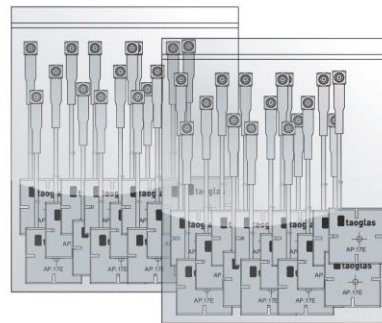

10 Vacuum Bags  
 600 pcs in one carton  
 Carton Dimensions - 390\*320\*290mm  
 Weight - 6.3Kg

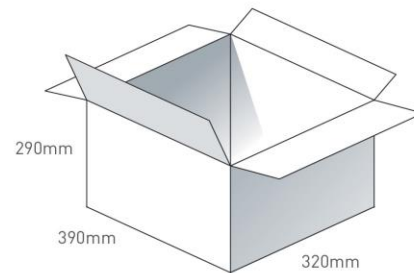

Pallet Dimensions 1200\*1000\*1360mm  
 36 Cartons per Pallet  
 9 Cartons per layer  
 4 Layers

