

## Description

The AP7315 is a low dropout regulator with high output voltage accuracy, low  $R_{DS(ON)}$ , high PSRR, low output noise and low quiescent current. This regulator is based on a CMOS process.

The AP7315 includes a voltage reference, error amplifier, current limit circuit and an enable input to turn it on and off. With the integrated resistor network fixed output voltage versions can be delivered.

With its low power consumption and line and load transient response, the AP7315 is well suited for low power handheld communication equipment.

The AP7315 is packaged in X2-DFN1010-4, SOT23 and SOT25 packages and allows for smallest footprint and dense PCB layout.

## Features

- Low  $V_{IN}$  and Wide  $V_{IN}$  Range: 1.7V to 5.25V
- Guarantee Output Current, 150mA
- $V_{OUT}$  Accuracy  $\pm 1\%$
- Ripple Rejection 75dB at 1kHz
- Low Output Noise, 60 $\mu$ Vrms from 10Hz to 100kHz
- Quiescent Current as Low as 35 $\mu$ A
- $V_{OUT}$  Fixed 1.1V to 3.3V
- **Totally Lead-Free & Fully RoHS Compliant (Notes 1 & 2)**
- **Halogen and Antimony Free, Green Device (Note 3)**

## Applications

- Smart Phone/PAD
- RF Supply
- Cameras
- Portable Video
- Portable Media Player
- Wireless Adapter
- Wireless Communication

## Pin Assignments



**Top View**    **X2-DFN1010-4**    **Bottom View**

Pin 1 –  $V_{OUT}$ , Pin 2 – GND, Pin 3 – EN, Pin 4 –  $V_{IN}$

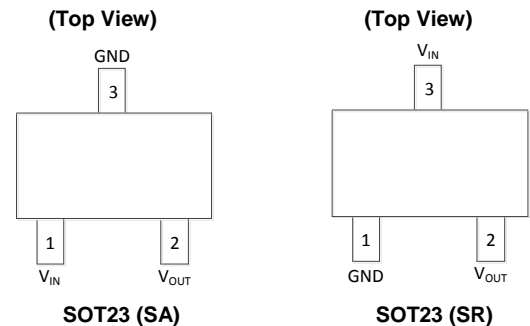

**SOT23 (SA)**

**SOT23 (SR)**



**SOT25**

- Notes:
1. No purposely added lead. Fully EU Directive 2002/95/EC (RoHS) & 2011/65/EU (RoHS 2) compliant.
  2. See [http://www.diodes.com/quality/lead\\_free.html](http://www.diodes.com/quality/lead_free.html) for more information about Diodes Incorporated's definitions of Halogen- and Antimony-free, "Green" and Lead-free.
  3. Halogen- and Antimony-free "Green" products are defined as those which contain <900ppm bromine, <900ppm chlorine (<1500ppm total Br + Cl) and <1000ppm antimony compounds.

**Typical Applications Circuit**



**Pin Descriptions**

Pin Name	Pin Number				Function
	X2-DFN1010-4	SOT25	SOT23 (SA)	SOT23 (SR)	
V <sub>OUT</sub>	1	5	2	2	Power output pin
GND	2	2	3	1	Ground
EN	3	—	—	—	Enable pin. Active high
V <sub>IN</sub>	4	1	1	3	Power input pin
—	Thermal PAD	—	—	—	In PCB layout, prefer to use large copper area to cover this pad for better thermal dissipation, then connect this area to GND or leave it open. However, do not use it as GND electrode function alone.
EN/NC	—	3	—	—	Enable pin. Active high/ NC, No connection
NC	—	4	—	—	No connection

**Functional Block Diagram**



### Absolute Maximum Ratings (Note 4) (@T<sub>A</sub> = +25°C, unless otherwise specified.)

Symbol	Parameter	Ratings	Unit
V <sub>IN</sub>	Input Voltage	6.0	V
V <sub>EN</sub>	Input Voltage EN	6.0	V
V <sub>OUT</sub>	Output Voltage	-0.3 to V <sub>IN</sub> +0.3	V
I <sub>OUT</sub>	Output Current	300	mA
P <sub>D</sub>	Power Dissipation	400	mW
T <sub>A</sub>	Operating Ambient Temperature	-40 to +85	°C
T <sub>STG</sub>	Storage Temperature	-55 to +125	°C

Note: 4. a). Stresses beyond those listed under Absolute Maximum Ratings may cause permanent damage to the device. These are stress ratings only and functional operation of the device at these conditions is not implied. Exposure to absolute-maximum-rated conditions for extended periods may affect device reliability.  
 b). Ratings apply to ambient temperature at +25°C. The JEDEC High-K board design used to derive this data is a 2in. x 2in. multi-layer board with 1oz. internal power and ground planes and 2oz. copper traces on the top and bottom of the board.

### Recommended Operating Conditions (@T<sub>A</sub> = +25°C, unless otherwise specified.)

Symbol	Parameter	Min	Max	Unit
V <sub>IN</sub>	Input Voltage	1.7	5.25	V
I <sub>OUT</sub>	Output Current	0	150	mA
T <sub>A</sub>	Operating Ambient Temperature	-40	+85	°C

**Electrical Characteristics** ( $V_{EN} = V_{IN} = V_{OUT} + 1.0V$ ,  $C_{IN} = C_{OUT} = 0.47\mu F$ ,  $I_{OUT} = 1.0mA$  @  $T_A = +25^\circ C$ , unless otherwise specified.)

Parameter	Conditions	Min	Typ	Max	Units		
Input Voltage	$T_A = -40^\circ C$ to $+85^\circ C$	1.7	—	5.25	V		
Output Voltage Accuracy (Note 11)	$V_{OUT} \geq 2.0V$ , $V_{IN} = V_{OUT} + 1V$ , $T_A = +25^\circ C$	$V_{OUT} * 0.99$	$V_{OUT}$	$V_{OUT} * 1.01$	V		
	$V_{OUT} < 2.0V$ , $V_{IN} = V_{OUT} + 1V$ , $T_A = +25^\circ C$	$V_{OUT} - 20mV$	$V_{OUT}$	$V_{OUT} + 20mV$	V		
Line Regulation ( $dV_{OUT}/dV_{IN}/V_{OUT}$ )	$V_{IN} = (V_{OUT-Nom} + 1.0V)$ to $5.25V$ , $I_{OUT} = 1.0mA$	—	0.02	0.1	%/V		
Load Regulation ( $dV_{OUT}/V_{OUT}/dI_{OUT}$ )	$V_{IN} = V_{OUT-Nom} + 1.0V$ , $I_{OUT} = 1mA$ to $150mA$	—	0.5	1.0	%/A		
Quiescent Current (Note 6)	$I_{OUT} = 0mA$	20	35	60	$\mu A$		
	$I_{OUT} = 150mA$	30	60	100			
$I_{STANDBY}$	$V_{EN} = 0V$ (Disabled)	—	0.01	1.0	$\mu A$		
Output Current	—	150	—	—	mA		
Fold-back Short Current (Note 7)	$V_{OUT}$ Short to Ground	—	55	—	mA		
PSRR (Note 8)	$V_{IN} = (V_{OUT} + 1V)V_{DC} + 0.2V_{p-pAC}$ , $V_{OUT} \geq 1.8V$ , $I_{OUT} = 30mA$	f = 1kHz		—	75	—	dB
Output Noise Voltage (Notes 8, 9)	BW = 10Hz to 100kHz, $I_{OUT} = 30mA$		—	60	—	$\mu V_{rms}$	
Dropout Voltage (Note 5)	$I_{OUT} = 150mA$	$1.1V \leq V_{OUT} < 1.5V$	—	0.50	0.64	V	
		$1.5V \leq V_{OUT} < 1.7V$	—	0.38	0.49		
		$1.7V \leq V_{OUT} < 2.0V$	—	0.34	0.44		
		$2.0V \leq V_{OUT} < 2.5V$	—	0.28	0.38		
		$2.5V \leq V_{OUT} < 2.8V$	—	0.22	0.32		
		$2.8V \leq V_{OUT} \leq 3.3V$	—	0.21	0.29		
Output Voltage Temperature Coefficient	$I_{OUT} = 30mA$ , $T_A = -40^\circ C$ to $+85^\circ C$	—	$\pm 30$	—	ppm/ $^\circ C$		
EN Input Low Voltage	—	0	—	0.5	V		
EN Input High Voltage	—	1.3	—	5.25	V		
EN Input Leakage	$V_{EN} = 0$ , $V_{IN} = 5.0V$ or $V_{EN} = 5.0V$ , $V_{IN} = 0V$	-1.0	—	+1.0	$\mu A$		
On Resistance of N-channel for Auto-Discharge (Note 10)	$V_{IN} = 4.0V$ , $V_{EN} = 0V$ (Disabled)	—	30	—	$\Omega$		

- Notes:
- Dropout voltage is the voltage difference between the input and the output at which the output voltage drops 2% below its nominal value.
  - Quiescent current is defined here is the difference in current between the input and the output.
  - Short circuit current is measured with  $V_{OUT}$  pulled to GND.
  - This specification is guaranteed by design.
  - To make sure lowest environment noise minimizes the influence on noise measurement.
  - AP7315 has 2 options for output, built-in discharge and non-discharge.
  - Potential multiple grades based on following output voltage accuracy.

Typical Characteristics

NEW PRODUCT

Output Voltage vs. Output Current  
AP7315-18



Output Voltage vs. Output Current  
AP7315-25



Output Voltage vs. Output Current  
AP7315-33



Output Noise (AP7315-33)



Output Voltage vs. Input Voltage  
AP7315-25

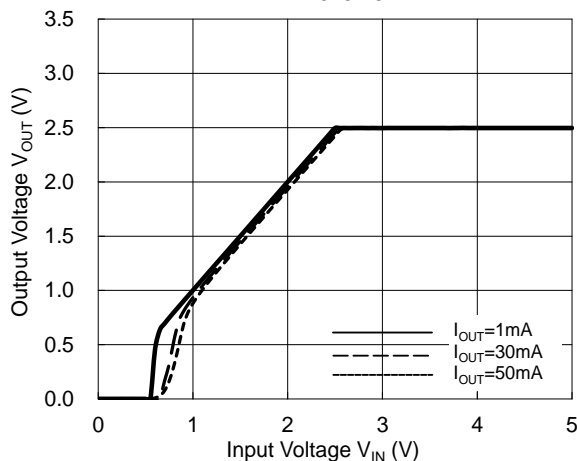

Output Voltage vs. Input Voltage  
AP7315-33

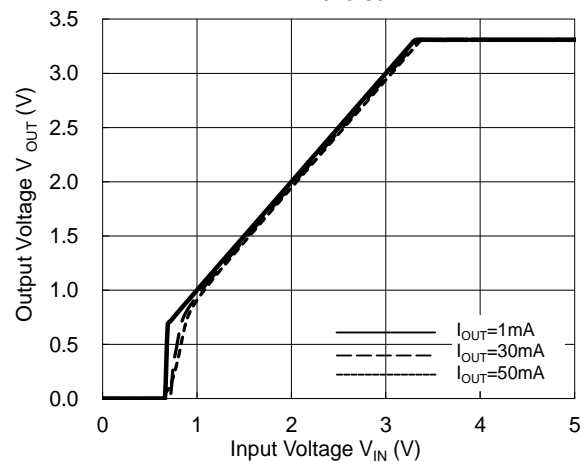

**Typical Characteristics (Cont.)**

NEW PRODUCT



**Typical Characteristics (Cont.)**

NEW PRODUCT

**Dropout Voltage vs. Output Current**  
AP7315-25

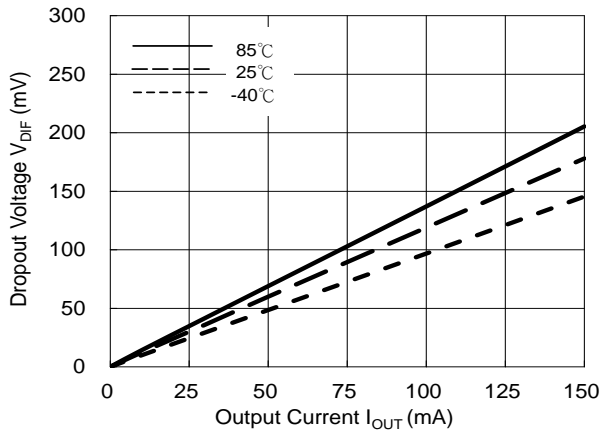

**Dropout Voltage vs. Output Current**  
AP7315-33



**Dropout Voltage vs. Temperature**  
AP7315-25

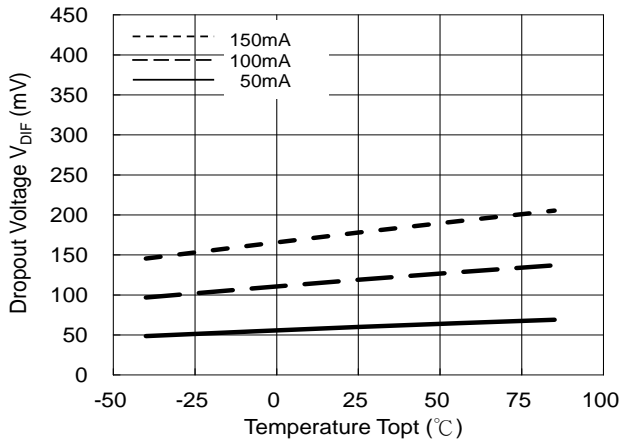

**Dropout Voltage vs. Temperature**  
AP7315-33



**Ripple Rejection vs. Frequency**  
AP7315-18

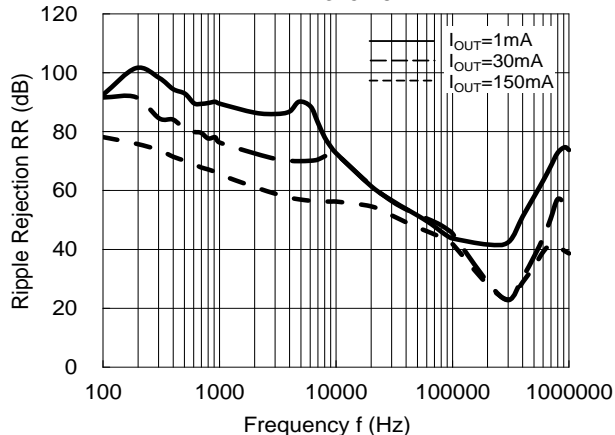

**Ripple Rejection vs. Frequency**  
AP7315-25



**Typical Characteristics (Cont.)**

NEW PRODUCT

**Ripple Rejection vs. Frequency**

AP7315-33



AP7315-25

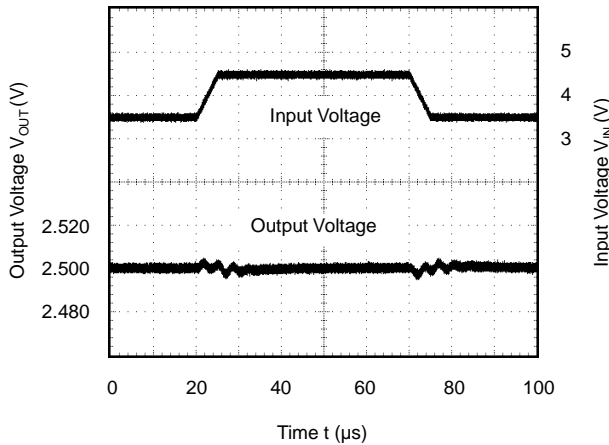

AP7315-33



AP7315-25  $V_{IN}=3.5V$   
 $tr=tf=0.5\mu s$



AP7315-33  $V_{IN}=4.3V$   
 $tr=tf=0.5\mu s$

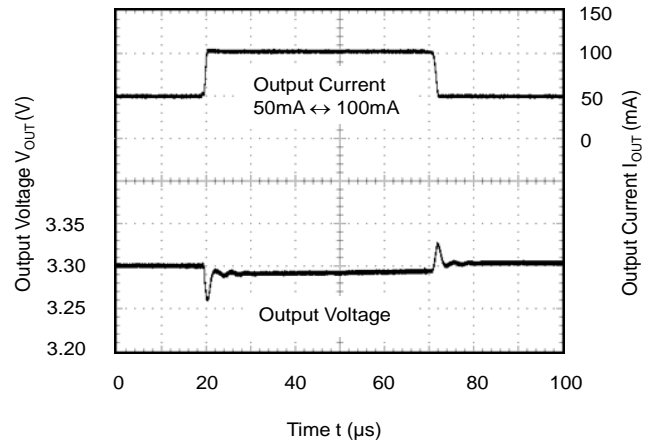



**Typical Characteristics (Cont.)**

NEW PRODUCT

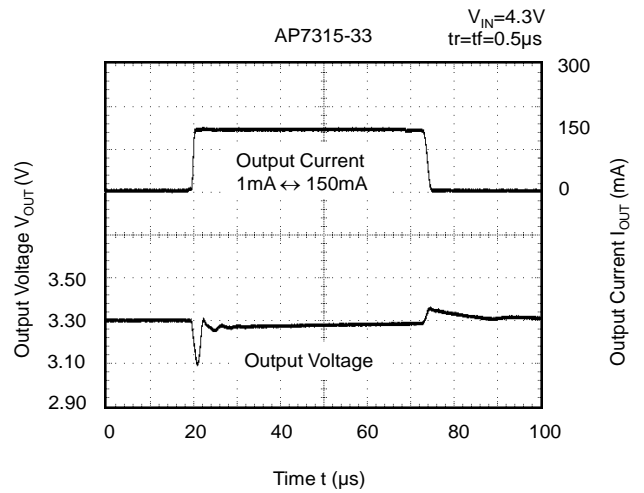

**Typical Characteristics (Cont.)**

NEW PRODUCT

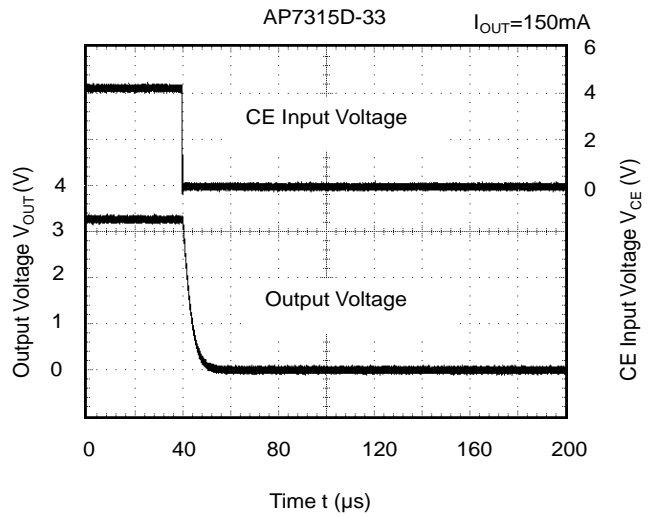
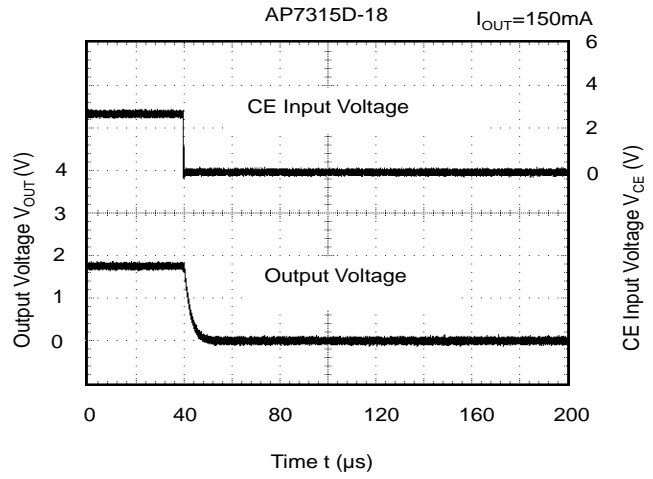
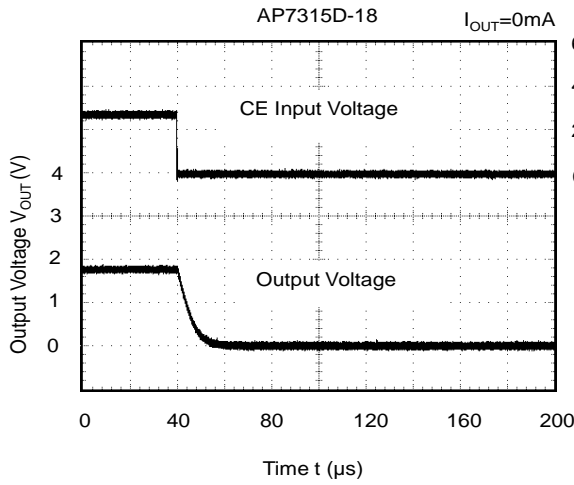

## Application Information

### Output Capacitor

An output capacitor ( $C_{OUT}$ ) is needed to improve transient response and maintain stability. The AP7315 is stable with very small ceramic output capacitors. The ESR (equivalent series resistance) and capacitance drives the selection. If the application has large load variations, it is recommended to utilize low-ESR bulk capacitors. It is recommended to place ceramic capacitors as close as possible to the load and the ground pin and care should be taken to reduce the impedance in the layout.

### Input Capacitor

To prevent the input voltage from dropping during load steps it is recommended to utilize an input capacitor ( $C_{IN}$ ). A minimum  $0.47\mu\text{F}$  ceramic capacitor is recommended between  $V_{IN}$  and GND pins to decouple input power supply glitch. This input capacitor must be located as close as possible to the device to assure input stability and reduce noise. For PCB layout, a wide copper trace is required for both  $V_{IN}$  and GND pins.

### Enable Control

The AP7315 is turned on by setting the EN pin high, and is turned off by pulling it low. If this feature is not used, the EN pin should be tied to  $V_{IN}$  pin to keep the regulator output on at all time. To ensure proper operation, the signal source used to drive the EN pin must be able to swing above and below the specified turn-on/off voltage thresholds listed in the Electrical Characteristics section.

### Short Circuit Protection

When  $V_{OUT}$  pin is short-circuit to GND, short circuit protection will be triggered and clamp the output current to approximately 60mA. This feature protects the regulator from over-current and damage due to overheating.

### Layout Considerations

For good ground loop and stability, the input and output capacitors should be located close to the  $V_{IN}$ ,  $V_{OUT}$ , and GND pins of the device. The regulator GND pin should be connected to the external circuit ground to reduce voltage drop caused by trace impedance. Ground plane is generally used to reduce trace impedance. Wide trace should be used for large current paths from  $V_{IN}$  to  $V_{OUT}$ , and load circuit.

## ESR vs. Output Current

Ceramic type output capacitor is recommended for this series; however, the other output capacitors with low ESR also can be used. The relations between  $I_{OUT}$  (Output Current) and ESR of an output capacitor are shown below. The stable region is marked as the hatched area in the graph.

Measurement conditions:

Frequency Band: 10Hz to 2MHz, Temperature:  $-40^{\circ}\text{C}$  to  $+85^{\circ}\text{C}$



**Ordering Information** (Note 12)

NEW PRODUCT



Part Number	Package Code	Packaging	7" Tape and Reel	
			Quantity	Part Number Suffix
AP7315-XXXFS4-7B	FS4	X2-DFN1010-4	10000/Tape & Reel	-7B
AP7315D-XXXFS4-7B	FS4	X2-DFN1010-4	10000/Tape & Reel	-7B
AP7315-XXXW5-7	W5	SOT25	3000/Tape & Reel	-7
AP7315D-XXXW5-7	W5	SOT25	3000/Tape & Reel	-7
AP7315-XXXSA-7	SA	SOT23	3000/Tape & Reel	-7
AP7315-XXXSR-7	SR	SOT23	3000/Tape & Reel	-7

Note: 12. For packaging details, go to our website at <http://www.diodes.com/products/packages.html>.

## Marking Information

(1) X2-DFN1010-4

(Top View)

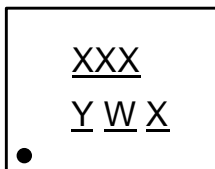

XXX : Identification Code

Y : Year : 0~9

W : Week : A~Z : 1~26 week;  
a~z : 27~52 week; z represents  
52 and 53 week

X : Internal Code

Part Number	Package	Identification Code
AP7315-11FS4-7B	X2-DFN1010-4	15A
AP7315-12FS4-7B	X2-DFN1010-4	15B
AP7315-135FS4-7B	X2-DFN1010-4	15C
AP7315-15FS4-7B	X2-DFN1010-4	15D
AP7315-18FS4-7B	X2-DFN1010-4	15E
AP7315-185FS4-7B	X2-DFN1010-4	15F
AP7315-22FS4-7B	X2-DFN1010-4	15G
AP7315-23FS4-7B	X2-DFN1010-4	15H
AP7315-25FS4-7B	X2-DFN1010-4	15J
AP7315-26FS4-7B	X2-DFN1010-4	15K
AP7315-28FS4-7B	X2-DFN1010-4	15M
AP7315-285FS4-7B	X2-DFN1010-4	15N
AP7315-295FS4-7B	X2-DFN1010-4	15P
AP7315-30FS4-7B	X2-DFN1010-4	15R
AP7315-31FS4-7B	X2-DFN1010-4	15S
AP7315-32FS4-7B	X2-DFN1010-4	15T
AP7315-33FS4-7B	X2-DFN1010-4	15U
AP7315D-11FS4-7B	X2-DFN1010-4	5DA
AP7315D-12FS4-7B	X2-DFN1010-4	5DB
AP7315D-135FS4-7B	X2-DFN1010-4	5DC
AP7315D-15FS4-7B	X2-DFN1010-4	5DD
AP7315D-18FS4-7B	X2-DFN1010-4	5DE
AP7315D-185FS4-7B	X2-DFN1010-4	5DF
AP7315D-22FS4-7B	X2-DFN1010-4	5DG
AP7315D-23FS4-7B	X2-DFN1010-4	5DH
AP7315D-25FS4-7B	X2-DFN1010-4	5DJ
AP7315D-26FS4-7B	X2-DFN1010-4	5DK
AP7315D-28FS4-7B	X2-DFN1010-4	5DM
AP7315D-285FS4-7B	X2-DFN1010-4	5DN
AP7315D-29FS4-7B	X2-DFN1010-4	5DP
AP7315D-295FS4-7B	X2-DFN1010-4	5DR
AP7315D-30FS4-7B	X2-DFN1010-4	5DS
AP7315D-31FS4-7B	X2-DFN1010-4	5DT
AP7315D-32FS4-7B	X2-DFN1010-4	5DU
AP7315D-33FS4-7B	X2-DFN1010-4	5DV

NEW PRODUCT

**Marking Information** (Cont.)

(2) SOT25

(Top View)



XXX : Identification Code

Y : Year 0 to 9

W : Week : A to Z : 1 to 26 week;  
a to z : 27 to 52 week; z represents  
52 and 53 week

X : Internal Code

Part Number	Package	Identification Code
AP7315-11W5-7	SOT25	15A
AP7315-12W5-7	SOT25	15B
AP7315-135W5-7	SOT25	15C
AP7315-15W5-7	SOT25	15D
AP7315-18W5-7	SOT25	15E
AP7315-185W5-7	SOT25	15F
AP7315-22W5-7	SOT25	15G
AP7315-23W5-7	SOT25	15H
AP7315-25W5-7	SOT25	15J
AP7315-26W5-7	SOT25	15K
AP7315-28W5-7	SOT25	15M
AP7315-285W5-7	SOT25	15N
AP7315-295W5-7	SOT25	15P
AP7315-30W5-7	SOT25	15R
AP7315-31W5-7	SOT25	15S
AP7315-32W5-7	SOT25	15T
AP7315-33W5-7	SOT25	15U
AP7315D-11W5-7	SOT25	5DA
AP7315D-12W5-7	SOT25	5DB
AP7315D-135W5-7	SOT25	5DC
AP7315D-15W5-7	SOT25	5DD
AP7315D-18W5-7	SOT25	5DE
AP7315D-185W5-7	SOT25	5DF
AP7315D-22W5-7	SOT25	5DG
AP7315D-23W5-7	SOT25	5DH
AP7315D-25W5-7	SOT25	5DJ
AP7315D-26W5-7	SOT25	5DK
AP7315D-28W5-7	SOT25	5DM
AP7315D-285W5-7	SOT25	5DN
AP7315D-29W5-7	SOT25	5DP
AP7315D-295W5-7	SOT25	5DR
AP7315D-30W5-7	SOT25	5DS
AP7315D-31W5-7	SOT25	5DT
AP7315D-32W5-7	SOT25	5DU
AP7315D-33W5-7	SOT25	5DV

NEW PRODUCT

**Marking Information** (Cont.)

(3) SOT23

(Top View)



XXX : Identification Code  
Y : Year 0 to 9  
W : Week : A to Z : 1 to 26 week;  
a to z : 27 to 52 week; z represents  
52 and 53 week  
X : Internal Code

NEW PRODUCT

Part Number	Package	Identification Code
AP7315-11SA-7	SOT23	15A
AP7315-12SA-7	SOT23	15B
AP7315-135SA-7	SOT23	15C
AP7315-15SA-7	SOT23	15D
AP7315-18SA-7	SOT23	15E
AP7315-185SA-7	SOT23	15F
AP7315-22SA-7	SOT23	15G
AP7315-23SA-7	SOT23	15H
AP7315-25SA-7	SOT23	15J
AP7315-26SA-7	SOT23	15K
AP7315-28SA-7	SOT23	15M
AP7315-285SA-7	SOT23	15N
AP7315-295SA-7	SOT23	15P
AP7315-30SA-7	SOT23	15R
AP7315-31SA-7	SOT23	15S
AP7315-32SA-7	SOT23	15T
AP7315-33SA-7	SOT23	15U
AP7315-11SR-7	SOT23	5DA
AP7315-12SR-7	SOT23	5DB
AP7315-135SR-7	SOT23	5DC
AP7315-15SR-7	SOT23	5DD
AP7315-18SR-7	SOT23	5DE
AP7315-185SR7	SOT23	5DF
AP7315-22SR-7	SOT23	5DG
AP7315-23SR-7	SOT23	5DH
AP7315-25SR-7	SOT23	5DJ
AP7315-26SR-7	SOT23	5DK
AP7315-28SR-7	SOT23	5DM
AP7315-285SR-7	SOT23	5DN
AP7315-295SR-7	SOT23	5DR
AP7315-30SR-7	SOT23	5DS
AP7315-31SR-7	SOT23	5DT
AP7315-32SR-7	SOT23	5DU
AP7315-33SR-7	SOT23	5DV

**Package Outline Dimensions**

Please see AP02002 at <http://www.diodes.com/datasheets/ap02002.pdf> for the latest version.

(1) Package Type: X2-DFN1010-4



X2-DFN1010-4			
Dim	Min	Max	Typ
A	-	0.40	0.39
A1	0.00	0.05	0.02
A3	-	-	0.13
b	0.20	0.30	0.25
D	0.95	1.05	1.00
D2	0.38	0.58	0.48
E	0.95	1.05	1.00
E2	0.38	0.58	0.48
e	-	-	0.65
L	0.20	0.30	0.25
L1	0.27	0.37	0.32
L2	0.02	0.12	0.07
Z	-	-	0.050
All Dimensions in mm			

NEW PRODUCT



**Package Outline Dimensions** (All dimensions in mm.)

(2) Package Type: SOT23



NEW PRODUCT

**Package Outline Dimensions** (All dimensions in mm.)

(3) Package Type: SOT25

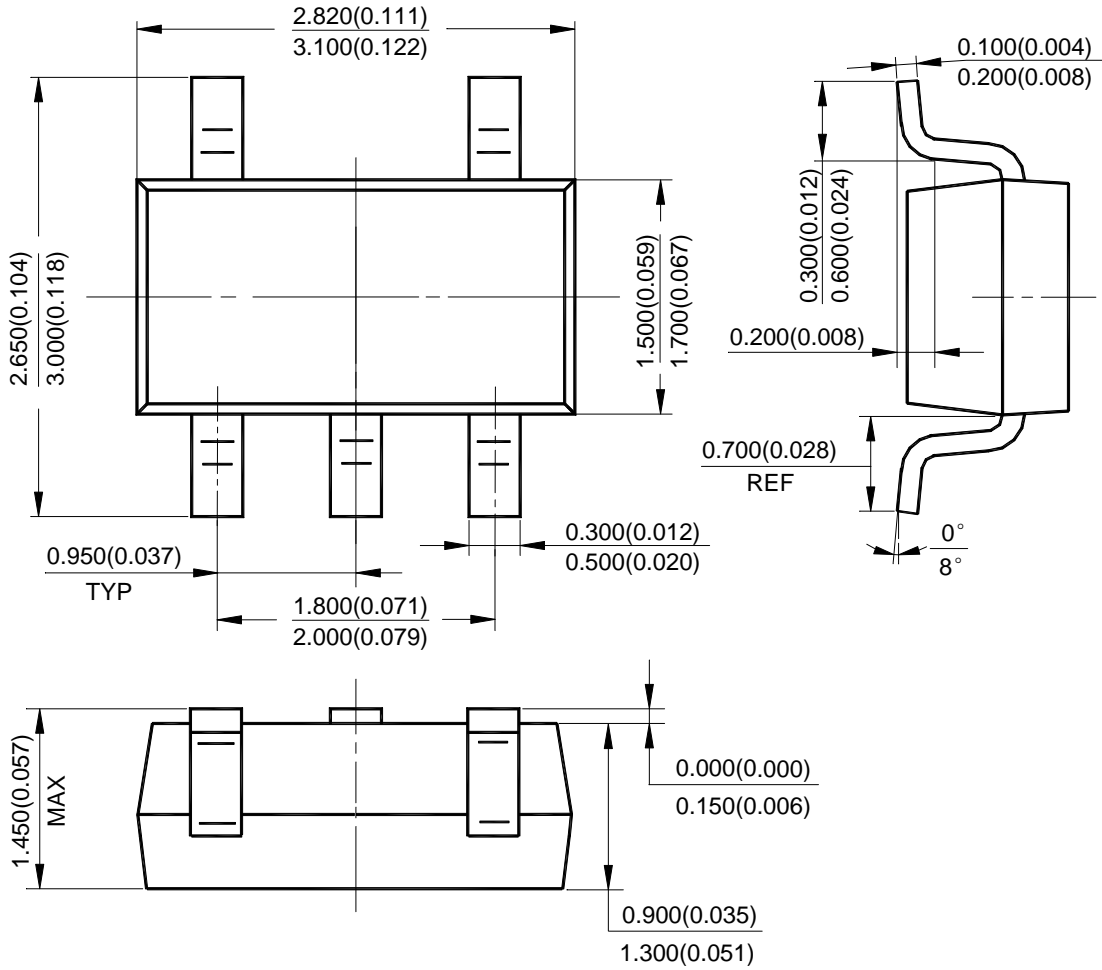

NEW PRODUCT

## Suggested Pad Layout

Please see AP02001 at <http://www.diodes.com/datasheets/ap02001.pdf> for the latest version.

(1) Package Type: X2-DFN1010-4



Dimensions	Value (in mm)
C	0.650
X	0.250
X1	0.480
X2	0.900
X3	0.070
Y	0.400
Y1	0.470
Y2	0.220
Y3	0.480
Y4	1.300
Y5	0.180

**Suggested Pad Layout** (Cont.)

(2) Package Type: SOT23



Dimensions	Z (mm)/(inch)	G (mm)/(inch)	X (mm)/(inch)	Y (mm)/(inch)	E (mm)/(inch)
Value	2.900/0.114	1.100/0.043	0.800/0.031	0.900/0.035	0.950/0.037

NEW PRODUCT

**Suggested Pad Layout (Cont.)**

(3) Package Type: SOT25



Dimensions	Z (mm)/(inch)	G (mm)/(inch)	X (mm)/(inch)	Y (mm)/(inch)	E1 (mm)/(inch)	E2 (mm)/(inch)
Value	3.600/0.142	1.600/0.063	0.700/0.028	1.000/0.039	0.950/0.037	1.900/0.075

NEW PRODUCT

**Tape Orientation**

For AP7315-XXXFS4-7B & AP7315D-XXXFS4-7B



Note: 13. The taping orientation of the other package type can be found on our website at <http://www.diodes.com/datasheets/ap02007.pdf>.

NEW PRODUCT