

Description

The AP7343 is a low dropout regulator with high output voltage accuracy, low $R_{DS(ON)}$, high PSRR, low output noise, and low quiescent current. This regulator is based on a CMOS process.

The AP7343 includes a voltage reference, error amplifier, current limit circuit, and an enable input to turn it on and off. With the integrated resistor network fixed output voltage versions can be delivered.

With its low power consumption and line and load transient response, the AP7343 is well suited for low-power handheld communication equipment.

The AP7343 is packaged in the X2-DFN1010-4 (Type B) and SOT25 packages, allowing for the smallest footprint and a dense PCB layout.

Pin Assignments



X2-DFN1010-4 (Type B)

PIN1 – V_{OUT} , PIN2 – GND, PIN3 – EN, PIN4 – V_{IN}



SOT25

Features

- Low V_{IN} and Wide V_{IN} Range: 1.7V to 5.25V
- Guarantee Output Current: 300mA
- V_{OUT} Accuracy $\pm 1\%$
- Ripple Rejection 75dB at 1kHz
- Low Output Noise, 60 μ Vrms from 10Hz to 100kHz
- Quiescent Current as Low as 35 μ A
- V_{OUT} Fixed 0.9V to 3.6V
- Moisture Sensitivity: Level 1 Per J-STD-020
- Terminals:
 - SOT25: Finish - Matte Tin Plated Leads, Solderable per MIL-STD-202, Method 208 ^(e3)
 - X2-DFN1010-4 (Type B): Finish - NiPdAu over Copper Leads, Solderable per MIL-STD-202, Method 208 ^(e4)
- Weight:
 - SOT25: 0.016 grams (Approximate)
 - X2-DFN1010-4 (Type B): 0.001 grams (Approximate)
- **Totally Lead-Free & Fully RoHS Compliant (Notes 1 & 2)**
- **Halogen- and Antimony-Free. "Green" Device (Note 3)**
- **For automotive applications requiring specific change control (i.e. parts qualified to AEC-Q100/101/200, PPAP capable, and manufactured in IATF 16949 certified facilities), please [contact us](mailto:contact@diodes.com) or your local Diodes representative. <https://www.diodes.com/quality/product-definitions/>**

Applications

- Smart Phone/Tablet
- RF Supply
- Cameras
- Portable Video
- Portable Media Player
- Wireless Adapter
- Wireless Communication

Notes: 1. No purposely added lead. Fully EU Directive 2002/95/EC (RoHS), 2011/65/EU (RoHS 2) & 2015/863/EU (RoHS 3) compliant.
 2. See <https://www.diodes.com/quality/lead-free/> for more information about Diodes Incorporated's definitions of Halogen- and Antimony-free, "Green" and Lead-free.
 3. Halogen- and Antimony-free "Green" products are defined as those which contain <900ppm bromine, <900ppm chlorine (<1500ppm total Br + Cl) and <1000ppm antimony compounds.

Typical Applications Circuit



Pin Descriptions

| Pin Number | | Pin Name | Function |
|-----------------------|-------|------------------|---|
| X2-DFN1010-4 (Type B) | SOT25 | | |
| 1 | 5 | V _{OUT} | Power Output Pin |
| 2 | 2 | GND | Ground |
| 3 | 3 | EN | Enable Pin This pin should be driven either high or low and must not be floating. Driving this pin high enables the regulator, while pulling it low puts the regulator into shutdown mode |
| 4 | 1 | V _{IN} | Power Input Pin |
| — | 4 | NC | No connection |
| EP | — | Exposed Pad | In PCB layout, prefer to use large copper area to cover this pad for better thermal dissipation, then connect this area to GND or leave it open. However, do not use it as GND electrode function alone |

Functional Block Diagram



AP7343D (With Discharge)



AP7343 (Without Discharge)

Absolute Maximum Ratings (Note 4) (@ $T_A = +25^\circ\text{C}$, unless otherwise specified.)

| Symbol | Parameter | Ratings | Unit |
|-----------|--------------------------------|------------------------|------------------|
| ESD HBM | Human Body Mode ESD Protection | > 2 | kV |
| ESD MM | Machine Mode ESD Protection | > 200 | V |
| V_{IN} | Input Voltage | 6.0 | V |
| V_{EN} | Input Voltage for EN Pin | 6.0 | V |
| V_{OUT} | Output Voltage | -0.3 to $V_{IN} + 0.3$ | V |
| I_{OUT} | Output Current | 400 | mA |
| P_D | Power Dissipation | 400 | mW |
| T_A | Operating Ambient Temperature | -40 to +85 | $^\circ\text{C}$ |
| T_J | Operating Junction Temperature | +125 | $^\circ\text{C}$ |
| T_{STG} | Storage Temperature | -55 to +125 | $^\circ\text{C}$ |

Notes: 4. Stresses beyond those listed under *Absolute Maximum Ratings* can cause permanent damage to the device. These are stress ratings only and functional operation of the device at these conditions is not implied. Exposure to absolute-maximum-rated conditions for extended period may affect device reliability. Ratings apply to ambient temperature at +25 $^\circ\text{C}$. The JEDEC High-K board design used to derive this data was a 2 inch \times 2 inch multilayer board with 1oz. internal power and ground planes and 2oz. copper traces on the top and bottom of the board.

Recommended Operating Conditions (@ $T_A = +25^\circ\text{C}$, unless otherwise specified.)

| Symbol | Parameter | Min | Max | Unit |
|-----------|-------------------------------|-----|------|------------------|
| V_{IN} | Input Voltage | 1.7 | 5.25 | V |
| I_{OUT} | Output Current | 0 | 300 | mA |
| T_A | Operating Ambient Temperature | -40 | +85 | $^\circ\text{C}$ |

Electrical Characteristics (@ $T_A = +25^\circ\text{C}$, $V_{IN} = V_{OUT} + 1.0\text{V}$, $C_{IN} = C_{OUT} = 1.0\mu\text{F}$, $I_{OUT} = 1.0\text{mA}$, unless otherwise specified.)

| Parameter | Condition | | Min | Typ | Max | Unit |
|--|--|--|-------------------------|--------------|-------------------------|-----------------------|
| Input Voltage | $T_A = -40^\circ\text{C}$ to $+85^\circ\text{C}$ | | 1.7 | — | 5.25 | V |
| Output Voltage Accuracy (Note 11) | $V_{OUT}(T) \geq 2.0\text{V}$, $V_{IN} = V_{OUT}(T) + 1\text{V}$ | $T_A = +25^\circ\text{C}$ | $V_{OUT}(T)^*$ 0.99 | $V_{OUT}(T)$ | $V_{OUT}(T)^*$ 1.01 | V |
| | $V_{OUT}(T) < 2.0\text{V}$, $V_{IN} = V_{OUT}(T) + 1\text{V}$ | $T_A = +25^\circ\text{C}$ | $V_{OUT}(T)^*$ -20mV | $V_{OUT}(T)$ | $V_{OUT}(T)^*$ +20mV | |
| Line Regulation ($dV_{OUT}/dV_{IN}/V_{OUT}$) | $V_{IN} = (V_{OUT-Nom} + 1.0\text{V})$ to 5.25V , $I_{OUT} = 1.0\text{mA}$ | | — | 0.02 | 0.1 | %/V |
| Load Regulation | $V_{IN} = V_{OUT-Nom} + 1.0\text{V}$, $I_{OUT} = 1\text{mA}$ to 300mA | | — | 15 | 30 | mV |
| Quiescent Current (Note 6) | $I_{OUT} = 0\text{mA}$ | | — | 35 | 60 | μA |
| $I_{STANDBY}$ | $V_{EN} = 0\text{V}$ (Disabled) | | — | 0.01 | 1.0 | μA |
| Output Current | — | | 300 | — | — | mA |
| Fold-back Short Current (Note 7) | V_{OUT} Short to Ground | | — | 55 | — | mA |
| PSRR (Note 8) | $V_{IN} = (V_{OUT} + 1\text{V}) V_{DC} + 0.2\text{Vp-pAC}$, $V_{OUT} \geq 1.8\text{V}$, $I_{OUT} = 30\text{mA}$ | $f = 1\text{kHz}$ | — | 75 | — | dB |
| Output Noise Voltage (Note 8) (Note 9) | BW = 10Hz to 100kHz, $I_{OUT} = 30\text{mA}$ | | — | 60 | — | μVrms |
| Dropout Voltage (Note 5) | $I_{OUT} = 300\text{mA}$ (X2-DFN1010-4 (Type B)) | $V_{OUT} = 0.9\text{V}$ | — | 0.51 | 0.80 | V |
| | | $1.0\text{V} < V_{OUT} \leq 1.2\text{V}$ | — | 0.46 | 0.70 | |
| | | $1.2\text{V} < V_{OUT} \leq 1.4\text{V}$ | — | 0.39 | 0.58 | |
| | | $1.4\text{V} < V_{OUT} \leq 1.7\text{V}$ | — | 0.35 | 0.44 | |
| | | $1.7\text{V} < V_{OUT} \leq 2.1\text{V}$ | — | 0.30 | 0.39 | |
| | | $2.1\text{V} < V_{OUT} \leq 2.5\text{V}$ | — | 0.26 | 0.34 | |
| | | $2.5\text{V} < V_{OUT} \leq 3.0\text{V}$ | — | 0.25 | 0.30 | |
| | | $3.0\text{V} < V_{OUT} \leq 3.6\text{V}$ | — | 0.22 | 0.29 | |
| | $I_{OUT} = 300\text{mA}$ (SOT25) | $V_{OUT} = 0.9\text{V}$ | — | 0.51 | 0.82 | V |
| | | $1.0\text{V} < V_{OUT} \leq 1.2\text{V}$ | — | 0.46 | 0.72 | |
| | | $1.2\text{V} < V_{OUT} \leq 1.4\text{V}$ | — | 0.39 | 0.60 | |
| | | $1.4\text{V} < V_{OUT} \leq 1.7\text{V}$ | — | 0.35 | 0.46 | |
| | | $1.7\text{V} < V_{OUT} \leq 2.1\text{V}$ | — | 0.30 | 0.41 | |
| | | $2.1\text{V} < V_{OUT} \leq 2.5\text{V}$ | — | 0.26 | 0.36 | |
| Output Voltage Temperature Coefficient | $I_{OUT} = 30\text{mA}$, $T_A = -40^\circ\text{C}$ to $+85^\circ\text{C}$ | | — | ± 30 | — | ppm/ $^\circ\text{C}$ |
| | Thermal Shutdown Threshold (TSHDN) | | — | +150 | — | $^\circ\text{C}$ |
| Thermal Shutdown Hysteresis (THYS) | | — | — | +20 | — | $^\circ\text{C}$ |
| EN Input Low Voltage | | — | 0 | — | 0.5 | V |
| EN Input High Voltage | | — | 1.3 | — | 5.25 | V |
| EN Input Leakage | | $V_{EN} = 0$, $V_{IN} = 5.0\text{V}$ or $V_{EN} = 5.0\text{V}$, $V_{IN} = 0\text{V}$ | -1.0 | — | +1.0 | μA |
| On Resistance of N-Channel for Auto-Discharge (Note 10) | | $V_{IN} = 4.0\text{V}$, $V_{EN} = 0\text{V}$ (Disabled) | — | 30 | — | Ω |
| Thermal Resistance Junction to Ambient (θ_{JA}) | X2-DFN1010-4 (Type B) | | — | 237 | — | $^\circ\text{C/W}$ |
| | SOT25 | | — | 179 | — | |
| Thermal Resistance Junction to Case (θ_{JC}) | X2-DFN1010-4 (Type B) | | — | 96 | — | |
| | SOT25 | | — | 52 | — | |

- Notes:
- Dropout voltage is the voltage difference between the input and the output at which the output voltage drops 2% below its nominal value.
 - Quiescent current is defined here as the difference in current between the input and the output.
 - Short circuit current is measured with V_{OUT} pulled to GND.
 - This specification is guaranteed by design.
 - To make sure lowest environment noise minimizes the influence on noise measurement.
 - AP7343 has 2 options for output, built-in discharge and non-discharge.
 - Potential multiple grades based on following output voltage accuracy.

Typical Characteristics

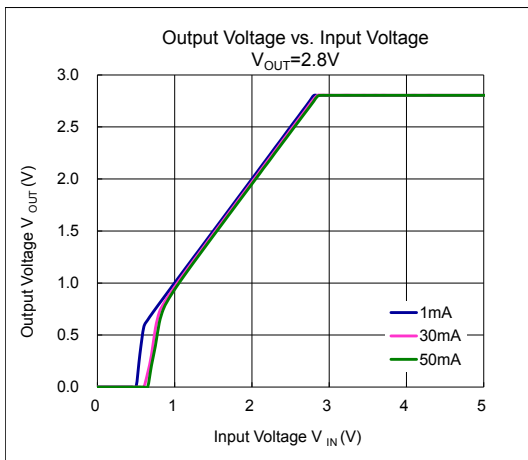
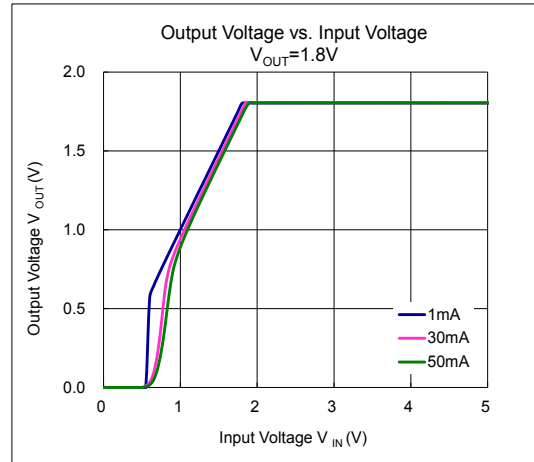
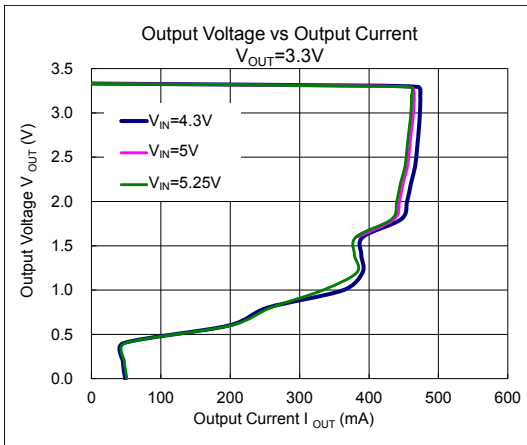

Typical Characteristics (continued)



Typical Characteristics (continued)



Typical Characteristics (continued)



Line Transient Response Waveforms ($I_{OUT} = 30mA$, $t_R = t_F = 5\mu s$, $C_{IN} = \text{None}$, $C_{OUT1} = C_{OUT2} = 1\mu F$, $T_A = +25^\circ C$)

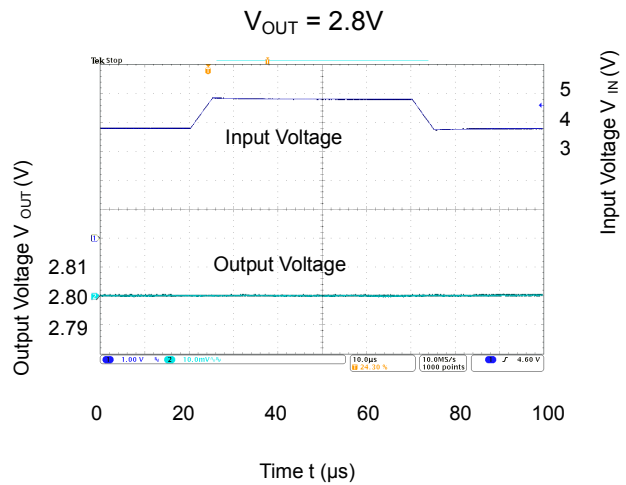

Typical Characteristics (continued)

Load Transient Response Waveforms ($V_{IN} = V_{OUT} + 1V$, $C_{IN} = 1\mu F$, $T_A = +25^\circ C$)



Typical Characteristics (continued)

Load Transient Response Waveforms ($V_{IN} = V_{OUT} + 1V$, $C_{IN} = 1\mu F$, $T_A = +25^\circ C$)



Typical Characteristics (continued)

Turn On & Off Waveforms ($V_{IN} = V_{OUT} + 1V$, $C_{IN} = 1\mu F$, $C_{OUT} = 1\mu F$, $T_A = +25^\circ C$)



Application Information

Output Capacitor

An output capacitor (C_{OUT}) is needed to improve transient response and maintain stability. The AP7343 is stable with very small ceramic output capacitors. The ESR (equivalent series resistance) and capacitance drive the selection. If the application has large load variations, it is recommended to utilize low-ESR bulk capacitors. It is recommended to place ceramic capacitors as close as possible to the load and the ground pin, and care should be taken to reduce the impedance in the layout.

Input Capacitor

To prevent the input voltage from dropping during load steps, it is recommended to utilize an input capacitor (C_{IN}). A minimum 0.47 μ F ceramic capacitor is recommended between V_{IN} and GND pins to decouple input power supply glitch. This input capacitor must be located as close as possible to the device to assure input stability and reduce noise. For PCB layout, a wide copper trace is required for both V_{IN} and GND pins.

Enable Control

The AP7343 is turned on by setting the EN pin high, and is turned off by pulling it low. If this feature is not used, the EN pin should be tied to the V_{IN} pin to keep the regulator output on at all times. To ensure proper operation, the signal source used to drive the EN pin must be able to swing above and below the specified turn-on/off voltage thresholds listed in the Electrical Characteristics section.

Short Circuit Protection

When V_{OUT} pin is short-circuit to GND, short circuit protection will be triggered and clamp the output current to approximately 60mA. This feature protects the regulator from overcurrent and damage due to overheating.

Layout Considerations

For good ground loop and stability, the input and output capacitors should be located close to the input, output, and ground pins of the device. The regulator ground pin should be connected to the external circuit ground to reduce voltage drop caused by trace impedance. Ground plane is generally used to reduce trace impedance. Wide trace should be used for large current paths from V_{IN} to V_{OUT} , and load circuit.

ESR vs. Output Current

A ceramic-type output capacitor is recommended for this series; however, other output capacitors with low ESR may be used. The relationship between the I_{OUT} (Output Current) and the ESR of an output capacitor are shown below. The stable region is marked as the hatched area in the graph.

Measurement conditions: Frequency Band: 10Hz to 2MHz, Temperature: -40°C to +85°C.

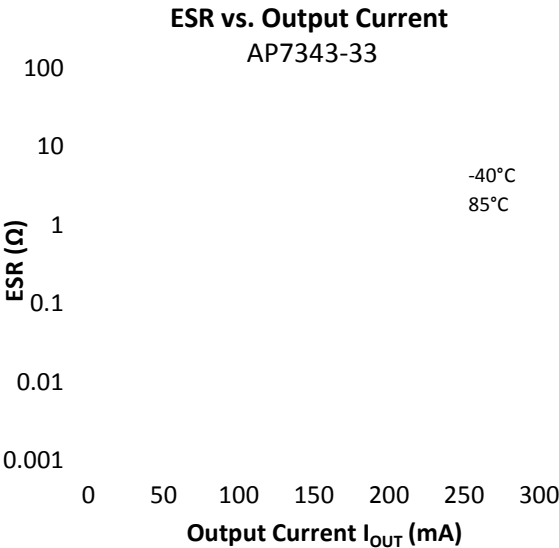

Ordering Information (Note 12)

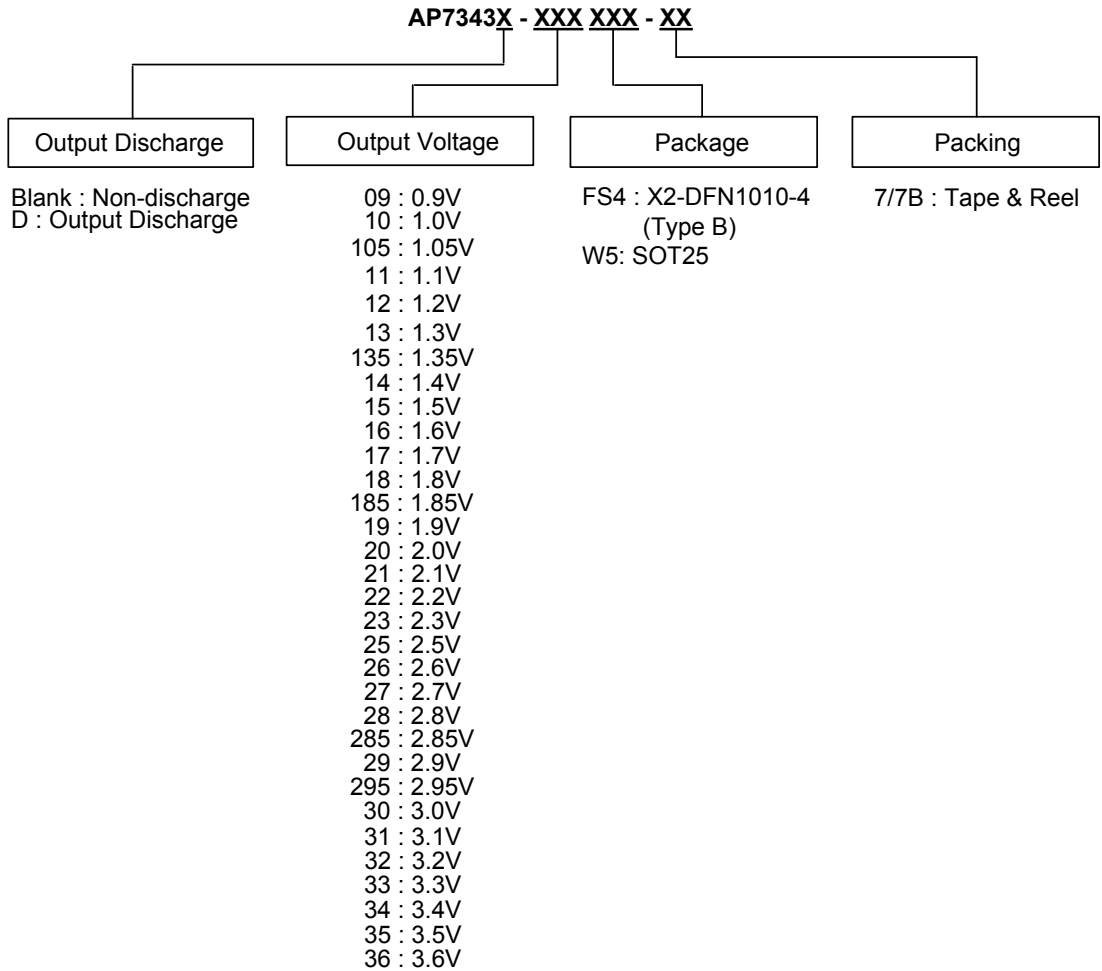

| Part Number | Package Code | Packaging | 7" Tape and Reel | |
|-------------------|--------------|-----------------------|--------------------|--------------------|
| | | | Quantity | Part Number Suffix |
| AP7343-XXXFS4-7B | FS4 | X2-DFN1010-4 (Type B) | 10,000/Tape & Reel | -7B |
| AP7343D-XXXFS4-7B | FS4 | X2-DFN1010-4 (Type B) | 10,000/Tape & Reel | -7B |
| AP7343D-XXXFS4-7 | FS4 | X2-DFN1010-4 (Type B) | 5,000/Tape & Reel | -7 |
| AP7343-XXXW5-7 | W5 | SOT25 | 3,000/Tape & Reel | -7 |
| AP7343D-XXXW5-7 | W5 | SOT25 | 3,000/Tape & Reel | -7 |

Note: 12. For packaging details, go to our website at <https://www.diodes.com/design/support/packaging/diodes-packaging/>.

Marking Information

(1) X2-DFN1010-4 (Type B)

(Top View)



XX : Identification Code
Y : Year : 0~9
W : Week : A~Z : 1~26 week;
 a~z : 27~52 week; z represents
 52 and 53 week
X : A~Z : Internal code

| Part Number | Package | Identification Code |
|-------------------|-----------------------|---------------------|
| AP7343-09FS4-7B | X2-DFN1010-4 (Type B) | 7B |
| AP7343-10FS4-7B | X2-DFN1010-4 (Type B) | 7C |
| AP7343-105FS4-7B | X2-DFN1010-4 (Type B) | 7D |
| AP7343-11FS4-7B | X2-DFN1010-4 (Type B) | 7E |
| AP7343-12FS4-7B | X2-DFN1010-4 (Type B) | 7F |
| AP7343-135FS4-7B | X2-DFN1010-4 (Type B) | 7G |
| AP7343-15FS4-7B | X2-DFN1010-4 (Type B) | 7H |
| AP7343-18FS4-7B | X2-DFN1010-4 (Type B) | 7J |
| AP7343-185FS4-7B | X2-DFN1010-4 (Type B) | 7K |
| AP7343-22FS4-7B | X2-DFN1010-4 (Type B) | 7M |
| AP7343-25FS4-7B | X2-DFN1010-4 (Type B) | 7N |
| AP7343-28FS4-7B | X2-DFN1010-4 (Type B) | 7P |
| AP7343-285FS4-7B | X2-DFN1010-4 (Type B) | 7R |
| AP7343-295FS4-7B | X2-DFN1010-4 (Type B) | 7S |
| AP7343-30FS4-7B | X2-DFN1010-4 (Type B) | 7T |
| AP7343-31FS4-7B | X2-DFN1010-4 (Type B) | 7U |
| AP7343-32FS4-7B | X2-DFN1010-4 (Type B) | 7V |
| AP7343-33FS4-7B | X2-DFN1010-4 (Type B) | 7W |
| AP7343D-09FS4-7B | X2-DFN1010-4 (Type B) | 8B |
| AP7343D-10FS4-7B | X2-DFN1010-4 (Type B) | 8C |
| AP7343D-105FS4-7B | X2-DFN1010-4 (Type B) | 8D |
| AP7343D-11FS4-7B | X2-DFN1010-4 (Type B) | 8E |
| AP7343D-12FS4-7B | X2-DFN1010-4 (Type B) | 8F |
| AP7343D-13FS4-7B | X2-DFN1010-4 (Type B) | 8G |
| AP7343D-135FS4-7B | X2-DFN1010-4 (Type B) | 8H |
| AP7343D-14FS4-7B | X2-DFN1010-4 (Type B) | 8J |
| AP7343D-15FS4-7B | X2-DFN1010-4 (Type B) | 8K |
| AP7343D-16FS4-7B | X2-DFN1010-4 (Type B) | 8M |
| AP7343D-17FS4-7B | X2-DFN1010-4 (Type B) | 8N |
| AP7343D-18FS4-7B | X2-DFN1010-4 (Type B) | 8P |
| AP7343D-185FS4-7B | X2-DFN1010-4 (Type B) | 8R |
| AP7343D-19FS4-7B | X2-DFN1010-4 (Type B) | 8S |
| AP7343D-20FS4-7B | X2-DFN1010-4 (Type B) | 8T |
| AP7343D-21FS4-7B | X2-DFN1010-4 (Type B) | 8U |
| AP7343D-22FS4-7B | X2-DFN1010-4 (Type B) | 8V |
| AP7343D-23FS4-7B | X2-DFN1010-4 (Type B) | 8W |
| AP7343D-25FS4-7B | X2-DFN1010-4 (Type B) | 8X |
| AP7343D-26FS4-7B | X2-DFN1010-4 (Type B) | 8Y |
| AP7343D-27FS4-7B | X2-DFN1010-4 (Type B) | 8Z |
| AP7343D-28FS4-7B | X2-DFN1010-4 (Type B) | 6J |
| AP7343D-285FS4-7B | X2-DFN1010-4 (Type B) | 6K |
| AP7343D-29FS4-7B | X2-DFN1010-4 (Type B) | 6M |
| AP7343D-295FS4-7B | X2-DFN1010-4 (Type B) | 6N |
| AP7343D-30FS4-7B | X2-DFN1010-4 (Type B) | 6P |
| AP7343D-31FS4-7B | X2-DFN1010-4 (Type B) | 6R |
| AP7343D-32FS4-7B | X2-DFN1010-4 (Type B) | 6S |
| AP7343D-33FS4-7B | X2-DFN1010-4 (Type B) | 6T |
| AP7343D-34FS4-7B | X2-DFN1010-4 (Type B) | 6U |
| AP7343D-35FS4-7B | X2-DFN1010-4 (Type B) | 6V |
| AP7343D-36FS4-7B | X2-DFN1010-4 (Type B) | 6W |
| AP7343D-12FS4-7 | X2-DFN1010-4 (Type B) | 8F |
| AP7343D-18FS4-7 | X2-DFN1010-4 (Type B) | 8P |
| AP7343D-28FS4-7 | X2-DFN1010-4 (Type B) | 6J |

Marking Information (continued)

(2) SOT25

(Top View)



XX : Identification Code
Y : Year 0 to 9
W : Week : A to Z : 1 to 26 week;
a to z : 27 to 52 week; z represents
52 and 53 week
X : Internal Code

| Part Number | Package Type | Identification Code |
|-----------------|--------------|---------------------|
| AP7343-09W5-7 | SOT25 | 7B |
| AP7343-10W5-7 | SOT25 | 7C |
| AP7343-105W5-7 | SOT25 | 7D |
| AP7343-11W5-7 | SOT25 | 7E |
| AP7343-12W5-7 | SOT25 | 7F |
| AP7343-135W5-7 | SOT25 | 7G |
| AP7343-15W5-7 | SOT25 | 7H |
| AP7343-18W5-7 | SOT25 | 7J |
| AP7343-185W5-7 | SOT25 | 7K |
| AP7343-22W5-7 | SOT25 | 7M |
| AP7343-25W5-7 | SOT25 | 7N |
| AP7343-28W5-7 | SOT25 | 7P |
| AP7343-285W5-7 | SOT25 | 7R |
| AP7343-295W5-7 | SOT25 | 7S |
| AP7343-30W5-7 | SOT25 | 7T |
| AP7343-31W5-7 | SOT25 | 7U |
| AP7343-32W5-7 | SOT25 | 7V |
| AP7343-33W5-7 | SOT25 | 7W |
| AP7343D-09W5-7 | SOT25 | 8B |
| AP7343D-10W5-7 | SOT25 | 8C |
| AP7343D-105W5-7 | SOT25 | 8D |
| AP7343D-11W5-7 | SOT25 | 8E |
| AP7343D-12W5-7 | SOT25 | 8F |
| AP7343D-13W5-7 | SOT25 | 8G |
| AP7343D-135W5-7 | SOT25 | 8H |
| AP7343D-14W5-7 | SOT25 | 8J |
| AP7343D-15W5-7 | SOT25 | 8K |
| AP7343D-16W5-7 | SOT25 | 8M |
| AP7343D-17W5-7 | SOT25 | 8N |
| AP7343D-18W5-7 | SOT25 | 8P |
| AP7343D-185W5-7 | SOT25 | 8R |
| AP7343D-19W5-7 | SOT25 | 8S |
| AP7343D-20W5-7 | SOT25 | 8T |
| AP7343D-21W5-7 | SOT25 | 8U |
| AP7343D-22W5-7 | SOT25 | 8V |
| AP7343D-23W5-7 | SOT25 | 8W |
| AP7343D-25W5-7 | SOT25 | 8X |
| AP7343D-26W5-7 | SOT25 | 8Y |
| AP7343D-27W5-7 | SOT25 | 8Z |
| AP7343D-28W5-7 | SOT25 | 6J |
| AP7343D-285W5-7 | SOT25 | 6K |
| AP7343D-29W5-7 | SOT25 | 6M |
| AP7343D-295W5-7 | SOT25 | 6N |
| AP7343D-30W5-7 | SOT25 | 6P |
| AP7343D-31W5-7 | SOT25 | 6R |
| AP7343D-32W5-7 | SOT25 | 6S |
| AP7343D-33W5-7 | SOT25 | 6T |
| AP7343D-34W5-7 | SOT25 | 6U |
| AP7343D-35W5-7 | SOT25 | 6V |
| AP7343D-36W5-7 | SOT25 | 6W |

Package Outline Dimensions

Please see <http://www.diodes.com/package-outlines.html> for the latest version.

(1) X2-DFN1010-4 (Type B)



| X2-DFN1010-4 (Type B) | | | |
|-----------------------|------|------|-------|
| Dim | Min | Max | Typ |
| A | - | 0.40 | 0.39 |
| A1 | 0.00 | 0.05 | 0.02 |
| A3 | - | - | 0.13 |
| b | 0.20 | 0.30 | 0.25 |
| D | 0.95 | 1.05 | 1.00 |
| D2 | 0.43 | 0.53 | 0.48 |
| E | 0.95 | 1.05 | 1.00 |
| E2 | 0.43 | 0.53 | 0.48 |
| e | - | - | 0.65 |
| k | 0.19 | 0.29 | 0.24 |
| L | 0.20 | 0.30 | 0.25 |
| L1 | 0.02 | 0.12 | 0.07 |
| R | 0.02 | 0.08 | 0.05 |
| z | - | - | 0.050 |
| All Dimensions in mm | | | |

(2) SOT25

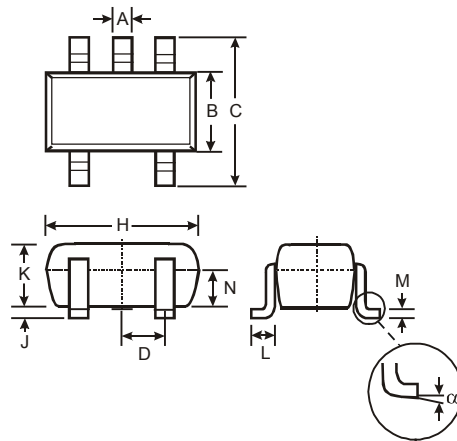

| SOT25 | | | |
|----------------------|-------|------|------|
| Dim | Min | Max | Typ |
| A | 0.35 | 0.50 | 0.38 |
| B | 1.50 | 1.70 | 1.60 |
| C | 2.70 | 3.00 | 2.80 |
| D | - | - | 0.95 |
| H | 2.90 | 3.10 | 3.00 |
| J | 0.013 | 0.10 | 0.05 |
| K | 1.00 | 1.30 | 1.10 |
| L | 0.35 | 0.55 | 0.40 |
| M | 0.10 | 0.20 | 0.15 |
| N | 0.70 | 0.80 | 0.75 |
| α | 0° | 8° | - |
| All Dimensions in mm | | | |

Suggested Pad Layout

Please see <http://www.diodes.com/package-outlines.html> for the latest version.

(1) X2-DFN1010-4 (Type B)

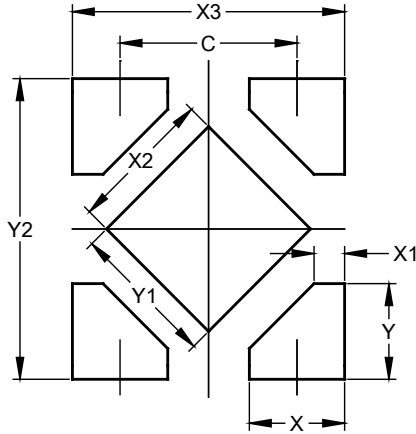

| Dimensions | Value (in mm) |
|------------|---------------|
| C | 0.650 |
| X | 0.350 |
| X1 | 0.112 |
| X2 | 0.530 |
| X3 | 1.00 |
| Y | 0.350 |
| Y1 | 0.530 |
| Y2 | 1.100 |

(2) SOT25

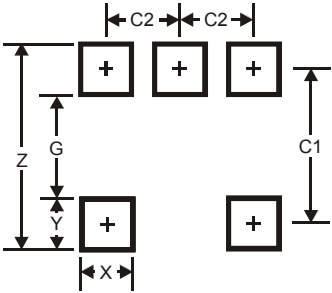

| Dimensions | Value |
|------------|-------|
| Z | 3.20 |
| G | 1.60 |
| X | 0.55 |
| Y | 0.80 |
| C1 | 2.40 |
| C2 | 0.95 |

Tape Orientation (Note 13)

For AP7343-XXXFS4-7B & AP7343D-XXXFS4-7B

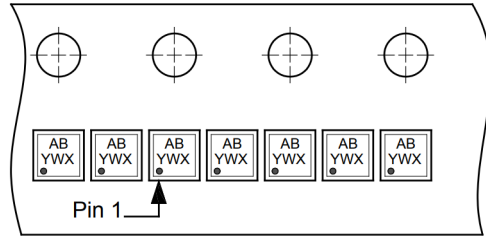
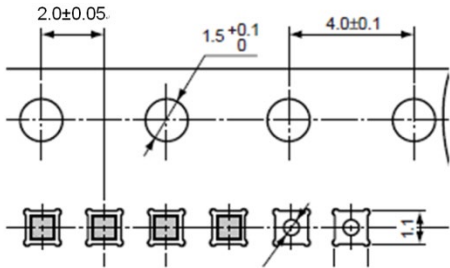

For AP7343D-XXXFS4-7

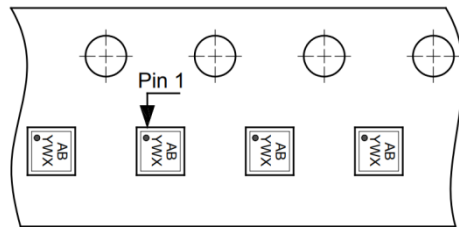
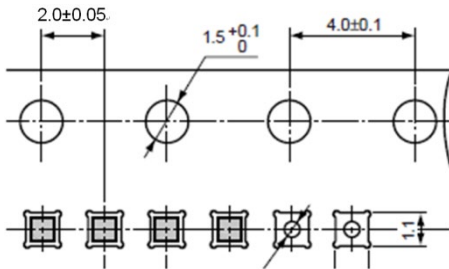

For AP7343-XXXW5-7 & AP7343D-XXXW5-7

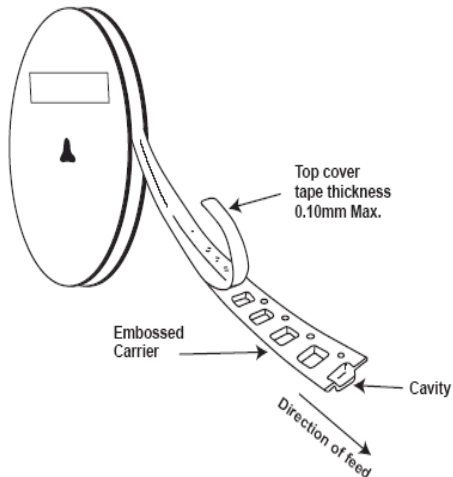
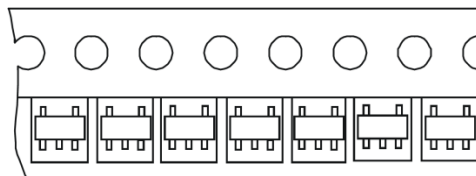
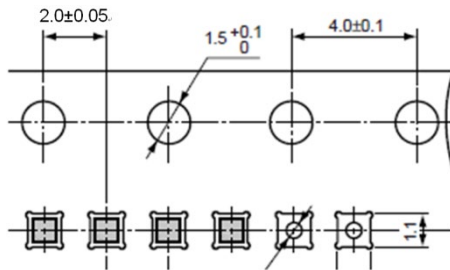

Note: 13. The taping orientation of other package types can be found on our website at <http://www.diodes.com/package-outlines.html>.