

Description

The AP9214L is a single chip protection solution specially designed for 1-cell Li+ rechargeable battery pack application.

The AP9214L includes a 1-cell Lion battery protection chip and dual N-CH, ultra low $R_{SS(ON)}$ MOSFET with common drain.

The AP9214L provides rich battery protection features and can turn-off the N-CH MOSFET by detecting overcharge voltage/current, over discharge voltage/current, or load short circuit. The AP9214L has built-in fixed delay time to save external components.

The AP9214L is available in U-DFN2535-6 package with two kinds of pin options.

Features

- High Voltage CMOS Process, up to 30V (V_{DD} to V_M)
- Low Quiescent Current (+25°C)
 - In Normal Mode, 3.0 μ A (Typ.), 4.5 μ A (Max.), $V_{DD} = 3.5V$
 - In Power-Down Mode, 0.1 μ A (Max.)
- High-Accuracy Voltage Detection Circuit (+25°C)
 - Overcharge Detection Voltage: 3.5V to 4.5V (5mV Steps) Accuracy $\pm 25mV$
 - Overcharge Hysteresis Voltage Range: 0.1V to 0.4V (50mV Steps) Accuracy $\pm 50mV$
 - Overdischarge Detection Voltage: 2.0V to 3.4V (10mV Steps) Accuracy $\pm 35mV$
 - Overdischarge Hysteresis Voltage Range: 0V to 0.7V (40mV Steps) Accuracy $\pm 65mV$
 - Discharge Overcurrent Detection Voltage: 0.05V to 0.32V (10mV Steps) Accuracy $\pm 15mV$
 - Short Current Detection Voltage: 0.45V to 0.7V (50mV Steps) Accuracy $\pm 100mV$
 - Charge Overcurrent Detection Voltage: -0.2V to -0.05V (10mV Steps) Accuracy $\pm 15mV$
 - Overcharger Detection Voltage: 8.0V (Fixed) Accuracy $\pm 2V$
 - Overcharger Release Voltage: 7.3V (Fixed) Accuracy $\pm 2V$
- Built-in Fixed Detection Delay Time (+25°C), Accuracy $\pm 20\%$
- Power-Down Mode Selectable (Yes or No)
- 0V Battery Charge Selectable (Permission or Inhibition)
- Overcharge Protection Mode Selectable (Auto Release or Latch)
- **Totally Lead-Free & Fully RoHS Compliant (Notes 1 & 2)**
- **Halogen and Antimony Free. "Green" Device (Note 3)**

Notes: 1. No purposely added lead. Fully EU Directive 2002/95/EC (RoHS), 2011/65/EU (RoHS 2) & 2015/863/EU (RoHS 3) compliant.
 2. See <https://www.diodes.com/quality/lead-free/> for more information about Diodes Incorporated's definitions of Halogen- and Antimony-free, "Green" and Lead-free.
 3. Halogen- and Antimony-free "Green" products are defined as those which contain <900ppm bromine, <900ppm chlorine (<1500ppm total Br + Cl) and <1000ppm antimony compounds.

Pin Assignments



U-DFN2535-6 (Option 1)



U-DFN2535-6 (Option 2)

Applications

- Li+ Rechargeable Battery Pack

Typical Applications Circuit (Note 4)

A (B)
 A for Pin-out Option 1
 B for Pin-out Option 2

Note: 4. R1 and C1 are used to stabilize the supply voltage of the AP9214L. The recommended range of R1 value is 330Ω to 470Ω and C1 value is 10nF to 1000nF, typical value is 100nF. R2 should be connected between P- to VM sense terminal to monitor the status of charger and the charge/discharge current. The R2 should be between 300Ω and 4kΩ, typical value is 2.7kΩ. R1 and R2 are also used as current limit resistors if the battery or charger is connected reversely. Polarity reversing may cause the power consumption of R1 and R2 to go over their power dissipation rating, therefore R1 and R2 values should be selected appropriately for the actual application. If R2 is more than 4kΩ resistor, charge may not be off due to the voltage drop on R2.

For power-down mode, when first connecting AP9214L system board to the battery, it is necessary to use charger or to short P- to the battery negative polarity. Once the AP9214L is activated, the charger or connection can be removed, otherwise the battery cannot discharge current through system board.

The values selected should follow the recommended typical range mentioned above. It has not been confirmed whether the operation is normal or not in circuits other than the above example of connection. In addition, the example of connection shown above and the typical value do not exactly guarantee proper operation. Please perform the actual application to set the suitable value through your complete evaluation.

Pin Descriptions

Pin Number Option 1	Pin Number Option 2	Pin Name	Function
1	1	S1	Source pin of discharging MOSFET, connecting this pin to battery negative pole.
2	2	VSS	Negative power supply pin.
3	3	VDD	Positive power supply pin, connecting this pin to battery positive pole through R1.
4	5	VM	Charger negative input pin, short this pin to S2 pin through R2.
5	4	NC	Not connected, leave this pin floating.
6	6	S2	Source pin of charging MOSFET, connecting this pin to charge negative input.
EP	EP	Drain	Thermal PAD is common drain of charge and discharge MOSFET, so in PCB layout, prefer to use large copper area to cover this pad for better thermal dissipation, then leave it open.

Functional Block Diagram

NEW PRODUCT

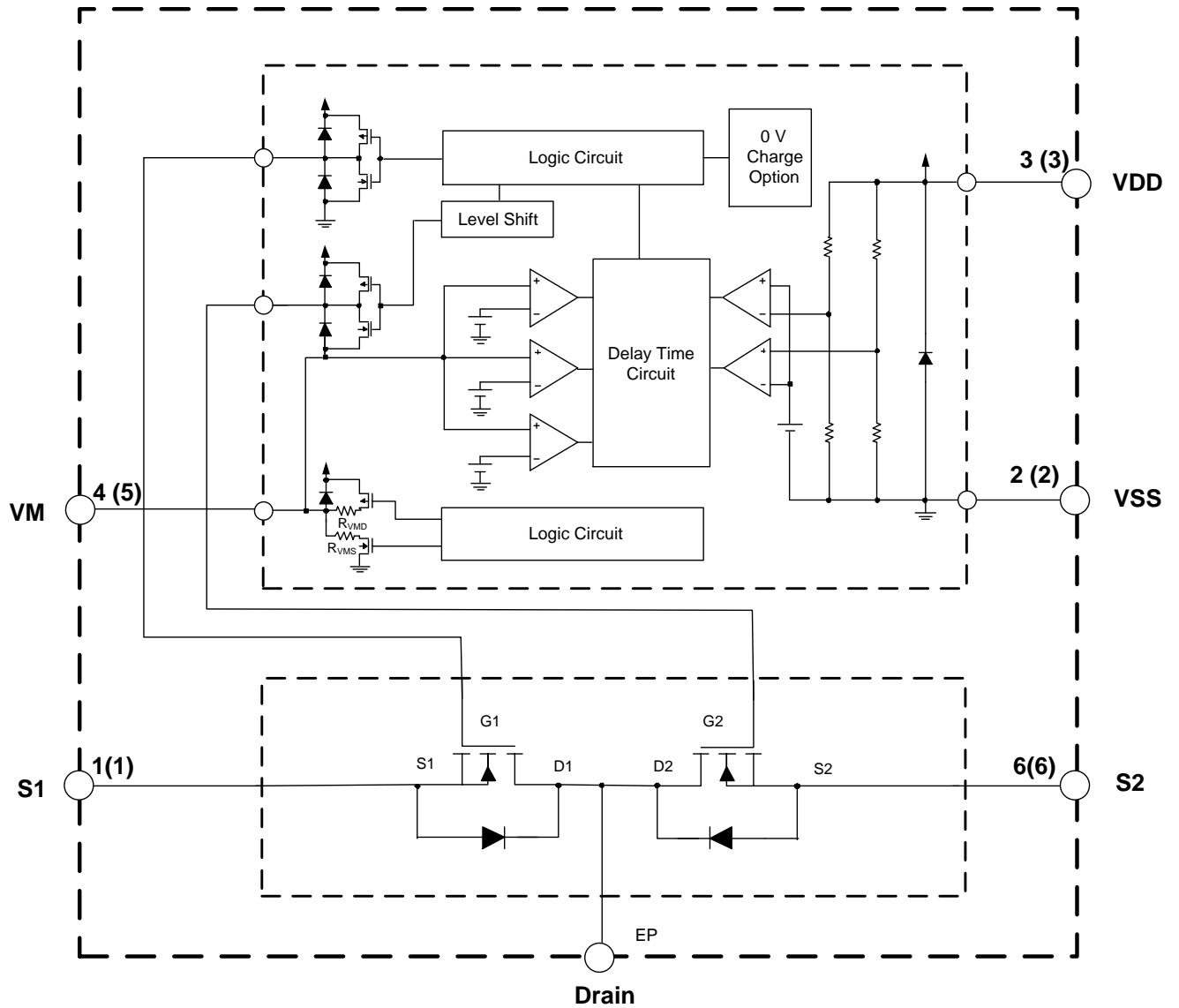

A (B)
A for Pin-out Option 1
B for Pin-out Option 2

Absolute Maximum Ratings (Notes 5 & 6)

Symbol	Parameter	Ratings	Unit
V_{DS}	Supply Voltage (Between V_{DD} and V_{SS})	-0.3 to 12	V
V_{DM}	Charge Input Voltage (Between V_{DD} and V_M for Protection Chip)	-0.3 to 24	V
V_{DSS}	MOSFET Drain-to-Source Voltage	24	V
V_{GSS}	MOSFET Gate-to-Source Voltage	± 12	V
I_D	Continuous Drain Current, $V_{GS} = 4.5V$, $T_A = +25^\circ C$	9.0	A
	Continuous Drain Current, $V_{GS} = 4.5V$, $T_A = +70^\circ C$	7.1	A
P_D	Power Dissipation	1000	mW
T_J	Maximum Junction Temperature	+150	$^\circ C$
T_{STG}	Storage Temperature Range	-65 to +150	$^\circ C$

- Notes:
- Stresses beyond those listed under Absolute Maximum Ratings may cause permanent damage to the device. These are stress ratings only and functional operation of the device at these conditions is not implied. Exposure to absolute-maximum-rated conditions for extended periods may affect device reliability.
 - Ratings apply to ambient temperature at +25 $^\circ C$. The JEDEC High-K board design used to derive this data was a 2 inch x 2 inch multilayer board with 2-ounce internal power and ground planes and 2-ounce copper traces on the top and bottom of the board.

Recommended Operating Conditions

Symbol	Parameter	Min	Max	Unit
V_{DS}	Supply Voltage (Between V_{DD} and V_{SS})	1.5	5.5	V
V_{DM}	Charge Input Voltage (Between V_{DD} and V_M)	-0.3	5.5	V
T_A	Operating Ambient Temperature	-40	+85	$^\circ C$

Electrical Characteristics ($T_A = +25^\circ\text{C}$, $V_{DD} = 3.5\text{V}$, $V_{SS} = 0\text{V}$, $R_1 = 220\Omega$, $R_2 = 1.0\text{k}\Omega$, $C_1 = 100\text{nF}$, unless otherwise specified.)

Symbol	Parameter	Conditions	Min	Typ	Max	Units	
V_{CU}	Overcharge Detection Voltage	—	V_{CU} - 0.025	V_{CU}	V_{CU} + 0.025	V	
V_{CL}	Overcharge Release Voltage	$V_{CL} \neq V_{CU}$	V_{CL} - 0.050	V_{CL}	V_{CL} + 0.050	V	
		$V_{CL} = V_{CU}$	V_{CL} - 0.025	V_{CL}	V_{CL} + 0.025	V	
V_{DL}	Overdischarge Detection Voltage	—	V_{DL} - 0.035	V_{DL}	V_{DL} + 0.035	V	
V_{DU}	Overdischarge Release Voltage	$V_{DU} \neq V_{DL}$	V_{DU} - 0.100	V_{DU}	V_{DU} + 0.100	V	
		$V_{DU} = V_{DL}$	V_{DU} - 0.035	V_{DU}	V_{DU} + 0.035	V	
V_{DOC}	Discharge Overcurrent Detection Voltage	—	V_{DOC} -0.015	V_{DOC}	V_{DOC} +0.015	V	
V_{SHORT}	Load Short-Circuiting Detection Voltage	—	V_{SHORT} -0.10	V_{SHORT}	V_{SHORT} +0.10	V	
V_{COC}	Charge Overcurrent Detection Voltage	—	V_{COC} -0.015	V_{COC}	V_{COC} +0.015	V	
I_{CC}	Current Consumption During Operation	$V_{DD} = 3.5\text{V}$, $V_M = 0\text{V}$	1.5	3.0	4.5	μA	
I_{STB}	Current Consumption at Power Down	$V_{DD} = 1.8\text{V}$ VM Pin Floating	Power Down Mode	—	—	0.1	μA
			Without Power Down Mode (Auto Wake up)	—	—	5.5	μA
R_{VMD}	Resistance Between VM Pin and VDD Pin	$V_{DD} = 1.8\text{V}$, $V_M = 0\text{V}$	150	300	500	$\text{k}\Omega$	
R_{VMS}	Resistance Between VM Pin and VSS Pin	$V_{DD} = 3.5\text{V}$, $V_M = 1.0\text{V}$	10	30	50	$\text{k}\Omega$	
V_{0CHA}	0V Battery Charge Starting Charge Voltage	0V Battery Charging "Available"	1.2	—	—	V	
V_{0INH}	0V Battery Charge Inhibition Battery Voltage	0V Battery Charging "Unavailable"	—	—	0.45	V	
V_{OVCHG}	Overvoltage Charge Detection Voltage	$V_{DD} = 3.5\text{V}$	6.0	8.0	10.0	V	
V_{OVCHGR}	Overvoltage Charge Release Voltage	$V_{DD} = 3.5\text{V}$	5.3	7.3	9.3	V	
t_{CU}	Overcharge Detection Delay Time	—	$t_{CU} * 0.8$	t_{CU}	$t_{CU} * 1.2$	ms	
t_{CUR}	Overcharge Release Delay Time	—	$t_{CUR} * 0.8$	t_{CUR}	$t_{CUR} * 1.2$	ms	
t_{DL}	Overdischarge Detection Delay Time	—	$t_{DL} * 0.8$	t_{DL}	$t_{DL} * 1.2$	ms	
t_{DLR}	Overdischarge Release Delay Time	—	$t_{DLR} * 0.8$	t_{DLR}	$t_{DLR} * 1.2$	ms	
t_{DOC}	Discharge Overcurrent Detection Delay Time	—	$t_{DOC} * 0.8$	t_{DOC}	$t_{DOC} * 1.2$	ms	
t_{DOCR}	Discharge Overcurrent Release Delay Time	—	$t_{DOCR} * 0.8$	t_{DOCR}	$t_{DOCR} * 1.2$	ms	
t_{SHORT}	Load Short Detection Delay Time	—	$t_{SHORT} * 0.8$	t_{SHORT}	$t_{SHORT} * 1.2$	μs	
t_{COC}	Charge Overcurrent Detection Delay Time	—	$t_{COC} * 0.8$	t_{COC}	$t_{COC} * 1.2$	ms	
t_{COCR}	Charge Overcurrent Release Delay Time	—	$t_{COCR} * 0.8$	t_{COCR}	$t_{COCR} * 1.2$	ms	

Electrical Characteristics (Cont.)

 (T_A = -40°C to +85°C, V_{DD} = 3.5V, V_{SS} = 0V, R₁ = 220Ω, R₂ = 1.0kΩ, C₁ = 100nF, unless otherwise specified.)

Symbol	Parameter	Conditions	Min	Typ	Max	Units	
V _{CU}	Overcharge Detection Voltage	—	V _{CU} - 0.060	V _{CU}	V _{CU} + 0.040	V	
V _{CL}	Overcharge Release Voltage	V _{CL} ≠ V _{CU}	V _{CL} - 0.080	V _{CL}	V _{CL} + 0.065	V	
		V _{CL} = V _{CU}	V _{CL} - 0.060	V _{CL}	V _{CL} + 0.040	V	
V _{DL}	Overdischarge Detection Voltage	—	V _{DL} - 0.080	V _{DL}	V _{DL} + 0.080	V	
V _{DU}	Overdischarge Release Voltage	V _{DU} ≠ V _{DL}	V _{DU} - 0.150	V _{DU}	V _{DU} + 0.190	V	
		V _{DU} = V _{DL}	V _{DU} - 0.080	V _{DU}	V _{DU} + 0.080	V	
V _{DOC}	Discharge Overcurrent Detection Voltage	—	V _{DOC} -0.021	V _{DOC}	V _{DOC} +0.024	V	
V _{SHORT}	Load Short Detection Voltage	—	V _{SHORT} -0.34	V _{SHORT}	V _{SHORT} +0.34	V	
V _{COC}	Charge Overcurrent Detection Voltage	—	V _{COC} -0.040	V _{COC}	V _{COC} +0.040	V	
I _{CC}	Current Consumption During Operation	V _{DD} = 3.5V, V _M = 0V	1.0	3.0	7.0	μA	
I _{STB}	Current Consumption at Power Down	V _{DD} = 1.8V VM Pin Floating	Power Down Mode	—	—	1.0	μA
			Without Power Down Mode (Auto Wake up)	—	—	8	μA
R _{VMD}	Resistance Between VM Pin and VDD Pin	V _{DD} = 1.8V, V _M = 0V	100	300	650	kΩ	
R _{VMS}	Resistance Between VM Pin and VSS Pin	V _{DD} = 3.5V, V _M = 1.0V	5	30	65	kΩ	
V _{0CHA}	0V Battery Charge Starting Charge Voltage	0V Battery Charging “Available”	1.2	—	—	V	
V _{0INH}	0V Battery Charge Inhibition Battery Voltage	0V Battery Charging “Unavailable”	—	—	0.3	V	
V _{OVCHG}	Overvoltage Charge Detection Voltage	V _{DD} = 3.5V	5.5	8.0	10.5	V	
V _{OVCHGR}	Overvoltage Charge Release Voltage	V _{DD} = 3.5V	5.0	7.3	9.5	V	
t _{CU}	Overcharge Detection Delay Time	—	t _{CU} * 0.6	t _{CU}	t _{CU} * 1.4	ms	
t _{CUR}	Overcharge Release Delay Time	—	t _{CUR} * 0.6	t _{CUR}	t _{CUR} * 1.4	ms	
t _{DL}	Overdischarge Detection Delay Time	—	t _{DL} * 0.6	t _{DL}	t _{DL} * 1.4	ms	
t _{DLR}	Overdischarge Release Delay Time	—	t _{DLR} * 0.6	t _{DLR}	t _{DLR} * 1.4	ms	
t _{DOC}	Discharge Overcurrent Detection Delay Time	—	t _{DOC} * 0.6	t _{DOC}	t _{DOC} * 1.4	ms	
t _{DOCR}	Discharge Overcurrent Release Delay Time	—	t _{DOCR} * 0.6	t _{DOCR}	t _{DOCR} * 1.4	ms	
t _{SHORT}	Load Short Detection Delay Time	—	t _{SHORT} * 0.6	t _{SHORT}	t _{SHORT} * 1.4	μs	
t _{COC}	Charge Overcurrent Detection Delay Time	—	t _{COC} * 0.6	t _{COC}	t _{COC} * 1.4	ms	
t _{COCR}	Charge Overcurrent Release Delay Time	—	t _{COCR} * 0.6	t _{COCR}	t _{COCR} * 1.4	ms	

Electrical Characteristics (Cont., Notes 7, 8)

($T_A = +25^\circ\text{C}$, $V_{DD} = 3.5\text{V}$, $V_{SS} = 0\text{V}$, $R1 = 220\Omega$, $R2 = 1.0\text{k}\Omega$, $C1 = 100\text{nF}$, unless otherwise specified.)

Symbol	Parameter	Conditions	Min	Typ	Max	Units
I_{DSS}	Zero Gate Voltage Drain Current	$V_{DS} = 20\text{V}$, $V_{GS} = 0$	—	—	1.0	μA
$R_{SS(ON)1}$	Static Source-Source On-Resistance 1	$V_{DD} = 4.0\text{V}$, $I_D = 1.0\text{A}$	10	13	16	$\text{m}\Omega$
$R_{SS(ON)2}$	Static Source-Source On-Resistance 2	$V_{DD} = 3.9\text{V}$, $I_D = 1.0\text{A}$	10	13.5	16.5	$\text{m}\Omega$
$R_{SS(ON)3}$	Static Source-Source On-Resistance 3	$V_{DD} = 3.0\text{V}$, $I_D = 1.0\text{A}$	11	14	17	$\text{m}\Omega$
V_{SD}	Diode Forward Voltage	$V_{GS} = 0\text{V}$, $I_S = 1\text{A}$	—	0.75	1.0	V

Notes: 7. In case of Gate-Source voltage of charging MOSFET is 0V. In case of Gate-Source voltage of discharging MOSFET is 0V.
 8. These specifications are guaranteed by design - will not be tested in production.

Application Information

Operation Mode

1. Normal Status

The AP9214L monitors the battery voltage between the VDD pin and VSS pin as well as the voltage difference between the VM pin and VSS pin to control battery charging and discharging. When the battery voltage is between overdischarge detection voltage (V_{DL}) and overcharge detection voltage (V_{CU}) as well as the VM pin voltage is between the charge overcurrent detection voltage (V_{COC}) and discharge overcurrent detection voltage (V_{DOC}), the AP9214L will turn on discharging and charging MOSFET. In these conditions, the battery can charge and discharge freely. Also, R_{VMD} does not connect to VDD pin and R_{VMS} does not connect to VSS pin in this status.

2. Overcharge Status

If the battery voltage is more than V_{CU} during charging status for the overcharge detection delay time (t_{CU}) or longer, the AP9214L turns off the charging MOSFET to stop charging. R_{VMD} and R_{VMS} are not connected in overcharge status.

When VM pin voltage is lower than V_{DOC} and battery voltage falls below V_{CL} , the AP9214L will release from overcharge status.

When VM pin voltage is equal or more than V_{DOC} and battery voltage falls below V_{CU} , the AP9214L will release from overcharge status.

3. Overdischarge Status

If the battery voltage is less than V_{DL} during discharging status for the overdischarge detection delay time (t_{DL}) or longer, the AP9214L turns off the discharging MOSFET to stop discharging. In overdischarge status, R_{VMD} is connected to VDD and VM pin voltage is pulled up to VDD by R_{VMD} , but R_{VMS} is not connected.

For power-down mode version, the AP9214L recovers normal status from overdischarge status only by charging the battery through the charger.

When VM pin voltage to VSS pin voltage is less than typical -0.7V and the battery voltage rises over V_{DL} , the AP9214L will release from overdischarge status. If VM pin voltage to VSS pin voltage is higher than typical -0.7V, the AP9214L will release from overdischarge status until the battery voltage rises over V_{DU} .

For auto-wake-up version AP9214LA, the device recovers to normal status from overdischarge status if either of these two conditions are satisfied:

If charger is connected: the AP9214LA overdischarge status is released in the same way as described above in AP9214L overdischarge Status section.

If no charger is connected:

- 1) The battery voltage reaches the overdischarge release voltage (V_{DU}) or higher;
- 2) Maintains continuous time more than overdischarge release delay time t_{DLR} .

4. Discharge Overcurrent and Short Current Status

When battery is in discharge overcurrent status, if the voltage of the VM pin to VSS pin is equal or more than V_{DOC} to V_{SHORT} and detection lasts for the discharge overcurrent detection delay time (t_{DOC}) or longer, the AP9214L turns off the discharging MOSFET to stop discharging.

When the battery is in short current status, if the voltage of the VM pin to VSS pin is equal to or more than V_{SHORT} , and the detection lasts for the short current detection delay time or longer, the AP9214L turns off the discharge MOSFET to stop discharging.

In discharge overcurrent or short current status, R_{VMS} is connected to VSS but R_{VMD} is not connected. The voltage of VM pin is almost equal to V_{DD} as long as the load is connected. When the load is disconnected, the voltage of VM pin will become almost equal to VSS (due to R_{VMS} being connected) and then the AP9214L will release from discharge overcurrent or short current status.

5. Charge Overcurrent Status

When the battery is in charge overcurrent status, if the voltage of the VM pin to VSS pin is equal to or less than V_{COC} and the detection continues for the charge overcurrent detection delay time (t_{COC}) or longer, the AP9214L turns off the charging MOSFET to stop charging.

6. 0V Battery Charging Function (Optional)

This function is available as an option and can be factory set internally. The AP9214L has this function built in.

0V charging function permits charger to recharge the battery whose voltage is 0V due to self-discharge. If 0V charging function is not present, the device will prevent charger to recharge the battery whose voltage is 0V due to self-discharge. (If a device without 0V charging function is needed, please contact Diodes sales team.)

Application Information (Cont.)

7. Overvoltage Charger Detection Circuit

This function is used to monitor the charger voltage between the VDD pin and VM pin, and when this voltage exceeds overvoltage charger detection voltage (8.0V Typ.), the AP9214L will turn off charging MOSFET, when this voltage drops below overvoltage charger release voltage (7.3V Typ.), it then turns on charging MOSFET. There is no delay time setting for detection and release.

8. Power-Down Mode or Auto-Wake-Up Function (Optional)

In device with power-down function, during power-down mode, device enters the overdischarge status. The IC enters sleep mode and the current consumption becomes very low, typically 0.1 μ A. To release from power-down status to the normal status, charger connection is required.

In device with auto-wakeup mode, the IC remains active in the overdischarge state. The IC is released into the normal state by the operation that increases the battery voltage more than overdischarge release voltage.

Application Information (Timing Chart)

1. Overcharge and Overdischarge Detection

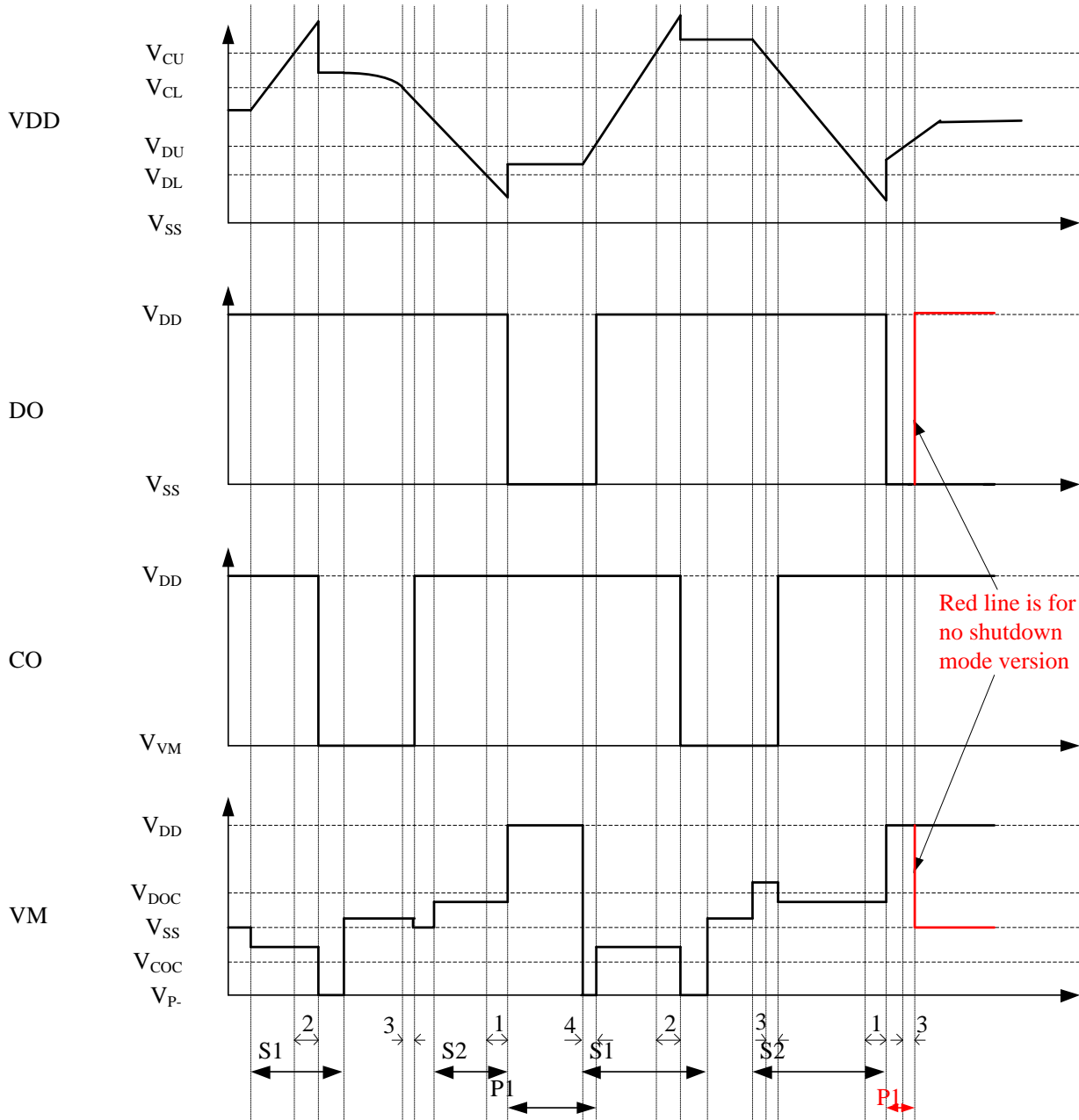

- 1: t_{DL}
- 2: t_{CU}
- 3: t_{CUR}
- 4: t_{DLR}

- S1: Charger connection
- S2: Load connection
- P1: R_{VMD} pull-up connection

NEW PRODUCT

Application Information (Timing Chart) (Cont.)

2. Discharge Overcurrent Detection

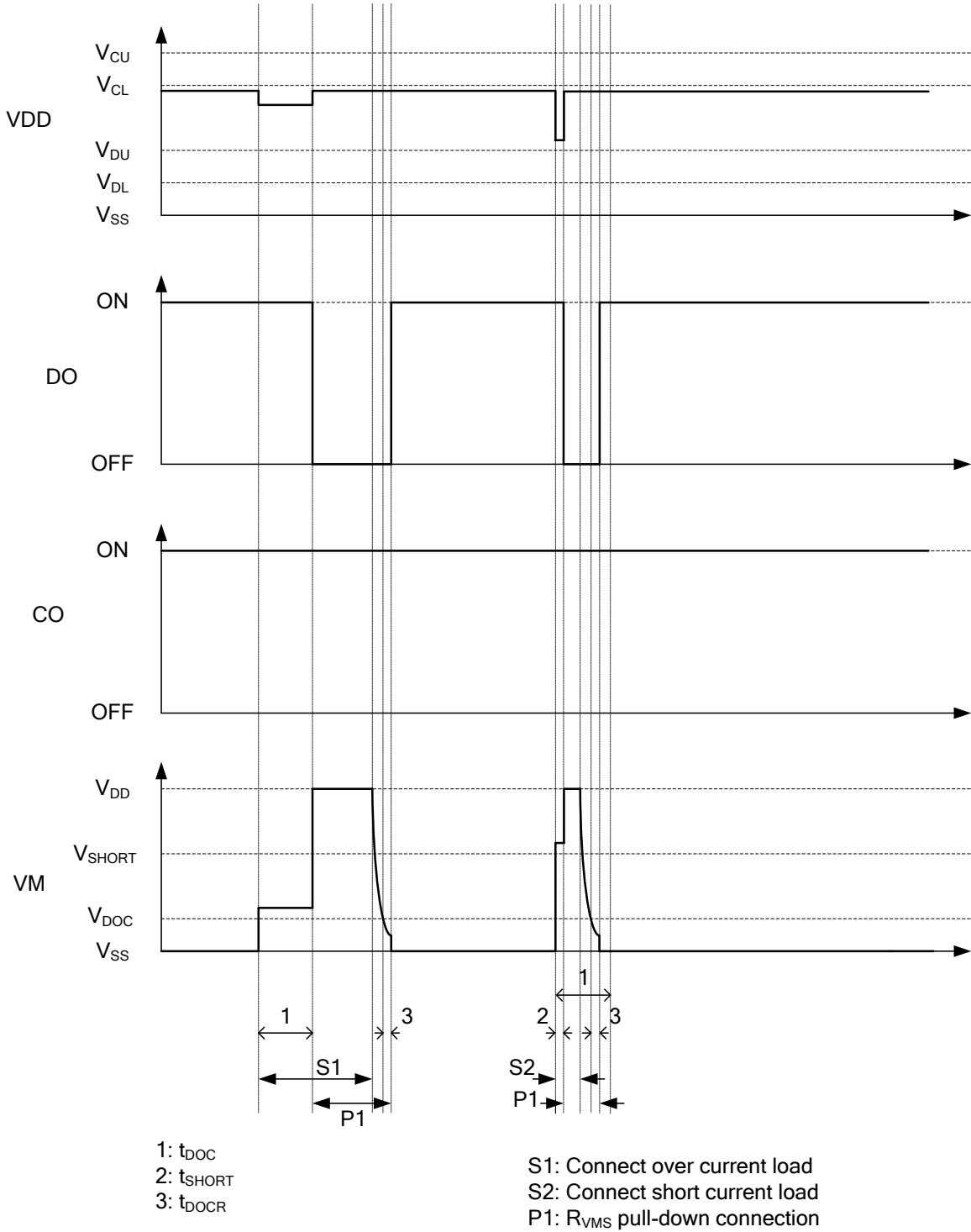

NEW PRODUCT

Application Information (Timing Chart) (Cont.)

NEW PRODUCT

3. Charge Overcurrent Detection

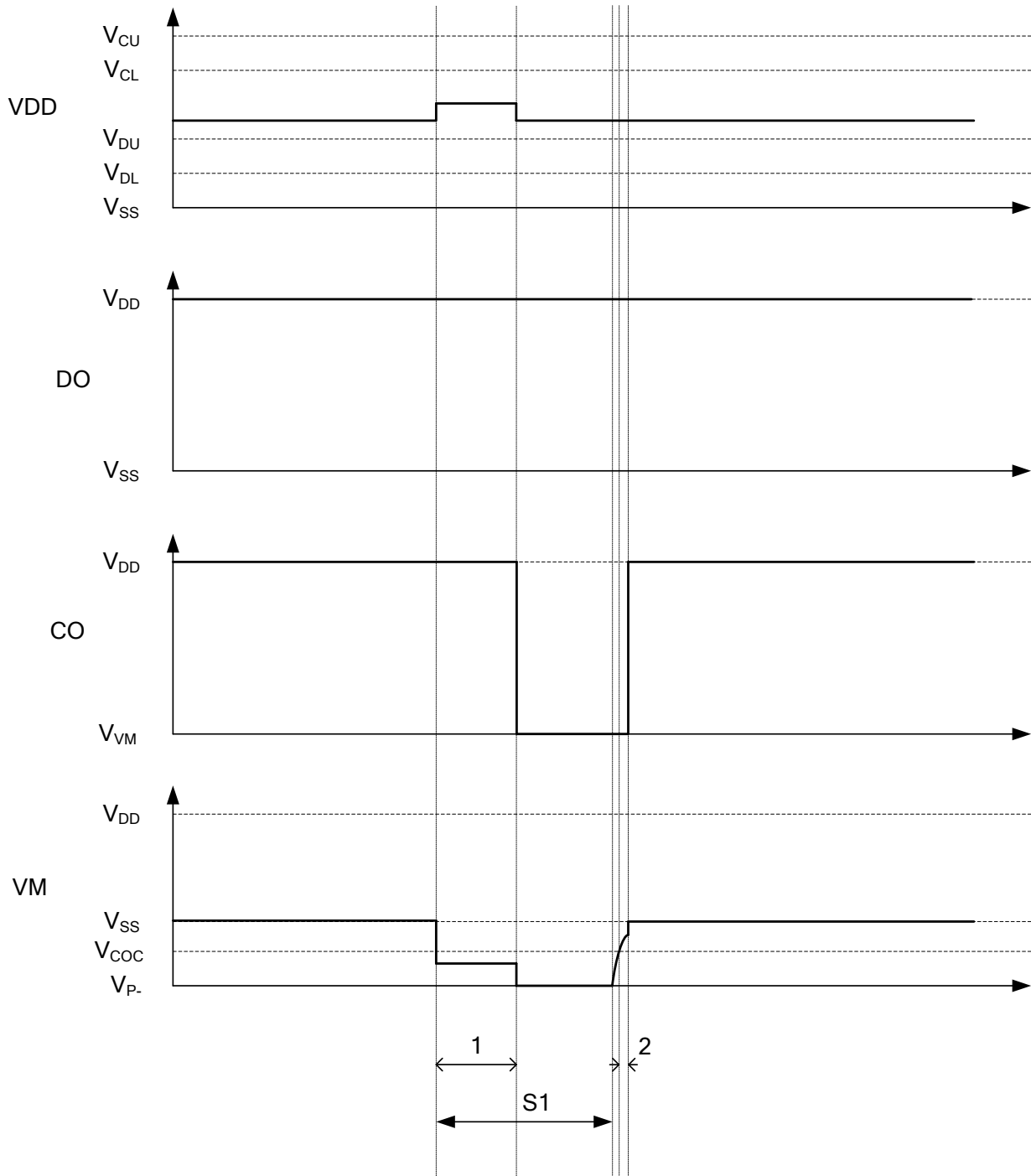

1: t_{COC}
2: t_{COCR}

S1: Connect over current charger

Ordering Information (Note 9)



Device	Package Code	Packaging	Pin Out	7" Tape and Reel	
				Quantity	Part Number Suffix
AP9214L(X)-X-HSB-7	HSB	U-DFN2535-6	Option 1	3000/Tape & Reel	-7
AP9214L(X)-X-HSBR-7	HSBR	U-DFN2535-6	Option 2	3000/Tape & Reel	-7

Voltage Combination

Part Number	Overcharge Detection Voltage V _{CU}	Overcharge Release Voltage V _{CL}	Overdischarge Detection Voltage V _{DL}	Overdischarge Release Voltage V _{DU}	Discharge Overcurrent Detection Voltage V _{DOC}	Load Short Detection Voltage V _{SHORT}	Charge Overcurrent Detection Voltage V _{COC}	Over Voltage Charger Detection Voltage V _{OVCHG}	Over Voltage Charger Release Voltage V _{OVCHGR}	Powr-down Function	Overcharge Protection Mode	Delay Time	0V Battery Charge Function
AP9214L(X)-AA-HSB(X)-7	4.375V	4.175V	2.500V	2.900V	0.150V	0.700V	-0.150V	8.0V	7.3V	Selectable	Auto Release	Option 1	Permission
AP9214L(X)-AB-HSB(X)-7	4.425V	4.225V	2.500V	2.900V	0.150V	0.700V	-0.150V	8.0V	7.3V	Selectable	Auto Release	Option 1	Permission
AP9214L(X)-AC-HSB(X)-7	4.375V	4.175V	2.500V	2.900V	0.095V	0.700V	-0.095V	8.0V	7.3V	Selectable	Auto Release	Option 1	Permission
AP9214L(X)-AD-HSB(X)-7	4.375V	4.175V	2.500V	2.900V	0.120V	0.700V	-0.120V	8.0V	7.3V	Selectable	Auto Release	Option 1	Permission
AP9214L(X)-AE-HSB(X)-7	4.200V	4.100V	2.500V	3.000V	0.300V	0.550V	-0.100V	8.0V	7.3V	Selectable	Auto Release	Option 1	Permission
AP9214L(X)-AF-HSB(X)-7	4.375V	4.175V	2.500V	2.900V	0.180V	0.700V	-0.180V	8.0V	7.3V	Selectable	Auto Release	Option 1	Permission
AP9214L(X)-AG-HSB(X)-7	4.375V	4.175V	2.500V	2.900V	0.075V	0.700V	-0.075V	8.0V	7.3V	Selectable	Auto Release	Option 1	Permission
AP9214L(X)-AH-HSB(X)-7	4.425V	4.225V	2.500V	2.900V	0.075V	0.700V	-0.075V	8.0V	7.3V	Selectable	Auto Release	Option 1	Permission
AP9214L(X)-AI-HSB(X)-7	4.500V	4.300V	2.400V	2.800V	0.150V	0.700V	-0.075V	8.0V	7.3V	Selectable	Auto Release	Option 1	Permission
AP9214L(X)-AJ-HSB(X)-7	4.375V	4.175V	2.400V	2.800V	0.125V	0.700V	-0.125V	8.0V	7.3V	Selectable	Auto Release	Option 1	Permission
AP9214L(X)-AK-HSB(X)-7	4.250V	4.050V	2.400V	3.000V	0.150V	0.700V	-0.150V	8.0V	7.3V	Selectable	Auto Release	Option 1	Permission
AP9214L(X)-AL-HSB(X)-7	4.275V	4.175V	2.300V	2.400V	0.180V	0.700V	-0.180V	8.0V	7.3V	Selectable	Auto Release	Option 1	Permission
AP9214L(X)-AM-HSB(X)-7	4.375V	4.175V	2.300V	2.400V	0.180V	0.700V	-0.180V	8.0V	7.3V	Selectable	Auto Release	Option 1	Permission
AP9214L(X)-AN-HSB(X)-7	4.225V	4.025V	3.200V	3.400V	0.060V	0.450V	-0.060V	8.0V	7.3V	Selectable	Auto Release	Option 1	Permission
AP9214L(X)-BA-HSB(X)-7	4.240V	4.140V	3.000V	3.100V	0.081V	0.700V	-0.081V	8.0V	7.3V	Selectable	Auto Release	Option 1	Permission

Ordering Information (Cont.) (Note 9)

Delay Time Combination

Part Number	Overcharge Detection Delay Time t_{cu}	Overcharge Release Delay Time t_{cur}	Overdischarge Detection Delay Time t_{DL}	Overdischarge Release Delay Time t_{DLR}	Discharge Overcurrent Detection Delay Time t_{DOC}	Discharge Overcurrent Release Delay Time t_{DOCR}	Charge Overcurrent Detection Delay Time t_{COC}	Charge Overcurrent Release Delay Time t_{COCR}	Load Short Detection Delay Time t_{SHORT}
AP9214L(X)-XX- HSB(X)-7	1.0s	2.0ms	115ms	2.0ms	10.0ms	2.0ms	10.0ms	2.0ms	320 μ s

Note: 9. If products of any other voltage versions are needed, please contact with the local sales' office.

Marking Information

(Top View)

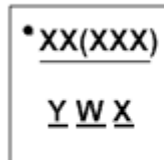

XX(XXX) : Identification Code (2~5 Codes)

Y : Year : 0 to 9

W : Week : A to Z : 1 to 26 week;

a to z : 27 to 52 week; z represents 52 and 53 week

X : Internal Code

NEW PRODUCT

Marking Information (Cont.)

NEW PRODUCT

Part Number	Package	Identification Code
AP9214LA-AA-HSB-7	U-DFN2535-6	14AA
AP9214LA-AB-HSB-7	U-DFN2535-6	14AB
AP9214LA-AC-HSB-7	U-DFN2535-6	14AC
AP9214LA-AD-HSB-7	U-DFN2535-6	14AD
AP9214LA-AE-HSB-7	U-DFN2535-6	14AE
AP9214LA-AF-HSB-7	U-DFN2535-6	14AF
AP9214LA-AG-HSB-7	U-DFN2535-6	S6
AP9214LA-AH-HSB-7	U-DFN2535-6	S8
AP9214LA-AI-HSB-7	U-DFN2535-6	14AI
AP9214LA-AJ-HSB-7	U-DFN2535-6	14AJ
AP9214LA-AK-HSB-7	U-DFN2535-6	14AK
AP9214LA-AL-HSB-7	U-DFN2535-6	14AL
AP9214LA-AM-HSB-7	U-DFN2535-6	14AM
AP9214LA-AN-HSB-7	U-DFN2535-6	14AN
AP9214LA-BA-HSB-7	U-DFN2535-6	14BA
AP9214LA-AA-HSBR-7	U-DFN2535-6	14AAR
AP9214LA-AB-HSBR-7	U-DFN2535-6	14ABR
AP9214LA-AC-HSBR-7	U-DFN2535-6	14ACR
AP9214LA-AD-HSBR-7	U-DFN2535-6	14ADR
AP9214LA-AE-HSBR-7	U-DFN2535-6	14AER
AP9214LA-AF-HSBR-7	U-DFN2535-6	14AFR
AP9214LA-AG-HSBR-7	U-DFN2535-6	R7
AP9214LA-AH-HSBR-7	U-DFN2535-6	RH
AP9214LA-AI-HSBR-7	U-DFN2535-6	14AIR
AP9214LA-AJ-HSBR-7	U-DFN2535-6	14AJR
AP9214LA-AK-HSBR-7	U-DFN2535-6	14AKR
AP9214LA-AL-HSBR-7	U-DFN2535-6	14ALR
AP9214LA-AM-HSBR-7	U-DFN2535-6	14AMR
AP9214LA-AN-HSBR-7	U-DFN2535-6	14ANR
AP9214LA-BA-HSBR-7	U-DFN2535-6	14BAR
AP9214L-AA-HSB-7	U-DFN2535-6	14A
AP9214L-AB-HSB-7	U-DFN2535-6	14B
AP9214L-AC-HSB-7	U-DFN2535-6	14C
AP9214L-AD-HSB-7	U-DFN2535-6	14D
AP9214L-AE-HSB-7	U-DFN2535-6	14E
AP9214L-AF-HSB-7	U-DFN2535-6	14F
AP9214L-AG-HSB-7	U-DFN2535-6	X8
AP9214L-AH-HSB-7	U-DFN2535-6	X9
AP9214L-AI-HSB-7	U-DFN2535-6	14I
AP9214L-AJ-HSB-7	U-DFN2535-6	14J
AP9214L-AK-HSB-7	U-DFN2535-6	14K
AP9214L-AL-HSB-7	U-DFN2535-6	14L
AP9214L-AM-HSB-7	U-DFN2535-6	14M
AP9214L-AN-HSB-7	U-DFN2535-6	14N
AP9214L-AA-HSBR-7	U-DFN2535-6	14AR
AP9214L-AB-HSBR-7	U-DFN2535-6	14BR
AP9214L-AC-HSBR-7	U-DFN2535-6	14CR
AP9214L-AD-HSBR-7	U-DFN2535-6	14DR
AP9214L-AE-HSBR-7	U-DFN2535-6	14ER
AP9214L-AF-HSBR-7	U-DFN2535-6	14FR
AP9214L-AG-HSBR-7	U-DFN2535-6	14GR
AP9214L-AH-HSBR-7	U-DFN2535-6	14HR
AP9214L-AI-HSBR-7	U-DFN2535-6	14IR
AP9214L-AJ-HSBR-7	U-DFN2535-6	14JR
AP9214L-AK-HSBR-7	U-DFN2535-6	14KR
AP9214L-AL-HSBR-7	U-DFN2535-6	14LR
AP9214L-AM-HSBR-7	U-DFN2535-6	14MR
AP9214L-AN-HSBR-7	U-DFN2535-6	14NR

Package Outline Dimensions

Please see <http://www.diodes.com/package-outlines.html> for the latest version.

U-DFN2535-6 (Type B)

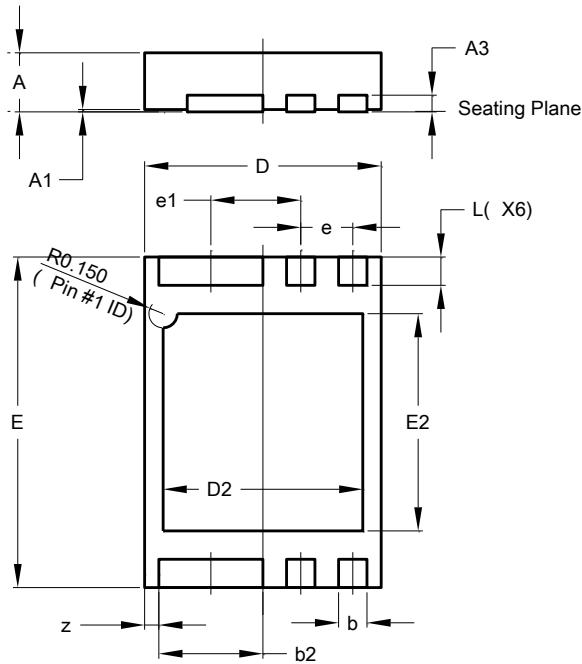

U-DFN2535-6 (Type B)			
Dim	Min	Max	Typ
A	0.50	0.60	-
A1	0.00	0.05	0.02
A3	-	-	0.127
b	0.25	0.35	0.30
b2	1.05	1.15	1.10
D	2.45	2.55	2.50
D2	2.01	2.21	2.11
E	3.45	3.55	3.50
E2	2.20	2.40	2.30
e	-	-	0.55
e1	-	-	0.95
L	0.25	0.35	0.30
z	-	-	0.15
All Dimensions in mm			

NEW PRODUCT

Suggested Pad Layout

Please see <http://www.diodes.com/package-outlines.html> for the latest version.

U-DFN2535-6 (Type B)

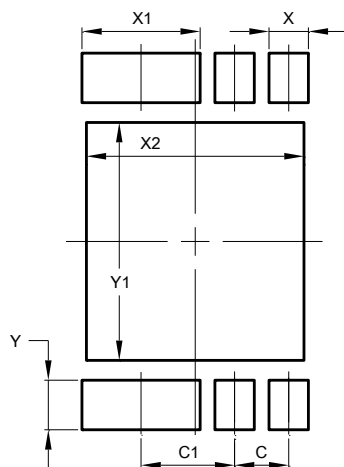

Dimensions	Value (in mm)
C	0.550
C1	0.950
X	0.400
X1	1.200
X2	2.210
Y	0.500
Y1	2.400