

FINAL DATA SHEET

APD Series: Silicon PIN Diode Bondable Chips

Applications

- Switches
- Attenuators

Features

- Established Skyworks PIN diode process
- Low capacitance designs to 0.05 pF
- Voltage ratings to 200 V
- Chip size < 15 mils square
- Tight control of I layer base width
- Mesa and planar chip designs



Skyworks Green™ products are compliant with all applicable legislation and are halogen-free. For additional information, refer to *Skyworks Definition of Green™*, document number SQ04-0074.

Description

Skyworks APD series of silicon PIN diodes are designed for use as switch and attenuator devices in high-performance RF and microwave circuits. The PIN diode designs are useful over a wide range of frequencies from below 100 MHz to beyond 30 GHz. These devices use Skyworks well-established silicon technology resulting in PIN diodes with tightly controlled I-region characteristics.

The low capacitance and low resistance of the APD0505 through APD1520 diodes are ideal for switch applications that require insertion loss and fast switching speed. For switch or attenuator applications requiring high power and low distortion, the thick I-region and high reverse breakdown voltage of the APD2220 is ideal.

The absolute maximum ratings of the APD diode series are provided in Table 1. Electrical specifications are provided in Table 2. Table 3 identifies the die part numbers with their corresponding top contact diameters and die outline drawings. Typical performance characteristics are provided in Figures 1 through 5.

Table 1. APD Series Absolute Maximum Ratings

Parameter	Symbol	Minimum	Maximum	Units
Power dissipation	P _{DIS}		$\frac{\text{Maximum } T_J - \text{Case Temp}}{\text{Thermal Resistance junction-to-case}}$	W
Reverse voltage	V _R		See Voltage Rating column in Table 2	V
Forward current	I _F		200	mA
Operating temperature	T _{OP}	-65	+175	°C
Storage temperature	T _{STG}	-65	+200	°C

ESD HANDLING: Although this device is designed to be as robust as possible, electrostatic discharge (ESD) can damage this device. This device must be protected at all times from ESD when handling or transporting. Static charges may easily produce potentials of several kilovolts on the human body or equipment, which can discharge without detection. Industry-standard ESD handling precautions should be used at all times.

Table 2. APD Series Electrical Specifications¹
(T_{OP} = +25 °C, Unless Otherwise Noted)

Parameter	Junction Capacitance (C _J) V _R = 50 V, 1 MHz (pF)	Junction Capacitance (C _J) V _R = 0 V, 1 MHz (pF)	Series Resistance (R _S), I = 10 mA, 500 MHz (Ω)	Forward Voltage (V _F) I _F = 10 mA (V)	Minority Carrier Lifetime (T _L) I = 10 mA (ns)	Voltage Rating ² (V)	I-Region Thickness (μm)	Thermal Resistance (θ _{JC}) (°C/W)
	Maximum	Typical	Maximum	Typical	Typical	Maximum	Nominal	Maximum
Switching Applications								
APD0505-000	0.05	0.05	2.5	0.93	70	50	5	118
APD0510-000	0.10	0.10	1.5	0.90	90	50	5	76
APD0520-000	0.20	0.18	1.0	0.88	120	50	5	55
APD0805-000	0.05	0.10	2.0	0.89	100	100	8	87
APD0810-000	0.10	0.15	1.5	0.88	160	100	8	60
APD1505-000	0.06 @ 10 V	0.12	2.5	0.88	350	200	15	60
APD1510-000	0.10	0.20	2.0	0.86	300	200	15	56
APD1520-000	0.20	0.25	1.2	0.84	900	200	15	44
Attenuator Applications								
APD2220-000	0.20	0.25	4.0	0.79	700	200	50	18

¹ Performance is guaranteed only under the conditions listed in this table.

² Reverse current is specified at 10 μA maximum at the voltage rating noted. Do not exceed this voltage.

Table 3. APD Series Parts

Part Number	Top Contact Diameter (± 0.5 mils)	Die Drawing
<i>Switching Applications</i>		
APD0505-000	1.50	150-806
APD0510-000	2.30	150-801
APD0520-000	3.05	150-801
APD0805-000	2.25	150-801
APD0810-000	3.05	150-801
APD1505-000	2.75	150-806
APD1510-000	3.50	150-813
APD1520-000	5.00	150-802
<i>Attenuator Applications</i>		
APD2220-000	8.50	149-815

Typical Performance Characteristics at 25 °C

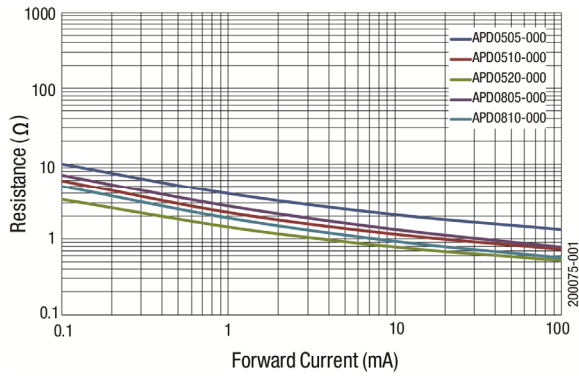

Figure 1. Resistance vs Forward Current @ 500 MHz

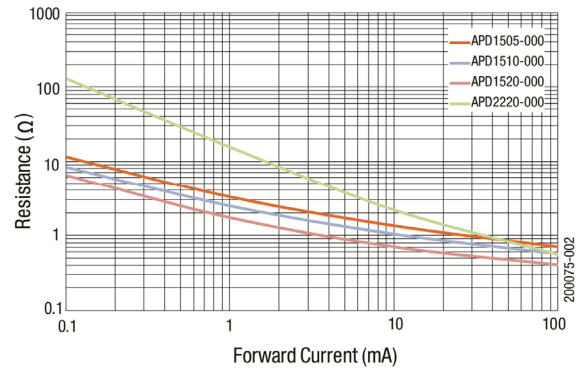

Figure 2. Resistance vs Forward Current @ 500 MHz

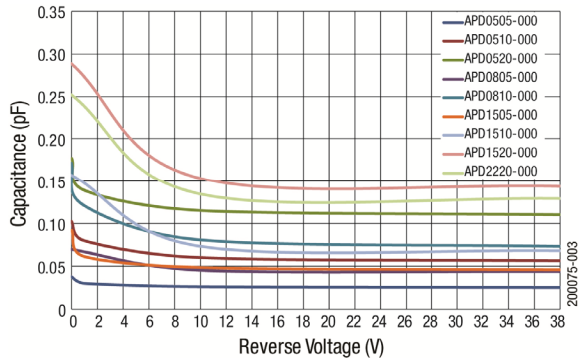

Figure 3. Capacitance vs Reverse Voltage

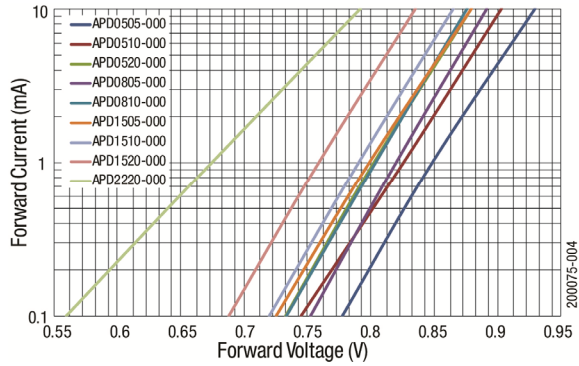

Figure 4. Forward Current vs Forward Voltage

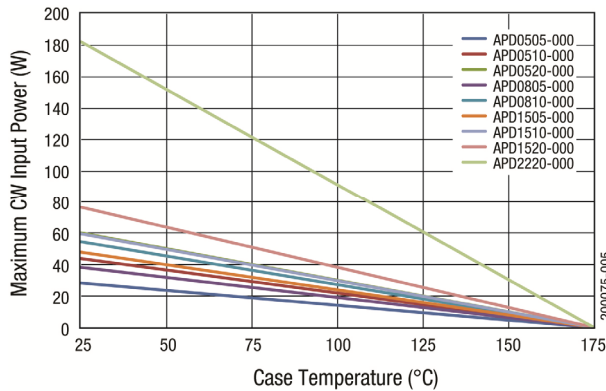

Figure 5. Maximum CW Input Power vs Case Temperature

Package Outline Drawings

Package outline die drawings for the APD diode series are shown in Figures 6 and 7. Additional bonding and handling methods are contained in the Skyworks Application Notes, *Waffle Pack Chip Carrier Handling/Opening Procedure* (document #200146) and

Diode Chips, Beam-Lead Diodes, Capacitors: Bonding Methods and Packaging (document #200532).

Die Packages

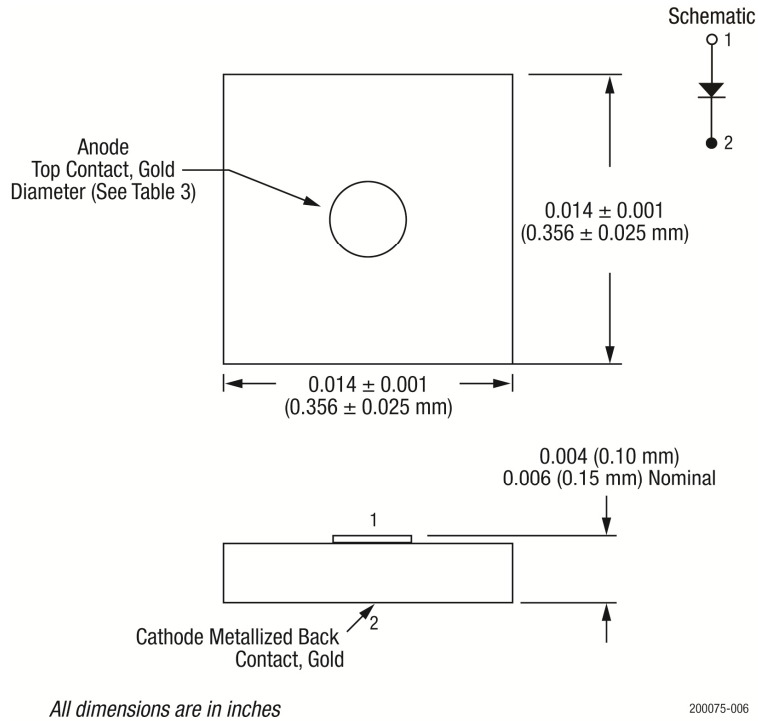

Figure 6. 149-815 Die

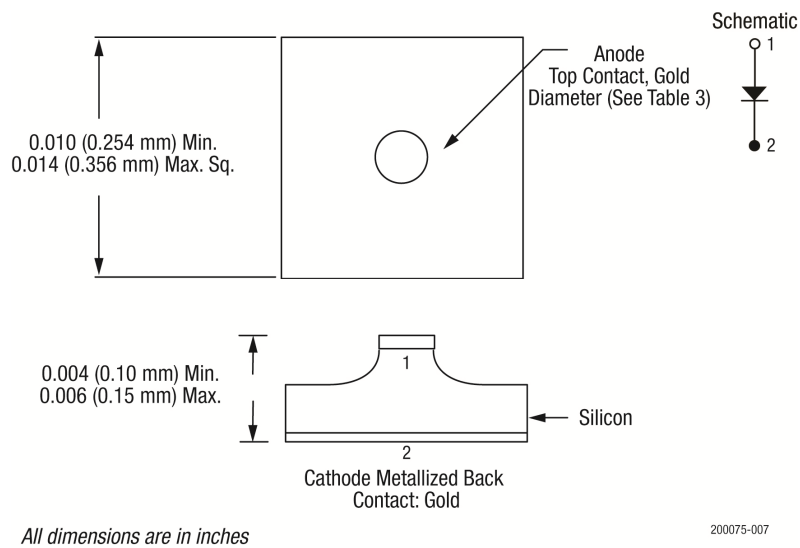

Figure 7. 150 Series Die