

RoHS Compliant

## Serial ATA Flash Drive

SS210-300 Product Specifications

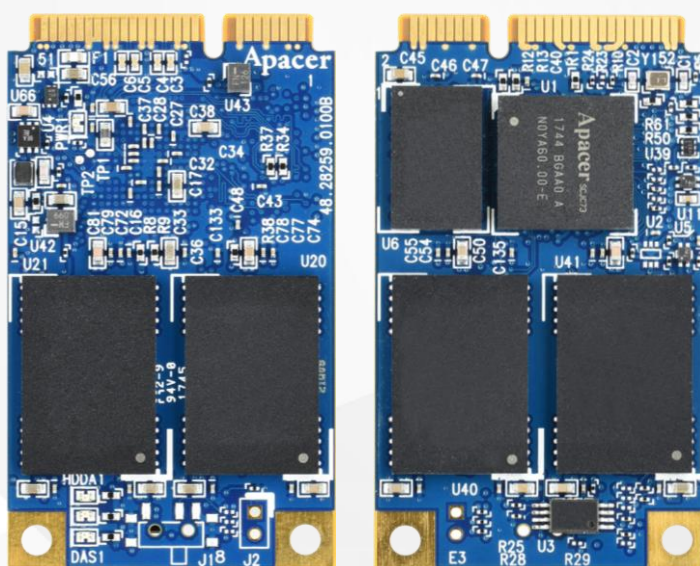

December 26, 2019

Version 1.2



**Apacer Technology Inc.**

1F, No.32, Zhongcheng Rd., Tucheng Dist., New Taipei City, Taiwan, R.O.C

Tel: +886-2-2267-8000 Fax: +886-2-2267-2261

[www.apacer.com](http://www.apacer.com)

## Specifications Overview:

- **Compliance with SATA Revision 3.1**
  - SATA 6.0 Gbps interface
  - Backward compatible with SATA 1.5 and 3.0 Gbps interfaces
  - ATA-8 command set
- **Capacity**
  - 2, 4, 8, 16, 32, 64, 128 GB
- **Performance\***
  - Burst read/write: 600 MB/sec
  - Sequential read: Up to 555 MB/sec
  - Sequential write: Up to 450 MB/sec
  - Random read (4K): Up to 86,000 IOPS
  - Random write (4K): Up to 74,000 IOPS
- **Flash Management**
  - Built-in hardware ECC
  - Global Wear Leveling
  - Flash bad-block management
  - Flash Translation Layer: Page Mapping
  - S.M.A.R.T.
  - Power Failure Management
  - Device Sleep
  - ATA Secure Erase
  - TRIM
- **NAND Flash Type: SLC**
- **MTBF: >2,000,000 hours**
- **Endurance (in Terabytes Written: TBW)**
  - 2 GB: 80 TBW
  - 4 GB: 160 TBW
  - 8 GB: 320 TBW
  - 16 GB: 641 TBW
  - 32 GB: 1,282 TBW
  - 64 GB: 2,565 TBW
  - 128 GB: 5,131 TBW
- **Temperature Range**
  - Operating:
    - Standard: 0°C to 70°C
    - Wide: -40°C to 85°C
  - Storage: -40°C to 100°C
- **Supply Voltage**
  - 3.3 V ± 5%
- **Power Consumption\***
  - Active mode: 665 mA
  - Idle mode: 80 mA
- **Form Factor**
  - JEDEC MO-300
  - Dimensions: 50.80 x 29.85 x 3.8, unit: mm
- **Shock & Vibration\*\***
  - Shock: 1,500 G
  - Vibration: 15 G
- **Reliability**
  - Thermal Sensor
- **SATA Power Management Modes**
- **DRAM Cache for Enhanced Random Performance**
- **Write Protect Switch (optional)**
- **LED Indicators for Drive Behavior**
- **RoHS Compliant**

\*Varies from capacities. The values for performances and power consumptions presented are typical and may vary depending on flash configurations or platform settings. The term idle refers to the standby state of the device.

\*\*Non-operating

## Table of Contents

<b>1. General Descriptions .....</b>	<b>4</b>
1.1 Introduction .....	4
1.2 Capacity .....	4
1.3 Performance .....	4
1.4 Pin Assignments .....	5
1.5 LED Indicator Behavior .....	7
<b>2. Software Interface .....</b>	<b>8</b>
2.1 Command Set .....	8
2.2 S.M.A.R.T. ....	8
<b>3. Flash Management .....</b>	<b>10</b>
3.1 Error Correction/Detection .....	10
3.2 Bad Block Management .....	10
3.3 Global Wear Leveling .....	10
3.4 Flash Translation Layer – Page Mapping .....	10
3.5 ATA Secure Erase .....	10
3.6 Power Failure Management .....	11
3.7 TRIM .....	11
3.8 SATA Power Management .....	11
3.9 DEVSLP (DevSleep or DEVSLP) Mode .....	12
<b>4. Reliability Features .....</b>	<b>13</b>
4.1 Thermal Sensor .....	13
<b>5. Reliability Specifications .....</b>	<b>14</b>
5.1 Environmental Specifications .....	14
5.2 Mean Time Between Failures (MTBF) .....	14
5.3 Certification and Compliance .....	14
5.4 Endurance .....	15
<b>6. Electrical Specifications .....</b>	<b>16</b>
6.1 Operating Voltage .....	16
6.2 Power Consumption .....	16
<b>7. Physical Characteristics .....</b>	<b>17</b>
7.1 Dimensions .....	17

7.2 Write Protect Switch (optional) .....	18
<b>8. Product Ordering Information .....</b>	<b>19</b>
8.1 Product Code Designations .....	19
8.2 Valid Combinations .....	20

# 1. General Descriptions

## 1.1 Introduction

Apacer SS210-300 is a well-balanced solid-state disk (SSD) drive with compact form factor (JEDEC MO-300) and great performance. Designed in SATA 6.0 Gbps interface, the mSATA SSD is able to deliver exceptional read/write speed, making it the ideal companion for heavy-loading embedded or server operations with space constraints for host computing systems. For data efficiency, the internal controlling unit of the mSATA SSD is engineered with DRAM for enhanced random performance. In regard of reliability, the drive comes with various implementations including powerful hardware ECC engine, power saving modes, wear leveling, flash block management, S.M.A.R.T., TRIM, and power failure management.

## 1.2 Capacity

Capacity specifications of SS210-300 are available as shown in Table 1-1. It lists the specific capacity and the default numbers of heads, sectors and cylinders for each product line.

**Table 1-1** Capacity Specifications

Capacity	Total bytes*	Cylinders	Heads	Sectors	Max LBA
2 GB	2,011,226,112	3,897	16	63	3,928,176
4 GB	4,011,614,208	7,773	16	63	7,835,184
8 GB	8,012,390,400	15,525	16	63	15,649,200
16 GB	16,013,942,784	16,383	16	63	31,277,232
32 GB	32,017,047,552	16,383	16	63	62,533,296
64 GB	64,023,257,088	16,383	16	63	125,045,424
128 GB	128,035,676,160	16,383	16	63	250,069,680

\*Display of total bytes varies from file systems, which means not all of the bytes can be used for storage.

\*\*Notes: 1 GB = 1,000,000,000 bytes; 1 sector = 512 bytes.

LBA count addressed in the table above indicates total user storage capacity and will remain the same throughout the lifespan of the device. However, the total usable capacity of the SSD is most likely to be less than the total physical capacity because a small portion of the capacity is reserved for device maintenance usages.

## 1.3 Performance

Performance of SS210-300 is listed below in Table 1-2.

**Table 1-2** Performance Specifications

Performance	Capacity	2 GB	4 GB	8 GB	16 GB	32 GB	64 GB	128 GB
	<b>Sequential Read* (MB/s)</b>		60	125	135	125	555	555
<b>Sequential Write* (MB/s)</b>		28	55	110	75	255	440	450
<b>Random Read IOPS** (4K)</b>		13,000	25,000	25,000	23,000	79,000	81,000	86,000
<b>Random Write IOPS** (4K)</b>		1,000	3,000	6,000	13,000	58,000	72,000	74,000

Note:

Results may differ from various flash configurations or host system setting.

\*Sequential performance is based on CrystalDiskMark 5.2.1 with file size 1,000MB.

\*\*Random performance measured using IOMeter with Queue Depth 32.

## 1.4 Pin Assignments

Pin assignment of the SS210-300 is shown in Figure 1-1 and described in Table 1-3.

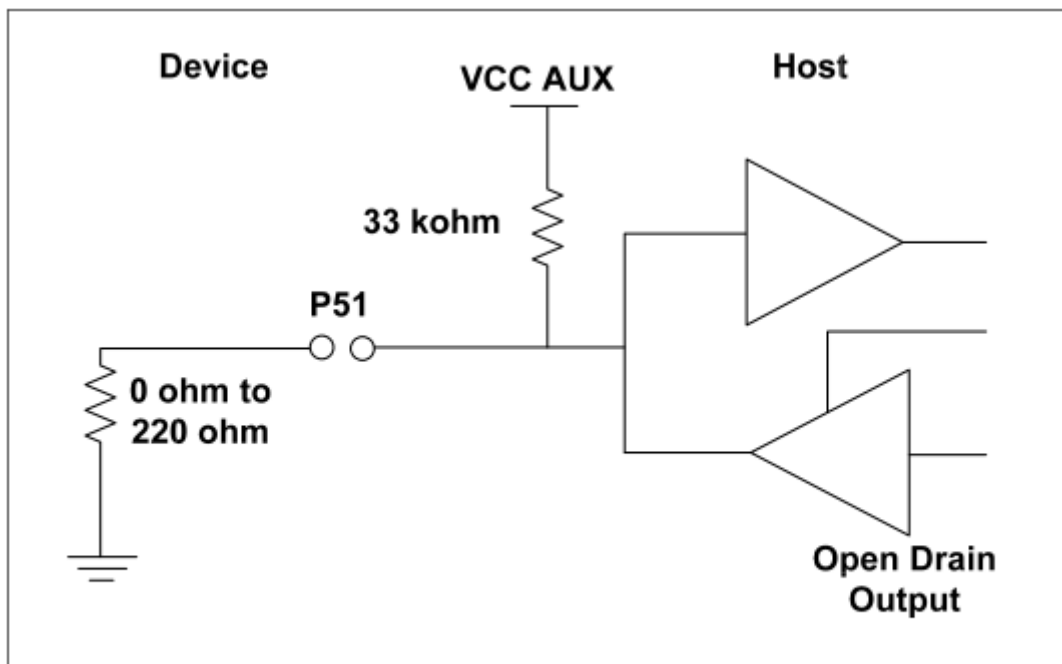

Figure 1-1 Pin Assignment

Table 1-3 Pin Assignment Description

Pin	Type	Description	Pin	Type	Description
1	Reserved	No Connect	27	GND	Ground
2	+3.3V	3.3V source	28	Reserved	No Connect
3	Reserved	No Connect	29	GND	Ground
4	GND	Ground	30	Reserved	No Connect
5	Reserved	No Connect	31	-A	Host Transmitter Differential Signal Pair
6	Reserved	No Connect	32	Reserved	No Connect
7	Reserved	No Connect	33	+A	Host Transmitter Differential Signal Pair
8	Reserved	No Connect	34	GND	Ground
9	GND	Ground	35	GND	Ground
10	Reserved	No Connect	36	Reserved	No Connect
11	Reserved	No Connect	37	GND	Ground
12	Reserved	No Connect	38	Reserved	No Connect
13	Reserved	No Connect	39	+3.3V	3.3V source
14	Reserved	No Connect	40	GND	Ground
15	GND	Ground	41	+3.3V	3.3V source
16	Reserved	No Connect	42	Reserved	No Connect
17	Reserved	No Connect	43	Device Type	No Connect
18	GND	Ground	44	DEVSLP	Device Sleep
19	Reserved	No Connect	45	Reserved	No Connect
20	Reserved	No Connect	46	Reserved	No Connect
21	GND	Ground	47	Reserved	No Connect
22	Reserved	No Connect	48	Reserved	No Connect
23	+B	Host Receiver Differential Signal Pair	49	DAS/DSS	Device Activity Signal/Disable Staggered Spin-up
24	+3.3V	3.3V Source	50	GND	Ground
25	-B	Host Receiver Differential Signal Pair	51*	Detect	0 ohm
26	GND	Ground	52	+3.3V	3.3V source

\*Notes about Pin51: It is a presence detection pin that shall be connected to GND by a 0 ohm to 220 ohm Resistor on device. Please see the diagram below.



**BI-directional host-side Implementation of P51 for compatibility with non-mSATA devices (Informative)**

## 1.5 LED Indicator Behavior

The behavior of the SS210-300 LED indicators is described in Table 1-4.

**Table 1-4** LED Behavior

Location	Status	Description
LED A	Blinking	Accessing drive
	Static	Write Protect is enabled (only available for models supporting write protection)
LED B	Static	PHY is connected

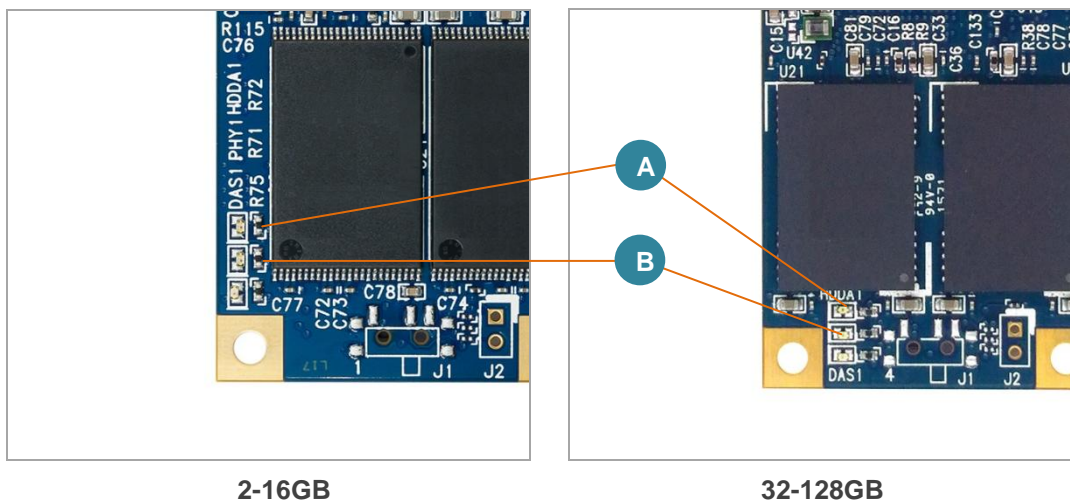



## 2. Software Interface

### 2.1 Command Set

Table 2-1 summarizes the ATA commands supported by SS210-300.

**Table 2-1** Command Set

Code	Command	Code	Command
E5h	Check Power Mode	F6h	Security Disable Password
90h	Execute Diagnostics	F3h	Security Erase Prepare
E7h	Flush Cache	F4h	Security Erase Unit
ECh	Identify Device	F5h	Security Freeze Lock
E3h	Idle	F1h	Security Set Password
E1h	Idle Immediate	F2h	Security Unlock
91h	Initialize Device Parameters	7Xh	Seek
C8h	Read DMA	EFh	Set Features
25h	Read DMA EXT	C6h	Set Multiple Mode
60h	Read FPDMA Queued	E6h	Sleep
47h	Read Log DMA EXT	B0h	S.M.A.R.T.
2Fh	Read Log EXT	E2h	Standby
C4h	Read Multiple	E0h	Standby Immediate
20 or 21h	Read Sector(s)	CAh	Write DMA
40 or 41h	Read Verify Sector(s)	35h	Write DMA EXT
10h	Recalibrate	61h	Write FPDMA Queued
57h	Write Log DMA EXT	3Fh	Write Log EXT
C5h	Write Multiple	30h or 31h	Write Sector(s)

### 2.2 S.M.A.R.T.

S.M.A.R.T. is an abbreviation for Self-Monitoring, Analysis and Reporting Technology, a self-monitoring system that provides indicators of drive health as well as potential disk problems. It serves as a warning for users from unscheduled downtime by monitoring and displaying critical drive information. Ideally, this should allow taking proactive actions to prevent drive failure and make use of S.M.A.R.T. information for future product development reference.

Apacer devices use the standard SMART command B0h to read data out from the drive to activate our S.M.A.R.T. feature that complies with the ATA/ATAPI specifications. S.M.A.R.T. Attribute IDs shall include initial bad block count, total later bad block count, maximum erase count, average erase count, power on hours and power cycle. When the S.M.A.R.T. Utility running on the host, it analyzes and reports the disk status to the host before the device reaches in critical condition.

Note: Attribute IDs may vary from product models due to various solution design and supporting capabilities.

Apacer memory products come with S.M.A.R.T. commands and subcommands for users to obtain information of drive status and to predict potential drive failures. Users can take advantage of the following commands/subcommands to monitor the health of the drive.

Code	SMART Subcommand
D0h	READ DATA
D1h	READ ATTRIBUTE THRESHOLDS
D2h	Enable/Disable Attribute Autosave
D4h	Execute Off-line Immediate
D5h	Read Log (optional)
D6h	Write Log (optional)
D8h	Enable Operations
D9h	Disable operations
DAh	Return Status

### General SMART attribute structure

Byte	Description
0	ID (Hex)
1 – 2	Status flag
3	Value
4	Worst
5*-11	Raw Data

\*Byte 5: LSB

### SMART attribute ID list

ID (Hex)	Attribute Name
9 (0x09)	Power-on hours
12 (0x0C)	Power cycle count
163 (0xA3)	Max. erase count
164 (0xA4)	Avg. erase count
166 (0xA6)	Total later bad block count
167 (0xA7)	SSD Protect Mode (vendor specific)
168 (0xA8)	SATA PHY Error Count
175 (0xAF)	Bad Cluster Table Count
192 (0xC0)	Unexpected Power Loss Count
194 (0xC2)	Temperature
241 (0xF1)	Total sectors of write

## 3. Flash Management

### 3.1 Error Correction/Detection

SS210-300 implements a hardware ECC scheme, based on the BCH algorithm. It can detect and correct up to 40 bits error in 1K bytes.

### 3.2 Bad Block Management

Current production technology is unable to guarantee total reliability of NAND flash memory array. When a flash memory device leaves factory, it comes with a minimal number of initial bad blocks during production or out-of-factory as there is no currently known technology that produce flash chips free of bad blocks. In addition, bad blocks may develop during program/erase cycles. When host performs program/erase command on a block, bad block may appear in Status Register. Since bad blocks are inevitable, the solution is to keep them in control. Apacer flash devices are programmed with ECC, page mapping technique and S.M.A.R.T to reduce invalidity or error. Once bad blocks are detected, data in those blocks will be transferred to free blocks and error will be corrected by designated algorithms.

### 3.3 Global Wear Leveling

Flash memory devices differ from Hard Disk Drives (HDDs) in terms of how blocks are utilized. For HDDs, when a change is made to stored data, like erase or update, the controller mechanism on HDDs will perform overwrites on blocks. Unlike HDDs, flash blocks cannot be overwritten and each P/E cycle wears down the lifespan of blocks gradually. Repeatedly program/erase cycles performed on the same memory cells will eventually cause some blocks to age faster than others. This would bring flash storages to their end of service term sooner. Global wear leveling is an important mechanism that levels out the wearing of all blocks so that the wearing-down of all blocks can be almost evenly distributed. This will increase the lifespan of SSDs.

### 3.4 Flash Translation Layer – Page Mapping

Page mapping is an advanced flash management technology whose essence lies in the ability to gather data, distribute the data into flash pages automatically, and then schedule the data to be evenly written. Page-level mapping uses one page as the unit of mapping. The most important characteristic is that each logical page can be mapped to any physical page on the flash memory device. This mapping algorithm allows different sizes of data to be written to a block as if the data is written to a data pool and it does not need to take extra operations to process a write command. Thus, page mapping is adopted to increase random access speed and improve SSD lifespan, reduce block erase frequency, and achieve optimized performance and lifespan.

### 3.5 ATA Secure Erase

ATA Secure Erase is an ATA disk purging command currently embedded in most of the storage drives. Defined in ATA specifications, (ATA) Secure Erase is part of Security Feature Set that allows storage drives to erase all user data areas. The erase process usually runs on the firmware level as most of the ATA-based storage media currently in the market are built-in with this command. ATA Secure Erase can securely wipe out the user data in the drive and protects it from malicious attack.

### 3.6 Power Failure Management

Power Failure Management plays a crucial role when power supply becomes unstable. Power disruption may occur when users are storing data into the SSD, leading to instability in the drive. However, with Power Failure Management, a firmware protection mechanism will be activated to scan pages and blocks once power is resumed. Valid data will be transferred to new blocks for merging and the mapping table will be rebuilt. Therefore, data reliability can be reinforced, preventing damage to data stored in the NAND Flash.

Note: The controller unit of this product model is designed with a DRAM as a write cache for improved performance and data efficiency. Though unlikely to happen in most cases, the data cached in the volatile DRAM might be potentially affected if a sudden power loss takes place before the cached data is flushed into non-volatile NAND flash memory.

### 3.7 TRIM

TRIM is a SATA command that helps improve the read/write performance and efficiency of solid-state drives (SSD). The command enables the host operating system to inform SSD controller which blocks contain invalid data, mostly because of the erase commands from host. The invalid will be discarded permanently and the SSD will retain more space for itself.

### 3.8 SATA Power Management

By complying with SATA 6.0 Gb/s specifications, the SSD supports the following SATA power saving modes:

- ACTIVE: PHY ready, full power, Tx & Rx operational
- PARTIAL: Reduces power, resumes in under 10  $\mu$ s (microseconds)
- SLUMBER: Reduces power, resumes in under 10 ms (milliseconds)
- HIPM: Host-Initiated Power Management
- DIPM: Device-Initiated Power Management
- AUTO-SLUMBER: Automatic transition from partial to slumber.
- Device Sleep (DevSleep or DEVSLP): PHY powered down; power consumption  $\leq$  5 mW; host assertion time  $\leq$  10 ms; exit timeout from this state  $\leq$  20 ms (unless specified otherwise in SATA Identify Device Log).

Note: The behaviors of power management features would depend on host/device settings.

### 3.9 DEVSLP (DevSleep or DEVSLP) Mode

Device Sleep is a feature that allows SATA devices to enter a low power mode by designating a particular pin as DEVSLP signal with an aim to reducing power consumption.

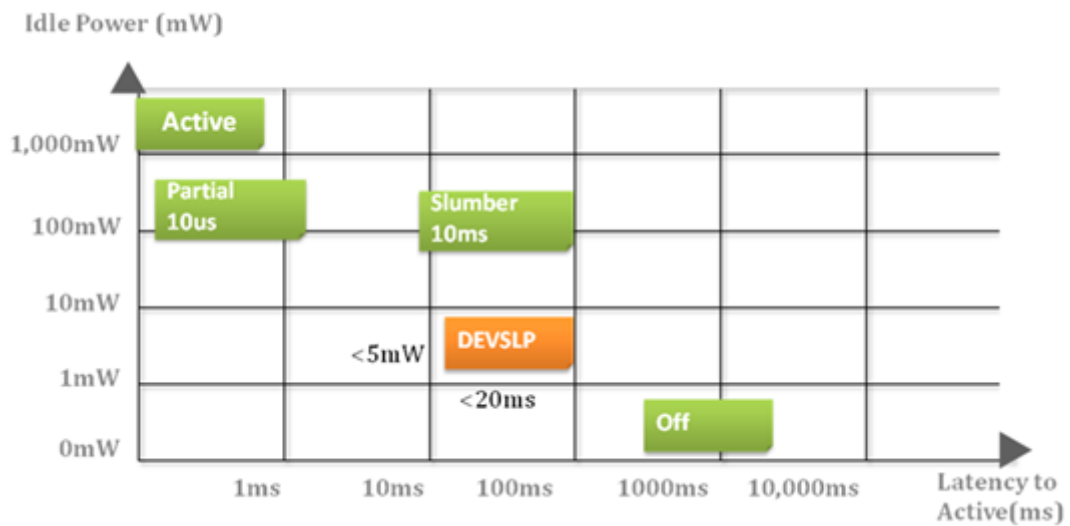

## 4. Reliability Features

### 4.1 Thermal Sensor

Apacer Thermal Sensor is a digital temperature sensor with serial interface. By using a designated pin for transmission, storage device owners are able to read temperature data.

## 5. Reliability Specifications

### 5.1 Environmental Specifications

Environmental specifications of SS210-300 product are shown in Table 5-1.

**Table 5-1** Environmental Specifications

Environment	Specifications
Temperature	0°C to 70°C (Standard); -40°C to 85°C (Wide)
	-40°C to 100°C (Non-operating)
Vibration	Non-operating: Sine wave, 15(G), 10~2000(Hz), Operating: Random, 7.69(GRMS), 20~2000(Hz)
Shock	Non-operating: Acceleration, 1,500 G, 0.5 ms Operating: Peak acceleration, 50 G, 11 ms

### 5.2 Mean Time Between Failures (MTBF)

Mean Time Between Failures (MTBF) is predicted based on reliability data for the individual components in SS210-300. The prediction result for SS210-300 is more than 2,000,000 hours.

Note: The MTBF is predicated and calculated based on “Telcordia Technologies Special Report, SR-332, Issue 2” method.

### 5.3 Certification and Compliance

SS210-300 complies with the following standards:

- CE
- FCC
- RoHS
- MIL-STD-810F

## 5.4 Endurance

The endurance of a storage device is predicted by TeraBytes Written based on several factors related to usage, such as the amount of data written into the drive, block management conditions, and daily workload for the drive. Thus, key factors, such as Write Amplifications and the number of P/E cycles, can influence the lifespan of the drive.

**Table 5-2** Endurance Specifications

Capacity	TeraBytes Written
2 GB	80
4 GB	160
8 GB	320
16 GB	641
32 GB	1,282
64 GB	2,565
128 GB	5,131

Note:

- The measurement assumes the data written to the SSD for test is under a typical and constant rate.
- The measurement follows the standard metric: 1 TB (Terabyte) = 1,000 GB.
- This estimation complies with JEDEC JESD-219, enterprise endurance workload of random data with payload size distribution.



## 6. Electrical Specifications

### 6.1 Operating Voltage

Table 6-1 lists the supply voltage for SS210-300.

**Table 6-1** Operating Range

Item	Range
Supply Voltage	3.3V ± 5%

### 6.2 Power Consumption

Table 6-2 lists the power consumption for SS210-300.

**Table 6-2** Power Consumption

Capacity Mode	2 GB	4 GB	8 GB	16 GB	32 GB	64 GB	128 GB
<b>Active (mA)</b>	215	270	380	265	425	625	665
<b>Idle (mA)</b>	80	80	85	80	80	80	80

Note:

\*All values are typical and may vary depending on flash configurations or host system settings.

\*\*Active power is an average power measurement performed using CrystalDiskMark with 128KB sequential read/write transfers.

## 7. Physical Characteristics

### 7.1 Dimensions

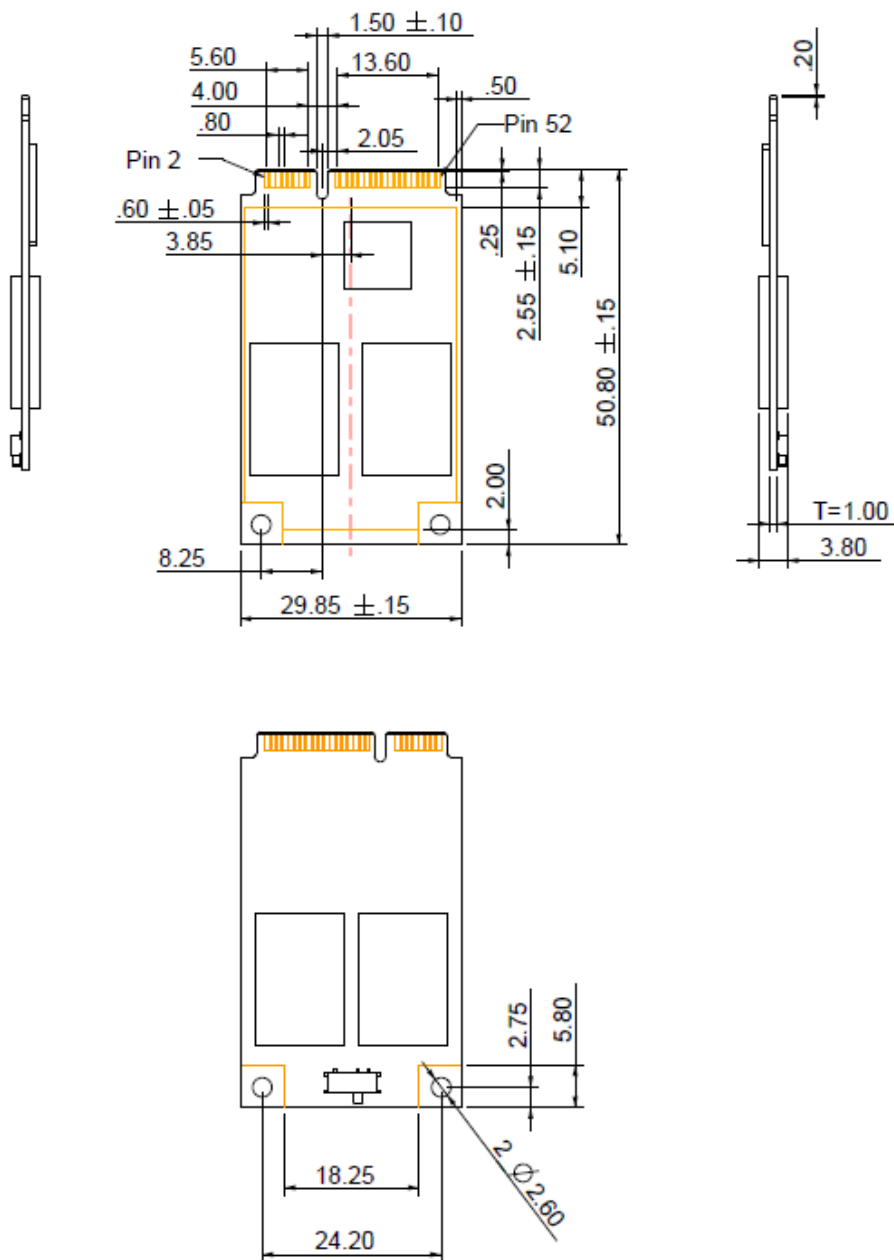

Unit: mm  
Tolerance:  $\pm 0.2$

## 7.2 Write Protect Switch (optional)

Apacer implements the Virtual Write scheme that allows write commands to go through the flash controller and data temporarily stored, but no data has been actually written into the flash. Once the system is reset and rebooted, the temporarily stored data will be lost and nowhere to be found in the system. Since the Virtual Write scheme runs at device level, it requires no software or driver installation and is independent from the host OS.

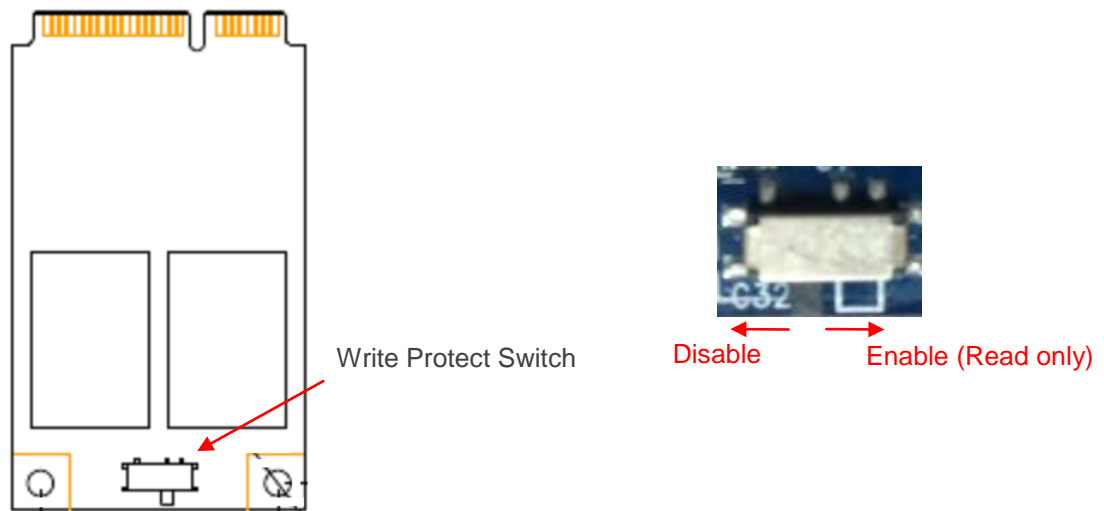

Note: Write Protect is optional and the image is for reference only.

## 8. Product Ordering Information

### 8.1 Product Code Designations

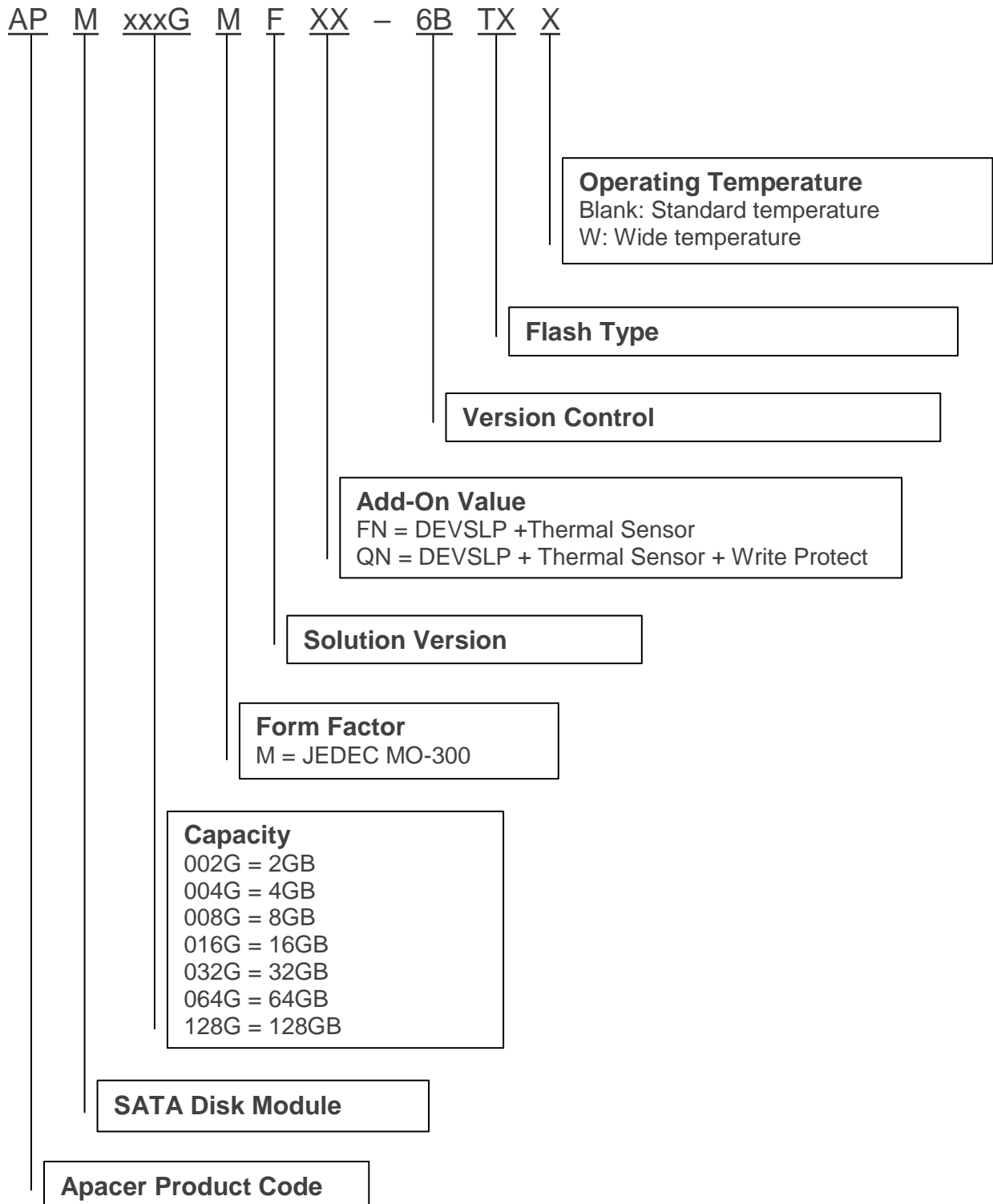

## 8.2 Valid Combinations

### 8.2.1 Without Write Protect

Capacity	Standard Temperature	Wide Temperature
2GB	APM002GMFFN-6BT	APM002GMFFN-6BTW
4GB	APM004GMFFN-6BT	APM004GMFFN-6BTW
8GB	APM008GMFFN-6BT	APM008GMFFN-6BTW
16GB	APM016GMFFN-6BT	APM016GMFFN-6BTW
32GB	APM032GMFFN-6BTG	APM032GMFFN-6BTGW
64GB	APM064GMFFN-6BTG	APM064GMFFN-6BTGW
128GB	APM128GMFFN-6BTG	APM128GMFFN-6BTGW

### 8.2.2 With Write Protect

Capacity	Standard Temperature	Wide Temperature
2GB	APM002GMFQN-6BT	APM002GMFQN-6BTW
4GB	APM004GMFQN-6BT	APM004GMFQN-6BTW
8GB	APM008GMFQN-6BT	APM008GMFQN-6BTW
16GB	APM016GMFQN-6BT	APM016GMFQN-6BTW
32GB	APM032GMFQN-6BTG	APM032GMFQN-6BTGW
64GB	APM064GMFQN-6BTG	APM064GMFQN-6BTGW
128GB	APM128GMFQN-6BTG	APM128GMFQN-6BTGW

**Note:** Valid combinations are those products in mass production or will be in mass production. Consult your Apacer sales representative to confirm availability of valid combinations and to determine availability of new combinations.

## Revision History

Revision	Description	Date
1.0	Official release	6/14/2018
1.1	- Updated product photos on the cover page - Updated 4.1 Thermal Sensor	7/9/2018
1.2	- Renamed extended temperature to wide temperature - Updated Performance and Power Consumption on Specifications Overview page - Updated the technology description for 3.6 Power Failure Management - Updated 1.3 Performance and 6.2 Power Consumption - Updated 8. Product Ordering Information due to FW change	12/26/2019