

## Thunderbolt® High Speed NPT IGBT with Anti-Parallel 'DQ' Diode

The Thunderbolt HS™ series is based on thin wafer non-punch through (NPT) technology similar to the Thunderbolt® series, but trades higher  $V_{CE(ON)}$  for significantly lower turn-on energy  $E_{off}$ . The low switching losses enable operation at switching frequencies over 100kHz, approaching power MOSFET performance but lower cost.

An extremely tight parameter distribution combined with a positive  $V_{CE(ON)}$  temperature coefficient make it easy to parallel Thunderbolts HS™ IGBT's. Controlled slew rates result in very good noise and oscillation immunity and low EMI. The short circuit duration rating of 10 $\mu$ s make these IGBT's suitable for motor drive and inverter applications. Reliability is further enhanced by avalanche energy ruggedness. Combi versions are packaged with a high speed, soft recovery DQ series diode.

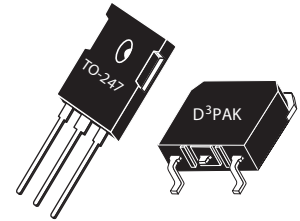

APT30GS60BRDQ2(G)

APT30GS60SRDQ2(G)

Single die IGBT with separate DQ diode die

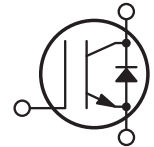

### Features

- Fast Switching with low EMI
- Very Low  $E_{OFF}$  for Maximum Efficiency
- Short circuit rated
- Low Gate Charge
- Tight parameter distribution
- Easy paralleling
- RoHS Compliant 

### Typical Applications

- ZVS Phase Shifted and other Full Bridge
- Half Bridge
- High Power PFC Boost
- Welding
- Induction heating
- High Frequency SMPS

### Absolute Maximum Ratings

Symbol	Parameter	Rating	Unit
$I_{C1}$	Continuous Collector Current $T_C = @ 25^\circ C$	54	A
$I_{C2}$	Continuous Collector Current $T_C = @ 100^\circ C$	30	
$I_{CM}$	Pulsed Collector Current <sup>①</sup>	113	
$V_{GE}$	Gate-Emitter Voltage	$\pm 30V$	V
SSOA	Switching Safe Operating Area	113	
$E_{AS}$	Single Pulse Avalanche Energy <sup>②</sup>	20	mJ
$t_{SC}$	Short Circuit Withstand Time <sup>②</sup>	10	$\mu$ s
$I_F$	Diode Continuous Forward Current	$T_C = 25^\circ C$	90
		$T_C = 100^\circ C$	55
$I_{FRM}$	Diode Max. Repetitive Forward Current	113	A

### Thermal and Mechanical Characteristics

Symbol	Parameter	Min	Typ	Max	Unit
$P_D$	Total Power Dissipation $T_C = @ 25^\circ C$			250	W
$R_{\theta JC}$	Junction to Case Thermal Resistance	IGBT		0.50	$^\circ C/W$
		Diode		0.67	
$R_{\theta CS}$	Case to Sink Thermal Resistance, Flat Greased Surface		0.11		
$T_J, T_{STG}$	Operating and Storage Junction Temperature Range	-55		150	$^\circ C$
$T_L$	Soldering Temperature for 10 Seconds (1.6mm from case)			300	
$W_T$	Package Weight		0.22		oz
			5.9		g
Torque	Mounting Torque (TO-247), 6-32 M3 Screw			10	in·lbf
				1.1	N·m

 **CAUTION:** These Devices are Sensitive to Electrostatic Discharge. Proper Handling Procedures Should be Followed.

**Static Characteristics**
**T<sub>J</sub> = 25°C unless otherwise specified**
**APT30GS60B\_SRDQ2(G)**

Symbol	Parameter	Test Conditions	Min	Typ	Max	Unit
V <sub>BR(CES)</sub>	Collector-Emitter Breakdown Voltage	V <sub>GE</sub> = 0V, I <sub>C</sub> = 250μA	600			V
ΔV <sub>BR(CES)</sub> /ΔT <sub>J</sub>	Breakdown Voltage Temperature Coeff	Reference to 25°C, I <sub>C</sub> = 250μA		0.60		V/°C
V <sub>CE(ON)</sub>	Collector-Emitter On Voltage <sup>③</sup>	V <sub>GE</sub> = 15V I <sub>C</sub> = 30A	T <sub>J</sub> = 25°C	2.8	3.15	V
			T <sub>J</sub> = 125°C	3.25		
V <sub>EC</sub>	Diode Forward Voltage <sup>③</sup>	I <sub>C</sub> = 30A	T <sub>J</sub> = 25°C	1.85		
			T <sub>J</sub> = 125°C	1.5		
V <sub>GE(th)</sub>	Gate-Emitter Threshold Voltage	V <sub>GE</sub> = V <sub>CE</sub> , I <sub>C</sub> = 1mA	3	4	5	mV/°C
ΔV <sub>GE(th)</sub> /ΔT <sub>J</sub>	Threshold Voltage Temp Coeff			6.7		
I <sub>CES</sub>	Zero Gate Voltage Collector Current	V <sub>CE</sub> = 600V, V <sub>GE</sub> = 0V	T <sub>J</sub> = 25°C		50	μA
			T <sub>J</sub> = 125°C		1000	
I <sub>GES</sub>	Gate-Emitter Leakage Current	V <sub>GE</sub> = ±20V			±100	nA

**Dynamic Characteristics**
**T<sub>J</sub> = 25°C unless otherwise specified**

Symbol	Parameter	Test Conditions	Min	Typ	Max	Unit
g <sub>fs</sub>	Forward Transconductance	V <sub>CE</sub> = 50V, I <sub>C</sub> = 30A		18		S
C <sub>ies</sub>	Input Capacitance	V <sub>GE</sub> = 0V, V <sub>CE</sub> = 25V f = 1MHz		1600		pF
C <sub>oes</sub>	Output Capacitance			140		
C <sub>res</sub>	Reverse Transfer Capacitance			90		
C <sub>o(cr)</sub>	Reverse Transfer Capacitance Charge Related <sup>④</sup>	V <sub>GE</sub> = 0V V <sub>CE</sub> = 0 to 400V		130		
C <sub>o(er)</sub>	Reverse Transfer Capacitance Current Related <sup>⑤</sup>			95		
Q <sub>g</sub>	Total Gate Charge	V <sub>GE</sub> = 0 to 15V I <sub>C</sub> = 30A, V <sub>CE</sub> = 300V		145		nC
Q <sub>ge</sub>	Gate-Emitter Charge			12		
G <sub>gc</sub>	Gate-Collector Charge			65		
t <sub>d(on)</sub>	Turn-On Delay Time	Inductive Switching IGBT and Diode:  T <sub>J</sub> = 25°C, V <sub>CC</sub> = 400V, I <sub>C</sub> = 30A R <sub>G</sub> = 9.1Ω <sup>⑥</sup> , V <sub>GG</sub> = 15V		16		ns
t <sub>r</sub>	Rise Time			29		
t <sub>d(off)</sub>	Turn-Off Delay Time			360		
t <sub>f</sub>	Fall Time			27		
E <sub>on1</sub>	Turn-On Switching Energy <sup>⑦</sup>			TBD		
E <sub>on2</sub>	Turn-On Switching Energy <sup>⑧</sup>	Inductive Switching IGBT and Diode:  T <sub>J</sub> = 125°C, V <sub>CC</sub> = 400V, I <sub>C</sub> = 30A R <sub>G</sub> = 9.1Ω <sup>⑥</sup> , V <sub>GG</sub> = 15V		800		μJ
E <sub>off</sub>	Turn-Off Switching Energy <sup>⑨</sup>			570		
t <sub>d(on)</sub>	Turn-On Delay Time			16		
t <sub>r</sub>	Rise Time		29		ns	
t <sub>d(off)</sub>	Turn-Off Delay Time		390			
t <sub>f</sub>	Fall Time		22			
E <sub>on1</sub>	Turn-On Switching Energy <sup>⑦</sup>		TBD		μJ	
E <sub>on2</sub>	Turn-On Switching Energy <sup>⑧</sup>		1185			
E <sub>off</sub>	Turn-Off Switching Energy <sup>⑨</sup>		695			
t <sub>rr</sub>	Diode Reverse Recovery Time	I <sub>F</sub> = 40A V <sub>R</sub> = 400V di <sub>F</sub> /dt = 200A/μs		25		ns
Q <sub>rr</sub>	Diode Reverse Recovery Charge			35		nC
I <sub>rrm</sub>	Peak Reverse Recovery Current			3		A

**TYPICAL PERFORMANCE CURVES**

**APT30GS60B\_SRDQ2(G)**

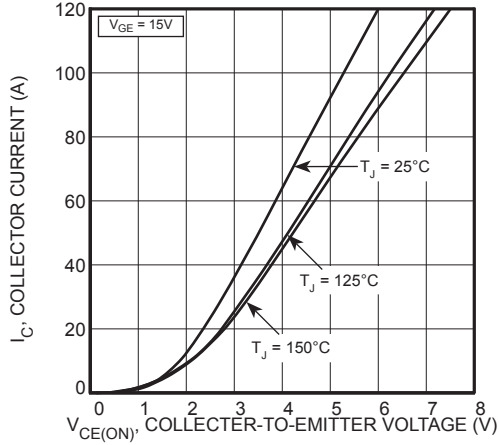

**FIGURE 1, Output Characteristics**

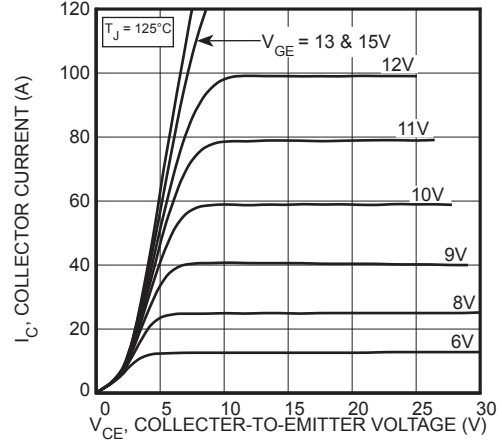

**FIGURE 2, Output Characteristics**

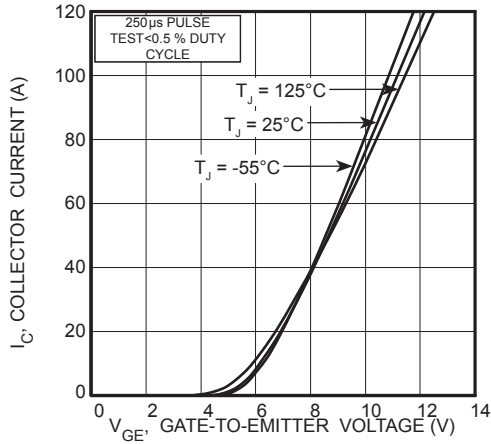

**FIGURE 3, Transfer Characteristics**

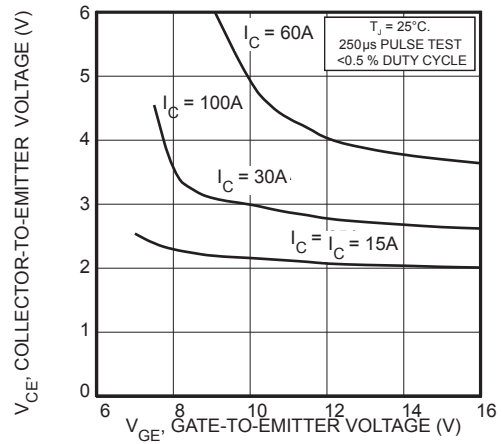

**FIGURE 4, On State Voltage vs Gate-to-Emitter Voltage**

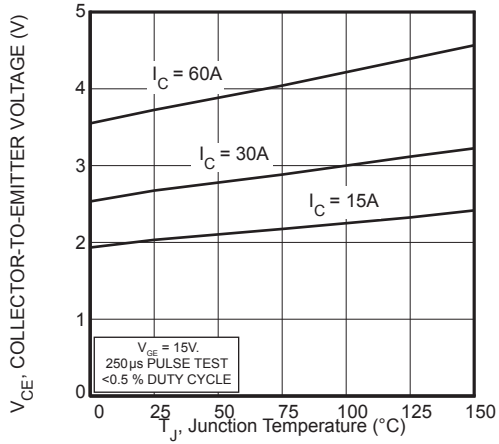

**FIGURE 5, On State Voltage vs Junction Temperature**

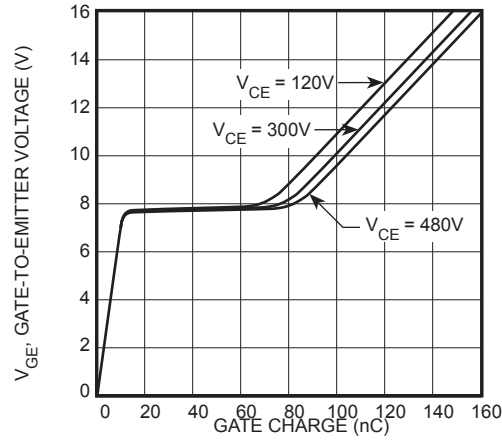

**FIGURE 6, Gate Charge**

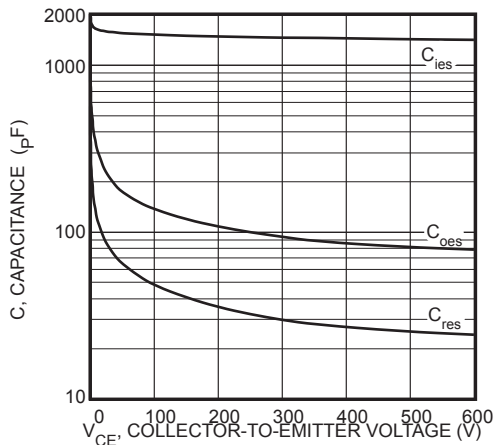

**FIGURE 7, Capacitance vs Collector-To-Emitter Voltage**

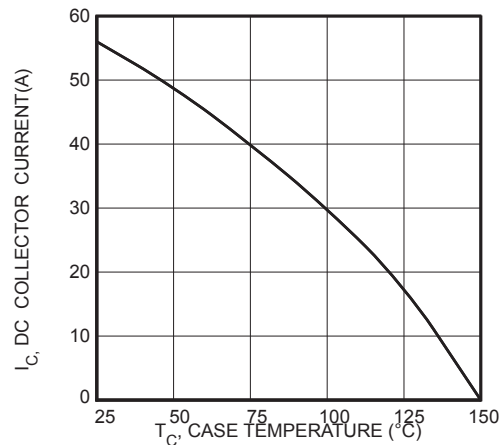

**FIGURE 8, DC Collector Current vs Case Temperature**

TYPICAL PERFORMANCE CURVES

APT30GS60B\_SRDQ2(G)

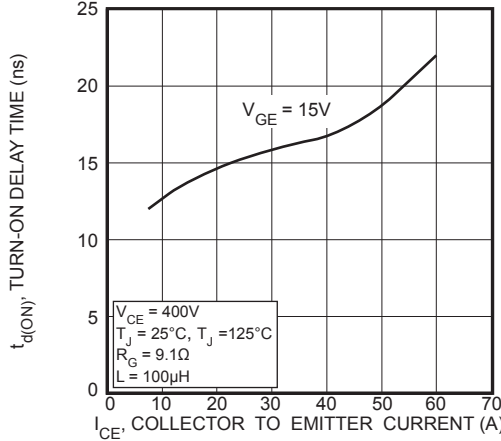

FIGURE 9, Turn-On Delay Time vs Collector Current

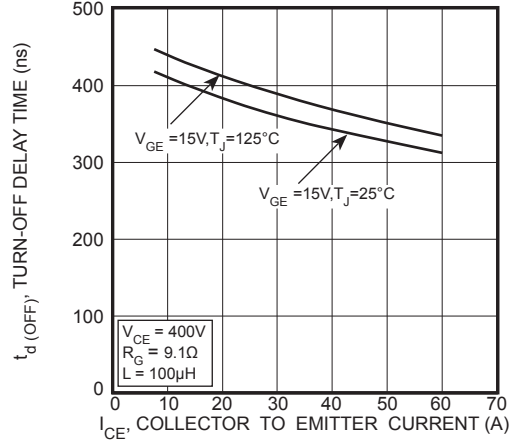

FIGURE 10, Turn-Off Delay Time vs Collector Current

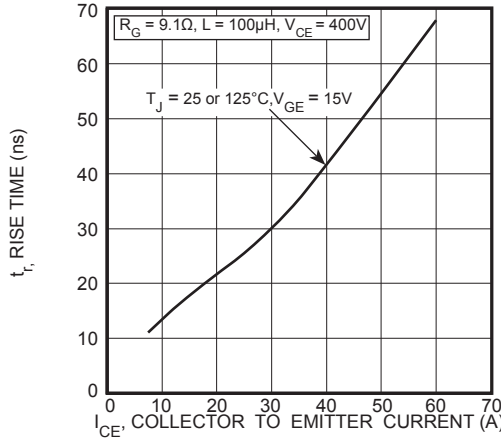

FIGURE 11, Current Rise Time vs Collector Current

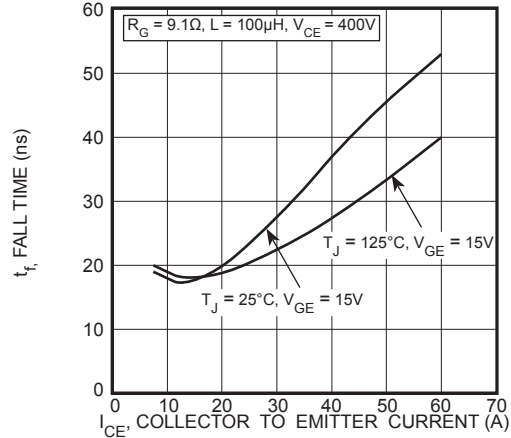

FIGURE 12, Current Fall Time vs Collector Current

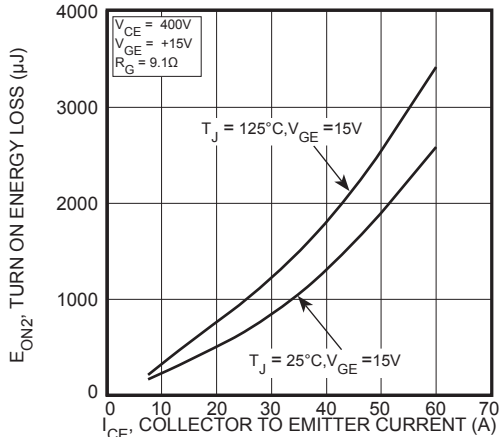

FIGURE 13, Turn-On Energy Loss vs Collector Current

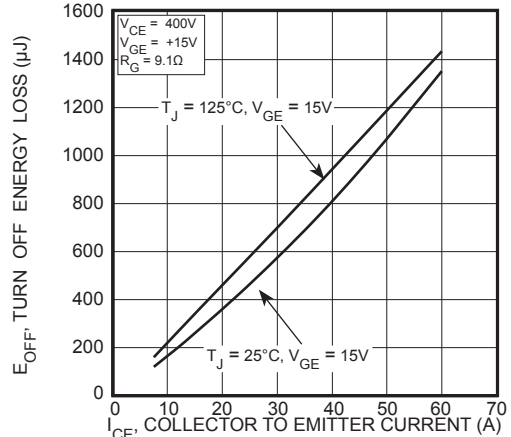

FIGURE 14, Turn Off Energy Loss vs Collector Current

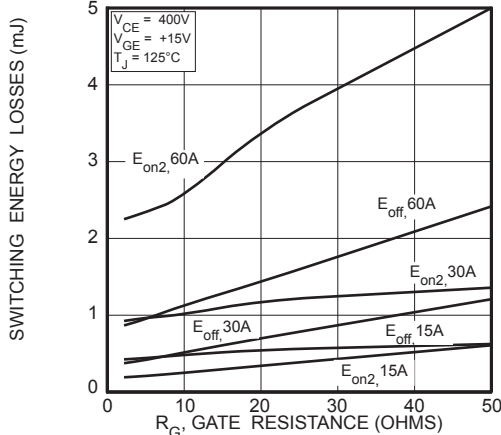

FIGURE 15, Switching Energy Losses vs. Gate Resistance

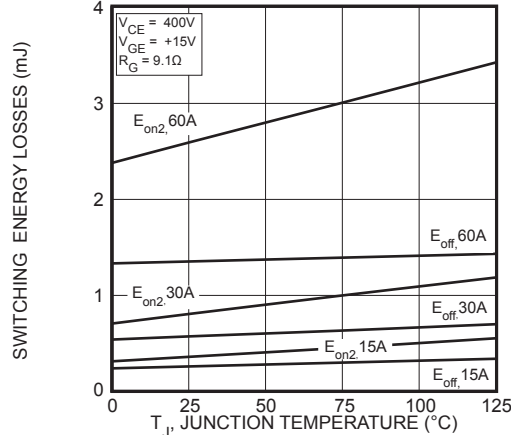
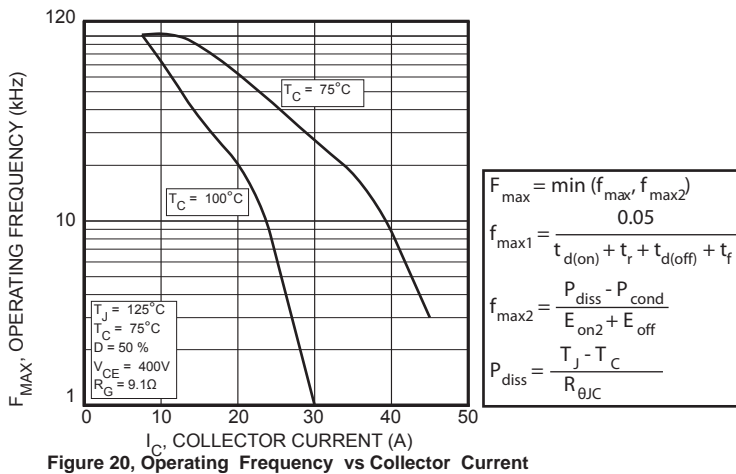
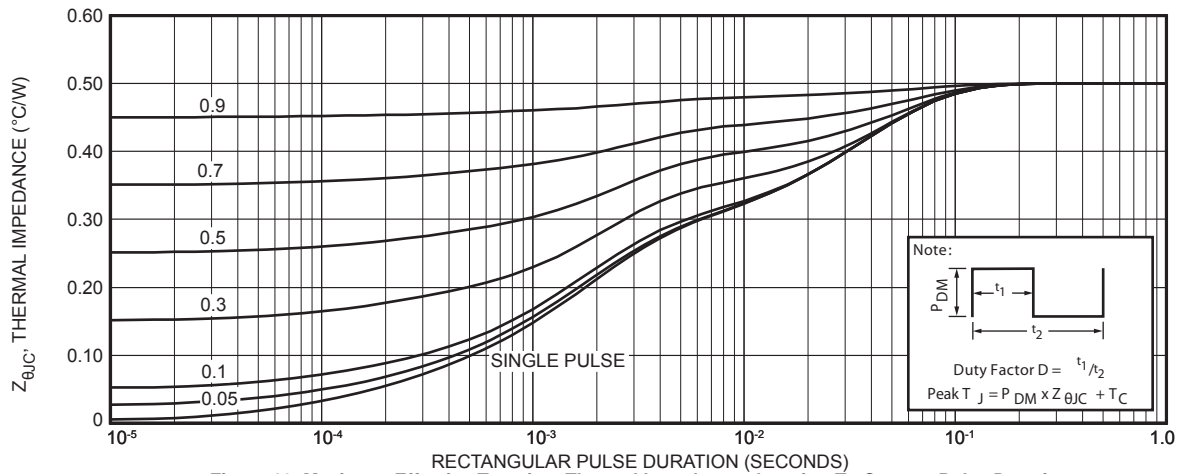
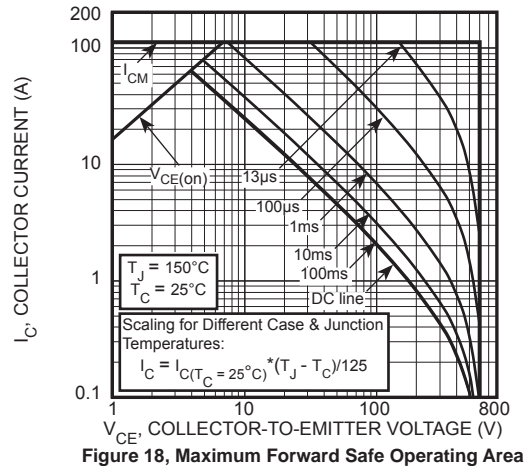
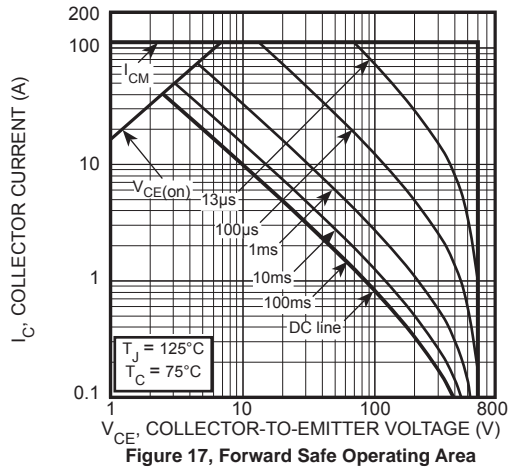

FIGURE 16, Switching Energy Losses vs Junction Temperature

TYPICAL PERFORMANCE CURVES

APT30GS60B\_SRDQ2(G)



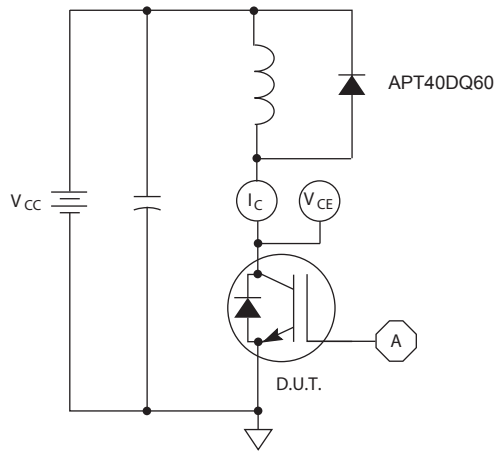

Figure 21, Inductive Switching Test Circuit

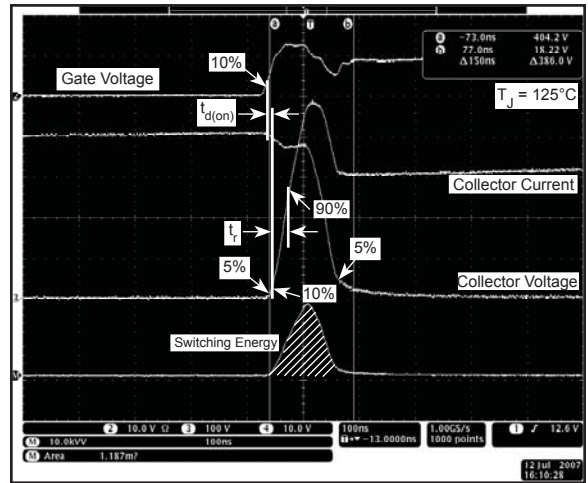

Figure 22, Turn-on Switching Waveforms and Definitions

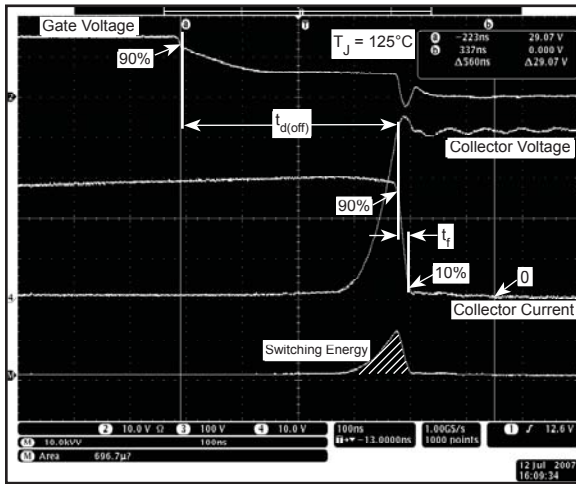

Figure 23, Turn-off Switching Waveforms and Definitions

FOOT NOTE:

- ① Repetitive Rating: Pulse width and case temperature limited by maximum junction temperature.
- ② Starting at  $T_J = 25^\circ\text{C}$ ,  $L = 224\mu\text{H}$ ,  $R_G = 25\Omega$ ,  $I_C = 30\text{A}$
- ③ Short circuit time:  $V_{GE} = 15\text{V}$ ,  $V_{CC} \leq 600\text{V}$ ,  $T_J \leq 150^\circ\text{C}$
- ④ Pulse test: Pulse width <  $380\mu\text{s}$ , duty cycle < 2%
- ⑤  $C_{o(cr)}$  is defined as a fixed capacitance with the same stored charge as  $C_{oes}$  with  $V_{CE} = 67\%$  of  $V_{(BR)CES}$ .
- ⑥  $C_{o(er)}$  is defined as a fixed capacitance with the same stored energy as  $C_{oes}$  with  $V_{CE} = 67\%$  of  $V_{(BR)CES}$ . To calculate  $C_{o(er)}$  for any value of  $V_{CE}$  less than  $V_{(BR)CES}$ , use this equation:  $C_{o(er)} = -1.40E-7/V_{DS}^2 + 1.47E-8/V_{DS} + 5.95E-11$ .
- ⑦  $R_G$  is external gate resistance, not including internal gate resistance or gate driver impedance (MIC4452).
- ⑧  $E_{on1}$  is the inductive turn-on energy of the IGBT only, without the effect of a commutating diode reverse recovery current adding to the IGBT turn-on switching loss. It is measured by clamping the inductance with a Silicon Carbide Schottky diode.
- ⑨  $E_{on2}$  is the inductive turn-on energy that includes a commutating diode reverse recovery current in the IGBT turn-on energy.
- ⑩  $E_{off}$  is the clamped inductive turn-off energy measured in accordance with JEDEC standard JESD24-1.

Microsemi reserves the right to change, without notice, the specifications and information contained herein.

# ULTRAFAST SOFT RECOVERY ANTI-PARALLEL DIODE

## MAXIMUM RATINGS

All Ratings:  $T_C = 25^\circ\text{C}$  unless otherwise specified.

Symbol	Characteristic / Test Conditions	APT30GS60B_SRDQ2(G)	Unit
$I_{F(AV)}$	Maximum Average Forward Current ( $T_C = 103^\circ\text{C}$ , Duty Cycle = 0.5)	30	Amps
$I_{F(RMS)}$	RMS Forward Current (Square wave, 50% duty)	43	
$I_{FSM}$	Non-Repetitive Forward Surge Current ( $T_J = 45^\circ\text{C}$ , 8.3 ms)	210	

## STATIC ELECTRICAL CHARACTERISTICS

Symbol	Characteristic / Test Conditions	Min	Type	Max	Unit
$V_F$	Forward Voltage		$I_F = 30\text{A}$	2.8	Volts
			$I_F = 60\text{A}$	3.4	
			$I_F = 30\text{A}, T_J = 125^\circ\text{C}$	2.1	

## DYNAMIC CHARACTERISTICS

Symbol	Characteristic	Test Conditions	Min	Typ	Max	Unit
$t_{rr}$	Reverse Recovery Time	$I_F = 1\text{A}, di_F/dt = -100\text{A}/\mu\text{s}, V_R = 30\text{V}, T_J = 25^\circ\text{C}$	-	26	-	ns
$t_{rr}$	Reverse Recovery Time	$I_F = 30\text{A}, di_F/dt = -200\text{A}/\mu\text{s}, V_R = 667\text{V}, T_C = 25^\circ\text{C}$	-	320	-	nAmps
$Q_{rr}$	Reverse Recovery Charge		-	545	-	
$I_{RRM}$	Maximum Reverse Recovery Current		-	4	-	Amps
$t_{rr}$	Reverse Recovery Time	$I_F = 30\text{A}, di_F/dt = -200\text{A}/\mu\text{s}, V_R = 667\text{V}, T_C = 125^\circ\text{C}$	-	435	-	ns
$Q_{rr}$	Reverse Recovery Charge		-	2100	-	nC
$I_{RRM}$	Maximum Reverse Recovery Current		-	9	-	Amps
$t_{rr}$	Reverse Recovery Time	$I_F = 30\text{A}, di_F/dt = -1000\text{A}/\mu\text{s}, V_R = 800\text{V}, T_C = 125^\circ\text{C}$	-	180	-	ns
$Q_{rr}$	Reverse Recovery Charge		-	2975	-	nC
$I_{RRM}$	Maximum Reverse Recovery Current		-	28	-	Amps

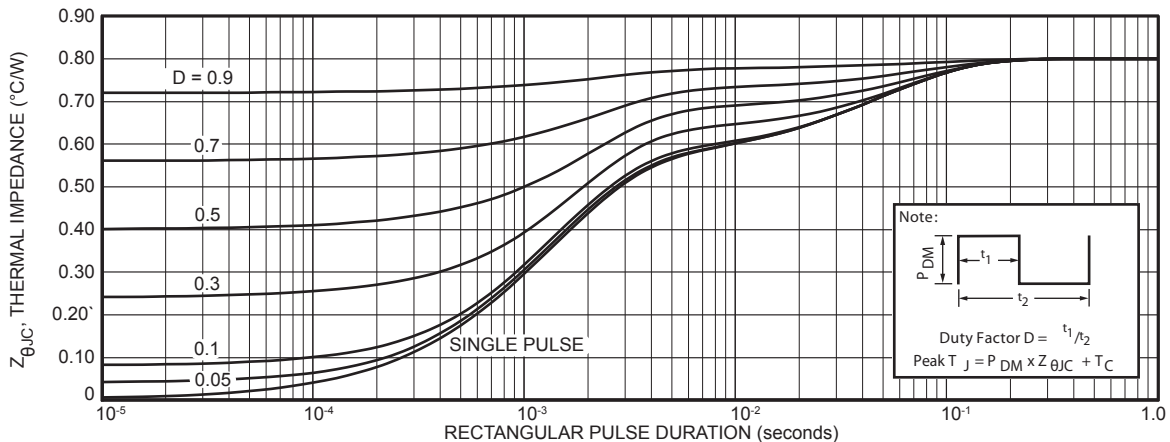

FIGURE 24. MAXIMUM EFFECTIVE TRANSIENT THERMAL IMPEDANCE, JUNCTION-TO-CASE vs. PULSE DURATION

# TYPICAL PERFORMANCE CURVES

APT30GS60B\_SRDQ2(G)

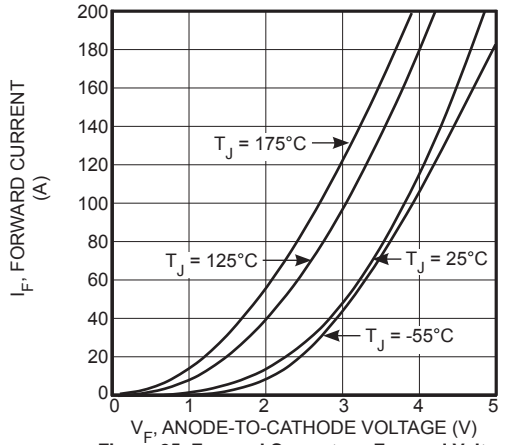

Figure 25. Forward Current vs. Forward Voltage

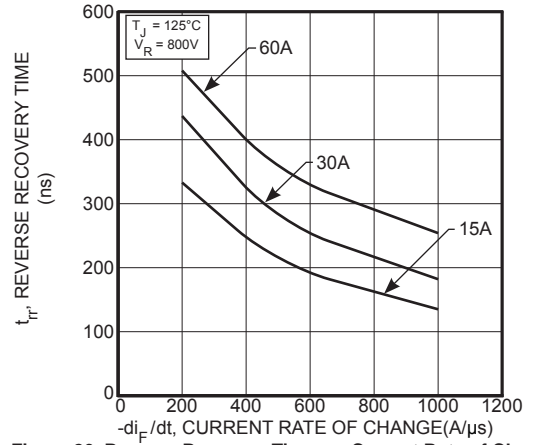

Figure 26. Reverse Recovery Time vs. Current Rate of Change

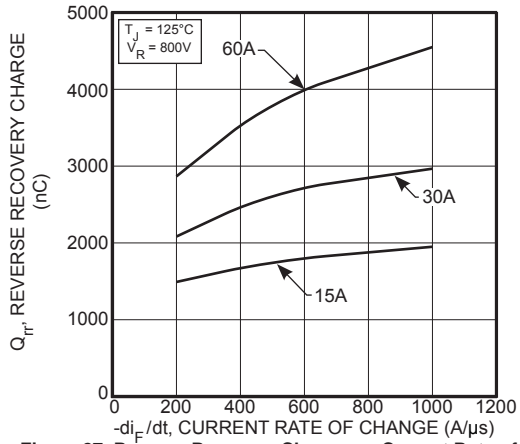

Figure 27. Reverse Recovery Charge vs. Current Rate of Change

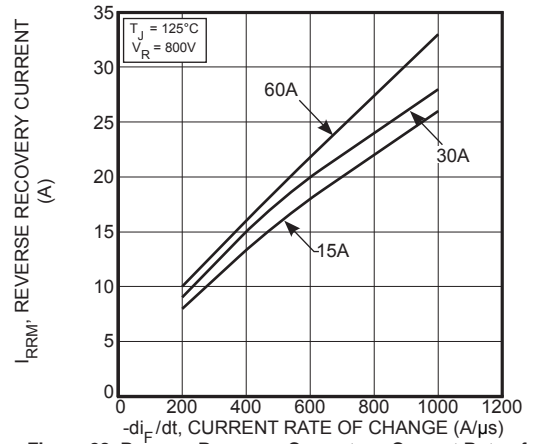

Figure 28. Reverse Recovery Current vs. Current Rate of Change

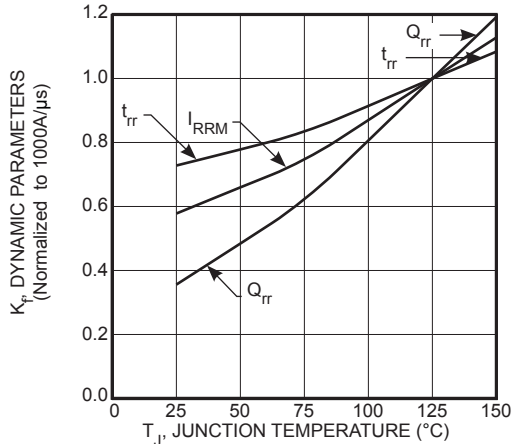

Figure 29. Dynamic Parameters vs. Junction Temperature

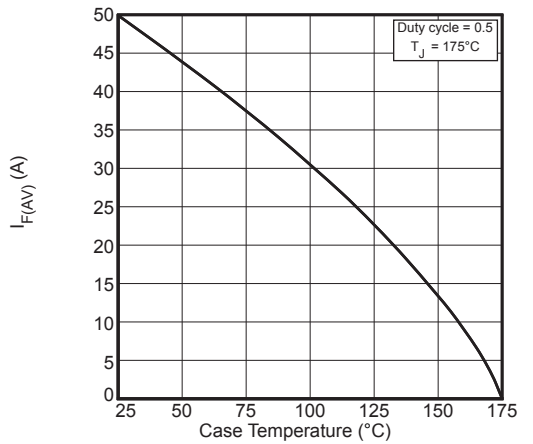

Figure 30. Maximum Average Forward Current vs. Case Temperature

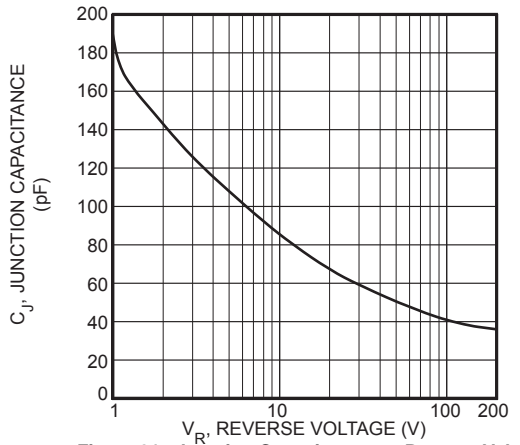

Figure 31. Junction Capacitance vs. Reverse Voltage