

High Performance Serial Persistent SRAM Memory

(AS1001204, AS1004204, AS1008204, AS1016204, AS3001204, AS3004204, AS3008204, AS3016204)

Features

- Interface
 - Serial Peripheral Interface QSPI (4-4-4)
 - Single Data Rate Mode: 108MHz
 - Double Data Rate Mode: 54MHz
- Technology
 - 40nm pMTJ STT-MRAM
 - Virtually unlimited Endurance and Data Retention (see Endurance and Data Retention specification on page 48)
- Density
 - 1Mb, 4Mb, 8Mb, 16Mb
- Operating Voltage Range
 - V_{CC}: 1.71V – 2.00V
 - V_{CC}: 2.70V – 3.60V
- Operating Temperature Range
 - Industrial: -40°C to 85°C
 - Industrial Plus: -40°C to 105°C
- Packages
 - 8-pad WSON (5.0mm x 6.0mm)
 - 8-pin SOIC (5.2mm x 5.2mm)
 - 24-ball FBGA (6.0mm x 8.0mm)
- Data Protection
 - Hardware Based
 - Write Protect Pin (WP#)
 - Software Based
 - Address Range Selectable through Configuration bits (Top/Bottom, Block Protect [2:0])
- Identification
 - 64-bit Unique ID
 - 64-bit User Programmable Serial Number
- Augmented Storage Array
 - 256-byte User Programmable with Write Protection
- Supports JEDEC Reset
- RoHS & REACH Compliant

Performance

Device Operation	Typical Values	Units
Frequency of Operation	108 (maximum)	MHz
Standby Current	160 (typical)	µA
Deep Power Down Current	5 (typical)	µA
Hibernate Current	0.1 (typical)	µA
Active Read Current – (4-4-4) SDR @ 108MHz	19 (typical)	mA
Active Write Current – (4-4-4) SDR @ 108MHz	38 (typical)	mA

Table of Contents

Features	1
Performance	1
Table of Contents	2
General Description	4
Ordering Options	5
Valid Combinations — Standard	5
Signal Description and Assignment	10
Package Options	12
8-Pad WSON (Top View)	12
8-Pin SOIC (Top View)	12
24-Ball FBGA (Top View)	12
Package Drawings	13
8-Pad WSON	13
8-Pin SOIC	14
24-Ball FBGA	15
Architecture	16
Device Initialization	19
Memory Map	21
Augmented Storage Array Map	21
Register Addresses	22
Register Map	23
Status Register / Device Protection Register (Read/Write)	23
Augmented Storage Array Protection Register (Read/Write)	24
Device Identification Register (Read Only)	25
Serial Number Register (Read/Write)	26
Unique Identification Register (Read Only)	26
Configuration Register 1 (Read/Write)	27
Configuration Register 2 (Read/Write)	27
Configuration Register 3 (Read/Write)	29

Configuration Register 4 (Read/Write).....	31
Instruction Set	32
Instruction Description and Structures	37
Electrical Specifications	48
CS# Operation & Timing	52
Data Output Operation & Timing	54
WP# Operation & Timing	55
Thermal Resistance	60
Product Use Limitations	61
Limited Warranty	Error! Bookmark not defined.
Revision History	62

General Description

ASxxxx204 is a magneto-resistive random-access memory (MRAM). It is offered in density ranging from 1Mbit to 16Mbit. MRAM technology is analogous to Flash technology with SRAM compatible read/write timings (Persistent SRAM, P-SRAM). Data is always non-volatile.

Figure 1: Technology Comparison

	SRAM	Flash	EEPROM	MRAM
Non-Volatility	–	√	√	√
Write Performance	√	–	–	√
Read Performance	√	–	–	√
Endurance	√	–	–	√
Power	–	–	–	√

MRAM is a true random-access memory; allowing both reads and writes to occur randomly in memory. MRAM is ideal for applications that must store and retrieve data without incurring large latency penalties. It offers low latency, low power, virtually infinite endurance and retention, and scalable non-volatile memory technology.

ASxxxx204 has a Serial Peripheral Interface (SPI). SPI is a synchronous interface which uses separate lines for data and clock to help keep the host and slave in perfect synchronization. The clock tells the receiver exactly when to sample the bits on the data line. This can be either the rising (low to high) or falling (high to low) or both edges of the clock signal; please consult the instruction sequences in this datasheet for more details. When the receiver detects that correct edge, it can latch in the data.

ASxxxx204 is available in small footprint 8-pad WSON, 8-pin SOIC and 24-Ball FBGA packages. These packages are compatible with similar low-power volatile and non-volatile products.

ASxxxx204 is offered with industrial (-40°C to 85°C) and industrial plus (-40°C to 105°C) operating temperature ranges.

Ordering Options

The ordering part numbers are formed by a valid combination of the following options:

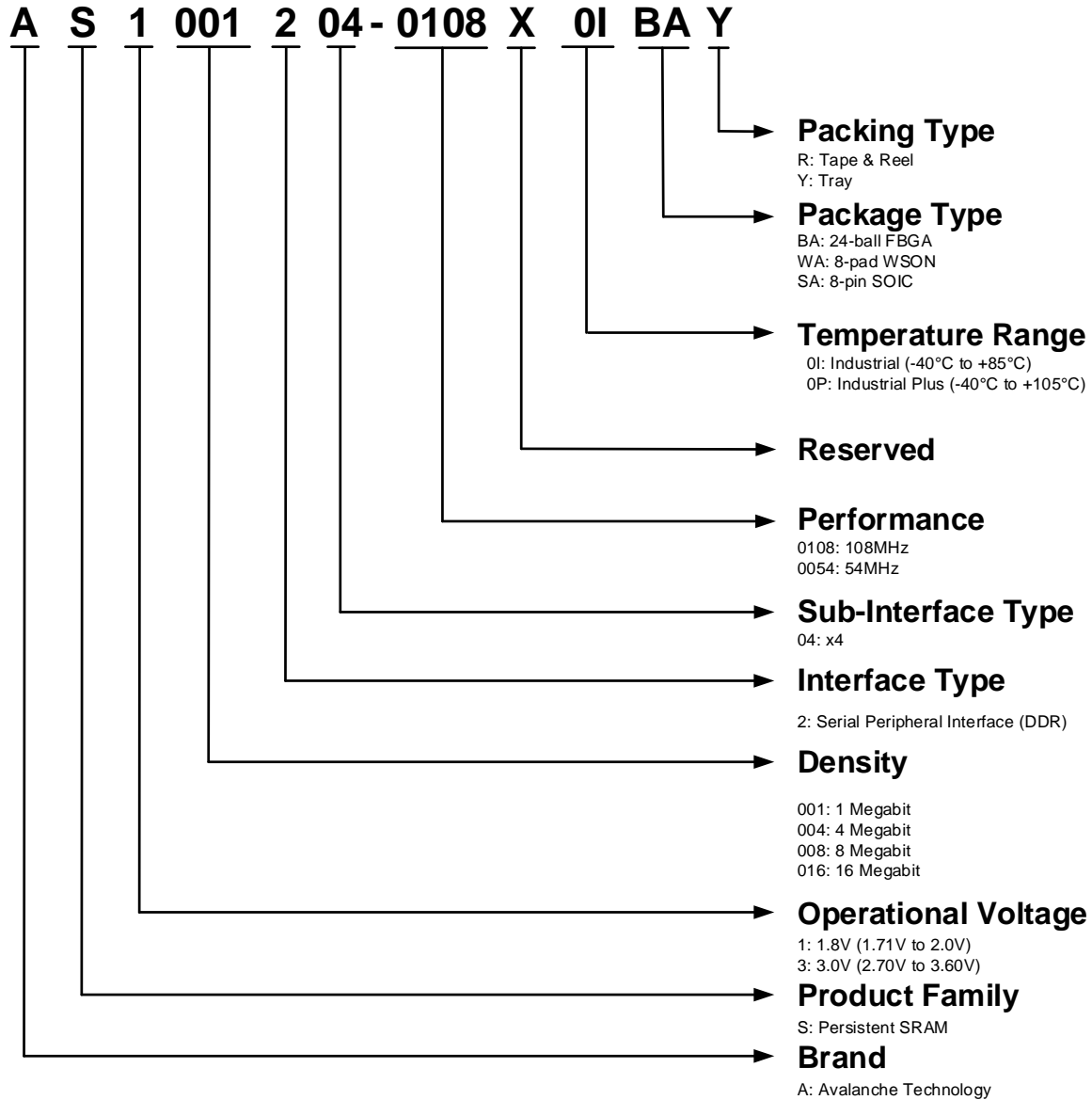

Valid Combinations — Standard

Valid Combinations list includes device configurations currently available. Contact your local sales office to confirm availability of specific valid combinations and to check on newly released combinations.

Table 1: Valid Combinations List

Valid Combinations – 108MHz				
Base Part Number	Temperature Range	Package Type	Packing Type	Part Number
AS1001204-0108X	0I, 0P	BA, WA, SA	R, Y	AS1001204-0108X0IBAR
				AS1001204-0108X0IBAY
				AS1001204-0108X0IWAR
				AS1001204-0108X0IWAY
				AS1001204-0108X0ISAR
				AS1001204-0108X0ISAY
				AS1001204-0108X0PBAR
				AS1001204-0108X0PBAY
				AS1001204-0108X0PWAR
				AS1001204-0108X0PWAY
				AS1001204-0108X0PSAR
				AS1001204-0108X0PSAY
				AS3001204-0108X
AS3001204-0108X0IBAY				
AS3001204-0108X0IWAR				
AS3001204-0108X0IWAY				
AS3001204-0108X0ISAR				
AS3001204-0108X0ISAY				
AS3001204-0108X0PBAR				
AS3001204-0108X0PBAY				
AS3001204-0108X0PWAR				
AS3001204-0108X0PWAY				
AS3001204-0108X0PSAR				
AS3001204-0108X0PSAY				
AS1004204-0108X	0I, 0P	BA, WA, SA	R, Y	
				AS1004204-0108X0IBAY
				AS1004204-0108X0IWAR
				AS1004204-0108X0IWAY
				AS1004204-0108X0ISAR
				AS1004204-0108X0ISAY
				AS1004204-0108X0PBAR
				AS1004204-0108X0PBAY
				AS1004204-0108X0PWAR
				AS1004204-0108X0PWAY
				AS1004204-0108X0PSAR
				AS1004204-0108X0PSAY
				AS3004204-0108X
AS3004204-0108X0IBAY				
AS3004204-0108X0IWAR				
AS3004204-0108X0IWAY				
AS3004204-0108X0ISAR				
AS3004204-0108X0ISAY				
AS3004204-0108X0PBAR				
AS3004204-0108X0PBAY				
AS3004204-0108X0PWAR				
AS3004204-0108X0PWAY				
AS3004204-0108X0PSAR				
AS3004204-0108X0PSAY				
AS1008204-0108X	0I, 0P	BA, WA, SA	R, Y	
				AS1008204-0108X0IBAY
				AS1008204-0108X0IWAR
				AS1008204-0108X0IWAY
				AS1008204-0108X0ISAR
				AS1008204-0108X0ISAY
				AS1008204-0108X0PBAR
				AS1008204-0108X0PBAY
				AS1008204-0108X0PWAR
				AS1008204-0108X0PWAY
				AS1008204-0108X0PSAR
				AS1008204-0108X0PSAY

1Mbit – 16Mbit SPI (4-4-4) P-SRAM Memory

Valid Combinations – 108MHz				
Base Part Number	Temperature Range	Package Type	Packing Type	Part Number
AS3008204-0108X	0I, 0P	BA, WA, SA	R, Y	AS3008204-0108X0IBAR
				AS3008204-0108X0IBAY
				AS3008204-0108X0IWAR
				AS3008204-0108X0IWAY
				AS3008204-0108X0ISAR
				AS3008204-0108X0ISAY
				AS3008204-0108X0PBAR
				AS3008204-0108X0PBAY
				AS3008204-0108X0PWAR
				AS3008204-0108X0PWAY
				AS3008204-0108X0PSAR
				AS3008204-0108X0PSAY
				AS1016204-0108X
AS1016204-0108X0IBAY				
AS1016204-0108X0IWAR				
AS1016204-0108X0IWAY				
AS1016204-0108X0ISAR				
AS1016204-0108X0ISAY				
AS1016204-0108X0PBAR				
AS1016204-0108X0PBAY				
AS1016204-0108X0PWAR				
AS1016204-0108X0PWAY				
AS1016204-0108X0PSAR				
AS1016204-0108X0PSAY				
AS3016204-0108X	0I, 0P	BA, WA, SA	R, Y	
				AS3016204-0108X0IBAY
				AS3016204-0108X0IWAR
				AS3016204-0108X0IWAY
				AS3016204-0108X0ISAR
				AS3016204-0108X0ISAY
				AS3016204-0108X0PBAR
				AS3016204-0108X0PBAY
				AS3016204-0108X0PWAR
				AS3016204-0108X0PWAY
				AS3016204-0108X0PSAR
				AS3016204-0108X0PSAY

Valid Combinations – 54MHz				
Base Part Number	Temperature Range	Package Type	Packing Type	Part Number
AS1001204-0054X	0I, 0P	BA, WA, SA	R, Y	AS1001204-0054X0IBAR
				AS1001204-0054X0IBAY
				AS1001204-0054X0IWAR
				AS1001204-0054X0IWAY
				AS1001204-0054X0ISAR
				AS1001204-0054X0ISAY
				AS1001204-0054X0PBAR
				AS1001204-0054X0PBAY
				AS1001204-0054X0PWAR
				AS1001204-0054X0PWAY
				AS1001204-0054X0PSAR
				AS1001204-0054X0PSAY
				AS3001204-0054X
AS3001204-0054X0IBAY				
AS3001204-0054X0IWAR				
AS3001204-0054X0IWAY				
AS3001204-0054X0ISAR				
AS3001204-0054X0ISAY				
AS3001204-0054X0PBAR				
AS3001204-0054X0PBAY				
AS3001204-0054X0PWAR				

1Mbit – 16Mbit SPI (4-4-4) P-SRAM Memory

Valid Combinations – 54MHz				
Base Part Number	Temperature Range	Package Type	Packing Type	Part Number
AS1004204-0054X	0I, 0P	BA, WA, SA	R, Y	AS3001204-0054X0PWAY
				AS3001204-0054X0PSAR
				AS3001204-0054X0PSAY
				AS1004204-0054X0IBAR
				AS1004204-0054X0IBAY
				AS1004204-0054X0IWAR
				AS1004204-0054X0IWAY
				AS1004204-0054X0ISAR
				AS1004204-0054X0ISAY
				AS1004204-0054X0PBAR
				AS1004204-0054X0PBAY
				AS1004204-0054X0PWAR
				AS1004204-0054X0PWAY
AS1004204-0054X0PSAR				
AS1004204-0054X0PSAY				
AS3004204-0054X	0I, 0P	BA, WA, SA	R, Y	AS3004204-0054X0IBAR
				AS3004204-0054X0IBAY
				AS3004204-0054X0IWAR
				AS3004204-0054X0IWAY
				AS3004204-0054X0ISAR
				AS3004204-0054X0ISAY
				AS3004204-0054X0PBAR
				AS3004204-0054X0PBAY
				AS3004204-0054X0PWAR
				AS3004204-0054X0PWAY
				AS3004204-0054X0PSAR
				AS3004204-0054X0PSAY
				AS1008204-0054X
AS1008204-0054X0IBAY				
AS1008204-0054X0IWAR				
AS1008204-0054X0IWAY				
AS1008204-0054X0ISAR				
AS1008204-0054X0ISAY				
AS1008204-0054X0PBAR				
AS1008204-0054X0PBAY				
AS1008204-0054X0PWAR				
AS1008204-0054X0PWAY				
AS1008204-0054X0PSAR				
AS1008204-0054X0PSAY				
AS3008204-0054X	0I, 0P	BA, WA, SA	R, Y	
				AS3008204-0054X0IBAY
				AS3008204-0054X0IWAR
				AS3008204-0054X0IWAY
				AS3008204-0054X0ISAR
				AS3008204-0054X0ISAY
				AS3008204-0054X0PBAR
				AS3008204-0054X0PBAY
				AS3008204-0054X0PWAR
				AS3008204-0054X0PWAY
				AS3008204-0054X0PSAR
				AS3008204-0054X0PSAY
				AS1016204-0054X
AS1016204-0054X0IBAY				
AS1016204-0054X0IWAR				
AS1016204-0054X0IWAY				
AS1016204-0054X0ISAR				
AS1016204-0054X0ISAY				
AS1016204-0054X0PBAR				
AS1016204-0054X0PBAY				
AS1016204-0054X0PWAR				
AS1016204-0054X0PWAY				
AS1016204-0054X0PSAR				
AS1016204-0054X0PSAY				



1Mbit – 16Mbit SPI (4-4-4) P-SRAM Memory

Valid Combinations – 54MHz				
Base Part Number	Temperature Range	Package Type	Packing Type	Part Number
AS3016204-0054X	0I, 0P	BA, WA, SA	R, Y	AS3016204-0054X0IBAR
				AS3016204-0054X0IBAY
				AS3016204-0054X0IWAR
				AS3016204-0054X0IWAY
				AS3016204-0054X0ISAR
				AS3016204-0054X0ISAY
				AS3016204-0054X0PBAR
				AS3016204-0054X0PBAY
				AS3016204-0054X0PWAR
				AS3016204-0054X0PWAY
				AS3016204-0054X0PSAR
				AS3016204-0054X0PSAY

Signal Description and Assignment

Figure 2: Device Pinout

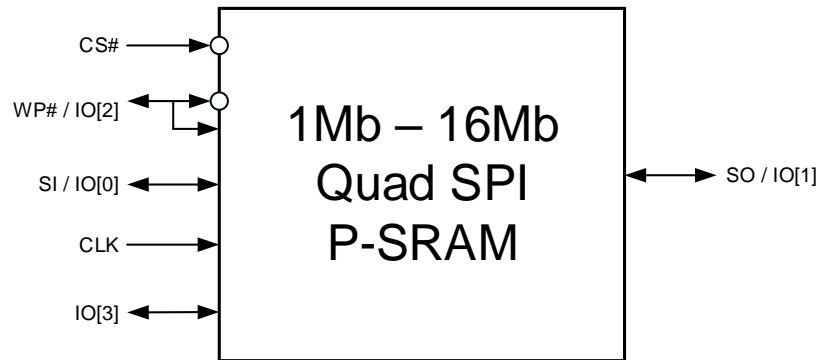

Table 2: Signal Description

Signal	Type	Description
CS#	Input	Chip Select: When CS# is driven High, the device will enter standby mode. All other input pins are ignored and the output pin is tri-stated. Driving CS# Low enables the device, placing it in the active mode. After power-up, a falling edge on CS# is required prior to the start of any instructions.
WP# / IO[2]	Input / Bidirectional	Write Protect (SPI): Write protects the status register in conjunction with the enable/disable bit of the status register. This is important since other write protection features are controlled through the Status Register. When the enable/disable bit of the status register is set to 1 and the WP# signal is driven Low, the status register becomes read-only and the WRITE STATUS REGISTER operation will not execute. This signal does not have internal pull-ups, it cannot be left floating and must be driven. WP# is valid only in Single SPI mode. Bidirectional Data 2 (DPI/QPI): The bidirectional I/O transfers data into and out of the device in Dual and Quad SPI modes.
CLK	Input	Clock: Provides the timing for the serial interface. Depending on the mode selected, either single (rising or falling) edge or both edges of the clock are utilized for information transfer. In Single Data Rate mode (SDR) command, address and data inputs are latched on the rising edge of the clock. Data is output on the falling edge of the clock. In Double Data Rate mode (DDR) command is latched on the rising edge of the clock. Address and Data inputs are latched on both edges of the clock. Similarly, Data is output on both edges of the clock. The following two SPI clock modes are supported. <ul style="list-style-type: none"> • SPI Mode 0 (CPOL = 0, CPHA = 0) – SDR and DDR • SPI Mode 3 (CPOL = 1, CPHA = 1) – SDR only
IO[3]	Bidirectional	Bidirectional Data 3 (DPI/QPI): The bidirectional I/O transfers data into and out of the device in Dual and Quad SPI modes.

Signal	Type	Description
SI / IO[0]	Input / Bidirectional	Serial Data Input (SPI): The unidirectional I/O transfers data into the device on the rising edge of the clock in Single SPI mode. Bidirectional Data 0 (DPI/QPI): The bidirectional I/O transfers data into and out of the device in Dual and Quad SPI modes.
SO / IO[1]	Output / Bidirectional	Serial Data Output (SPI): The unidirectional I/O transfers data out of the device on the falling edge of the clock in Single SPI mode. Bidirectional Data 1 (DPI/QPI): The bidirectional I/O that transfers data into and out of the device in Dual and Quad SPI modes.
V _{CC}	Supply	V_{CC}: Core and I/O power supply (WSON and SOIC packages). Core power supply (FBGA24 package). The valid options are 1.8v or 3.0v based on the product selected.
V _{CCIO}	Supply	V_{CCIO}: I/O power supply (FBGA24 package only). V _{CCIO} is allowed to vary from 1.8v to V _{CC}
V _{SS}	Supply	V_{SS}: Core and I/O ground supply.

Package Options

8-Pad WSON (Top View)

Figure 3: 8-Pad WSON

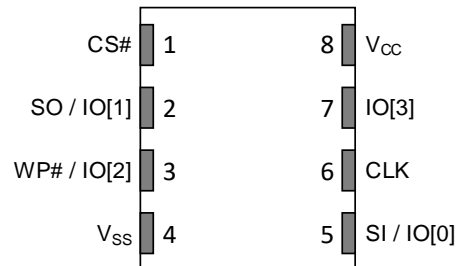

8-Pin SOIC (Top View)

Figure 4: 8-Pin SOIC



24-Ball FBGA (Top View)

Figure 5: 24-Ball FBGA

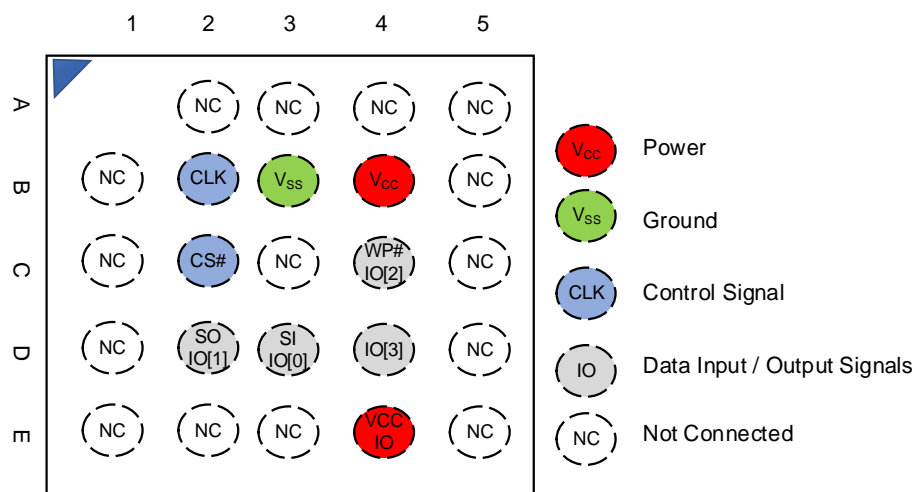

Package Drawings

8-Pad WSON

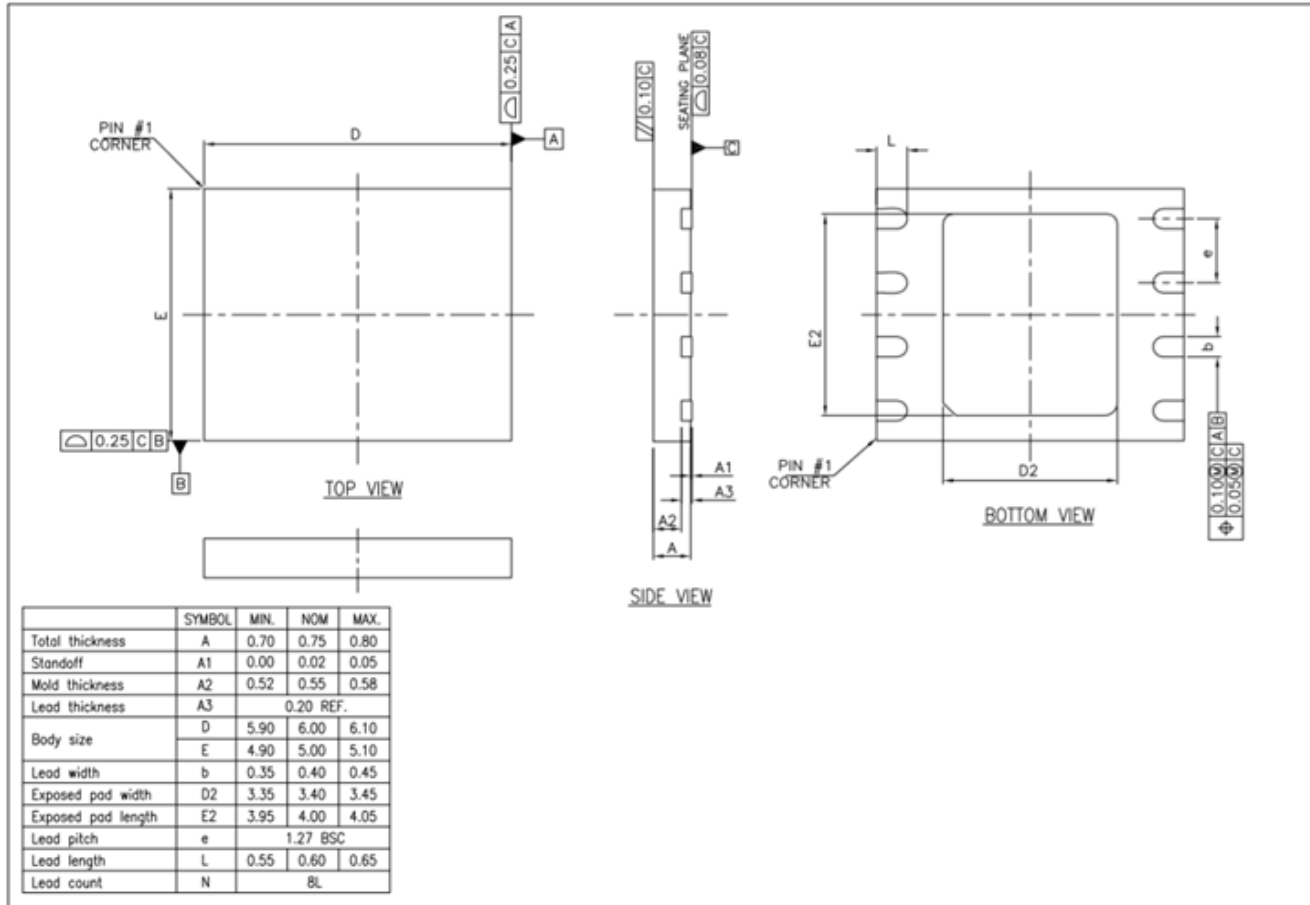

8-Pin SOIC

24-Ball FBGA

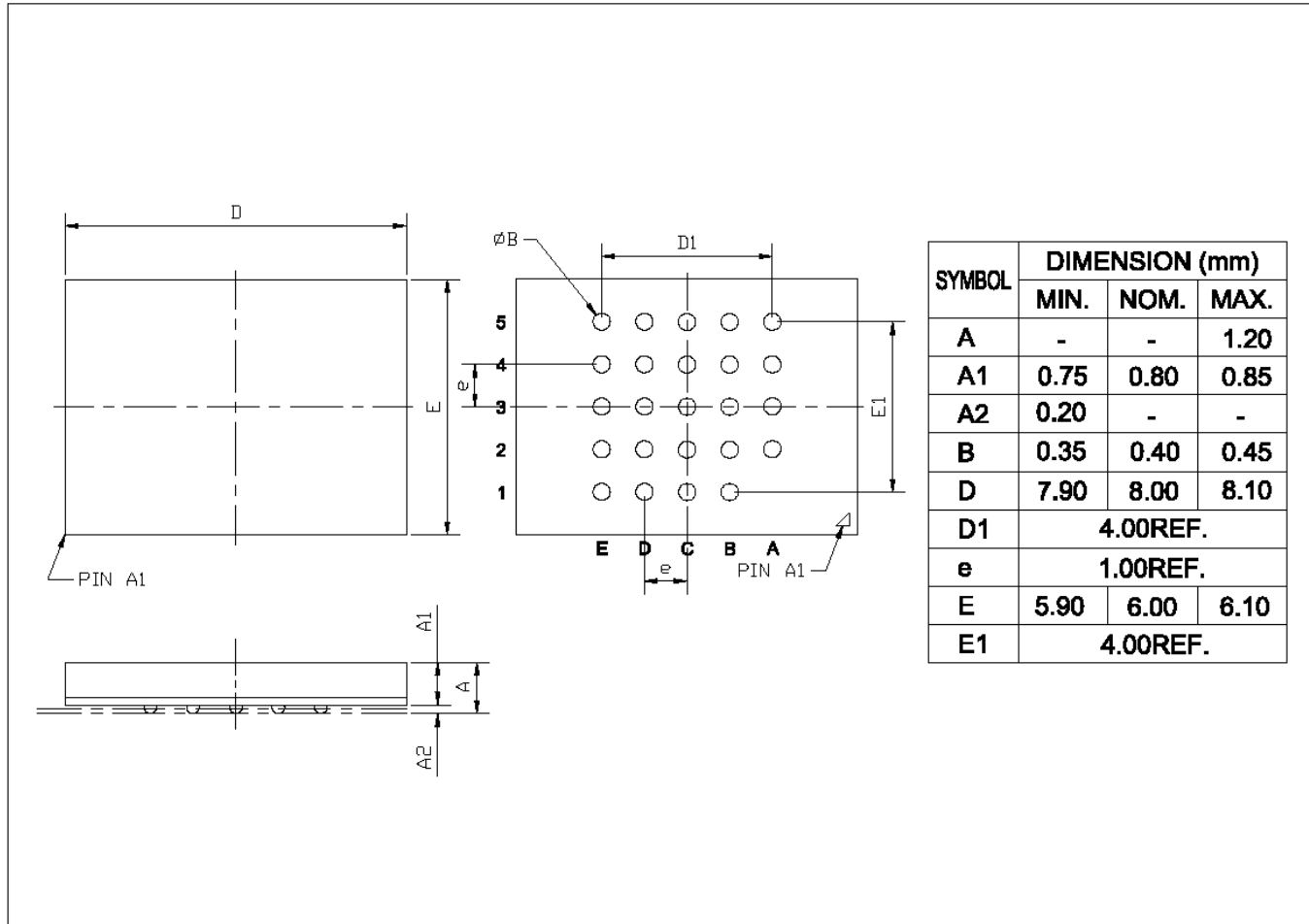

Architecture

ASxxxx204 is a high performance serial STT-MRAM device. It features a SPI-compatible bus interface running at 108MHz, eXecute-In-Place (XIP) functionality, and hardware/software based data protection mechanisms.

When CS# is Low, the device is selected and in active power mode. When CS# is High, the device is deselected but can remain in active power mode until ongoing internal operations are completed. Then the device goes into standby power mode and device current consumption drops to I_{SB}.













































ASxxxx204 contains an 8-bit instruction register. All functionality is controlled through the values loaded into this instruction register. In Single SPI mode, the device is accessed via the SI / IO[0] pin. In Dual and Quad SPI modes, IO[0:1] and IO[0:3] are used to access the device respectively. Furthermore, Single Data Rate (SDR) and Double Data Rate (DDR) instructions utilize CLK edges differently to transfer information; SDR uses a single CLK edge whereas DDR uses both edges of CLK. **Table 3** summarizes all the different interface modes supported and their respective I/O usage. **Table 4** shows the clock edge used for each instruction component.

Nomenclature adoption: A typical SPI instruction consists of command, address and data components. The bus width to transmit these three components varies based on the SPI interface mode selected. To accurately represent the number of I/Os used to transmit these three components, a nomenclature (command-address-data) is adopted and used throughout this document. Integers placed in the (command-address-data) fields represent the number of I/Os used to transmit the particular component. As an example, 1-1-1 means command, address and data are transmitted on a single I/O (SI / IO[0] or SO / IO[1]). On the other hand, 1-4-4 represents command being sent on a single I/O (SI / IO[0]) and address/data being sent on four I/Os (IO[3:0]).

Table 3: Interface Modes of Operations

Instruction Component	Single SPI (1-1-1)	Dual Input Output SPI (1-1-2)	Dual I/O SPI (1-2-2)	DPI (2-2-2)	Quad Input Output SPI (1-1-4)	Quad I/O SPI (1-4-4)	QPI (4-4-4)
Command	SI / IO[0]	SI / IO[0]	SI / IO[0]	IO[1:0]	SI / IO[0]	SI / IO[0]	IO[3:0]
Address	SI / IO[0]	SI / IO[0]	IO[1:0]	IO[1:0]	SI / IO[0]	IO[3:0]	IO[3:0]
Data Input	SI / IO[0]	IO[1:0]	IO[1:0]	IO[1:0]	IO[3:0]	IO[3:0]	IO[3:0]
Data Output	SO / IO[1]	IO[1:0]	IO[1:0]	IO[1:0]	IO[3:0]	IO[3:0]	IO[3:0]

Table 4: Clock Edge Used for instructions in SDR and DDR modes

Instruction Type	Command	Address	Data Input	Data Output
(1-1-1) SDR				 1
(1-1-1) DDR				 1
(1-1-2) SDR				 1
(1-2-2) SDR				 1
(2-2-2) SDR				 1
(2-2-2) DDR				 1
(1-1-4) SDR				 1
(1-4-4) SDR				 1
(1-4-4) DDR				 1
(4-4-4) SDR				 1
(4-4-4) DDR				 1

Notes:

R: Rising Clock Edge

F: Falling Clock Edge

1: Data output from ASxxxx204 always begins on the falling edge of the clock – SDR & DDR

ASxxxx204 supports eXecute-In-Place (XIP) which allows completing a series of read and write instructions without having to individually load the read or write command for each instruction. Thus, XIP mode saves command overhead and reduces random read & write access time. A special XIP byte must be entered after the address bits to enable/disable (Axh/Fxh) XIP.

ASxxxx204 offers both hardware and software based data protection schemes. Hardware protection is through WP# pin. Software protection is controlled by configuration bits in the Status register. Both schemes inhibit writing to the registers and memory array.

ASxxxx204 has a 256-byte Augmented Storage Array which is independent from the main memory array. It is user programmable and can be write protected against inadvertent writes.

Two lower power states are available in ASxxxx204, namely Deep Power Down and Hibernate. Data is not lost while the device is in either of these two low power states. Moreover, the device maintains all its configurations.

Figure 6: Functional Block Diagram



Table 5: Modes of Operation

Mode	Current	CS#	CLK	SI / IO[3:0]	SO / IO[3:0]
Standby	I _{SB}	H	Gated	Gated / Hi-Z	Hi-Z / Hi-Z
Active - Read	I _{READ}	L	Toggle	Command, Address	Data Output
Active - Write	I _{WRITE}	L	Toggle	Command, Address, Data Input	Hi-Z
Deep Power Down	I _{DPD}	H	Gated	Gated / Hi-Z	Hi-Z / Hi-Z
Hibernate	I _{HBN}	H	Gated	Gated / Hi-Z	Hi-Z / Hi-Z

Notes:

H: High (Logic '1')

L: Low (Logic '0')

Hi-Z: High Impedance

Device Initialization

When powering up, the following procedure is required to initialize the device correctly:

- Ramp up V_{CC} (R_{VR})
- CS# must follow V_{CC} during power-up (a 10K Ω pull-up Resistor to V_{CC} is recommended)
- It is recommended that no instructions are sent to the device when V_{CC} is below V_{CC} (minimum)
- During initial Power-up, recovering from power loss or brownout, a delay of t_{PU} is required before normal operation commences
- Upon Power-up, the device is in Standby mode

Figure 7: Power-Up Behavior



When powering down, the following procedure is required to turn off the device correctly:

- Ramp down V_{CC} (R_{VF})
- CS# must follow V_{CC} during power-down (a 10K Ω pull-up Resistor to V_{CC} is recommended)
- It is recommended that no instructions are sent to the device when V_{CC} is below V_{CC} (minimum)
- The Power-up timing needs to be observed after V_{CC} goes above V_{CC} (minimum)

Figure 8: Power-Down Behavior



Table 6: Power Up/Down Timing – 3.0V

Parameter	Symbol	Test Conditions	3.0V			Units
			Minimum	Typical	Maximum	
V_{CC} Range	V _{CC}	All operating voltages and temperatures	2.7	-	3.6	V
V_{CC} Ramp Up Time	R _{VR}		30	-	-	μs/V
V_{CC} Ramp Down Time	R _{VF}		20	-	-	μs/V
V_{CC} Power Up to First Instruction	t _{PU}		250	-	-	μs
V_{CC} Cutoff – Must Initialize Device	V _{CC-CUTOFF}		1.6	-	-	V
Time to Enter Deep Power Down	t _{EDPD}		-	-	3	μs
Time to Exit Deep Power Down	t _{EXDPD}		-	-	400	μs
Time to Enter Hibernate	t _{ENTHIB}		-	-	3	μs
Time to Exit Hibernate	t _{EXHIB}		-	-	450	μs
CS# Pulse Width	t _{CSDPD}		50	-	-	ns

Table 7: Power Up/Down Timing – 1.8V

Parameter	Symbol	Test Conditions	1.8V			Units
			Minimum	Typical	Maximum	
V_{CC} Range	V _{CC}	All operating voltages and temperatures	1.71	-	2.0	V
V_{CC} Ramp Up Time	R _{VR}		30	-	-	μs/V
V_{CC} Ramp Down Time	R _{VF}		20	-	-	μs/V
V_{CC} Power Up to First Instruction	t _{PU}		250	-	-	μs
V_{CC} Cutoff – Must Initialize Device	V _{CC-CUTOFF}		1.6	-	-	V
Time to Enter Deep Power Down	t _{EDPD}		-	-	3	μs
Time to Exit Deep Power Down	t _{EXDPD}		-	-	400	μs
Time to Enter Hibernate	t _{ENTHIB}		-	-	3	μs
Time to Exit Hibernate	t _{EXHIB}		-	-	450	μs
CS# Pulse Width	t _{CSDPD}		50	-	-	ns

Memory Map

Table 8: Memory Map

Density	Address Range	24-bit Address [23:0]	
1Mb	000000h – 01FFFFh	[23:17] – Logic '0'	[16:0] - Addressable
4Mb	000000h – 07FFFFh	[23:19] – Logic '0'	[18:0] - Addressable
8Mb	000000h – 0FFFFFFh	[23:20] – Logic '0'	[19:0] - Addressable
16Mb	000000h – 1FFFFFFh	[23:21] – Logic '0'	[20:0] - Addressable

Augmented Storage Array Map

Table 9: Augmented Storage Array Map

Density	Address Range	24-bit Address [23:0]	
1Mb	000000h – 0000FFh ¹	[23:8] – Logic '0'	[7:0] - Addressable
4Mb	000000h – 0000FFh ¹	[23:8] – Logic '0'	[7:0] - Addressable
8Mb	000000h – 0000FFh ¹	[23:8] – Logic '0'	[7:0] - Addressable
16Mb	000000h – 0000FFh ¹	[23:8] – Logic '0'	[7:0] - Addressable

Notes:

1: The 256-byte augmented storage array is divided into 8 individually readable and writeable sections (32 bytes per section). After an individual section is programmed, it can be write protected to prevent further programming.

Table 10: Individual Section Address Range

Section	Address Range	24-bit Address [23:0]	
0	000000h – 00001Fh	[23:8] – Logic '0'	[7:0] - Addressable
1	000020h – 00003Fh	[23:8] – Logic '0'	[7:0] - Addressable
2	000040h – 00005Fh	[23:8] – Logic '0'	[7:0] - Addressable
3	000060h – 00007Fh	[23:8] – Logic '0'	[7:0] - Addressable
4	000080h – 00009Fh	[23:8] – Logic '0'	[7:0] - Addressable
5	0000A0h – 0000BFh	[23:8] – Logic '0'	[7:0] - Addressable
6	0000C0h – 0000DFh	[23:8] – Logic '0'	[7:0] - Addressable
7	0000E0h – 0000FFh	[23:8] – Logic '0'	[7:0] - Addressable

Register Addresses

Table 11: Register Addresses

Register Name	Address
Status Register	0x000000h
Configuration Register 1	0x000002h
Configuration Register 2	0x000003h
Configuration Register 3	0x000004h
Configuration Register 4	0x000005h
Device Identification Register	0x000030h
Unique Identification Register	0x000040h

Notes:

1: Register address space is different from the memory array and augmented storage array.

2: The Status and Configuration registers need to be re-initialized after a solder reflow process. Refer to application note AN000008 for the detailed description.

Register Map

Status Register / Device Protection Register (Read/Write)

Status register is a legacy SPI register and contains options for enabling/disabling data protection.

Table 12: Status Register – Read and Write

Bits	Name	Description	Read / Write	Default State	Selection Options
SR[7]	WP#EN	Hardware Based WP# Protection Enable/Disable	R/W	0	1: Protection Enabled – write protects when WP# is Low 0: Protection Disabled – Doesn't write protect when WP# is Low
SR[6]	SNPEN	Serial Number Protection Enable/Disable	R/W	0	1: S/N Write protected - protection enabled 0: S/N Writable - protection disabled
SR[5]	TBSEL	Software Top/Bottom Memory Array Protection Selection	R/W	0	1: Bottom Protection Enabled (Lower Address Range) 0: Top Protection Enabled (Higher Address Range)
SR[4]	BPSEL[2]	Block Protect Selection Bit 2	R/W	0	Block Protection Bits (Table 13, Table 14)
SR[3]	BPSEL[1]	Block Protect Selection Bit 1	R/W	0	
SR[2]	BPSEL[0]	Block Protect Selection Bit 0	R/W	0	
SR[1]	WREN	Write Operation Protection Enable/Disable	R	0	1: Write Operation Protection Disabled 0: Write Operation Protection Enabled
SR[0]	RSVD	Reserved	R	0	Reserved for future use

Table 13: Top Block Protection Address Range Selection (TBSEL=0)

BPSEL [2]	BPSEL [1]	BPSEL [0]	Protected Portion	1Mb	4Mb	8Mb	16Mb
0	0	0	None	None	None	None	None
0	0	1	Upper 1/64	01F800h – 01FFFFh	07E000h – 07FFFFh	0FC000h – 0FFFFFh	1F8000h – 1FFFFFh
0	1	0	Upper 1/32	01F000h – 01FFFFh	07C000h – 07FFFFh	0F8000h – 0FFFFFh	1F0000h – 1FFFFFh
0	1	1	Upper 1/16	01E000h – 01FFFFh	078000h – 07FFFFh	0F0000h – 0FFFFFh	1E0000h – 1FFFFFh
1	0	0	Upper 1/8	01C000h – 01FFFFh	070000h – 07FFFFh	0E0000h – 0FFFFFh	1C0000h – 1FFFFFh
1	0	1	Upper 1/4	018000h – 01FFFFh	060000h – 07FFFFh	0C0000h – 0FFFFFh	180000h – 1FFFFFh
1	1	0	Upper 1/2	010000h – 01FFFFh	040000h – 07FFFFh	080000h – 0FFFFFh	1F0000h – 1FFFFFh
1	1	1	All	000000h – 01FFFFh	000000h – 07FFFFh	000000h – 0FFFFFh	000000h – 1FFFFFh

Table 14: Bottom Block Protection Address Range Selection (TBPSEL=1)

BPSEL [2]	BPSEL [1]	BPSEL [0]	Protected Portion	1Mb	4Mb	8Mb	16Mb
0	0	0	None	None	None	None	None
0	0	1	Lower 1/64	000000h – 0007FFh	000000h – 001FFFh	000000h – 003FFFh	000000h – 007FFFh
0	1	0	Lower 1/32	000000h – 00FFFFh	000000h – 003FFFh	000000h – 007FFFh	000000h – 00FFFFh
0	1	1	Lower 1/16	000000h – 001FFFh	000000h – 007FFFh	000000h – 00FFFFh	000000h – 01FFFFh
1	0	0	Lower 1/8	000000h – 003FFFh	000000h – 00FFFFh	000000h – 01FFFFh	000000h – 03FFFFh
1	0	1	Lower 1/4	000000h – 007FFFh	000000h – 01FFFFh	000000h – 03FFFFh	000000h – 07FFFFh
1	1	0	Lower 1/2	000000h – 00FFFFh	000000h – 03FFFFh	000000h – 07FFFFh	000000h – 0FFFFFFh
1	1	1	All	000000h – 01FFFFh	000000h – 07FFFFh	000000h – 0FFFFFFh	000000h – 1FFFFFFh

Table 15: Write Protection Modes

WREN (Status Register)	WP#EN (Status Register)	WP# (Pin)	Status & Configuration Registers	Memory ¹ Array Protected Area	Memory ¹ Array Unprotected Area
0	X	X	Protected	Protected	Protected
1	0	X	Unprotected	Protected	Unprotected
1	1	Low	Protected	Protected	Unprotected
1	1	High	Unprotected	Protected	Unprotected

Notes:

High: Logic '1'

Low: Logic '0'

X: Don't Care – Can be Logic '0' or '1'

Protected: Write protected

Unprotected: Writable

1: Memory address range protection based on Block Protection Bits

Augmented Storage Array Protection Register (Read/Write)

Augmented Storage Array Protection register contains options for enabling/disabling data protection for eight 32-byte sections.

Table 16: Augmented Storage Array Protection Register – Read and Write

Bits	Name	Description	Read / Write	Default State	Selection Options
ASP[7]	ASPS[7]	ASA Section 7 Write Protection Enable/Disable	R/W	0	1: Protection Enabled 0: Protection Disabled
ASP[6]	ASPS[6]	ASA Section 6 Write Protection Enable/Disable	R/W	0	1: Protection Enabled 0: Protection Disabled
ASP[5]	ASPS[5]	ASA Section 5 Write Protection Enable/Disable	R/W	0	1: Protection Enabled 0: Protection Disabled
ASP[4]	ASPS[4]	ASA Section 4 Write Protection Enable/Disable	R/W	0	1: Protection Enabled 0: Protection Disabled
ASP[3]	ASPS[3]	ASA Section 3 Write Protection Enable/Disable	R/W	0	1: Protection Enabled 0: Protection Disabled
ASP[2]	ASPS[2]	ASA Section 2 Write Protection Enable/Disable	R/W	0	1: Protection Enabled 0: Protection Disabled
ASP[1]	ASPS[1]	ASA Section 1 Write Protection Enable/Disable	R/W	0	1: Protection Enabled 0: Protection Disabled
ASP[0]	ASPS[0]	ASA Section 0 Write Protection Enable/Disable	R/W	0	1: Protection Enabled 0: Protection Disabled

Device Identification Register (Read Only)

Device identification register contains Avalanche's Manufacturing ID along with device configuration information.

Table 17: Device Identification Register – Read Only

Bits	Avalanche Manufacturer's ID	Device Configuration				
		Interface	Voltage	Temp	Density	Freq
ID[31:0]	ID[31:24]	ID[23:20]	ID[19:16]	ID[15:12]	ID[11:8]	ID[7:0]

Manufacturer ID	Interface	Voltage	Temperature	Density	Frequency
31-24	23-20	19-16	15-12	11-8	7-0
1110 0110	0000-HP QSPI	0001 - 3V	0000 - -40°C- 85°C	0001 - 1Mb	00000001 - 108MHz
		0010 - 1.8V	0001 - -40°C-105°C	0010 - 4Mb	00000010 – 54MHz
				0011 - 8Mb	00000011 - Reserved
				0100 - 16Mb	00000100 - Reserved
					00000101 - Reserved

Serial Number Register (Read/Write)

Serial Number register is user writable.

Table 18: Serial Number Register – Read and Write

Bits	Name	Description	Read / Write	Default State ¹	Selection Options
SN[63:0]	SN	Serial Number Value	R/W	000000000000 0000h	Value stored is based on the customer

Notes:

1: The default value is how the device is shipped from the factory.

Unique Identification Register (Read Only)

Unique Identification register contains a number unique to every device.

Table 19: Unique ID Register – Read Only

Bits	Name	Description	Read / Write	Selection Options
UID[63:0]	UID	Unique Identification Number Value	R	Value stored is written in the factory and is device specific

Configuration Register 1 (Read/Write)

Configuration Register 1 controls locking/unlocking data protection options set in the Status register. Once locked, the protection options cannot be changed in the Status register.

Table 20: Configuration Register 1 – Read and Write

Bits	Name	Description	Read / Write	Default State	Selection Options
CR1[7]	RSVD	Reserved	R	0	Reserved for future use
CR1[6]	RSVD	Reserved	R	0	Reserved for future use
CR1[5]	RSVD	Reserved	R	0	Reserved for future use
CR1[4]	RSVD	Reserved	R	0	Reserved for future use
CR1[3]	RSVD	Reserved	R	0	Reserved for future use
CR1[2]	MAPLK	Status Register Lock Enable/Disable (TBSEL, BPSEL[2:0])	R/W	0	1: Lock TBSEL and BPSEL[2:0] 0: Unlock TBSEL and BPSEL[2:0]
CR1[1]	RSVD	Reserved	R	0	Reserved for future use
CR1[0]	ASPLK	Augmented Storage Array Data Protection	R/W	0	1: Write Protect Augmented Storage Array 0: Not Write Protect Augmented Storage Array

Configuration Register 2 (Read/Write)

Configuration Register 2 controls the interface type along with memory array access latency.

Table 21: Configuration Register 2 – Read and Write

Bits	Name	Description	Read / Write	Default State	Selection Options
CR2[7]	RSVD	Reserved	R	0	Reserved for future use
CR2[6]	QPISL	Quad SPI (QPI 4-4-4) Interface Mode Enable/Disable	R ²	0	1: Quad SPI (QPI 4-4-4) Enabled 0: Single SPI (SPI 1-1-1) Enabled
CR2[5]	RSVD	Reserved	R	0	Reserved for future use
CR2[4]	DPISL	Dual SPI (DPI 2-2-2) Interface Mode Enable/Disable	R ²	0	1: Dual SPI (DPI 2-2-2) Enabled

Bits	Name	Description	Read / Write	Default State	Selection Options
					0: Single SPI (SPI 1-1-1) Enabled
CR2[3]	MLATS[3]	Memory Array Read Latency Selection ¹	R/W	0	0000: 0 Cycles - Default 0001: 1 Cycle
CR2[2]	MLATS[2]			0	0010: 2 Cycles 0011: 3 Cycles
CR2[1]	MLATS[1]			0	0100: 4 Cycles 0101: 5 Cycles 0110: 6 Cycles 0111: 7 Cycles
CR2[0]	MLATS[0]			0	1000: 8 Cycles 1001: 9 Cycle 1010: 10 Cycles 1011: 11 Cycles 1100: 12 Cycles 1101: 13 Cycles 1110: 14 Cycles 1111: 15 Cycles

Notes:

 1: Latency is frequency dependent. Please consult **Table 22** and **Table 23**.

2: These interface options can only be set through instructions.

Table 22: Memory Array Read Latency Cycles vs. Maximum Clock Frequency (with XIP)

Read Type	Latency	Max Frequency			
		ASxxxx2x108xx	ASxxxx2x054xx	ASxxxx2x040xx	ASxxxx2x027xx
(1-1-1) SDR	8-15	108MHz	54MHz	40MHz	27MHz
(1-1-1) DDR		54MHz	27MHz	20MHz	13MHz
(1-1-2) SDR		108MHz	54MHz	40MHz	27MHz
(1-2-2) SDR		108MHz	54MHz	40MHz	27MHz
(2-2-2) SDR		108MHz	54MHz	40MHz	27MHz
(2-2-2) DDR		54MHz	27MHz	20MHz	13MHz
(1-1-4) SDR	12-15	108MHz	54MHz	40MHz	27MHz
(1-4-4) SDR		108MHz	54MHz	40MHz	27MHz
(1-4-4) DDR		54MHz	27MHz	20MHz	13MHz
(4-4-4) SDR		108MHz			
(4-4-4) DDR		54MHz	54MHz	40MHz	27MHz
		54MHz	27MHz	20MHz	13MHz

Table 23: Memory Read Latency Cycles vs. Maximum Clock Frequency (without XIP)

Read Type	Latency	Max Frequency			
		ASxxxx2x108xx	ASxxxx2x054xx	ASxxxx2x040xx	ASxxxx2x027xx
(1-1-1) SDR	0	50MHz	40MHz	40MHz	27MHz

Table 24: Augmented Storage Array Read Latency Cycles vs. Maximum Clock Frequency

Read Type	Latency	Max Frequency			
		ASxxxx2x108xx	ASxxxx2x054xx	ASxxxx2x040xx	ASxxxx2x027xx
(1-1-1) SDR	8-15	50MHz	40MHz	40MHz	27MHz

Table 25: Read Any Register Command Latency Cycles vs. Maximum Clock Frequency

Read Type	Max Frequency	Latency Cycles
(1-1-1) SDR	108MHz	8
(2-2-2) SDR	108MHz	4
(4-4-4) SDR	108MHz	2

Configuration Register 3 (Read/Write)

Configuration Register 3 controls the output driver strength along with read data wrap selection.

Table 26: Configuration Register 3 – Read and Write

Bits	Name	Description	Read / Write	Default		Selection Options
				1.8V	3.0V	
CR3[7]	ODSEL[2]	Output Driver Strength Selector	R/W	0	0	1.8V 3.0V 000: 45Ω ¹ 35Ω
CR3[6]	ODSEL[1]			0	1	001: 120Ω 75Ω
CR3[5]	ODSEL[0]			0	1	010: 90Ω 60Ω
						011: 70Ω 45Ω ¹
						100: 45Ω 35Ω
						101: 60Ω 40Ω
						110: 30Ω 20Ω
						111: 20Ω 15Ω
CR3[4]	WRAPS	Read WRAP Enable / Disable (16/32/64/128/256 Byte)	R/W	0		1: Read Data Wrap Enabled 0: Read Data Wrap Disabled
CR3[3]	RSVD	Reserved	R	0		Reserved for future use
CR3[2]	WRPLS[2]	Wrap Length Selector ²	R/W	0		000: 16-byte Boundary
CR3[1]	WRPLS[1]			0		001: 32-byte Boundary
CR3[0]	WRPLS[0]			0		010: 64-byte Boundary
						011: 128-byte Boundary
						100: 256-byte Boundary
						101: Reserved
						110: Reserved
						111: Reserved

Notes:

 1: Default Setting (V_{CC} dependent).

2: If Wrap is enabled, the read data wraps within an aligned 16/32/64/128/256-byte boundary at any address. The starting address entered selects the group of bytes and the first data returned is the addressed byte. Bytes are then read sequentially until the end of the group boundary is reached. If read continues, the address wraps to the beginning of the group and continues to read sequentially.

Configuration Register 4 (Read/Write)

Configuration Register 4 controls Write Enable protection (WREN – Status Register) reset functionality during memory array writing¹. This functionality makes SPI MRAM compatible to other SPI devices.

Table 27: Configuration Register 4 – Read and Write

Bits	Name	Description	Read / Write	Default State	Selection Options
CR4[7]	RSVD	Reserved	R/W	0	Reserved for future use
CR4[6]	RSVD	Reserved		0	Reserved for future use
CR4[5]	RSVD	Reserved		0	Reserved for future use
CR4[4]	RSVD	Reserved		0	Reserved for future use
CR4[3]	RSVD	Reserved		0	Reserved for future use
CR4[2]	RSVD	Reserved		1	Reserved ²
CR4[1]	WRENS[1]	WREN Reset Selector		0	00: Normal: WREN is prerequisite to all Memory Array Write instruction. (WREN is reset after CS# goes High) 01: SRAM: WREN is not a prerequisite to Memory Array Write instruction (WREN is ignored)
CR4[0]	WRENS[0]	(Memory & Augmented Storage Array Write Functionality)		1	10: Back-to-Back: WREN is prerequisite to only the first Memory Array Write instruction. WREN disable instruction must be executed to reset WREN. (WREN does not reset once CS# goes High) 11: Illegal - Reserved for future use

Notes:

1: Write Enable protection (WREN – Status Register) for Registers is maintained irrespective of the Configuration Register 4 settings. In other words, all register write instructions require WREN to be set and WREN resets once CS# goes High for the write instruction.

2: Must be set to “1”. Writing a “0” to this bit may impact device functionality.

Instruction Set

Table 28: Instruction Set

#	Instruction Name	Command (Opcode)	(1-0-0)	(1-0-1)	(1-1-1)	(1-1-2)	(1-2-2)	(2-0-0)	(2-0-2)	(2-2-2)	(1-1-4)	(1-4-4)	(4-0-0)	(4-0-4)	(4-4-4)	XIP	SDR	DDR	Latency Cycles	Data Bytes	Max. Frequency	Prerequisite
Control Instructions																						
1	No Operation	NOOP 00h	•					•					•				•				108 MHz	
2	Write Enable	WREN 06h	•					•					•				•				108 MHz	
3	Write Disable	WRDI 04h	•					•					•				•				108 MHz	
4	Enable DPI	DPIE 37h	•										•				•				108 MHz	
5	Enable QPI	QPIE 38h	•					•									•				108 MHz	
6	Enable SPI	SPIE FFh						•					•				•				108 MHz	
7	Enter Deep Power Down	DPDE B9h	•					•					•				•				108 MHz	
8	Enter Hibernate	HBNE BAh	•					•					•				•				108 MHz	
9	Software Reset Enable	SRTE 66h	•					•					•				•				108 MHz	
10	Software Reset	SRST 99h	•					•					•				•				108 MHz	SRTE
11	Exit Deep Power Down	DPDX ABh	•					•					•				•				108 ⁷ MHz	
Read Register Instructions																						

1Mbit – 16Mbit SPI (4-4-4) P-SRAM Memory

#	Instruction Name	Command (Opcode)	(1-0-0)	(1-0-1)	(1-1-1)	(1-1-2)	(1-2-2)	(2-0-0)	(2-0-2)	(2-2-2)	(1-1-4)	(1-4-4)	(4-0-0)	(4-0-4)	(4-4-4)	XIP	SDR	DDR	Latency Cycles	Data Bytes	Max. Frequency	Prerequisite
12	Read Status Register	RDSR 05h	•						•					•			•			1	54 MHz	
13	Read Configuration Register 1	RDC1 35h	•						•					•			•			1	54 MHz	
14	Read Configuration Register 2	RDC2 3Fh	•						•					•			•			1	54 MHz	
15	Read Configuration Register 3	RDC3 44h	•						•					•			•			1	54 MHz	
16	Read Configuration Register 4	RDC4 45h	•						•					•			•			1	54 MHz	
17	Read Configuration Register 1, 2, 3, 4	RDCX 46h	•						•					•			•			4	54 MHz	
18	Read Device ID	RDID 9Fh	•						•					•			•			4	54 MHz	
19	Read Unique ID	RUID 4Ch	•						•					•			•			8	54 MHz	
20	Read Serial Number Register	RDSN C3h	•						•					•			•			8	54 MHz	
21	Read Augmented Array Protection Register	RDAP 14h	•						•					•			•			1	54 MHz	
22	Read Any Register - Address Based	RDAR 65h		•						•					•		•		•	1 to 8	108 MHz	
Write Register Instructions																						
23	Write Status Register	WRSR 01h		•					•					•			•			1	108 MHz	WREN
24	Write Configuration Registers 1, 2, 3, 4	WRCX 87h		•					•					•			•			4	108 MHz	WREN



1Mbit – 16Mbit SPI (4-4-4) P-SRAM Memory

#	Instruction Name	Command (Opcode)	(1-0-0)	(1-0-1)	(1-1-1)	(1-1-2)	(1-2-2)	(2-0-0)	(2-0-2)	(2-2-2)	(1-1-4)	(1-4-4)	(4-0-0)	(4-0-4)	(4-4-4)	XIP	SDR	DDR	Latency Cycles	Data Bytes	Max. Frequency	Prerequisite
25	Write Serial Number Register	WRSN C2h	•						•					•			•			8	108 MHz	WREN
26	Write Augmented Array Protection Register	WRAP 1Ah	•						•					•			•			1	108 MHz	WREN
27	Write Any Register - Address Based	WRAR 71h			•					•					•		•			1 to 8	108 MHz	WREN
Read Memory Array Instructions																						
28	Read Memory Array - SDR	READ 03h			•												•			1 to ∞	50 MHz	
29	Fast Read Memory Array - SDR	RDFR 0Bh			•					•					•	•	•		•	1 to ∞	108 MHz	
30	Fast Read Memory Array - DDR	DRFR 0Dh			•					•					•	•		•	•	1 to ∞	54 MHz	
31	Read Dual Output Memory Array - SDR	RDDO 3Bh				•										•	•		•	1 to ∞	108 MHz	
32	Read Quad Output Memory Array - SDR	RDQO 6Bh									•					•	•		•	1 to ∞	108 MHz	
33	Read Dual I/O Memory Read - SDR	RDDI BBh					•									•	•		•	1 to ∞	108 MHz	
34	Read Dual I/O Memory Read - DDR	DRDI BDh					•									•		•	•	1 to ∞	54 MHz	
35	Read Quad I/O Memory Read - SDR	RDQI EBh										•				•	•		•	1 to ∞	108 MHz	
36	Read Quad I/O Memory Read - DDR	DRQI EDh										•				•		•	•	1 to ∞	54 MHz	
Write Memory Array Instructions																						

1Mbit – 16Mbit SPI (4-4-4) P-SRAM Memory

#	Instruction Name	Command (Opcode)	(1-0-0)	(1-0-1)	(1-1-1)	(1-1-2)	(1-2-2)	(2-0-0)	(2-0-2)	(2-2-2)	(1-1-4)	(1-4-4)	(4-0-0)	(4-0-4)	(4-4-4)	XIP	SDR	DDR	Latency Cycles	Data Bytes	Max. Frequency	Prerequisite
37	Write Memory Array - SDR	WRTE 02h			•												•			1 to ∞	108 MHz	WREN
38	Fast Write Memory Array - SDR	WRFT DAh			•					•					•	•	•			1 to ∞	108 MHz	WREN
39	Fast Write Memory Array - DDR	DRFW DEh			•					•					•	•		•		1 to ∞	54 MHz	WREN
40	Write Dual Input Memory Array - SDR	WDUI A2h				•										•	•			1 to ∞	108 MHz	WREN
41	Write Quad Input Memory Array - SDR	WQDI 32h									•					•	•			1 to ∞	108 MHz	WREN
42	Write Quad Input Memory Array - DDR	DWQI 31h									•					•		•		1 to ∞	54 MHz	WREN
43	Write Dual I/O Memory Array - SDR	WDIO A1h					•									•	•			1 to ∞	108 MHz	WREN
44	Write Quad I/O Memory Array - SDR	WQIO D2h									•					•	•			1 to ∞	108 MHz	WREN
45	Write Quad I/O Memory Array - DDR	DWQ O D1h									•					•		•		1 to ∞	54 MHz	WREN
Augmented Storage Array Instructions																						
46	Read Augmented Storage Array - SDR	RDAS 4Bh			•												•		•	1 to 256	50 MHz	
47	Write Augmented Storage Array - SDR	WRAS 42h			•												•			1 to 256	108 MHz	WREN

Notes:

1: A typical SPI instruction consists of command, address and data components. The bus width to transmit these three components varies based on the SPI interface mode selected. To accurately represent the number of I/Os used to transmit these three components, a nomenclature (command-address-data) is adopted and used throughout this document. Integers placed in the (command-address-data) fields represent the number of I/Os used to transmit the particular component. As an example, 1-1-1 means command, address and data are

1Mbit – 16Mbit SPI (4-4-4) P-SRAM Memory

transmitted on a single I/O (SI / IO[0] or SO / IO[1]). On the other hand, 1-4-4 represents command being sent on a single I/O (SI / IO[0]) and address/data being sent on four I/Os (IO[3:0]).

2: XIP allows completing a series of read and write instructions without having to individually load the read or write command for each instruction. A special mode byte must be entered after the address bits to enable/disable XIP – Axh / Fxh.

3: Read instruction must include Latency cycles to meet higher frequency. They are configurable (Configuration Register 2 – CR2[3:0]) and frequency dependent.

4: The augmented storage array is 256-Bytes in size. The address bits ADDR[23:8] must be Logic '0' for this instruction.

5: Registers do not wrap data during reads. Reading beyond the specified number of bytes will yield indeterminate data.

6: WREN prerequisite for array writing is configurable (Configuration Register 4 – CR4[1:0]).

7: For the Exit Deep Power Down command, the maximum frequency is 108MHz for 1-1-1 operation and 36MHz for 2-2-2 and 4-4-4 operations.

Instruction Description and Structures

All communication between a host and ASxxxx204 is in the form of instructions. Instructions define the operation that must be executed. Instructions consist of a command followed by an optional address modifier and data transfer to or from ASxxxx204. All command, address and data information is transferred sequentially. Instructions are structured as follows:

- Each instruction begins with CS# going Low (logic '0') and ends with CS# returning High (Logic '1').
- CLK marks the transfer of each bit.
- Each instructions starts out with an 8-bit command. The command selects the type of operation ASxxxx204 must perform. The command is transferred on the rising edges of CLK.
- The command can be stand alone or followed by address to select a memory location or register. The address is always 24-bits wide.
 - SDR: The address is transferred on the rising edges of CLK.
 - DDR: The address is transferred on both edges of the CLK in DDR.
- The address bits are followed by data bits. For Write instructions:
 - SDR: Write data bits to ASxxxx204 are transferred on the rising edges of CLK.
 - DDR: Write data bits to ASxxxx204 are transferred on both edges of CLK.
- In normal operational mode, Write instructions must be preceded by the WREN instruction. WREN instruction sets the WREN bit in the Status register. WREN bit is reset at the end of every Write instruction. WREN bit can also be reset by executing the WRDI instruction. ASxxxx204 offers two other modes, namely SRAM and Back-to-Back Write where WREN does not get reset after a write instruction to the memory array or the augmented storage array. These modes are set in Configuration Register 4.
- Similar to write instructions, the address bits are followed by data bits for read instructions:
 - SDR: Read data bits from ASxxxx204 are transferred on the falling edges of CLK.
 - DDR: Read data bits from ASxxxx204 are transferred on both edges of CLK. The start of read data transfer is always on the falling edge of the CLK.
- ASxxxx204 is a high performance serial memory and at higher frequencies, read instructions require latency cycles to compensate for the memory array access time. The number of latency cycles required depends on the operational frequency and is configurable – Configuration Register 2. The latency cycles are inserted after the address bits before the data comes out of ASxxxx204.
- For Read and Write instructions, ASxxxx204 offers XIP mode. XIP allows similar instructions to be executed sequentially without incurring the command cycles overhead. XIP is enabled by entering byte Axh and disabled by entering byte Fxh. These respective bytes must be entered following the address bits.
- For Read instructions, ASxxxx204 offers wrap mode. Wrap bursts are confined to address aligned 16/32/64/128/256 byte boundary. The read address can start anywhere within the wrap boundary. 16/32/64/128/256 wrap configuration is set in Configuration Register 3.

- The entire memory array can be read from or written to using a single read or write instruction. After the starting address is entered, subsequent address are internally incremented as long as CS# is Low and CLK continues to cycle.
- All commands, address and data are shifted with the most significant bit first.

Figure 9 to Figure 25 show the description of SDR instruction types supported.

Figure 9: Description of (1-0-0) Instruction Type



Figure 10: Description of (1-0-1) Instruction Type



Figure 11: Description of (1-1-1) Instruction Type (Without XIP)



Figure 12: Description of (1-1-1) Augmented Storage Instruction Type



Figure 13: Description of (1-1-1) Instruction Type (With XIP)



Figure 14: Description of (1-1-2) Instruction Type (With XIP)

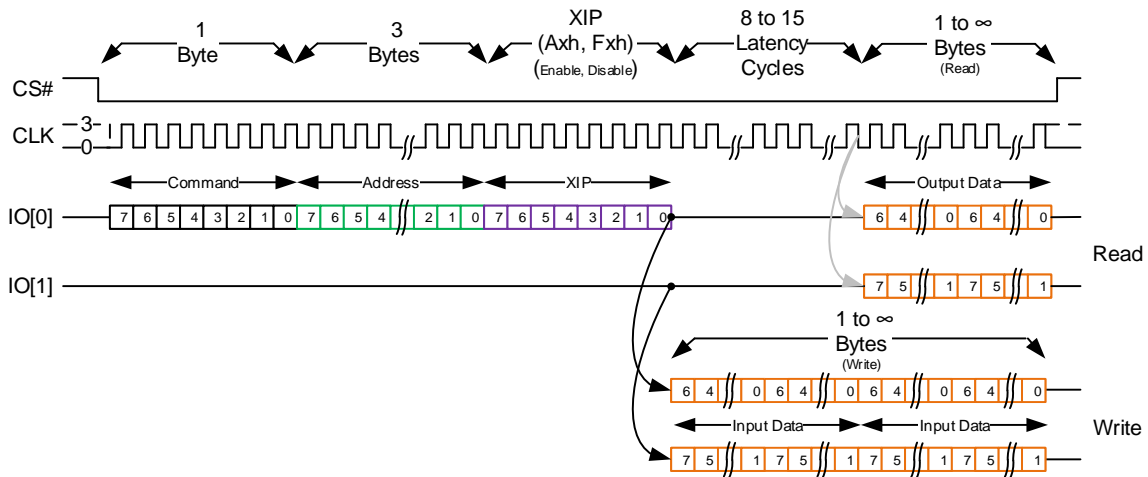

Figure 15: Description of (1-2-2) Instruction Type (With XIP)

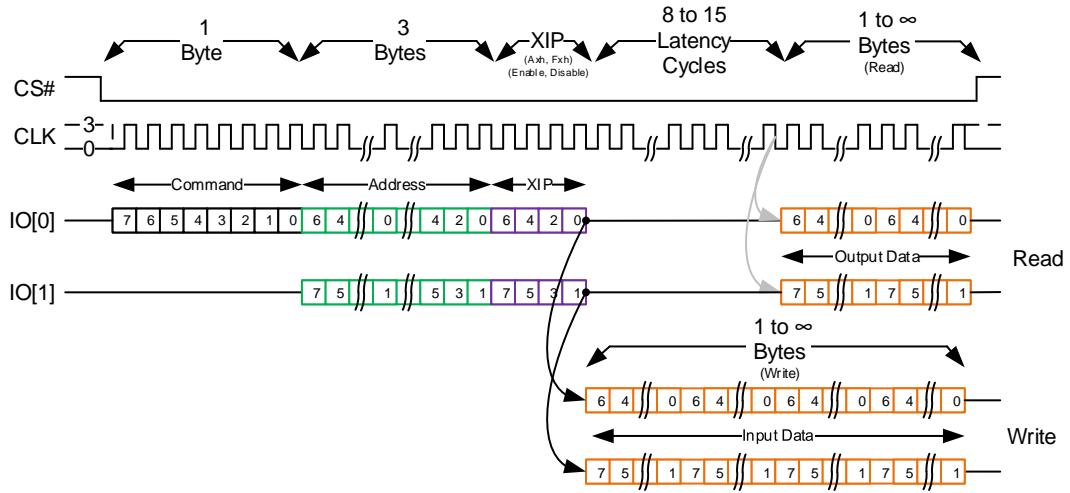

Figure 16: Description of (2-0-0) Instruction Type

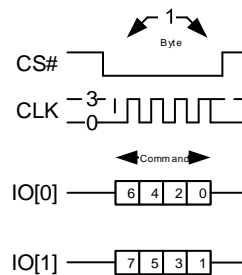

Figure 17: Description of (2-0-2) Instruction Type

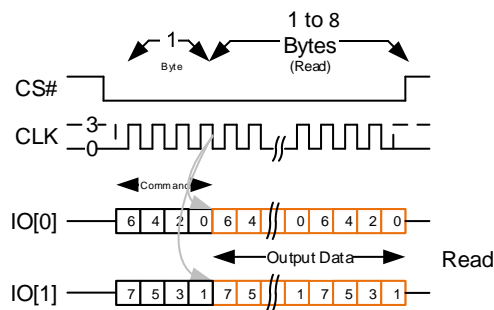

Figure 18: Description of (2-2-2) Any Register Instruction Type



Figure 19: Description of (2-2-2) Instruction Type (With XIP)



Figure 20: Description of (1-1-4) Instruction Type (With XIP)

Figure 21: Description of (1-4-4) Instruction Type (With XIP)

Figure 22: Description of (4-0-0) Instruction Type

Figure 23: Description of (4-0-4) Instruction Type

Figure 24: Description of (4-4-4) Any Register Instruction Type (Without XIP)

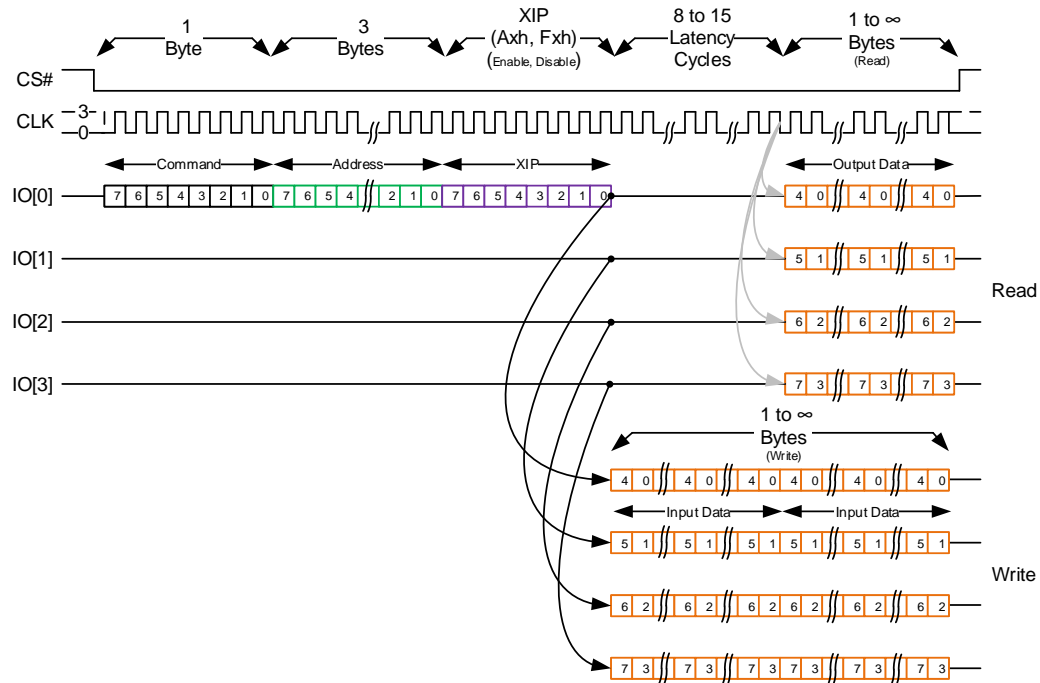
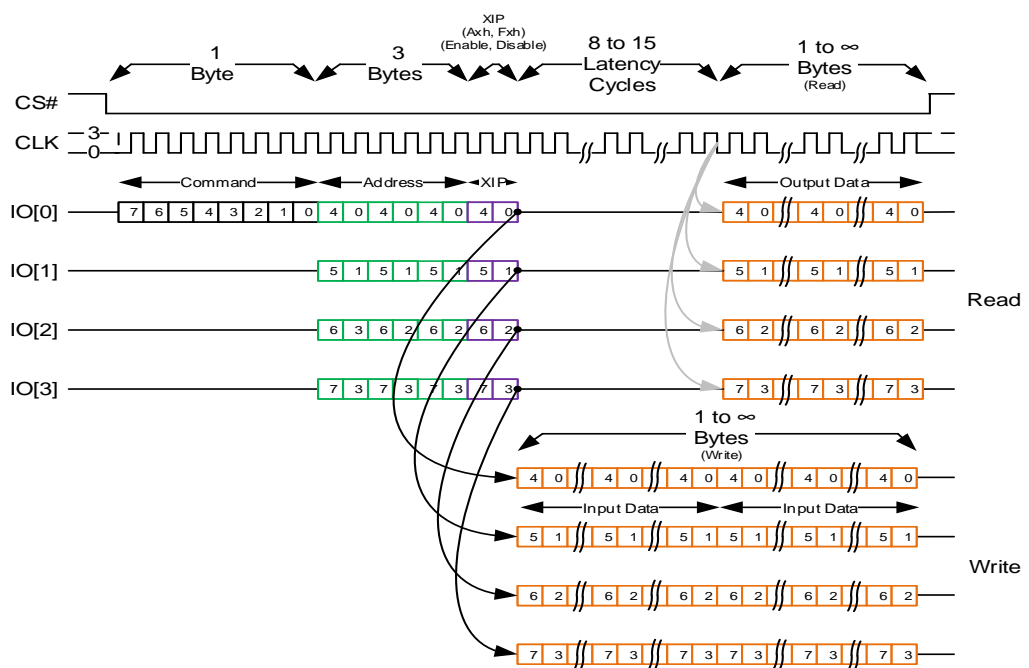
Figure 25: Description of (4-4-4) Instruction Type (With XIP)

Figure 26 to Figure 30 show the description of DDR instruction types supported.

Figure 26: Description of (1-1-1) DDR Instruction Type (With XIP)

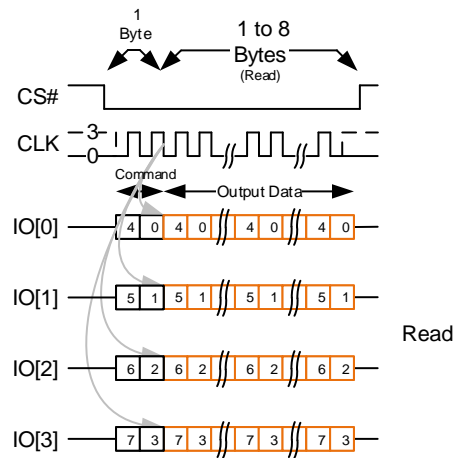
Figure 27: Description of (2-2-2) DDR Instruction Type (With XIP)

Figure 28: Description of (4-4-4) DDR Instruction Type (With XIP)

Figure 29: Description of (1-2-2) DDR Instruction Type (With XIP)

Figure 30: Description of (1-4-4) DDR Instruction Type (With XIP)

Electrical Specifications

Table 29: Recommended Operating Conditions

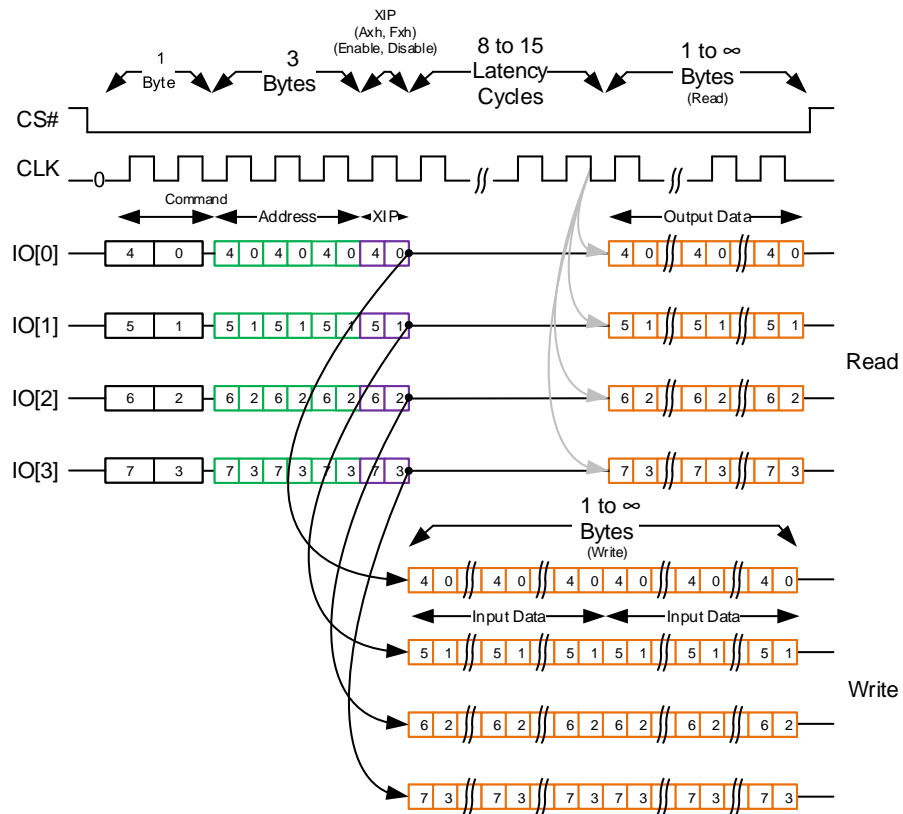
Parameter / Condition		Minimum	Typical	Maximum	Units
Operating Temperature	Industrial	-40.0	-	85.0	°C
	Industrial Plus	-40.0	-	105.0	°C
V _{CC} Supply Voltage (3.0V)	3.0V	2.7	3.0	3.6	V
V _{CC} Supply Voltage (1.8V)	1.8V	1.71	1.8	2.0	V
V _{SS} Supply Voltage		0.0	0.0	0.0	V

Table 30: Pin Capacitance

Parameter	Test Conditions	Symbol	Maximum	Units
Input Pin Capacitance	TEMP = 25°C; f = 1 MHz; V _{IN} = 3.0V	C _{IN}	5.0	pF
Output Pin Capacitance	TEMP = 25°C; f = 1 MHz; V _{IN} = 3.0V	C _{INOUT}	6.0	pF

Table 31: Endurance & Data Retention

Parameter	Symbol	Test Conditions	Minimum	Units
Write Endurance	END	-	10 ¹⁴	cycles
Data Retention	RET	105°C	10	years
		85°C	1,000	
		75°C	10,000	
		65°C	1,000,000	

Table 32: 3.0V DC Characteristics

Parameter	Symbol	Test Conditions	3.0V Device (2.7V-3.6V)			Units	
			Minimum	Typical	Maximum		
Read Current (1-1-1) SDR	I _{READ1}	V _{CC} = 3.6V, I _{OUT} =0mA, CLK=54MHz (V _{IL} / V _{IH}), CS#= V _{IL} , SI= V _{IL} or V _{IH}	-	8	9	mA	
Read Current (2-2-2) SDR	I _{READ2}		-	9	10	mA	
Read Current (4-4-4) SDR	I _{READ3}		-	10	12	mA	
Read Current (1-1-1) SDR	I _{READ4}	V _{CC} = 3.6V, I _{OUT} =0mA, CLK=108MHz (V _{IL} / V _{IH}), CS#= V _{IL} , SI= V _{IL} or V _{IH}	-	13	15	mA	
Read Current (2-2-2) SDR	I _{READ5}		-	15	17	mA	
Read Current (4-4-4) SDR	I _{READ6}		-	19	21	mA	
Read Current (1-1-1) DDR	I _{READ7}	V _{CC} = 3.6V, I _{OUT} =0mA, CLK=54MHz (V _{IL} / V _{IH}), CS#= V _{IL} , SI= V _{IL} or V _{IH}	-	13	18	mA	
Read Current (2-2-2) DDR	I _{READ8}		-	20	24	mA	
Read Current (4-4-4) DDR	I _{READ9}		-	23	28	mA	
Write Current (1-1-1) SDR	I _{WRITE1}	V _{CC} = 3.6V, I _{OUT} =0mA, CLK=54MHz (V _{IL} / V _{IH}), CS#= V _{IL} , SI= V _{IL} or V _{IH}	-	14	16	mA	
Write Current (2-2-2) SDR	I _{WRITE2}		-	17	20	mA	
Write Current (4-4-4) SDR	I _{WRITE3}		-	22	25	mA	
Write Current (1-1-1) SDR	I _{WRITE4}	V _{CC} = 3.6V, I _{OUT} =0mA, CLK=108MHz (V _{IL} / V _{IH}), CS#= V _{IL} , SI= V _{IL} or V _{IH}	-	22	28	mA	
Write Current (2-2-2) SDR	I _{WRITE5}		-	25	32	mA	
Write Current (4-4-4) SDR	I _{WRITE6}		-	38	45	mA	
Write Current (1-1-1) DDR	I _{WRITE7}	V _{CC} = 3.6V, I _{OUT} =0mA, CLK=54MHz (V _{IL} / V _{IH}), CS#= V _{IL} , SI= V _{IL} or V _{IH}	-	15	25	mA	
Write Current (2-2-2) DDR	I _{WRITE8}		-	20	30	mA	
Write Current (4-4-4) DDR	I _{WRITE9}		-	30	45	mA	
Standby Current	I _{SB}	V _{CC} = 3.6V, CLK=V _{CC} , CS#=V _{CC} , SI=V _{CC}	Ta = 25°C	-	160	-	µA
			Ta = 85°C	-	-	400	µA
			Ta = 105°C	-	-	600	µA
Deep Power Down Current	I _{DPD}	V _{CC} = 3.6V, CLK=V _{CC} , CS#=V _{CC} , SI=V _{CC}	-	5	25	µA	
Hibernate Current	I _{HBN}	V _{CC} = 3.6V, CLK=V _{CC} , CS#=V _{CC} , SI=V _{CC}	-	0.1	-	µA	
Input Leakage Current	I _{LI}	V _{IN} =0 to V _{CC} (max)	-	-	±1.0	µA	
Output Leakage Current	I _{LO}	V _{OUT} =0 to V _{CC} (max)	-	-	±1.0	µA	
Input High Voltage	V _{IH}		0.7xV _{CC}	-	V _{CC} +0.3	V	
Input Low Voltage	V _{IL}		-0.3	-	0.3xV _{CC}	V	
Output High Voltage Level	V _{OH}	I _{OH} = -100µA	V _{CC} -0.2	-	-	V	
		I _{OH} = -1mA	2.4	-	-	V	
Output Low Voltage Level	V _{OL}	I _{OL} = 150µA	-	-	0.2	V	
		I _{OL} = 2mA	-	-	0.4	V	

Table 33: 1.8V DC Characteristics

Parameter	Symbol	Test Conditions	1.8V Device (1.71V-2.0V)			Units	
			Minimum	Typical	Maximum		
Read Current (1-1-1) SDR	I _{READ1}	V _{CC} = 2.0V, I _{OUT} =0mA, CLK=54MHz (V _{IL} / V _{IH}), CS#= V _{IL} , SI= V _{IL} or V _{IH}	-	5	8	mA	
Read Current (2-2-2) SDR	I _{READ2}		-	6	9	mA	
Read Current (4-4-4) SDR	I _{READ3}		-	7	11	mA	
Read Current (1-1-1) SDR	I _{READ4}	V _{CC} = 2.0V, I _{OUT} =0mA, CLK=108MHz (V _{IL} / V _{IH}), CS#= V _{IL} , SI= V _{IL} or V _{IH}	-	8	12	mA	
Read Current (2-2-2) SDR	I _{READ5}		-	9	13	mA	
Read Current (4-4-4) SDR	I _{READ6}		-	12	17	mA	
Read Current (1-1-1) DDR	I _{READ7}	V _{CC} = 2.0V, I _{OUT} =0mA, CLK=54MHz (V _{IL} / V _{IH}), CS#= V _{IL} , SI= V _{IL} or V _{IH}	-	11	14	mA	
Read Current (2-2-2) DDR	I _{READ8}		-	17	20	mA	
Read Current (4-4-4) DDR	I _{READ9}		-	21	25	mA	
Write Current (1-1-1) SDR	I _{WRITE1}	V _{CC} = 2.0V, I _{OUT} =0mA, CLK=54MHz (V _{IL} / V _{IH}), CS#= V _{IL} , SI= V _{IL} or V _{IH}	-	13	15	mA	
Write Current (2-2-2) SDR	I _{WRITE2}		-	16	19	mA	
Write Current (4-4-4) SDR	I _{WRITE3}		-	20	23	mA	
Write Current (1-1-1) SDR	I _{WRITE4}	V _{CC} = 2.0V, I _{OUT} =0mA, CLK=108MHz (V _{IL} / V _{IH}), CS#= V _{IL} , SI= V _{IL} or V _{IH}	-	20	26	mA	
Write Current (2-2-2) SDR	I _{WRITE5}		-	23	30	mA	
Write Current (4-4-4) SDR	I _{WRITE6}		-	36	43	mA	
Write Current (1-1-1) DDR	I _{WRITE7}	V _{CC} = 2.0V, I _{OUT} =0mA, CLK=54MHz (V _{IL} / V _{IH}), CS#= V _{IL} , SI= V _{IL} or V _{IH}	-	13	23	mA	
Write Current (2-2-2) DDR	I _{WRITE8}		-	19	28	mA	
Write Current (4-4-4) DDR	I _{WRITE9}		-	28	43	mA	
Standby Current	I _{SB}	V _{CC} = 2.0V, CLK=V _{CC} , CS#=V _{CC} , SI=V _{CC}	Ta = 25°C	-	140	-	µA
			Ta = 85°C	-	-	350	µA
			Ta=105°C	-	-	500	µA
Deep Power Down Current	I _{DPD}	V _{CC} = 2.0V, CLK=V _{CC} , CS#=V _{CC} , SI=V _{CC}	-	4	20	µA	
Hibernate Current	I _{HBN}	V _{CC} = 2.0V, CLK=V _{CC} , CS#=V _{CC} , SI=V _{CC}	-	0.1	-	µA	
Input Leakage Current	I _{LI}	V _{IN} =0 to V _{CC} (max)	-	-	±1.0	µA	
WP# Leakage Current	I _{WP#LI}	V _{IN} =0 to V _{CC} (max)	-100.0	-	+1.0	µA	
Output Leakage Current	I _{LO}	V _{OUT} =0 to V _{CC} (max)	-	-	±1.0	µA	
Input High Voltage	V _{IH}		0.7xV _{CC}	-	V _{CC} +0.3	V	
Input Low Voltage	V _{IL}		-0.3	-	0.3xV _{CC}	V	
Output High Voltage Level	V _{OH}	I _{OH} = -100µA	V _{CC} -0.2	-	-	V	
		I _{OH} = -1mA	1.5	-	-	V	
Output Low Voltage Level	V _{OL}	I _{OL} = 150µA	-	-	0.2	V	
		I _{OL} = 2mA	-	-	0.4	V	

Absolute Maximum Ratings

Stresses greater than those listed may cause permanent damage to the device. This is a stress rating only. Exposure to maximum rating for extended periods may adversely affect reliability.

Table 34: Absolute Maximum Ratings

Parameter	Minimum	Maximum	Units
Magnetic Field During Write	---	24000	A/m
Magnetic Field During Read	---	24000	A/m
Junction Temperature	---	125	°C
Storage Temperature	-55 to 150		°C
ESD HBM (Human Body Model) ANSI/ESDA/JEDEC JS-001-2017	≥ 2000 V		V
ESD CDM (Charged Device Model) ANSI/ESDA/JEDEC JS-002-2018	≥ 500 V		V
Latch-Up (I-test) JESD78	≥ 100 mA		mA
Latch-Up (Vsupply over-voltage test) JESD78	Passed		---

Table 35: AC Test Conditions

Parameter	Value
Input pulse levels	0.0V to V _{CC}
Input rise and fall times	3.0ns
Input and output measurement timing levels	V _{CC} /2
Output Load	CL = 30.0pF

CS# Operation & Timing

Figure 31: CS# Operation & Timing

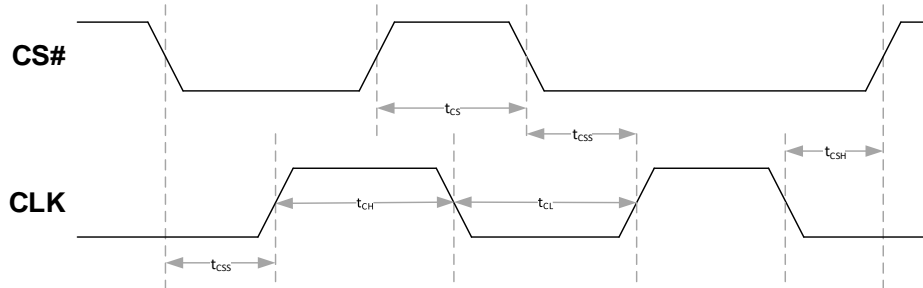

Table 36: CS# Operation

Parameter	Symbol	Minimum	Maximum	Units
Clock Frequency	f_{CLK}	1	108 (SDR)	MHz
Clock Low Time	t_{CL}	$0.45 * 1 / f_{CLK}$	-	ns
Clock High Time	t_{CH}	$0.45 * 1 / f_{CLK}$	-	ns
Chip Deselect Time after Read Cycle	t_{CS1}	20	-	ns
Chip Deselect Time after Register Write Cycle¹	t_{CS2}	5	-	μ s
Chip Deselect Time after Write Cycle (SPI)	t_{CS3}	280	-	ns
Chip Deselect Time after Write Cycle (DPI)	t_{CS4}	350	-	ns
Chip Deselect Time after Write Cycle (QPI)	t_{CS5}	490^2	-	ns
CS# Setup Time (w.r.t CLK)	t_{CSS}	5	-	ns
CS# Hold Time (w.r.t CLK)	t_{CSH}	4	-	ns

Notes:

Power supplies must be stable

1:SDR operation only

2:For single byte operations, t_{CS5} is 280ns

Command, Address, XIP and Data Input Operation & Timing

Figure 32: SDR Command, Address and Data Input Operation & Timing



Table 37: SDR Command, Address, XIP, and Data Input Operation & Timing

Parameter	Symbol	Minimum	Maximum	Units
Data Setup Time (w.r.t CLK)	t_{SU}	2.0	-	ns
Data Hold Time (w.r.t CLK)	t_{HD}	3.0	-	ns

Notes:

Power supplies must be stable

Figure 33: DDR Command, Address and Data Input Operation & Timing

Table 38: DDR Command, Address, XIP, and Data Input Operation & Timing

Parameter	Symbol	Minimum	Maximum	Units
Data Setup Time (w.r.t CLK)	t_{SU}	4.0	-	ns
Data Hold Time (w.r.t CLK)	t_{HD}	4.0	-	ns

Notes:

Power supplies must be stable

Data Output Operation & Timing

Figure 34: SDR Data Output Operation & Timing



Table 39: SDR Data Output Operation & Timing

Parameter	Symbol	Minimum	Maximum	Units
CLK Low to Output Low Z (Active)	t_{CLZ}	0	-	ns
Output Valid (w.r.t CLK)	t_{CO}	-	7.0	ns
Output Hold Time (w.r.t CLK)	t_{OH}	1.0	-	ns
Output Disable Time (w.r.t CS#)	t_{HZCS}	-	7.0	ns

Notes:

Power supplies must be stable

Figure 35: DDR Data Output Operation & Timing

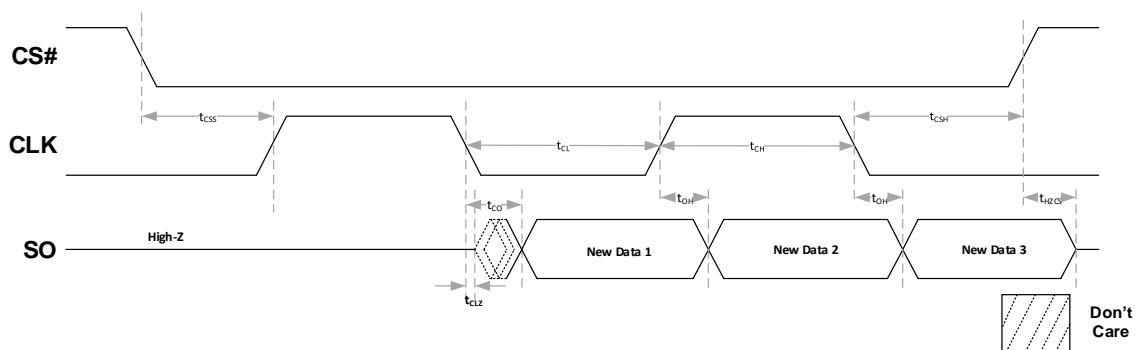

Table 40: DDR Data Output Operation & Timing

Parameter	Symbol	Minimum	Maximum	Units
CLK Low to Output Low Z (Active)	t_{CLZ}	0	-	ns
Output Valid (w.r.t CLK)	t_{CO}	-	7.0	ns
Output Hold Time (w.r.t CLK)	t_{OH}	1.0	-	ns
Output Disable Time (w.r.t CS#)	t_{HZCS}	-	6.0	ns

Notes:

Power supplies must be stable

WP# Operation & Timing

Figure 36: WP# Operation & Timing

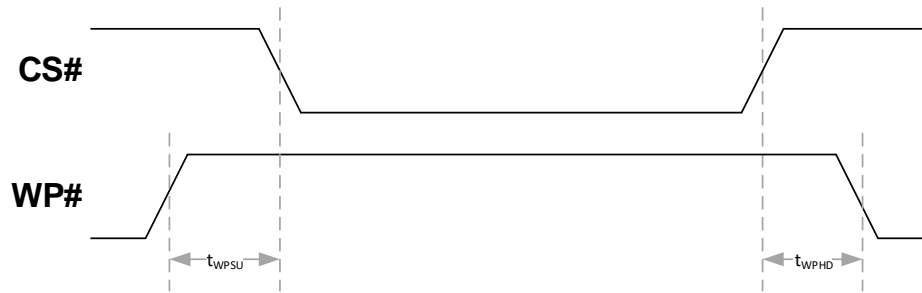

Table 41: WP# Operation & Timing

Parameter	Symbol	Minimum	Maximum	Units
WP# Setup Time (w.r.t CS#)	t_{WPSU}	20	-	ns
WP# Hold Time (w.r.t CS#)	t_{WPHD}	20	-	ns

Notes:

Power supplies must be stable

JEDEC Reset Operation & Timing

Figure 37: JEDEC Reset Operation & Timing



Table 42: JEDEC Reset Operation & Timing

Parameter	Symbol	Minimum	Maximum	Units
CS# Low Time	t _{CL}	1.0	-	μs
CS# High Time	t _{CH}	1.0	-	μs
SI Setup Time (w.r.t CS#)	t _{SU}	5.0	-	ns
SI Hold Time (w.r.t CS#)	t _{HD}	5.0	-	ns
JEDEC Hardware Reset	t _{RESET}	-	450.0	μs
Software Reset¹	t _{SRST}	-	50.0	μs

Notes:

Power supplies must be stable

1: Software Reset timing is for Instruction based Reset (SRST)

Enter Deep Power Down Command (EDP – B9h)

The command sequences are shown below. Executing the Enter Deep Power down (EDP) command is the only way to put the device in the deep power down mode. The device consumption drops to I_{DP} .

The deep power down mode subsequently reduces the standby current from I_{SB} to I_{DP} . No other command must be issued while the device is in deep power down mode.

To enter the deep power down mode, CS# is driven low, following the enter deep power down (EDPD) command, CS# must be driven high after the eighth bit of the command code has been latched in or the EDP command will not be executed. After CS# is driven high, it requires a delay of t_{EDPD} (Table 6 and 7) before the supply current is reduced to I_{DP} and the Deep Power Down mode is entered. The command can be issued in SPI or QPI modes.

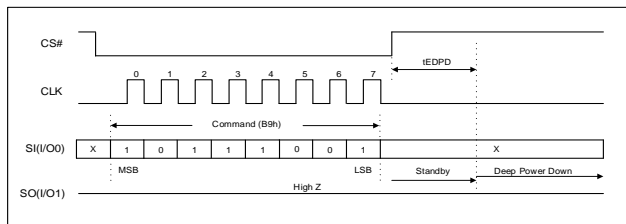

Figure 38: Enter Deep Power Down in SPI Command Sequence

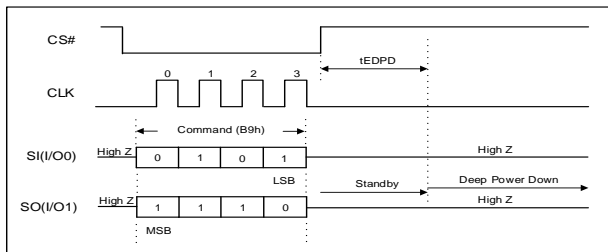

Figure 39: Enter Deep Power Down in DPI Command Sequence

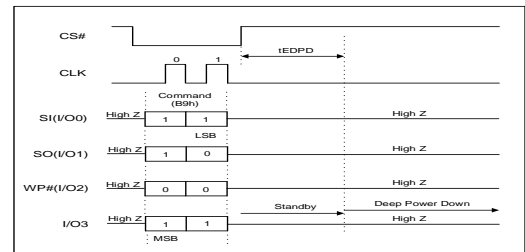

Figure 40: Enter Deep Power Down in QPI Command Sequence

Exit Deep Power Down Command (EXDPD - ABh)

The command sequences are shown below. There are two ways to exit deep power down mode:

1. Toggling CS# with a CS# pulse width of t_{CSDPD} while CLK and I/Os are Don't Care. During waking up from deep power down, I/Os remain to be in high Z.
2. Driving CS# low follows with the Exit Deep Power Down (EXDPD) command. CS# must be driven high after the eight bit of the command code has been latched in or the EXDPD command will not executed.



Figure 41: Exit Deep Power Down by Toggling CS#



Figure 42: Exit Deep Power Down in SPI Command Sequence

It requires a delay of t_{EXDPD} (Table 6 and 7) before the device can fully exit the deep power down mode and enter standby mode. The command can be issued in SPI, DPI, and QPI mode. Status of all non-volatile bits in registers remains unchanged when the device enters or exits the deep power down mode.



Figure 43: Exit Deep Power Down in DPI Command Sequence



Figure 44: Exit Deep Power Down in QPI Command Sequence

Enter Hibernate Command (EHBN – BAh)

The command sequences are shown below. Executing the Enter Hibernate command is the only way to put the device in the hibernate mode. The device drops down to the lowest power consumption mode: I_{HBN} . When in hibernate mode, the CLK and SI pins are ignored and SO will be high-Z.

To enter the hibernate mode, CS# is driven low, following the Enter Hibernate (EHBN) command. After CS# is driven high, it requires a delay of t_{ENTHIB} time (Table 6 and 7) before the supply current is reduced to I_{HBN} and hibernate mode is entered.

Toggling CS# (low to high) will return the device to standby mode. The command can be issued in SPI, DPI, and QPI modes.



Figure 45: Enter Hibernate in SPI Command Sequence

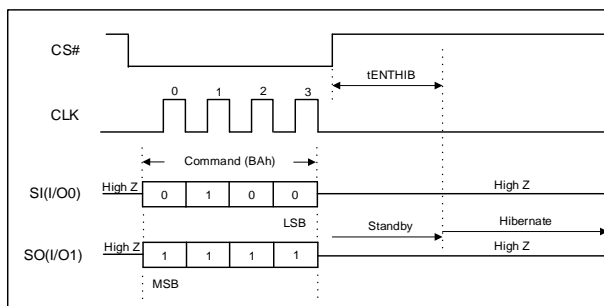

Figure 46: Enter Hibernate in DPI Command Sequence

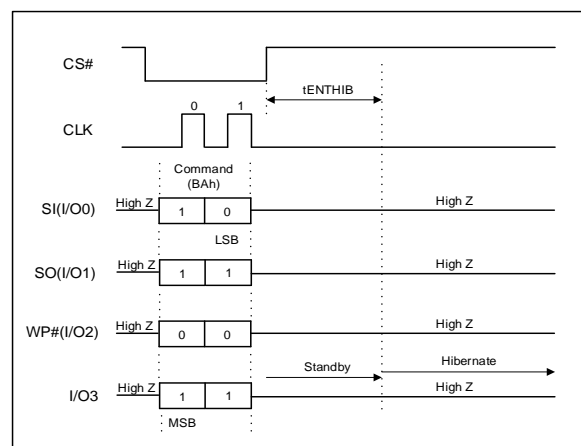

Figure 47: Enter Hibernate in QPI Command Sequence

Thermal Resistance

Table 43: Thermal Resistance

Parameter	Description	Test Conditions	8-pad WSON	8-pin SOIC	Unit
θ_{JA}	Thermal resistance (junction to ambient)	Test conditions follow standard test methods and procedures for measuring thermal impedance, per EIA/JESD51	43.67	53.59	°C/W
θ_{JC}	Thermal resistance (junction to case)		18.54	4.29	

Notes:

1: These parameters are guaranteed by characterization; not tested in production.

Product Use Limitations

Avalanche reserves the right to make changes to the information in this document, and related hardware, software and system (collectively referred to as “**Products**”) without notice. This document supersedes and replaces any and all prior or contemporaneous information or arrangement of any kind relating to the subject matter hereof. This document and any information set forth herein may not be reproduced without the prior written permission from Avalanche.

Critical Applications. Products are not authorized for use in applications in which failure of the Avalanche component could result, directly or indirectly in death, personal injury, or severe property or environmental damage (“**Critical Applications**”). Avalanche assumes no liability for Products if used for Critical Applications. Should customer or distributor purchase, use, or sell any Avalanche component for Critical Applications, customer and distributor shall indemnify and hold harmless Avalanche and its subsidiaries, subcontractors, and affiliates and the directors, officers, and employees of each against all claims, costs, damages, and expenses and reasonable attorneys' fees arising out of, directly or indirectly, any claim of product liability, personal injury, or death arising in any way out of such Critical Application, whether or not Avalanche or its subsidiaries, subcontractors, or affiliates were negligent in the design, manufacture, or warning of the Products.

Automotive Applications. Products are not rated for use in automotive applications unless specified by Avalanche. Avalanche assumes no liability for Products if used for automotive applications. Distributor and customer shall assume the sole risk and liability for such use and shall indemnify and hold Avalanche harmless against all claims, costs, damages, and expenses and reasonable attorneys' fees arising out of, directly or indirectly, any claim of product liability, personal injury, death, or property damage resulting directly or indirectly from any use of Products in automotive applications.

Customer Responsibility. Customers are solely responsible for the design and operation of their systems using Products. It is customer's sole responsibility to determine whether Products are suited for their system. Customers are required to incorporate good safety design measures and adequate safeguards to eliminate risks of personal injury, death, or severe property or environmental damages that could result from failure of Products. **AVALANCHE ASSUMES NO LIABILITY FOR CUSTOMERS' PRODUCT DESIGN OR APPLICATIONS AND DAMAGES OR LOSSES OCCURRING AS A RESULT OF NONCOMPLIANCE WITH APPLICABLE LAWS AND REGULATIONS.**

Products are not to be used in applications that would violate any relevant export laws and regulations of the United States and Japan and all other countries having competent jurisdiction (“Export Laws”) to ensure neither MRAM products nor any direct product thereof is: (i) exported or re-exported directly or indirectly in violation of Export Laws; or (ii) used for any purpose prohibited by the Export Laws, including but not limited to nuclear, chemical, or biological weapons proliferation.

The information contained herein is presented only as guidance for Product use. Avalanche assumes no responsibility for any infringement of patents or any other intellectual property rights of third parties that may result from the use of Products. No license to any intellectual property right is granted by this document, whether expressed or implied. You may not perform compositional, structural, functional or other analysis of Products, or undertake deconvolution or reverse engineering with respect to Products.

Limited Warranty

In no event shall Avalanche and its representatives be liable for any indirect, incidental, punitive, special or consequential damages (including but not limited to loss of use, revenue or profit), whether or not such damages are based on tort, warranty, breach of contract or other legal theory.

In no event shall Avalanche's aggregate liability for any breach, warranty, indemnity or other obligation or liability arising out of or in connection with the sale of Products or the use of any Products exceed the purchase price of the particular Product(s) or services with respect to which losses or damages are claimed.