

Using Allegro ASEK-20 and ASEK70311 Daughterboard with ACS70311 Samples Programmer

By Kasey Hampton,
Allegro MicroSystems

Introduction

This quick guide documents the use of the ACS7031x daughterboard (TED-0003346) and the ASEK-20 (Part #85-0540-004) with the Allegro ACS70311 samples programmer. The ASEK-20 chassis can be seen in Figure 1, and the top and bottom layers of the ASEK-20 ACS70311 daughterboard can be seen in Figure 2. See the Appendix section for the ASEK70311 Daughterboard Schematic.



Figure 1: ASEK-20 Chassis

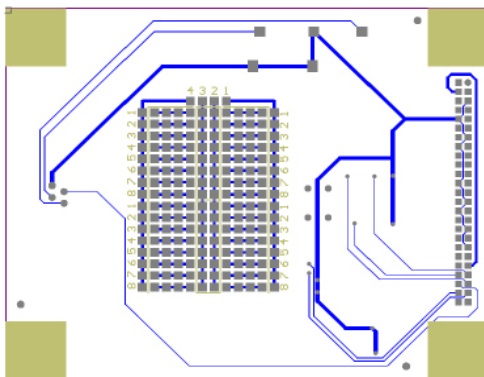
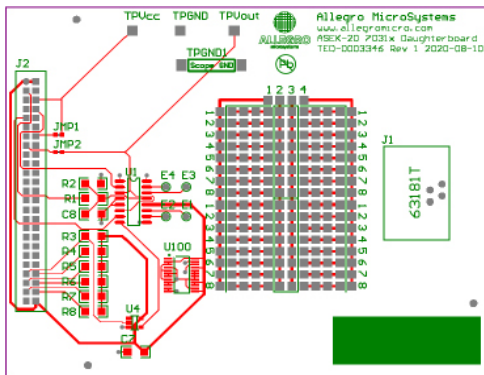

Figure 2: Top and Bottom Layers for ASEK-20 ACS70311 Daughterboard

Downloading the Programmer

1. Register for software on the Allegro Software Portal: <https://registration.allegromicro.com/login>.
2. Ensure that the ASEK-20 being used has the most recent firmware downloaded. Refer to the ASEK-20 firmware webpage (<https://registration.allegromicro.com/parts/ASEK-20>) and the ASEK-20 quick guide under “Support Files” on the ASEK-20 firmware webpage.
3. After registering and logging in to the software portal, the dashboard page will be shown. Choose the “Find a Part” button highlighted in Figure 3.

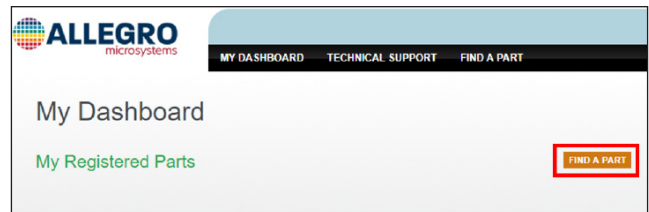

Figure 3: “Find a Part” button allowing the user to register specific devices

4. Click “Find a Part” to go to the “Available Parts & Software” page.
5. Search for “ACS70311” in the “Select by Part Number” search bar shown in Figure 4.

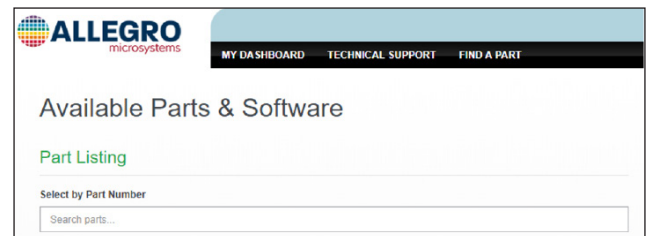

Figure 4: “Select by Part Number” on the Available Parts & Software page

6. Click “View” next to the ACS70311 search result as shown highlighted in Figure 5.

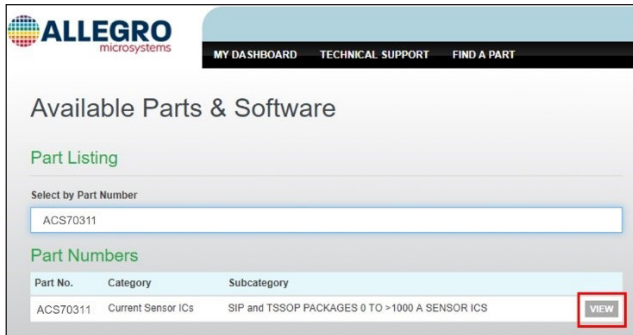

Figure 5: “View” next to “ACS70311” search result

- Click “Download” next to the first result to open the Programming Application ZIP file as highlighted in red in Figure 6.

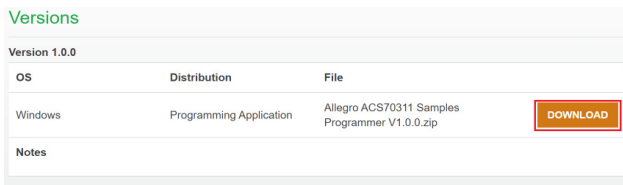

Figure 6: “Download” to open the Programming Application

- Open and extract the downloaded ZIP file and save to a known location.
- Open the extracted ZIP file and open the folder “Allegro ACS70311 Samples Programmer V#”.
- Open the “Allegro ACS70311 Samples Programmer” application file (EXE file extension) to open the samples programmer.

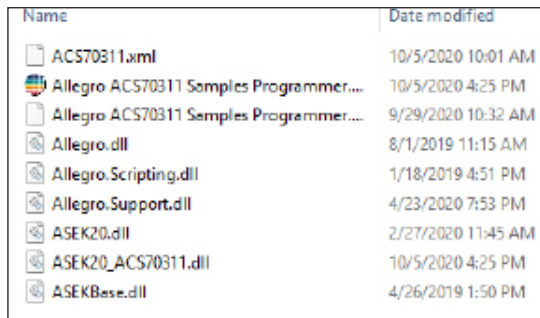

Figure 7: Application file

Connecting ASEK-20 to PC and ASEK70311 Daughterboard

- Connect one end of the USB communications cable to the USB port of a personal computer.
- Connect the other end of the USB communications cable to the “USB” port on the ASEK-20 chassis.
- Connect a ribbon cable to the “J2” connector on the left-hand side of the ACS70311 daughterboard.

- Connect the other end of the ribbon cable to the “Device Connection” port on the ASEK-20 chassis as shown in Figure 8.

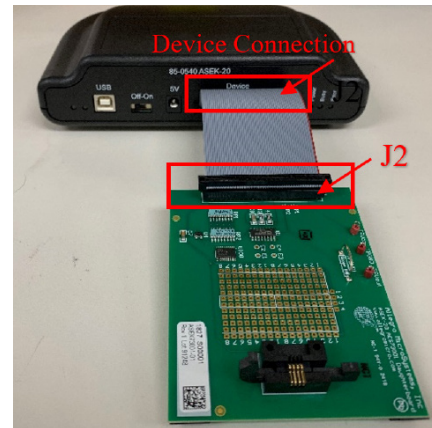

Figure 8: Connection between ASEK-20 and ASEK70311 Daughterboard

- Connect the DC Power Supply/Cable to the 5 V port on the ASEK-20 chassis.
- Plug in the DC Power Supply to a 110/220 AC 60/50 Hz outlet with the appropriate power adapter.

Inserting ACS70311 into ACS70311 Daughterboard

The ACS70311 coreless current sensor is offered in through-hole, TN leadform (KT and OK) and surface-mount, TH leadform (KT only). Leadforming options are shown in Figure 9. For more information, refer to the ACS70310 and ACS70311 device datasheet.

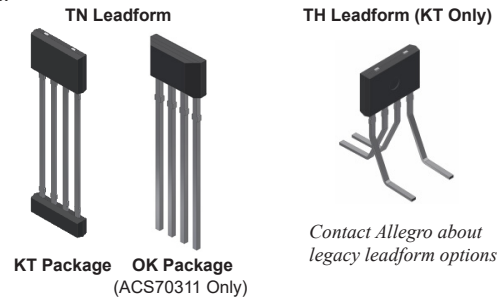

Figure 9: KT and OK Lead-forming Options

To insert the ACS70311 into the ACS70311 daughterboard, do the following:

- Place the ACS70311 in the socket labeled “J1” with pin 1 of the part farthest away from the “J1” label.
- Ensure that the ejector pin mark is on the side facing down into the socket as stated in the pinout diagram in the ACS70311 datasheet (see Figure 10).
- Secure the part in place using the clamps on the left and right

side of the socket.

4. See Figure 11 showing the ACS70311 in “J1” socket.

Proceed to Using the Programmer section below.

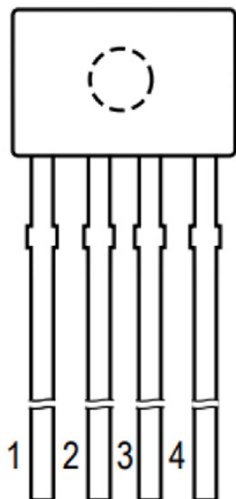

Figure 10: Package Pinout Diagram (ejector pin mark on opposite side)

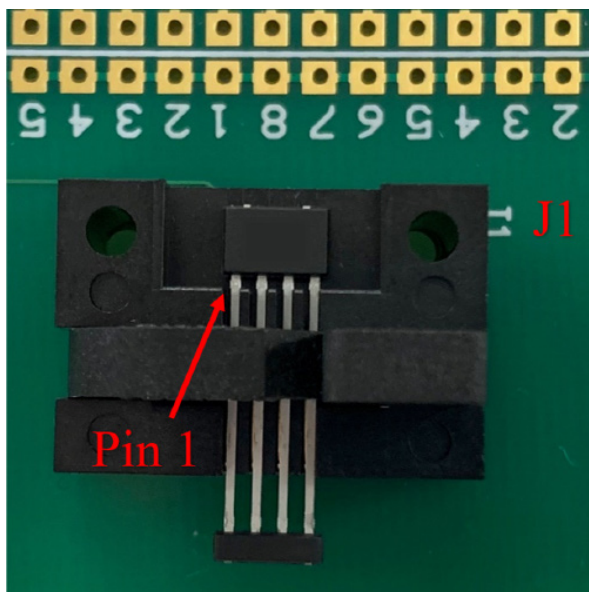

Figure 11: ACS70311 in “J1” socket

Using the Programmer

Connecting to the ASEK-20

Opening the programmer will result in a window identical to Figure 12 below.

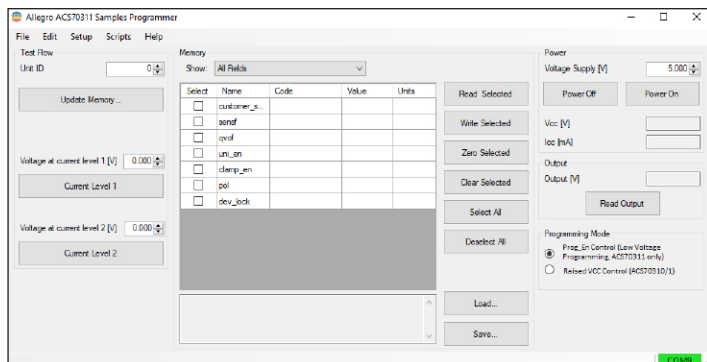

Figure 12: ACS70311 Programmer Application

To connect the ASEK-20, click “Setup” → “Communication Setup”. The dialog box in Figure 13 will appear. Click the correct COM# in the pulldown menu next to COM Port. If the COM port is unknown, do the following:

1. Unplug the USB cable to the ASEK-20.
2. Click “Refresh” in the “Communication Setup” dialog window as highlighted in blue in Figure 13.
3. Click on the “COM Port” pulldown menu.
4. Note which ports are in the menu.
5. Plug the USB cable back into the ASEK-20.
6. Click “Refresh”.
7. Click the “COM Port” popup menu again.
8. Note the COM port not previously listed in the menu; this is the port connected to the ASEK-20.
9. Select this COM port to use.

Once the correct COM port is selected and the ASEK-20 is connected to the PC, verify next to “Communication” the status of the ASEK-20.

If the status is “Active”, the ASEK-20 is powered and responding. If the status is “Inactive”, the ASEK-20 is not responding or powered on. If this is the case, click “Refresh” and ensure the ASEK-20 chassis is plugged into the PC and the chassis is powered on.

Click “OK” to exit the dialog box.

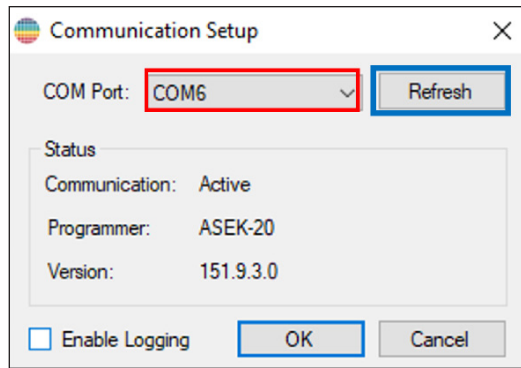

Figure 13: Communication Setup dialog box

Status Bar

The green or red colored rectangle on the right side of the status bar shown highlighted in red in Figure 14 indicates the status of the communication with the ASEK. If the status bar is red, the communication is not active and if green, the application is communicating with the ASEK. The COM port that is currently set is overlaid on the colored rectangle. Clicking on the rectangle will open the Communication setup dialog window.



Figure 14: Status bar on the bottom right hand side of GUI

Turning the Part ON and OFF

To power on the part using the ASEK-20, click “Power On” on the right-hand side of the programmer as show in red in Figure 15.

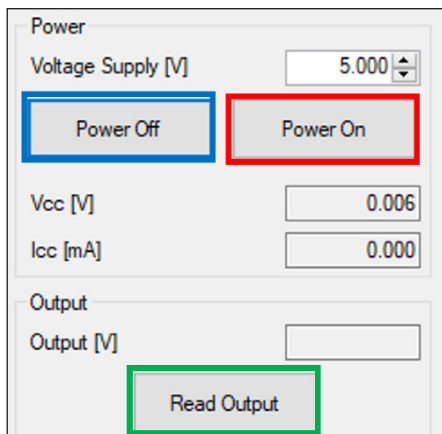

Figure 15: “Power On”, “Power Off”, and “Read Output”

Once the part is powered on, values for “ V_{CC} [V]” and “ I_{CC} [mA]” will populate with the measured values. Verify that the voltage is what is desired and that the device is consuming approximately 13 mA (maximum of 15 mA).

To read the output of the ACS70311, select “Read Output” highlighted green in Figure 15. Verify the Output [V] is a reasonable number, around 2.5 volts with zero external field applied if testing a bidirectional part with 5 volts typical VCC (0.5 volts with zero external field applied for a unidirectional device).

To turn the part off, select “Power Off” to the left of “Power On”, highlighted in blue in Figure 14 above. Clicking “Power Off” will cause ICC to fall to ≈ 0 mA.

Read and Writing to the Part

Note before reading and writing to the part, the part must be connected and powered on using the programmer GUI.

It is recommended that the user save the memory to a tabular file before experimenting with programming so the user can return the device to its original factory programmed state if necessary. See the Saving and Loading Memory Files section below.

To read a field, select the desired field by checking the box under “Select” to the left of the register name and click the “Read Selected” button highlighted in red in Figure 15.

To write to a field, select the desired field by checking the box under “Select” to the left of the name. Change the value under “Code” to the desired value and press Enter. Click “Write Selected” button highlighted in blue in Figure 15.

To verify that field was written to the device, do the following: click “Clear Selected” causing the values in the “Code” and “Value” cells to disappear. Then click “Read Selected”. The values that were written will reappear in the “Code” and “Value” cells verifying the user correctly wrote to the part.

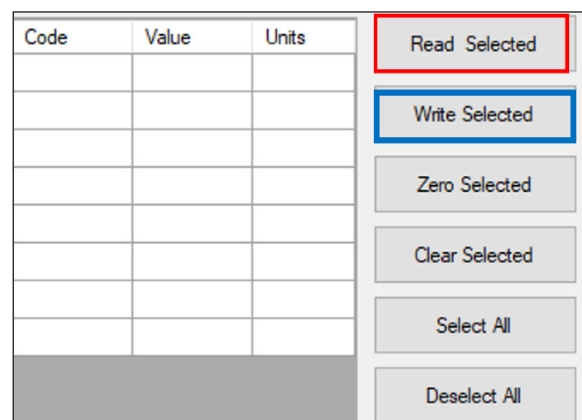

Figure 16: “Read Selected” and “Write Selected” buttons

Below, each option on the programmer menu has been briefly defined:

- **Read Selected:** reads value of the selected field.
- **Write Selected:** writes entered value to the part.
- **Zero Selected:** this option will zero the selected field but will not write zero to the device unless “Write Selected” is clicked.
- **Clear Selected:** this option will hide and clear the value of the selected field but will not change the value.
- **Select All:** selects all fields.
- **Deselect All:** deselects any and all selected fields.

Note that clicking on the name of a selected field will define the field to the user (see Figure 16). Hovering over a field with the PC cursor will tell the user the address of that field (see Figure 18).

Select	Name	Code	Value	Units
<input type="checkbox"/>	customer_scratch			
<input type="checkbox"/>	sensf			
<input type="checkbox"/>	qvof			
<input type="checkbox"/>	sensc			
<input type="checkbox"/>	uni_en			
<input type="checkbox"/>	clamp_en			
<input type="checkbox"/>	pol			
<input type="checkbox"/>	dev_lock			

Quiescent Output Voltage (QVO), fine adjustment

Figure 17: Field definition by clicking desired field

Select	Name	Code	Value	Units
<input type="checkbox"/>	customer_scratch			
<input type="checkbox"/>	sensf			
<input type="checkbox"/>	qvof			
<input type="checkbox"/>	sensc			
<input type="checkbox"/>	uni_en			

qvof (Address: 0x05, bits 17:9)

Figure 18: Hovering over a field shows the address

Accessing the Register Diagram

To access the register diagram, hover over “Help” on the menu bar. Select “ACS70311 Register Diagram”. This will open a dialog window identical to the window in Figure 18 below. See the appendix section below for a larger register diagram.

Address	25	24	23	22	21	20	19	18	17	16	15	14	13	12	11	10	09	08	07	06	05	04	03	02	01	00		
0x04	customer_scratch																											
0x05	sensc				qvof				sensf																			
0x06	dev_l								pol								clamp_en								cl			

Figure 19: ACS70311 Register Diagram

Manchester Programming Protocol

Under “Setup” → “Device Setup...”, the dialog menu in Figure 20 below will appear. In this menu, the user can change various characteristics of the Manchester programming protocol used by the ASEK-20. To restore these settings to their default settings, click “Restore Defaults” as highlighted in red in Figure 20. For more information about the device specific Manchester parameters, see the ACS70310 and ACS70311 device datasheet.

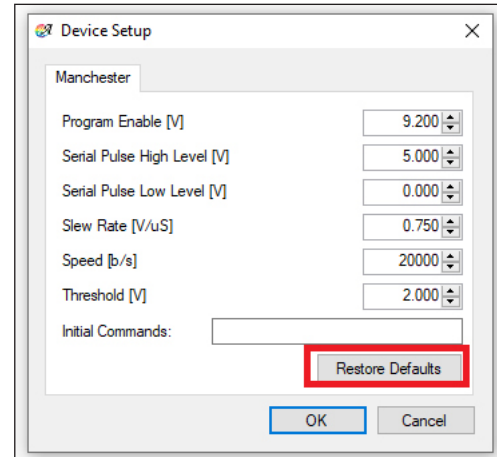

Figure 20: “Device Setup” menu defaults

Below, each Manchester option has been briefly defined:

- **Program Enable [V]:** used to set the voltage for the Program Enable.
- **Serial Pulse High Level [V]:** used to set the voltage for the high level of the Manchester signal.
- **Serial Pulse Low Level [V]:** used to set the voltage for the low level of the Manchester signal.
- **Slew Rate [V/μs]:** used to set the speed at which the Manchester signal will take to get from one voltage to another.
- **Speed [kb/s]:** used to set the bit rate for communication with the ASEK.
- **Threshold [V]:** used to set the threshold for determining the difference between a 1 and a 0 when performing register read.
- **Initial Commands:** used for commands that must be sent to the ASEK-20 when it is being initialized.

Programming Methods Overview

The ACS70311 uses a bidirectional communication on VOUT. The ACS70311 implements two programming methods: Prog_En Control (Low Voltage Programming) and Raised VCC Control.

While the ACS70310 only implements Raised VCC control, the ACS70311 implements both methods. See Figure 21 below for ACS70311 programming diagram. The programming method can be selected when the device is off. In the right hand side of the programmer, the user can select the Programming Mode (see Figure 22). Figure 23 below shows the two programming methods of the ACS70311 on the bench.

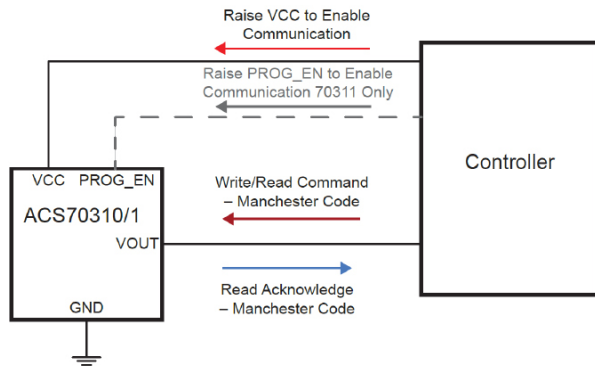

Figure 21: ACS70311 Programming Diagram

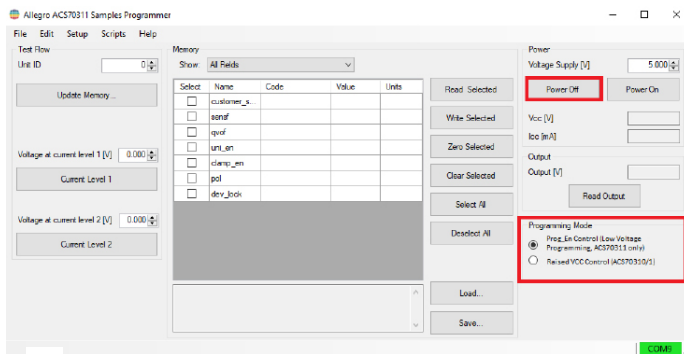

Figure 22: ACS70311 Programming Mode Selection

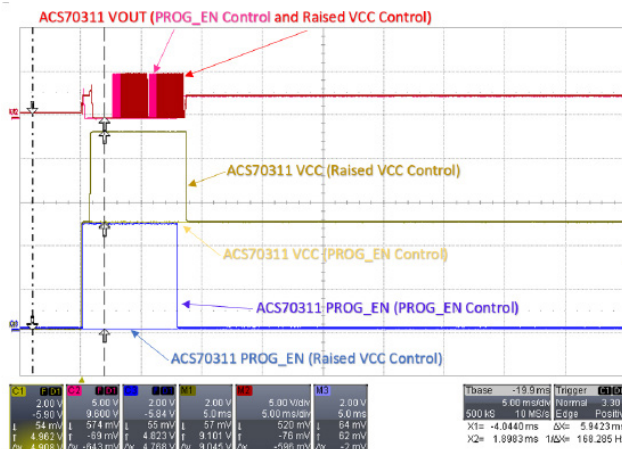

Figure 23: Oscilloscope capture showing the two ACS70311 programming methods

RAISED VCC CONTROL (ACS70310/1)

When the voltage on the VCC pin is increased beyond the programming threshold, the device will enter programming mode.

Note the ACS70311 does not initiate communication; it responds to commands from the external controller. If the command is a write, there is no acknowledging from the ACS70311. If the command is a read, the ACS70311 responds by transmitting the requested data. To initialize any communication, V_{CC} should be increased to a level above V_{prgL} (6.5 V) without exceeding V_{prgH} (9.2 V). At this time, V_{OUT} is disabled and acts as an input.

PROG_EN CONTROL (LOW VOLTAGE PROGRAMMING, ACS70311 ONLY)

The ACS70311 will enter programming enable mode should the voltage on the programming enable pin (PROG_EN) pin exceeds V_{prgH} (PROG_EN). The lower threshold of the programming enable pin allows for communication with the ACS70311 without having to generate signals above 5V.

Saving and Loading Memory Files

To save the memory as a tabular data file or text file, click “Save...” in the bottom right side of the GUI as highlighted in red in Figure 24. Clicking “Save...” will open a file explorer where the user can save the memory information as a CSV file or TXT file. Saving the memory is recommended before experimenting with programming so the user can return the device to its original factory-programmed state if necessary. The user can also save the memory by clicking “File” → “Save Memory...”.

To load a previously saved file containing memory information, click “Load...” as highlighted in green in Figure 24 below. Clicking “Load...” will open a file explorer where the user can navigate to a previously saved CSV or TXT file. The user can also load a memory file by clicking “File” → “Load Memory...”.

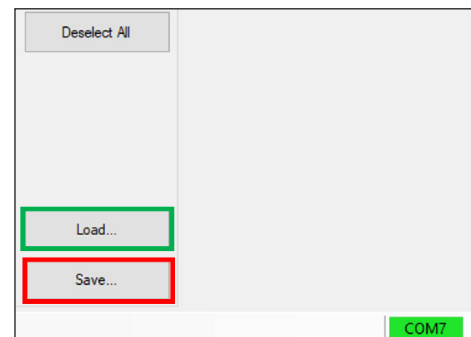

Figure 24: “Load” and “Save” the memory to a tabular file

Two-Point Programming

The goal of two-point programming is to calculate and set device sensitivity using two known points. The user must know the values of the magnetic field and the desired voltage output at two levels.

Prepare a test bench with the ACS70311 evaluation setup, a ferromagnetic core, and current-carrying conductor.

Enter a “Voltage at current level 1 [V]” target value, i.e. 1.5 V. Apply a known magnetic field, i.e. –500 G. Press the “Current Level 1” button. Remove the field once the GUI has finished processing.

Enter a “Voltage at current level 2 [V]” target value, i.e. 3.5 V. Apply the know magnetic field, i.e. 500 G. Press the Current Level 2” button. Remove the field once the GUI has finished processing.

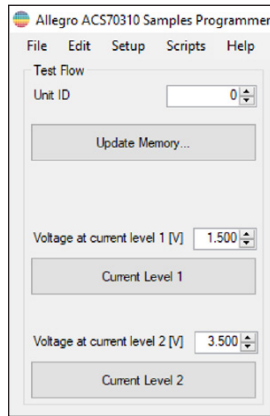

Figure 25: Set level 1 and 2 to desired voltage values

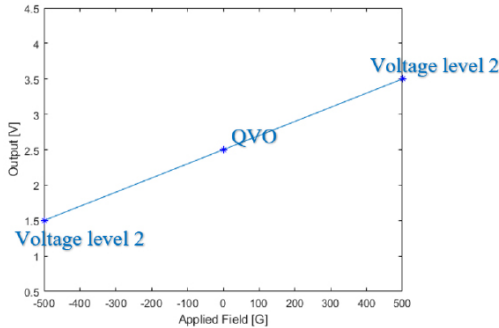

Figure 26: Calculating sensitivity using two known points

For this example, the GUI will set the device sensitivity to 2 mV/G and will set the ‘sensf’ register value accordingly. The device sensitivity is calculated as follows:

$$[(3.5 - 1.5) \text{ V} \times 1000 / 500 \text{ G} = 2 \text{ mV/G.}]$$

The GUI will also set the device offset to 2.5 V and will set the ‘qvo’ register accordingly. The user can now apply 500 G, read the output, and find the output will swing 1 V, 2.5 V to 3.5 V.

TIPS AND TRICKS FOR TWO-POINT PROGRAMMING

The values for ‘sensf’ and ‘qvo’ will be written by the GUI after two-point programming (the user does not have to select “Write Selected”).

The coarse gain value will not automatically update. For example, if the user inputs two voltage levels and field levels that equate to a 10 mV/G device sensitivity and the coarse gain value is currently set to 1, the GUI will produce an error message as the device is unable to have a 10 mV/G sensitivity in coarse gain 1.

Sensitivity Programming Range [G]	Sens _{PR}	0.5	–	1.2	mV/G
	SENS_COARSE = 0	0.5	–	1.2	mV/G
	SENS_COARSE = 1	1.2	–	2.5	mV/G
	SENS_COARSE = 2	2.5	–	5.5	mV/G
	SENS_COARSE = 3	5.5	–	11.5	mV/G

Figure 27: Sensitivity programming range showing sens_coarse values for each sensitivity range

If the user uses a positive field when setting a voltage level below QVO, i.e. the user sets the “Voltage at current level 1 [V]” to be 1.5 V and the applied magnetic field after pressing “Current level 1” is 500 G, the GUI will produce an error message asking the user to flip the polarity bit (“pol”).

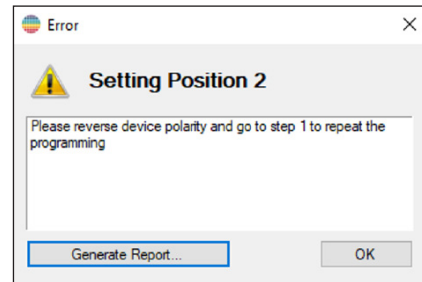

Figure 28: Error message asking to reverse the polarity bit

Appendix

Address	Bit Number																								
	25	24	23	22	21	20	19	18	17	16	15	14	13	12	11	10	09	08	07	06	05	04	03	02	01
0x04	customer_scratch																								
0x05	qvof										sensf														
0x06											dev_id pol clampuni_et														

Figure 29: ACS70311 Register Diagram

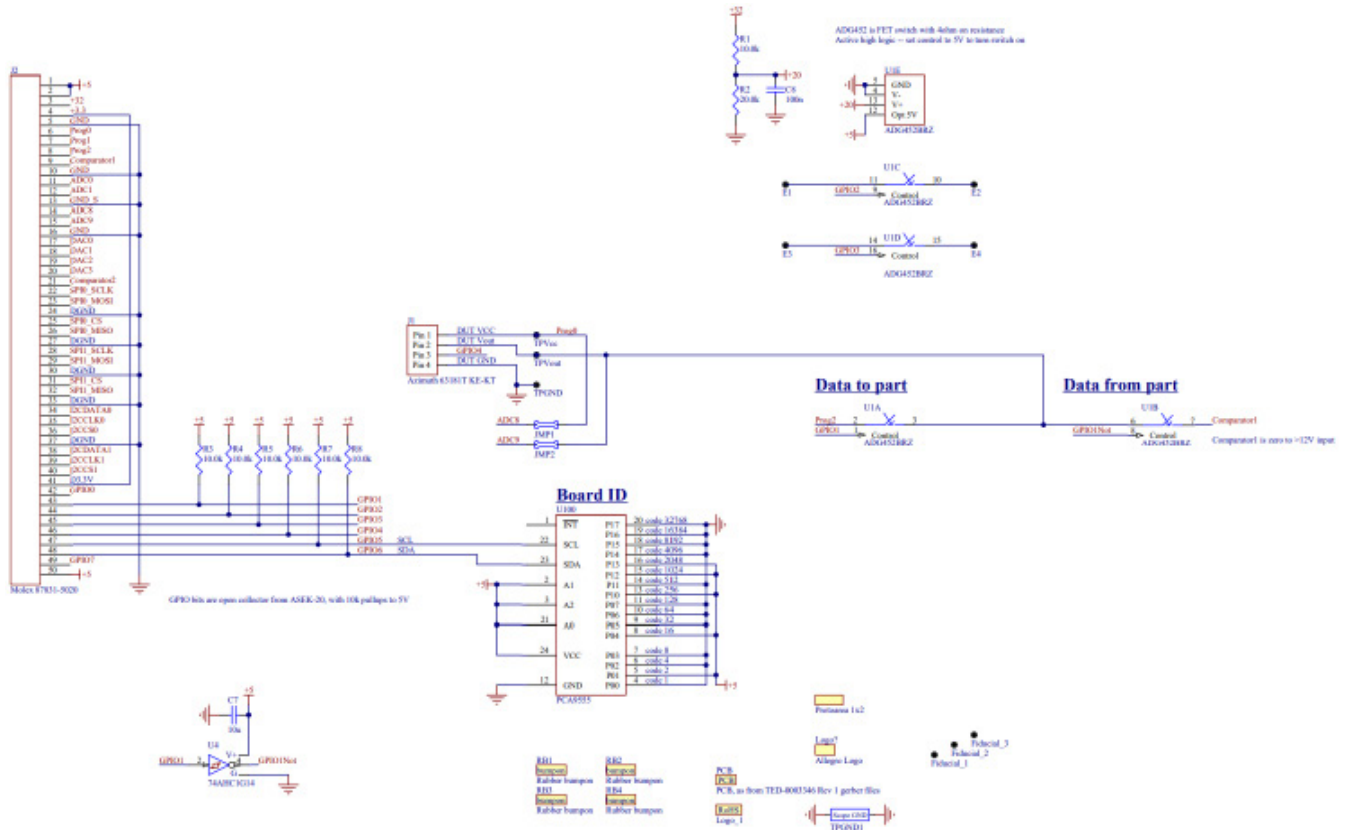

Figure 30: ASEK7031x Daughterboard Schematic