



TAOGLAS®



Datasheet

Active GNSS Surface Mount Patch

Part No:
ASGPDF254.A

Description

GPS/GLONASS/BeiDou/Galileo SMD Dual Feed Active Patch with Embedded Active Circuitry

Features:

Embedded Dual-Feed Patch for Lowest Axial Ratio

Covers Bands:

- GPS L1C
- GLONASS L1
- Galileo E1
- BeiDou B1

SMD Antenna – No Cable and Connector Required

Dimension: 25*25*6.5mm

Designed for a 70x70mm Ground plane

RoHS & Reach Compliant

1.	Introduction	2
2.	Specification	3
3.	Antenna Characteristics	5
4.	Radiation Patterns	11
5.	LNA Characteristics	15
6.	Mechanical Drawing	17
7.	Antenna Integration Guide	18
8.	Packaging	24
9.	Solder Reflow Profile	26
<hr/>		
	Changelog	27

Taoglas makes no warranties based on the accuracy or completeness of the contents of this document and reserves the right to make changes to specifications and product descriptions at any time without notice. Taoglas reserves all rights to this document and the information contained herein. Reproduction, use or disclosure to third parties without express permission is strictly prohibited.



1. Introduction



The Taoglas ASGPDF254.A is a single band active GNSS patch covering GPS/GLONASS/BeiDou/Galileo. The ASGPDF254.A has been designed with a dual pin patch to enhance performance by improving multipath rejection so signals can be received and sent more clearly.

With hidden active circuitry embedded between the ceramic patch and PCB base, it has been designed to allow the user to mount it directly onto their device PCB. This eliminates the need for using a cable and connector thus speeding up the assembly process by allowing successfully solder surface mount components to a circuit board via the SMD process. The ASGPDF254.A measures 25 x 25 x 6.45mm and is optimized for a ground plane size of 70*70mm being required for operation however smaller ground planes can be used.

The ASGPDF254.A also includes a two-stage LNA and a front-end SAW filter to reduce out of band noise such as from nearby cellular transceivers and this improves the probability of the wireless device passing radiated spurious emissions certification. As with many high performance Taoglas patches, the series is produced in a TS16949 automotive quality approved facility, and each patch produced is 100% tested for gain (S21) and return loss (S11) to ensure total consistency of performance.

Typical Applications Include:

- Wearables
- Asset Tracking
- Navigation Systems

Taoglas also offers custom tuning service based on minimum order quantities, contact your regional Taoglas customer support team for further information.

2. Specification

GNSS Frequency Bands					
GPS	L1 1575.42 MHz	L2 1227.6 MHz	L5 1176.45 MHz		
	■	□	□		
GLONASS	G1 1602 MHz	G2 1248 MHz	G3 1207 MHz		
	■	□	□		
Galileo	E1 1575.24 MHz	E5a 1176.45 MHz	E5b 1201.5 MHz	E6 1278.75 MHz	
	■	□	□	□	
BeiDou	B1C 1575.42 MHz	B1I 1561 MHz	B2a 1176.45 MHz	B2b 1207.14 MHz	B3 1268.52 MHz
	■	■	□	□	□
L-Band	L-Band 1542 MHz				
	■				
QZSS (Regional)	L1 1575.42 MHz	L2C 1227.6 MHz	L5 1176.45 MHz	L6 1278.75e6	
	■	□	□	□	
IRNSS (Regional)	L5 1176.45 MHz				
	□				
SBAS	L1/E1/B1 1575.42 MHz	L5/B2a/E5a 1176.45 MHz	G1 1602 MHz	G2 1248 MHz	G3 1207 MHz
	■	□	■	□	□

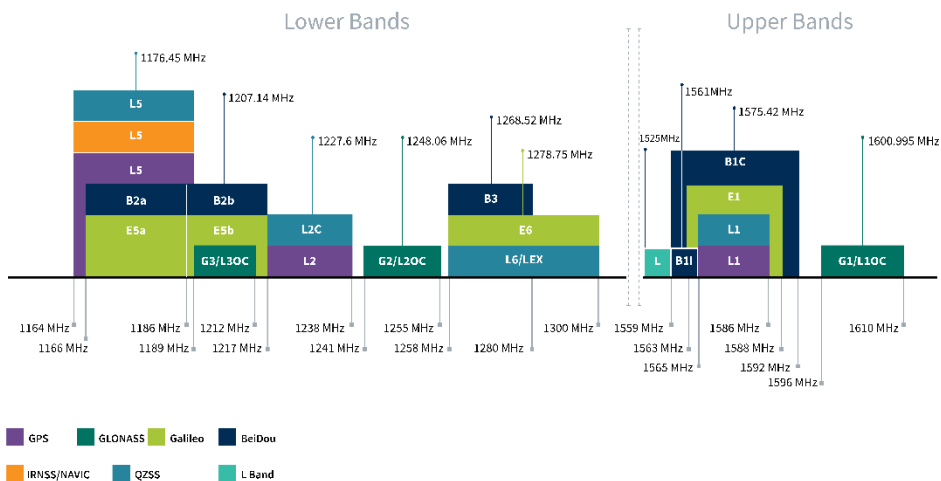

GNSS Bands and Constellations

GNSS Electrical			
Frequency (MHz)	1561	1575.42	1603
Efficiency (%)	30.3	61.8	50.7
Average Gain (dB)	-5.19	-2.09	-2.95
Peak Gain (dBi)	1.23	4.36	3.55
Impedance	50 Ω		
Polarization	Linear		
Radiation Pattern	Directional		

LNA and Filter Electrical Properties			
Frequency (MHz)	1561	1575.42	1602
Return Loss (dB)	<-10	<-10	<-10
Gain @ 3V (dB)	14.3	14.9	13.7
Noise @ 3V (dB)	2.0	1.9	2.0
DC Power Input (V)	1.8 ~ 5.5		
Power consumption @3V (mA)	4.5		
Outer Band Attenuation (dB)	> 60 @ 617-960 MHz > 50 @ 1,710-2,170 MHz		

Mechanical	
Ceramic Dimension (mm)	25 x 25 x 6.4
Weight (g)	--
Material	Ceramic

Environmental	
Operation Temperature	-40°C to 85°C
Humidity	Non-condensing 65°C 95% RH
Moisture Sensitivity Level (MSL)	3 (168 Hours)

* Antenna properties were measured with the antenna mounted on 70*70mm Ground Plane.

3. Antenna Characteristics

3.1 S11 / VSWR / Return Loss Test Setup

AUT



Vector Network Analyzer

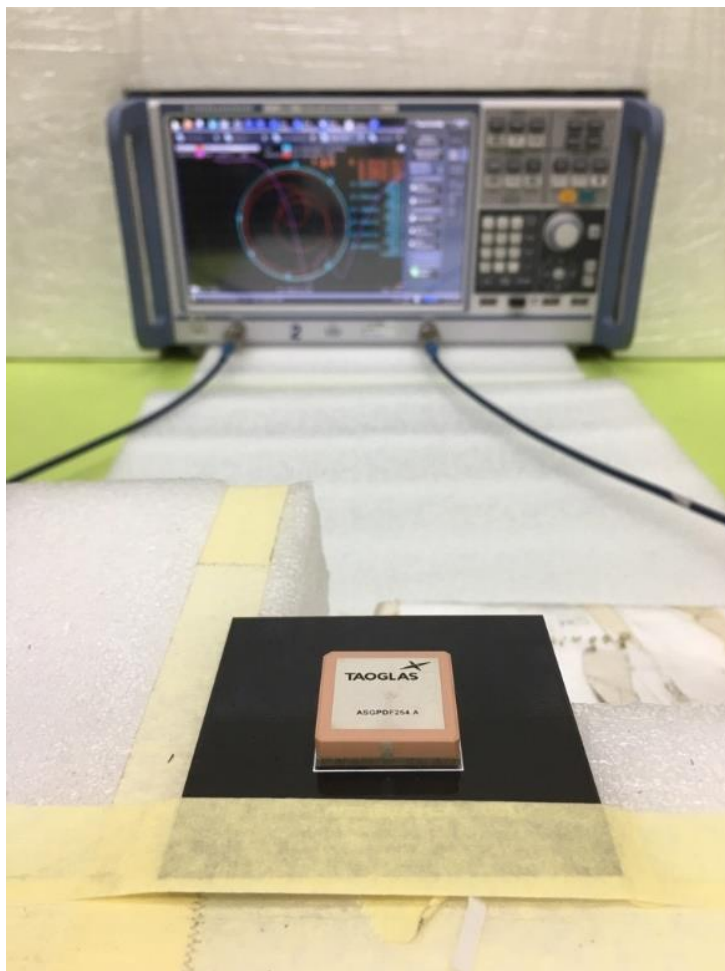

3.2 Return Loss

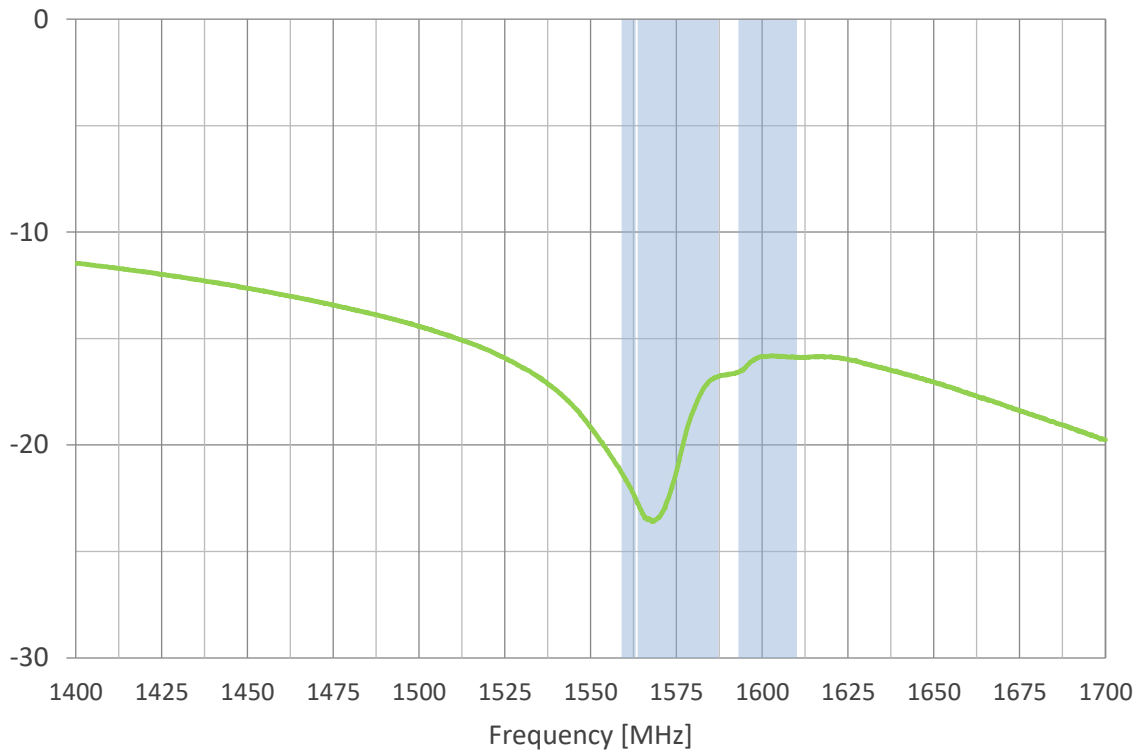

3.3 VSWR

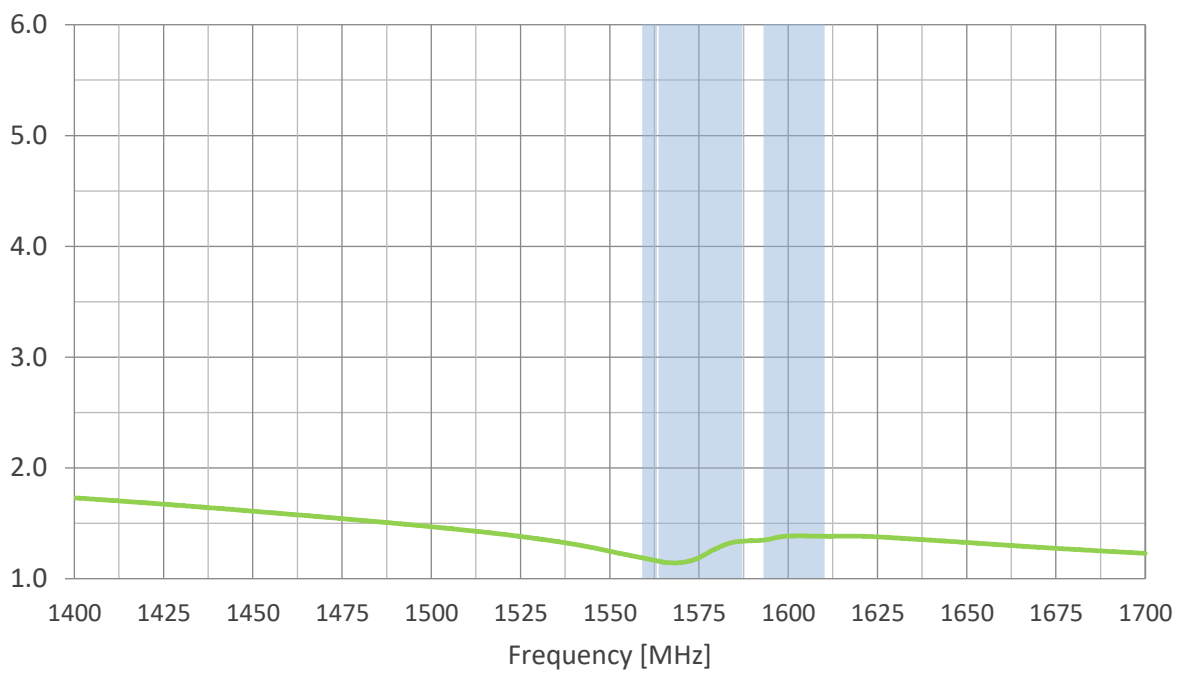

3.4 Efficiency

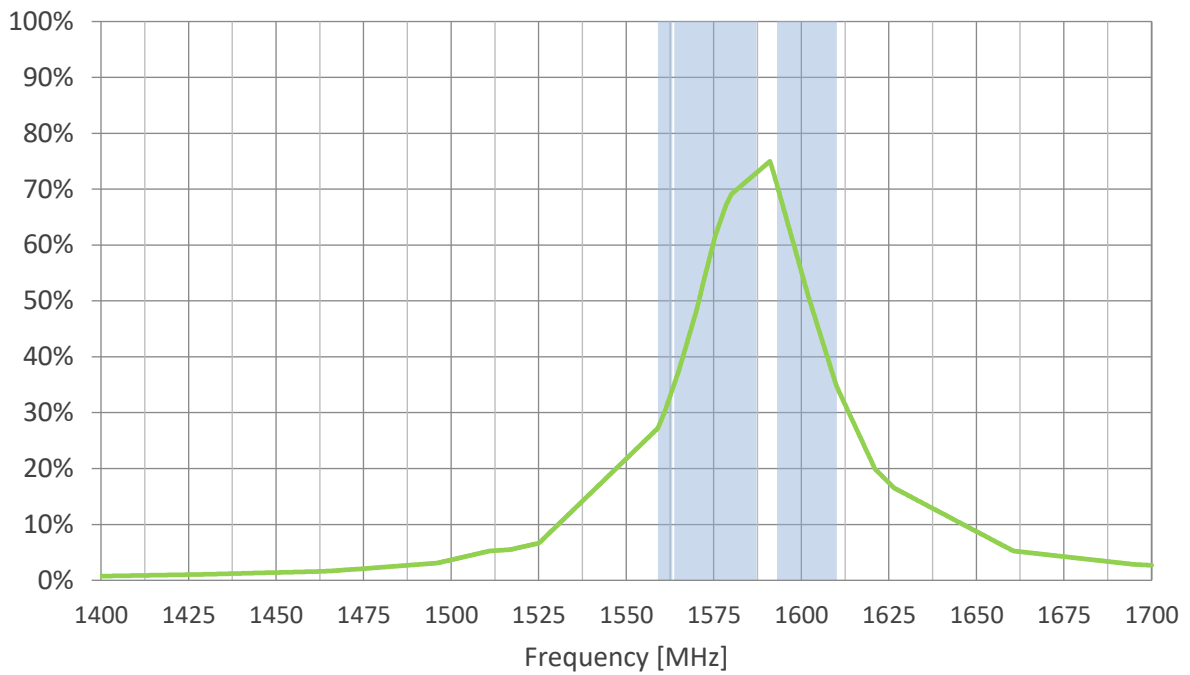

3.5 Average Gain

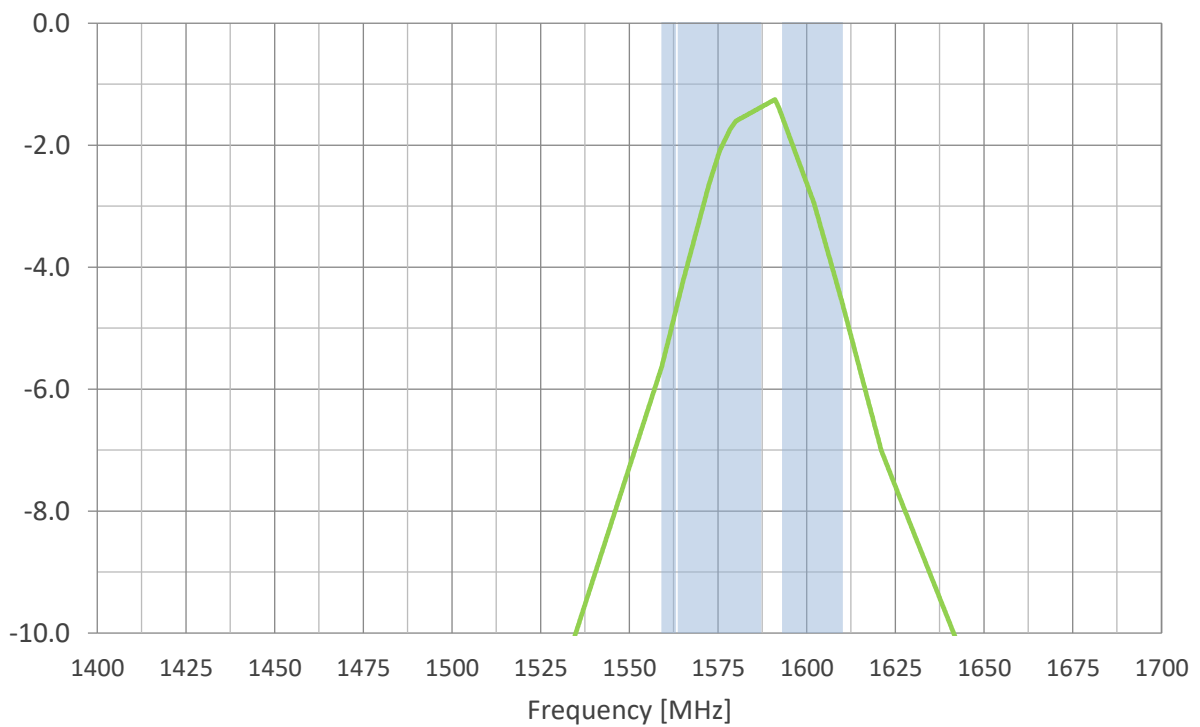

3.6 Peak Gain

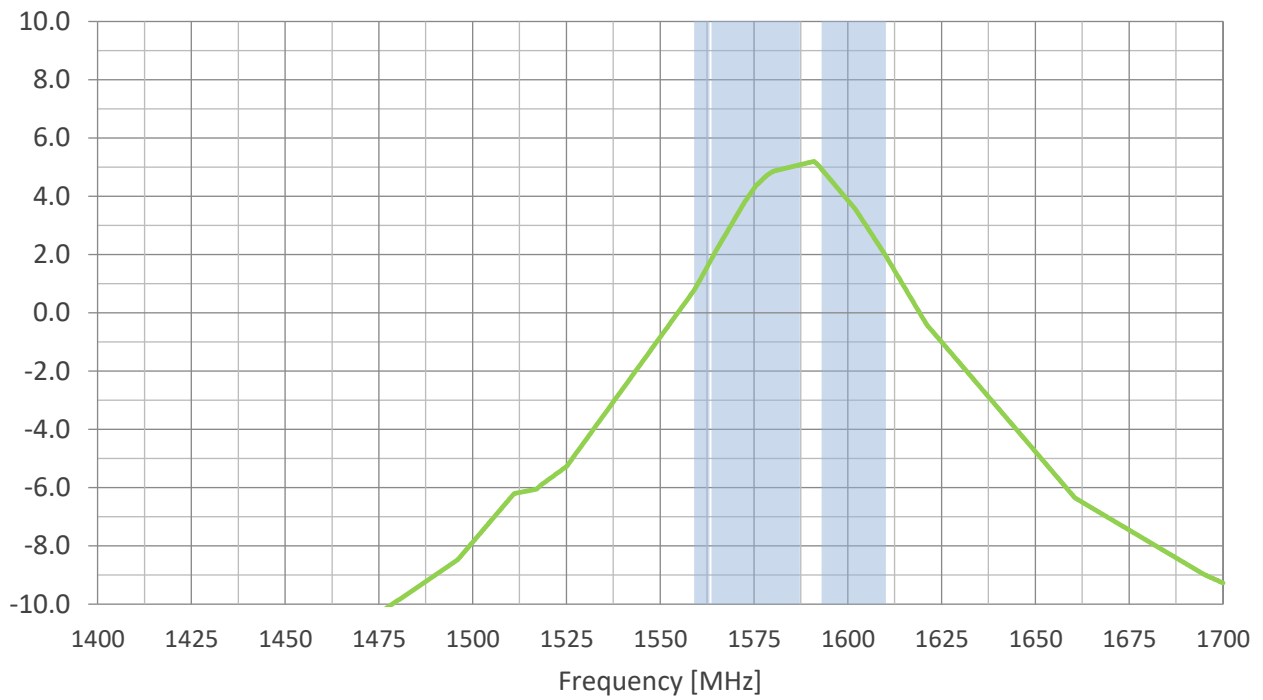

3.7 Axial Ratio vs Frequency

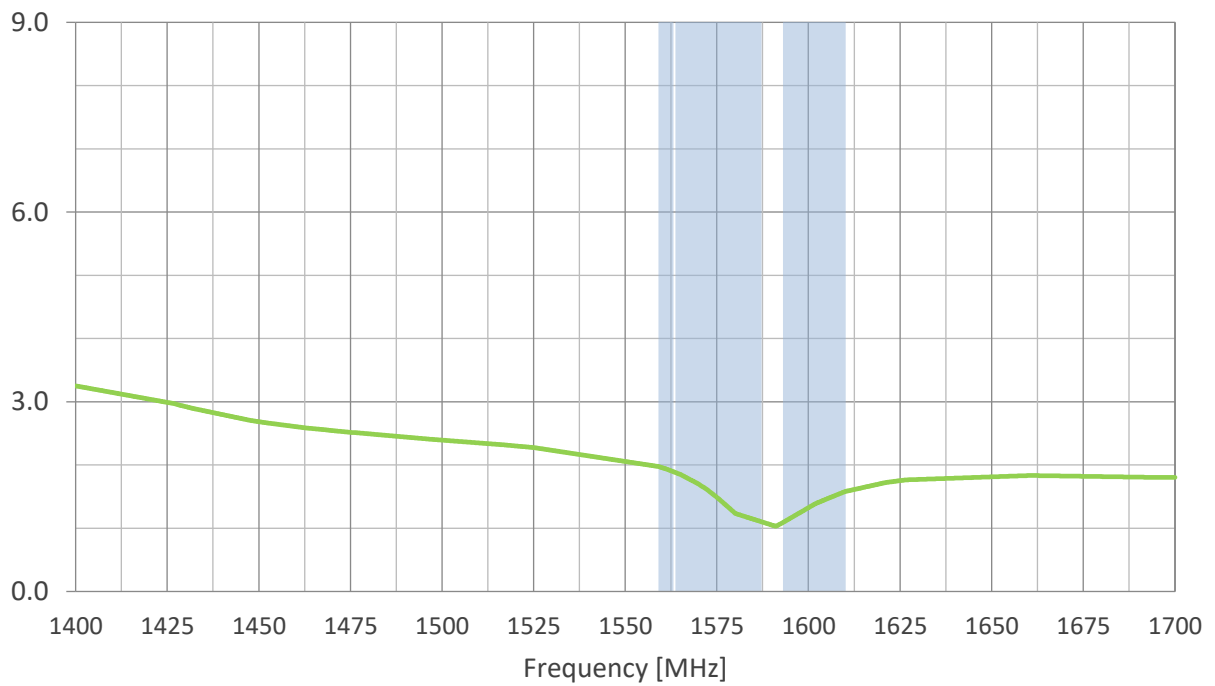

3.8 Axial Ratio @1561MHz

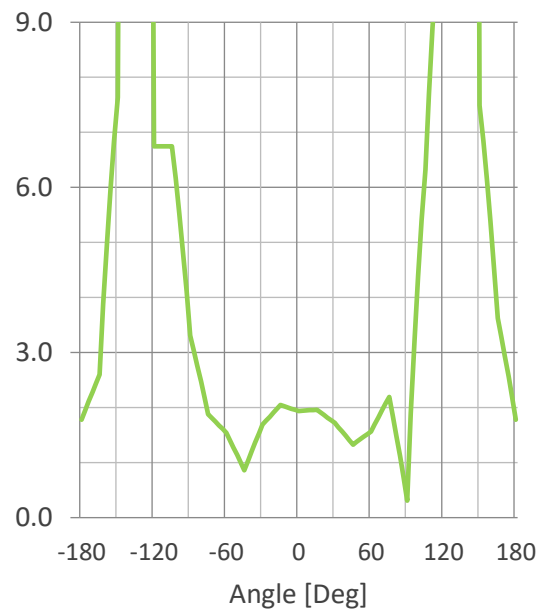
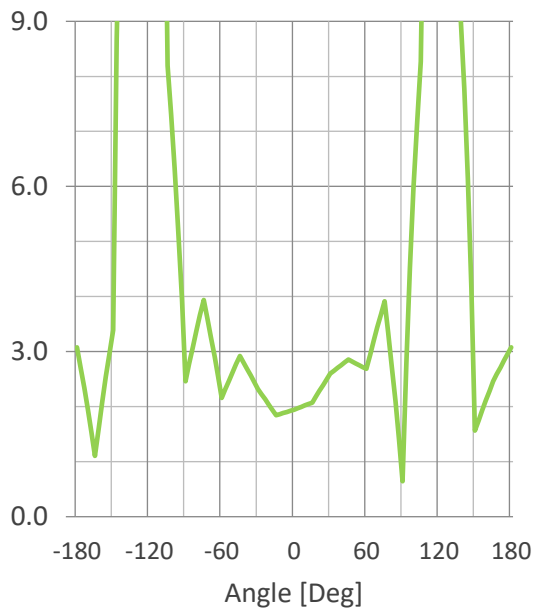

3.9 Axial Ratio @1575MHz

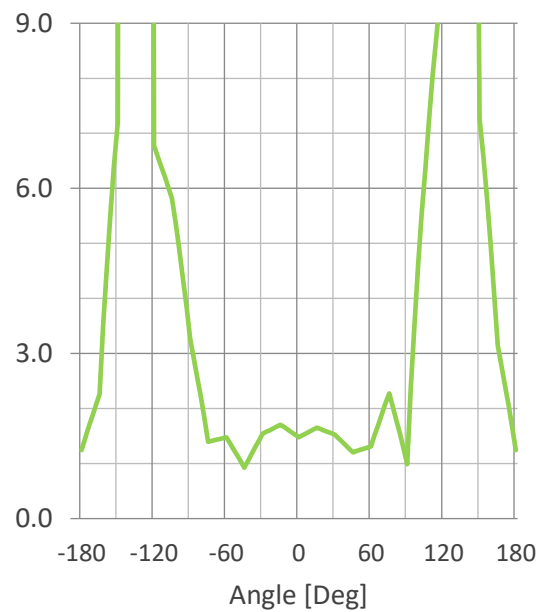
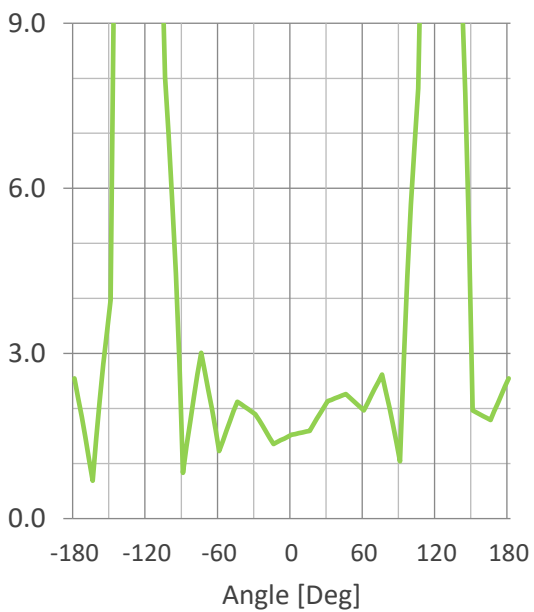

3.10 Axial Ratio @1602MHz

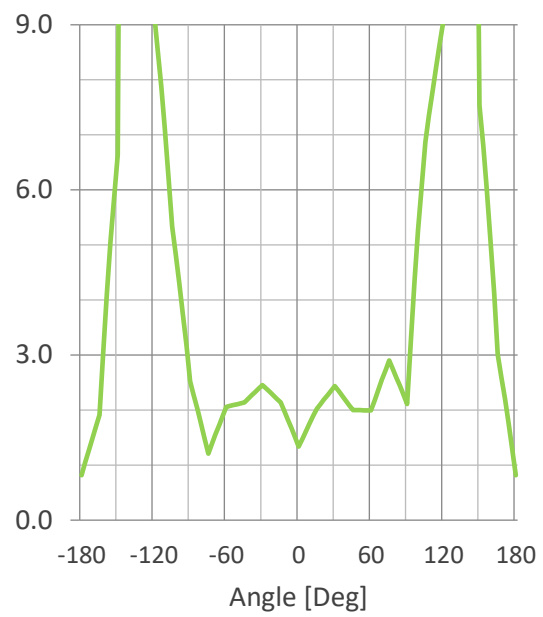
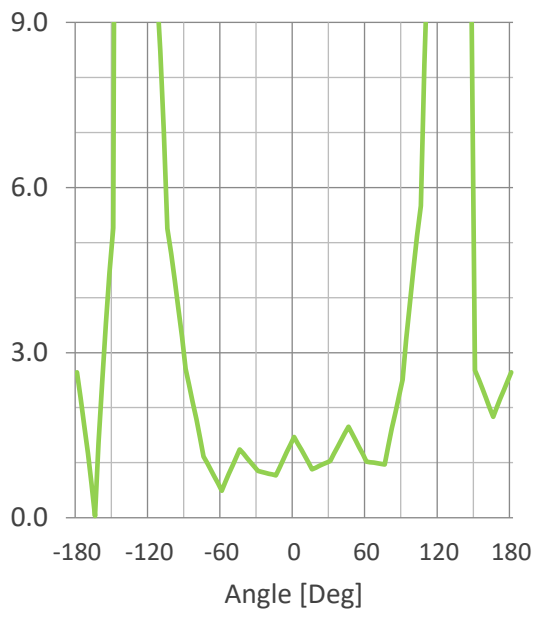

4. Radiation Patterns

4.1 Test Setup

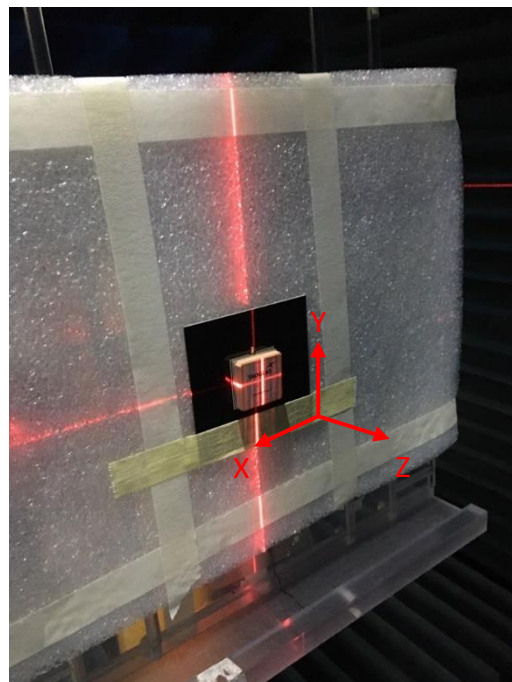
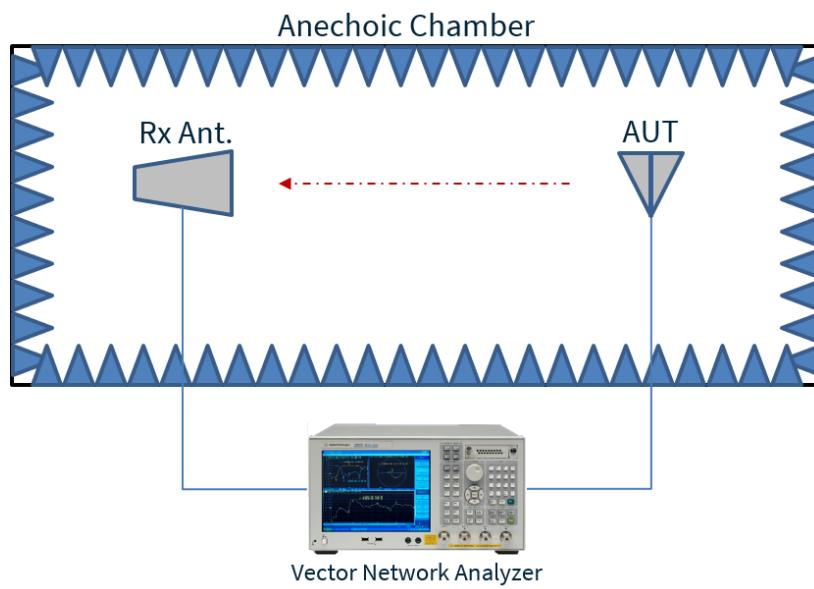

4.2 Radiation Patterns @1561MHz

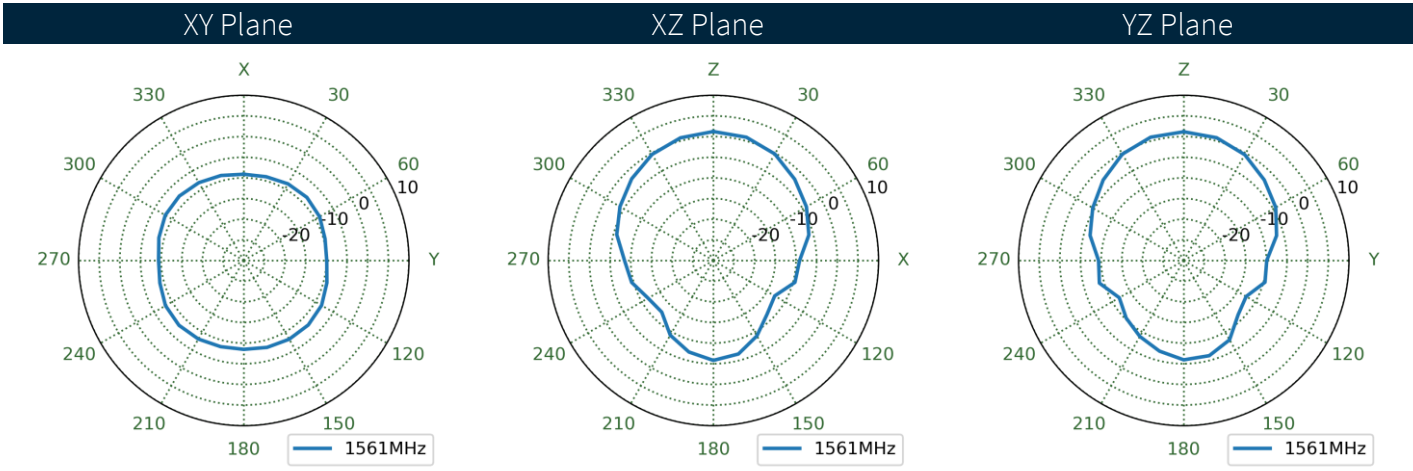
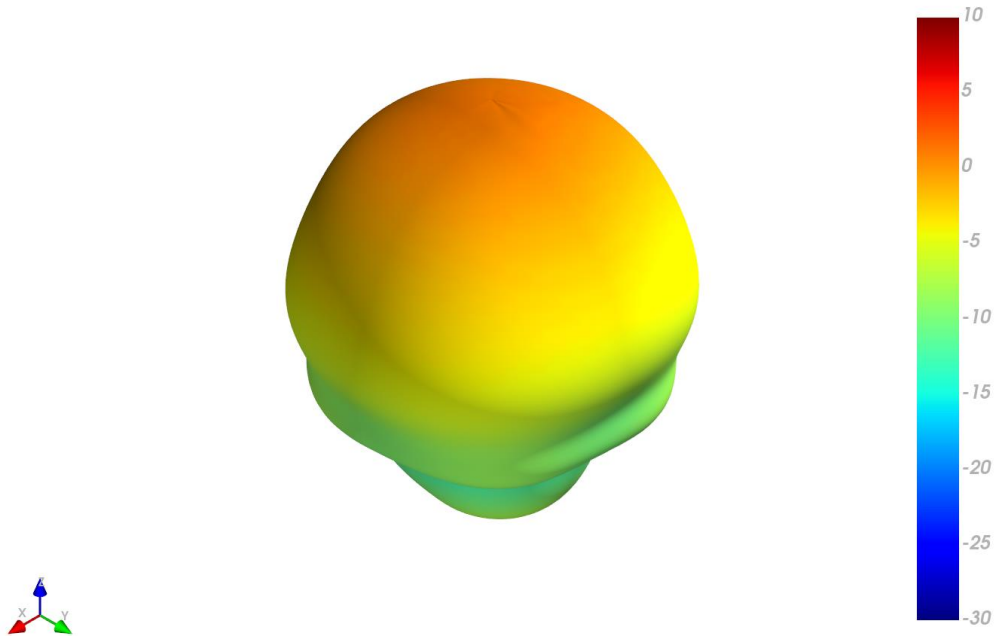

4.3 Radiation Patterns @1575MHz

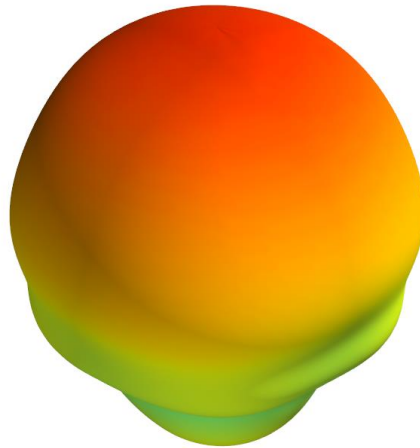

XY Plane XZ Plane YZ Plane

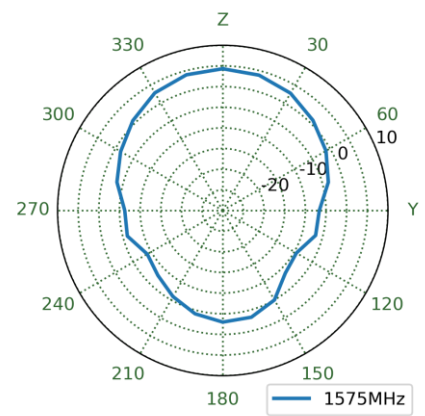
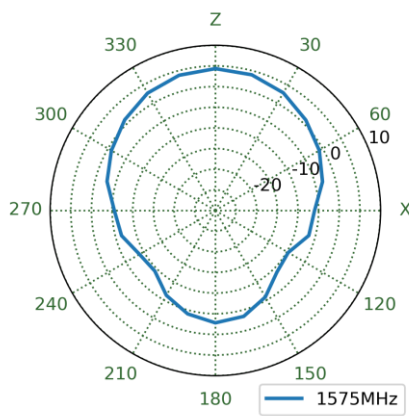
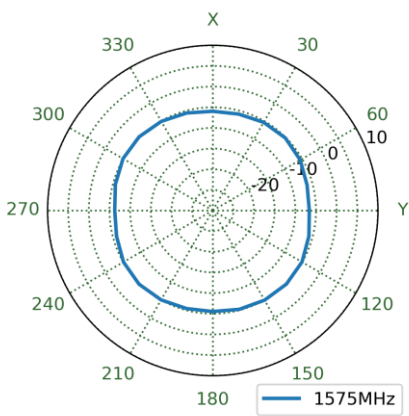

4.4 Radiation Patterns @1602MHz

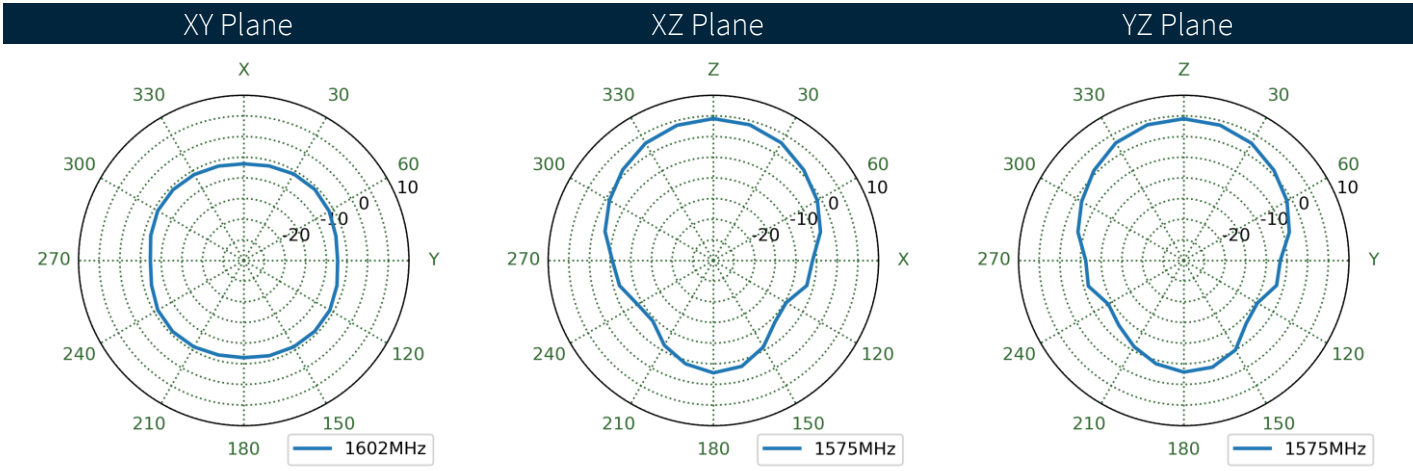
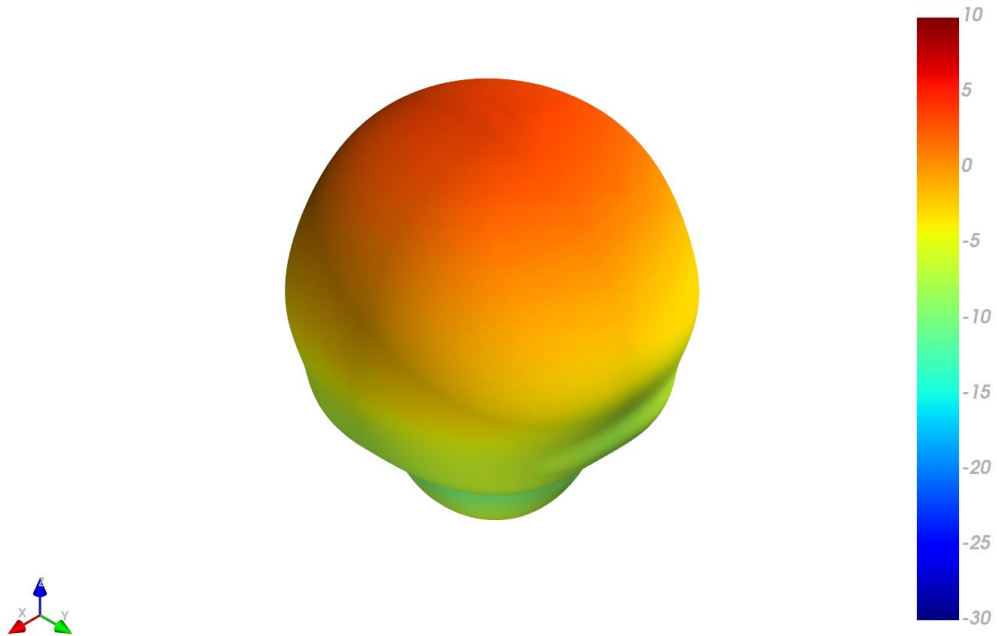

5. LNA Characteristics

5.1 LNA Block Diagram

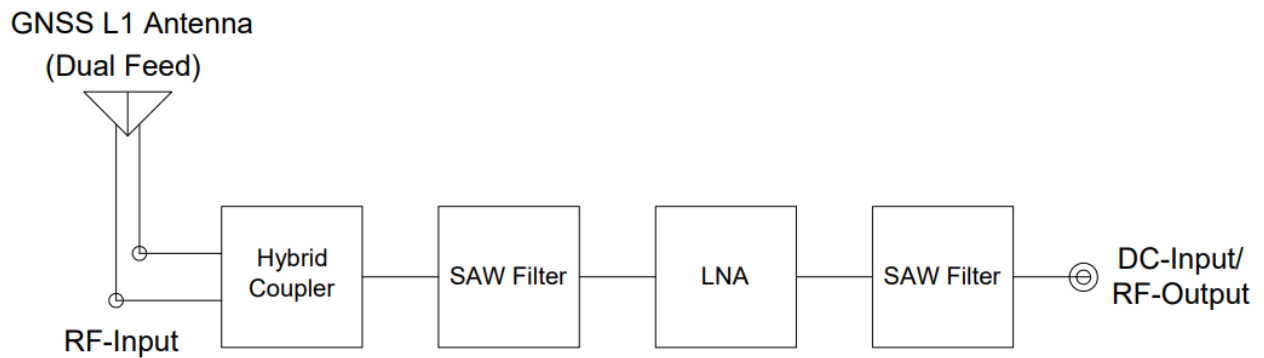

5.2 Gain

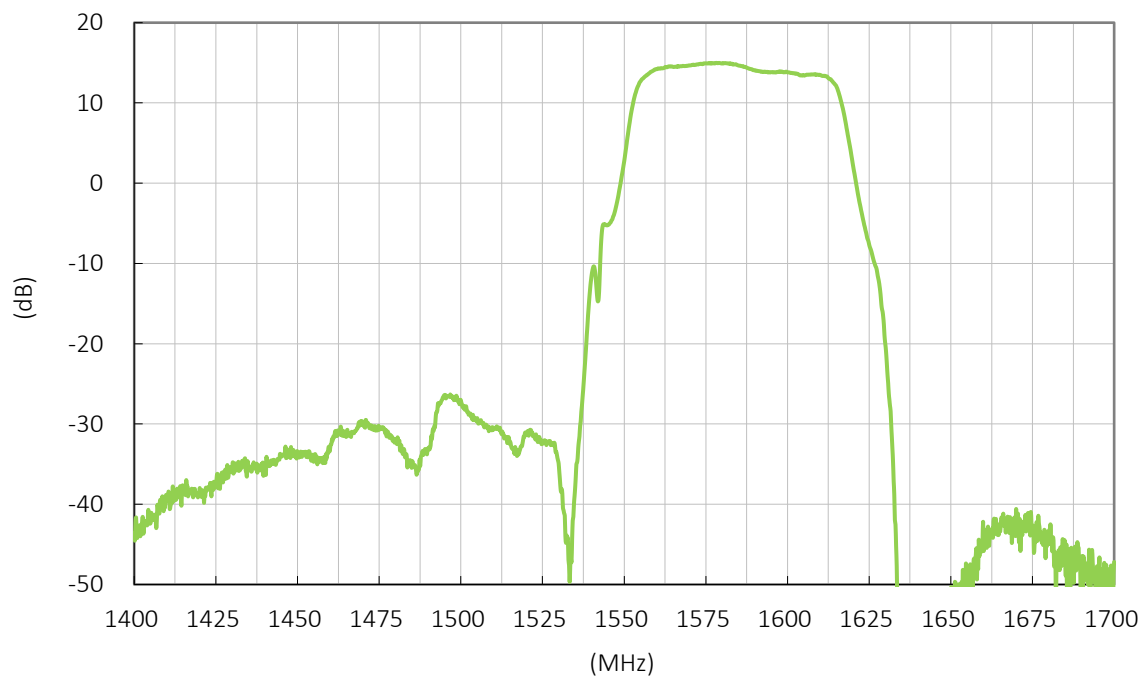

5.3 Noise Figure

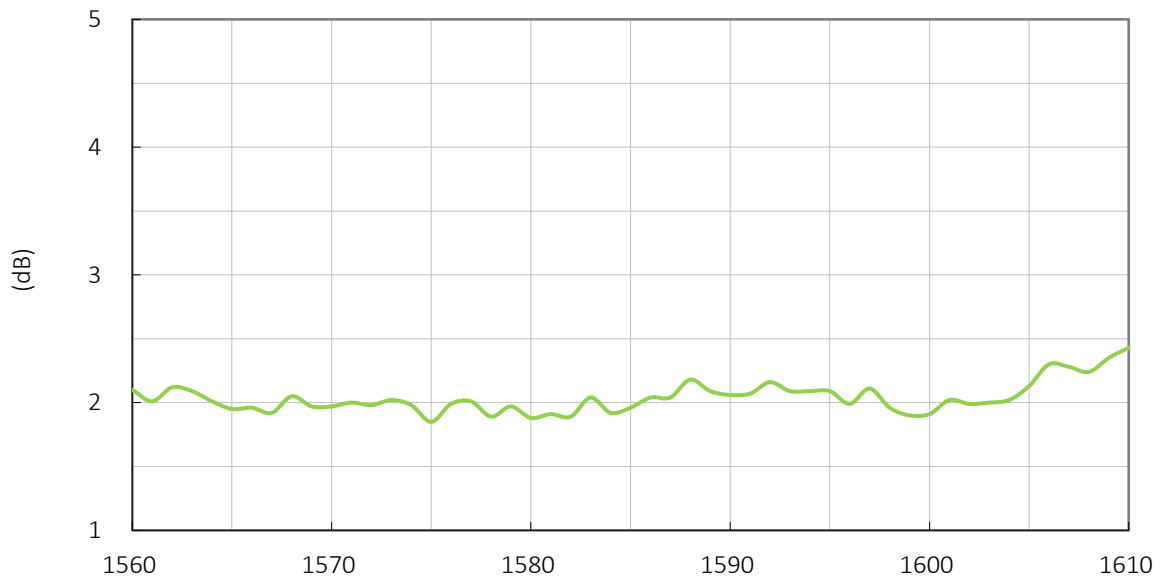

5.4 Out-Of-Band Rejection

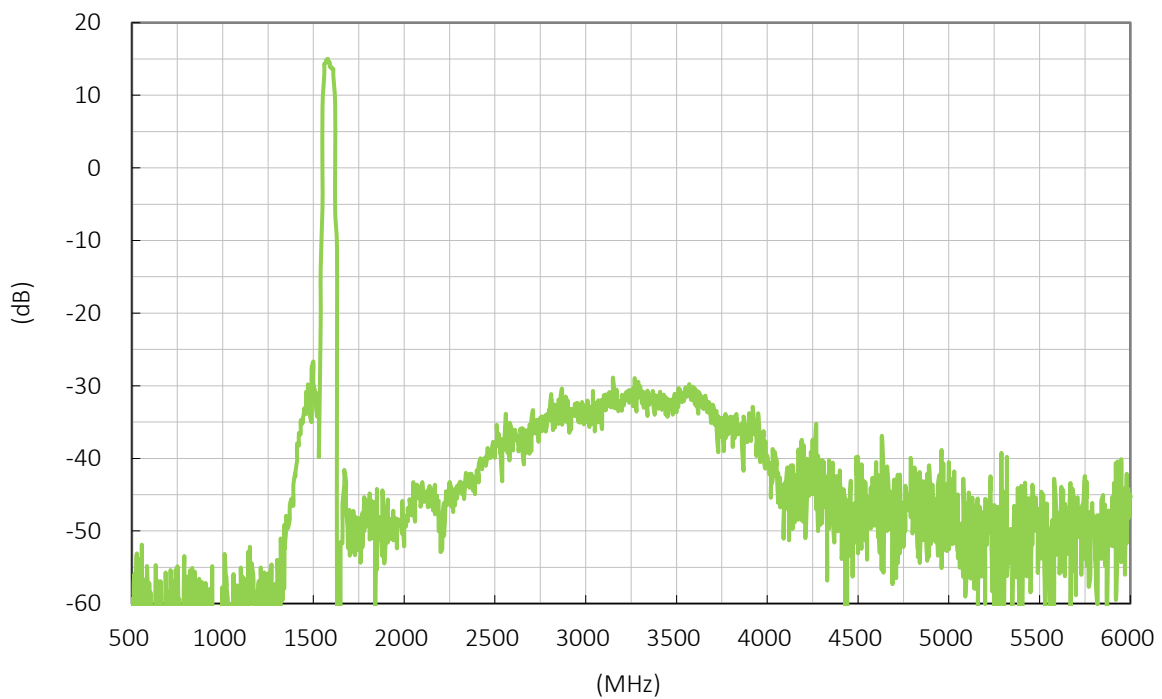

6. Mechanical Drawing

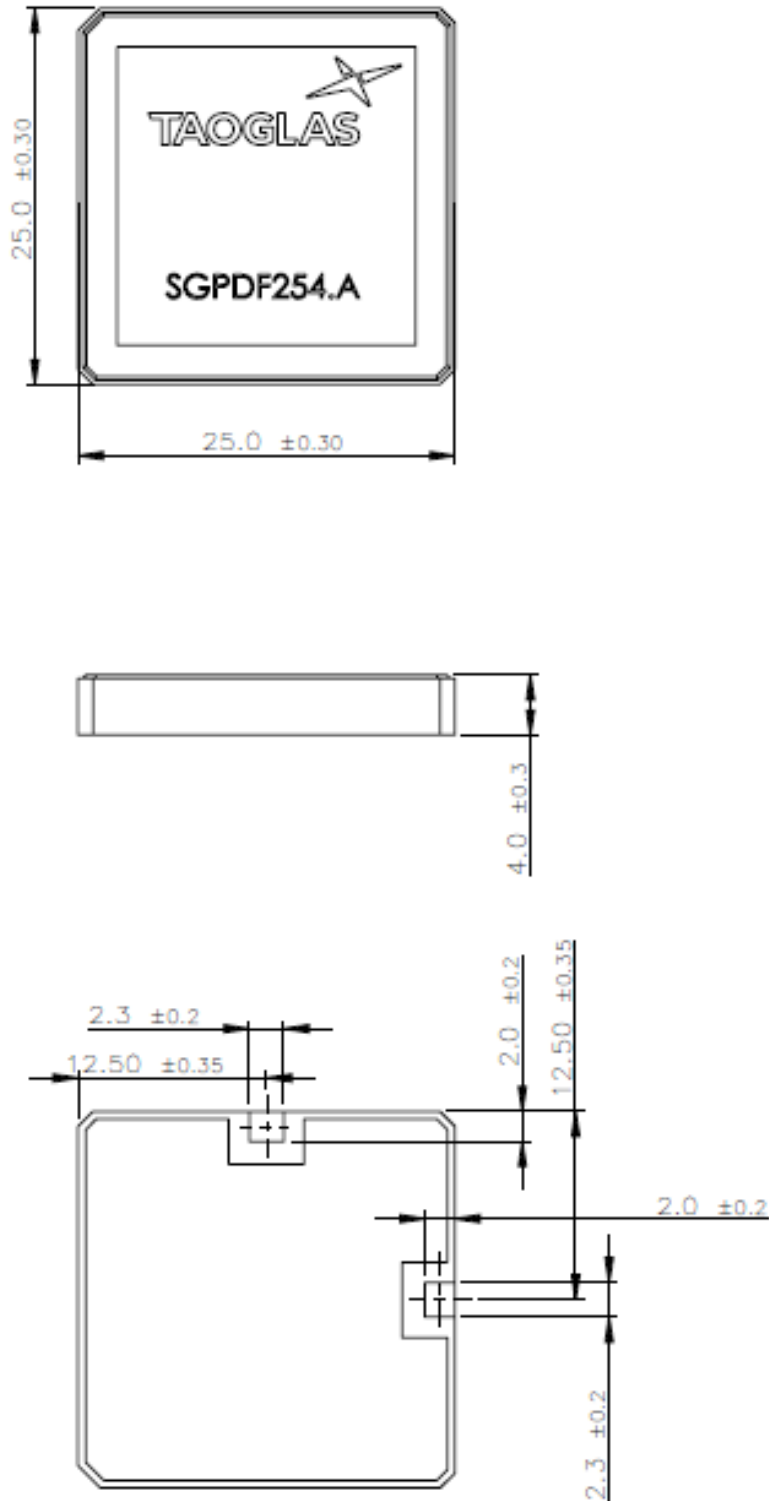

7. Antenna Integration Guide



7.1 Schematic Symbol and Pin Definition

The circuit symbol for the antenna is shown below. The antenna has 9 pins as indicated below. Pin 1 represents the GNSS frequency bands at 1559- 1610MHz.

Pin	Description
1	RF Feed
2-9	Ground

TAOGLAS_ASGPDF254.A
ANT1

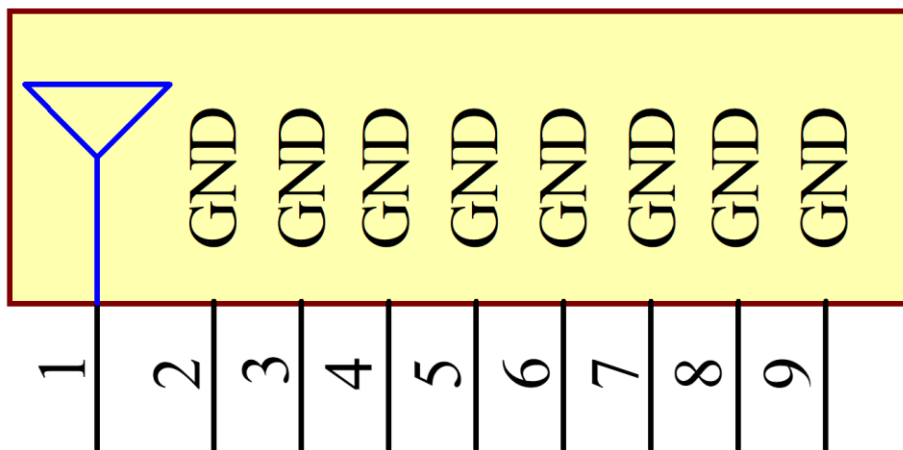

7.2 Antenna Integration

The antenna should be placed at the center of the ground plane with a length and width of 70mm. Maintaining a square symmetric ground plane shape and symmetric environment around the antenna is critical to maintaining the excellent axial ratio and phase center performance shown in this datasheet.



Top Side w/ Solder Mask

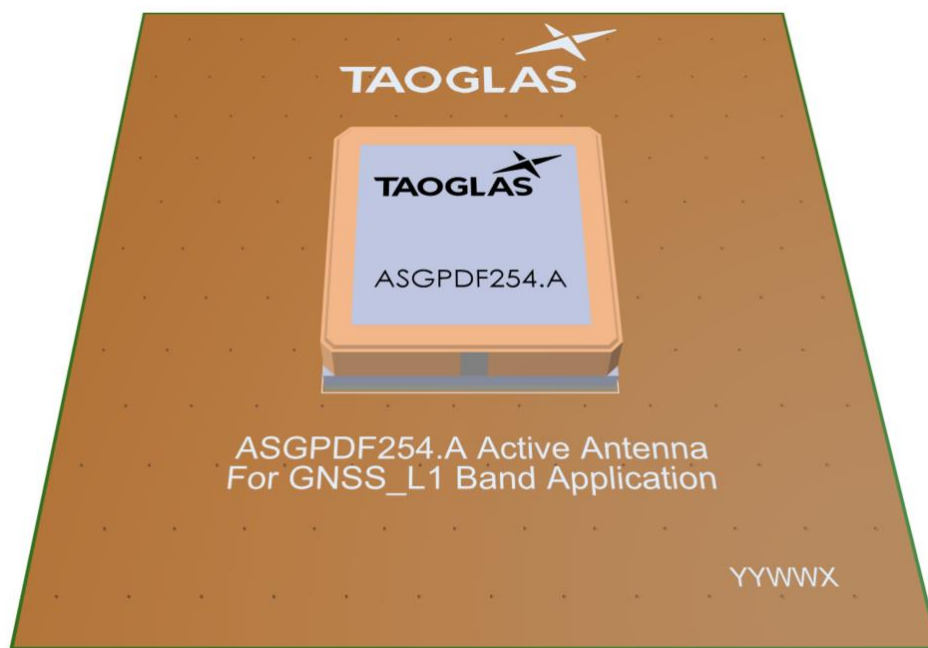

Top Side w/o Solder Mask

7.3 PCB Layout

The footprint and clearance on the PCB must comply with the antenna specification. The PCB layout shown in the diagram below demonstrates the antenna footprint.



Topside

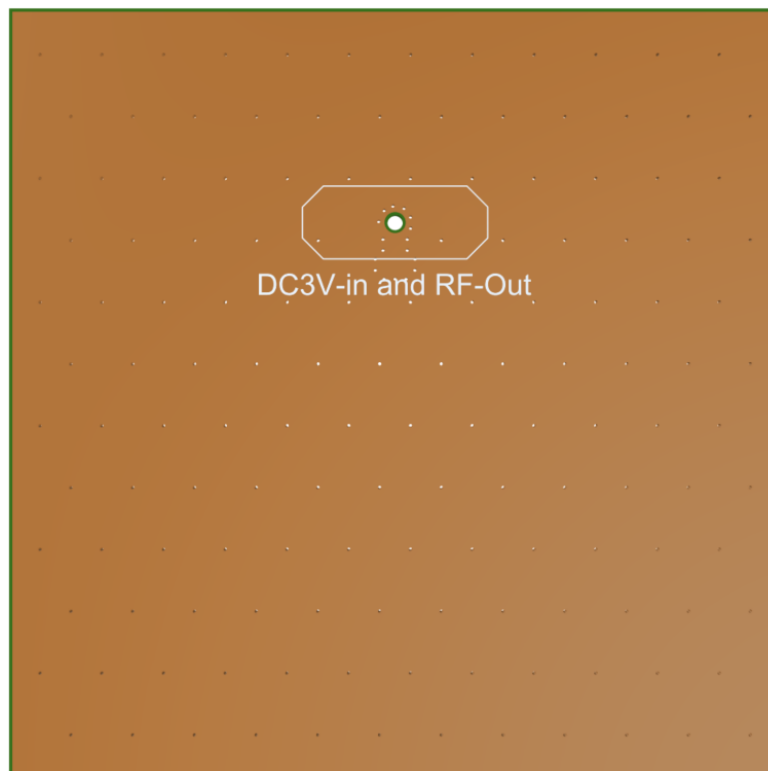

Bottom Side

7.4 Evaluation Board

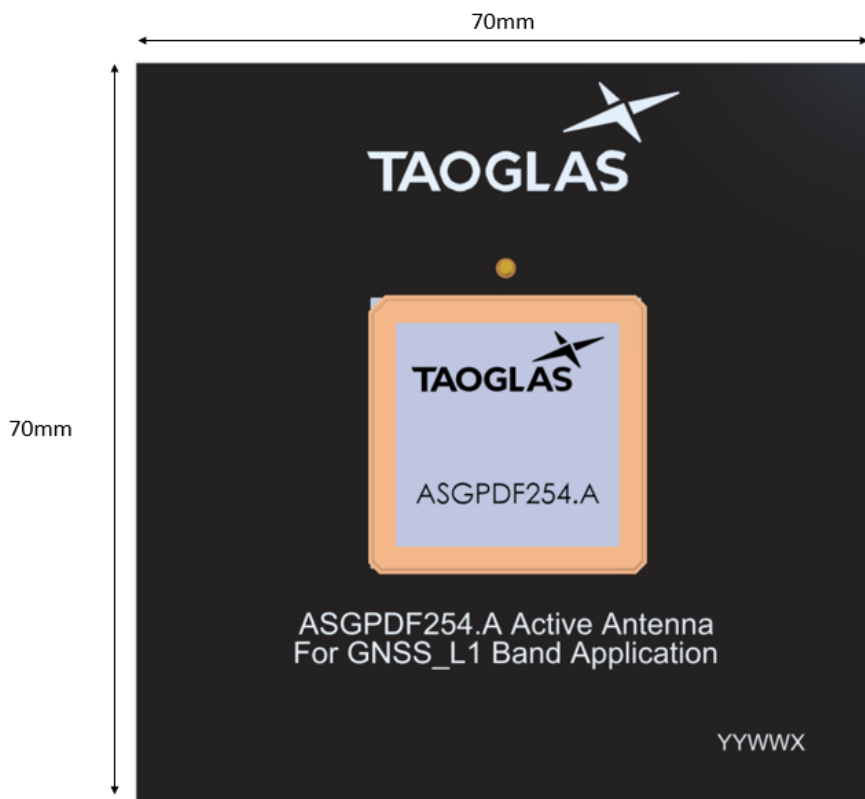

Topside

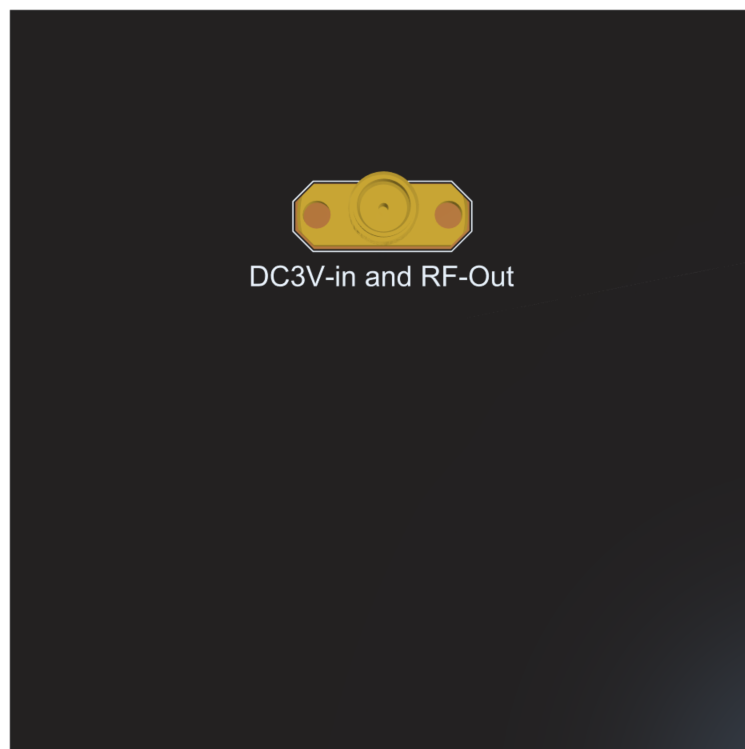

Bottom Side

7.5 Footprint

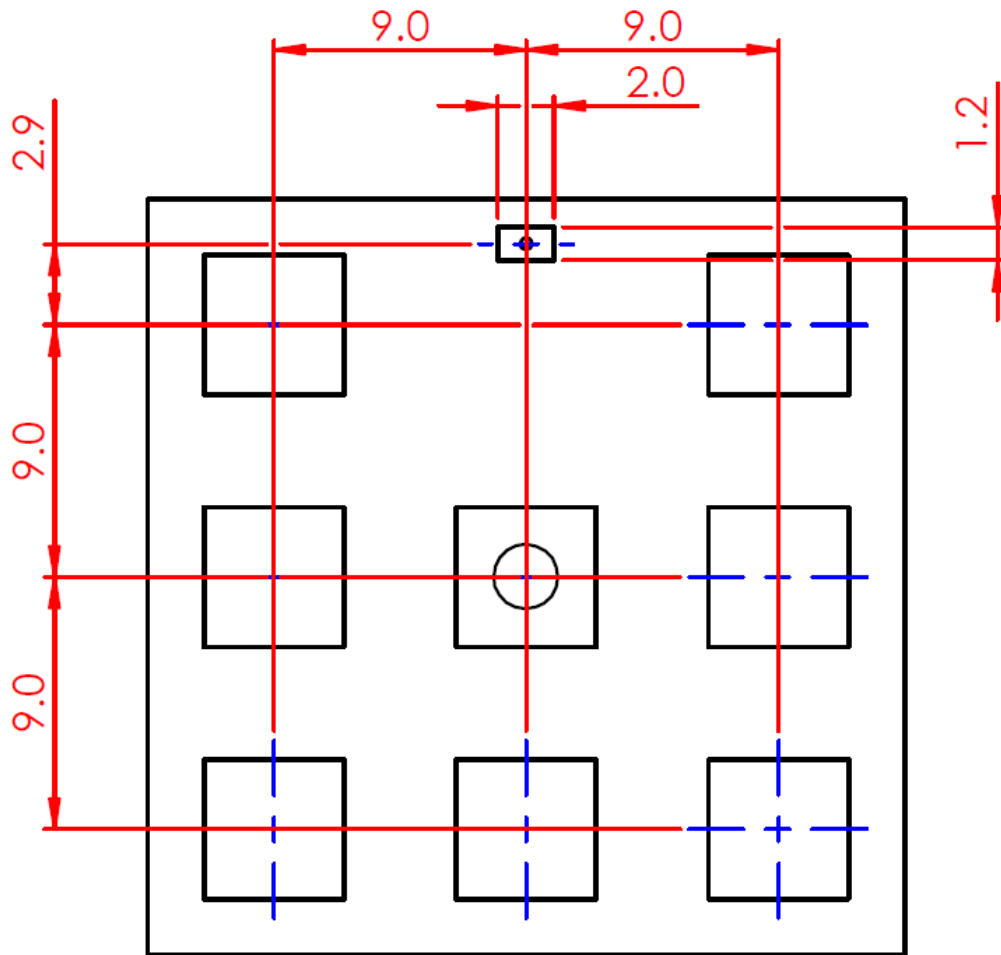

8. Packaging

200 pc ASGPDF254.A per reel
 Dimensions – Ø330*33mm
 Weight – 2.125Kg

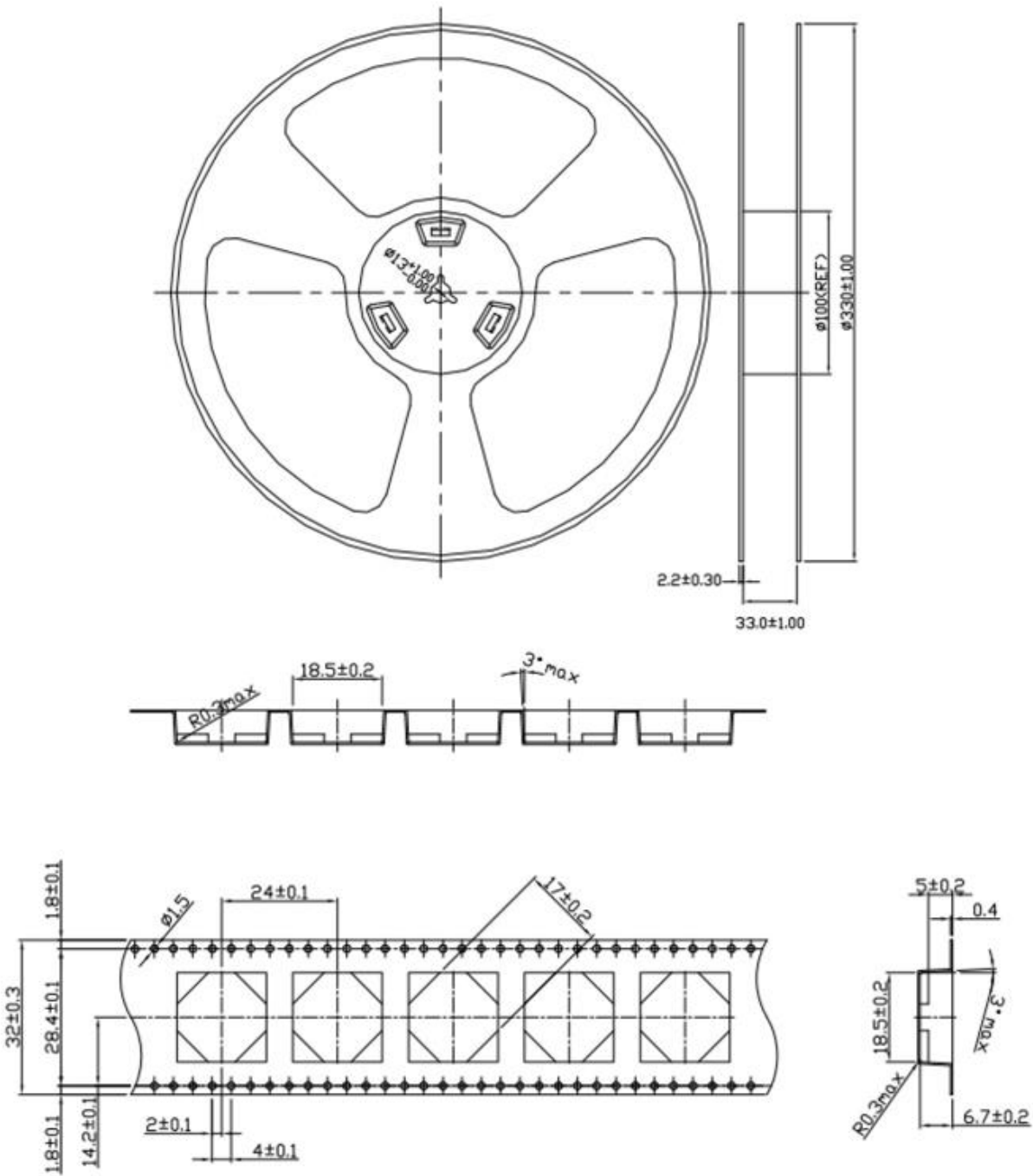

200 pc ASGPDF254.A per small box
Dimensions – 350*340*67mm
Weight – 2.125Kg

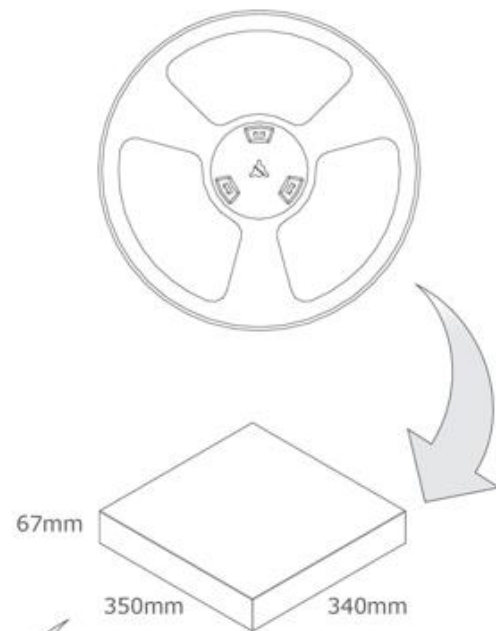

800 pc ASGPDF254.A per carton
Dimensions – 370*360*305mm
Weight – 8.5Kg

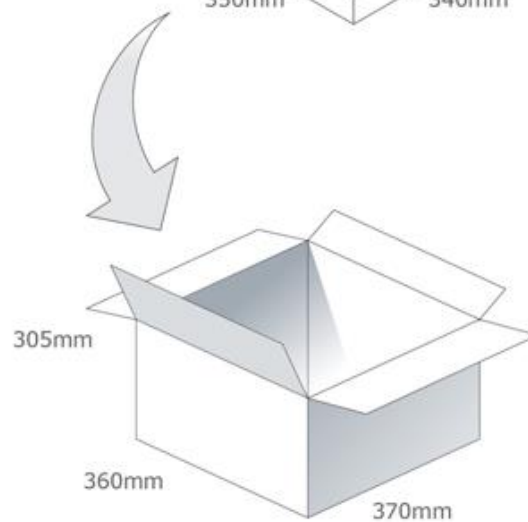

9. Solder Reflow Profile

The ASGPDF254.A can be assembled by following the recommended soldering temperatures are as follows:

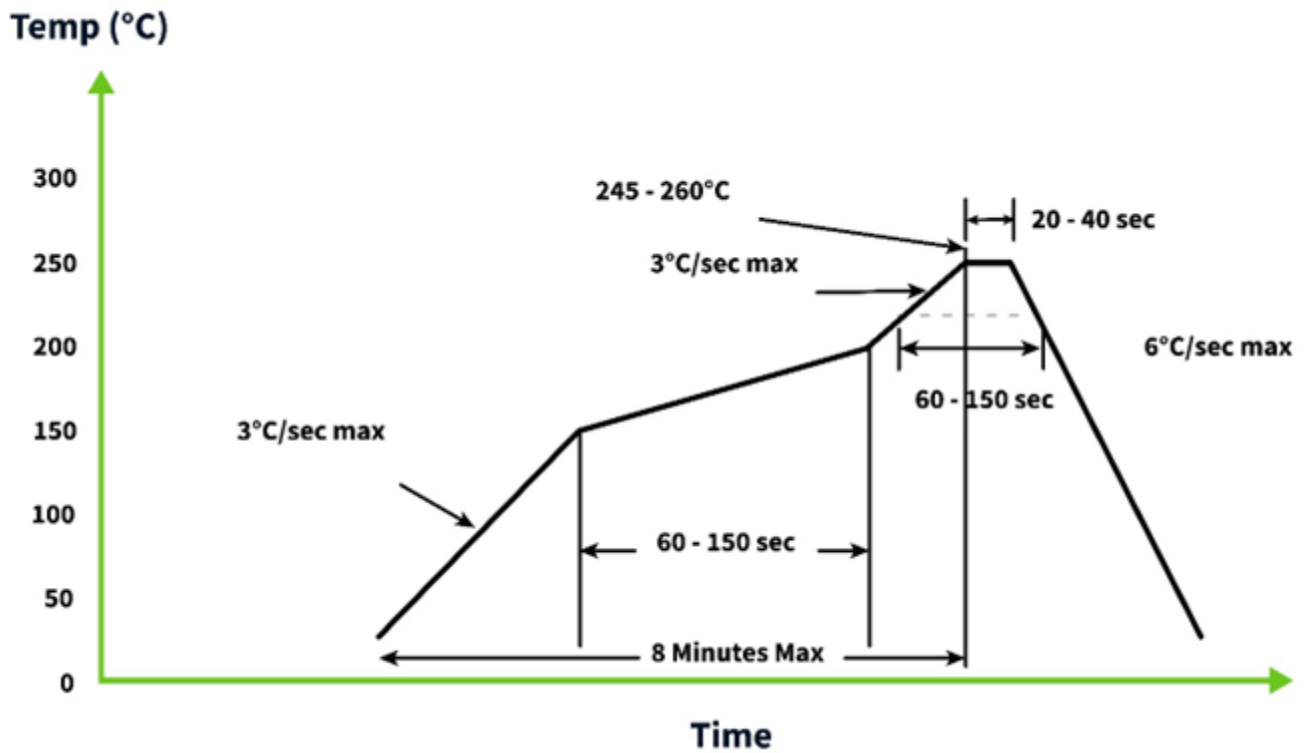

This is not limited to the number of passes through the reflow process. Smaller components are typically mounted on the first pass, however, we do advise mounting the when placing larger components on the board during subsequent reflows.

10. Application Note

The ASGGB254.A performance varies at different ground plane sizes, the results are shown in this section

10.1 VSWR

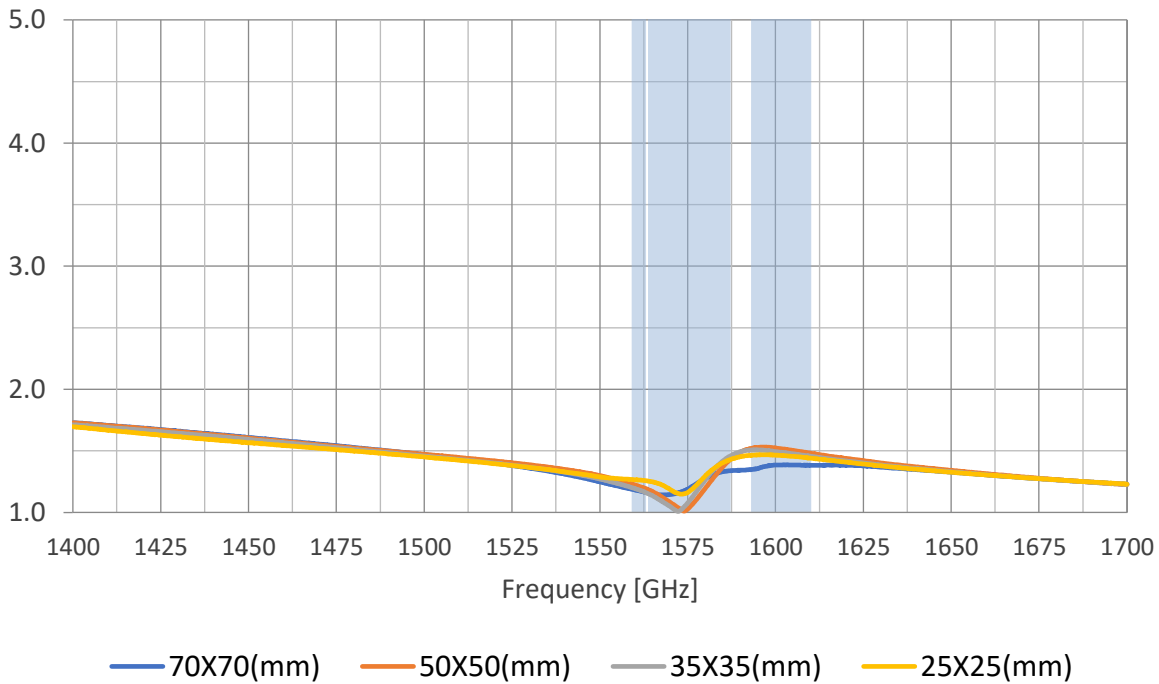

10.2 Efficiency

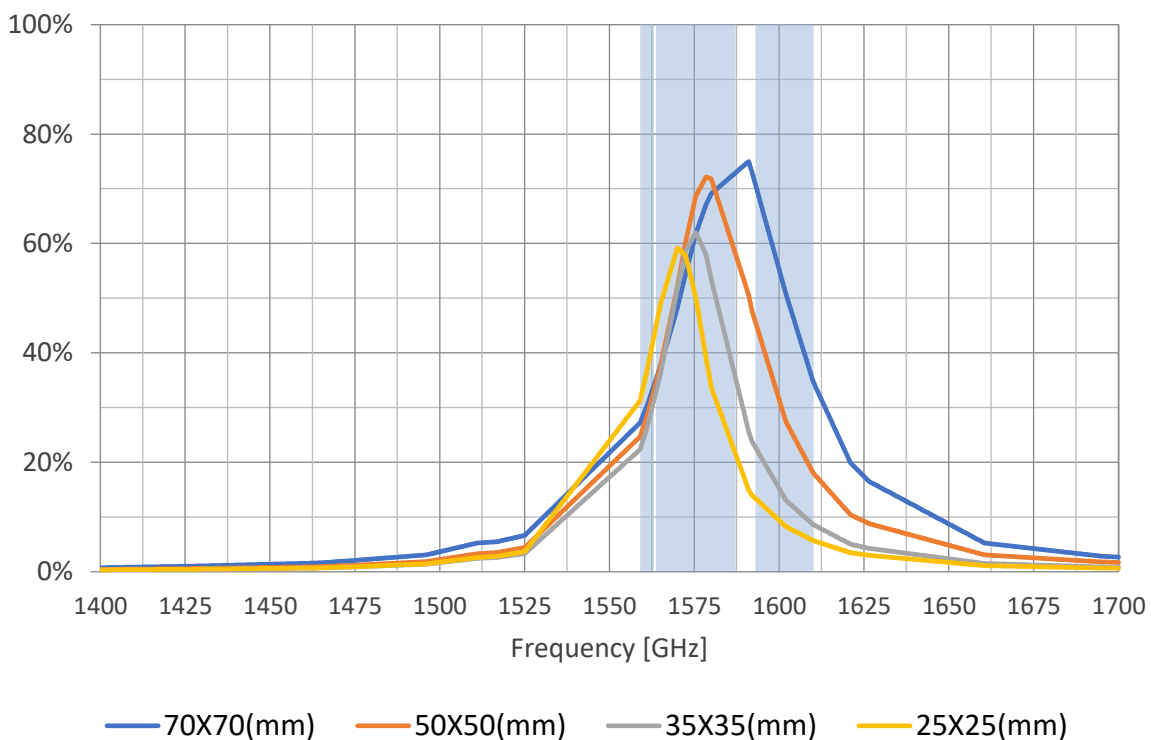

10.3 Peak Gain

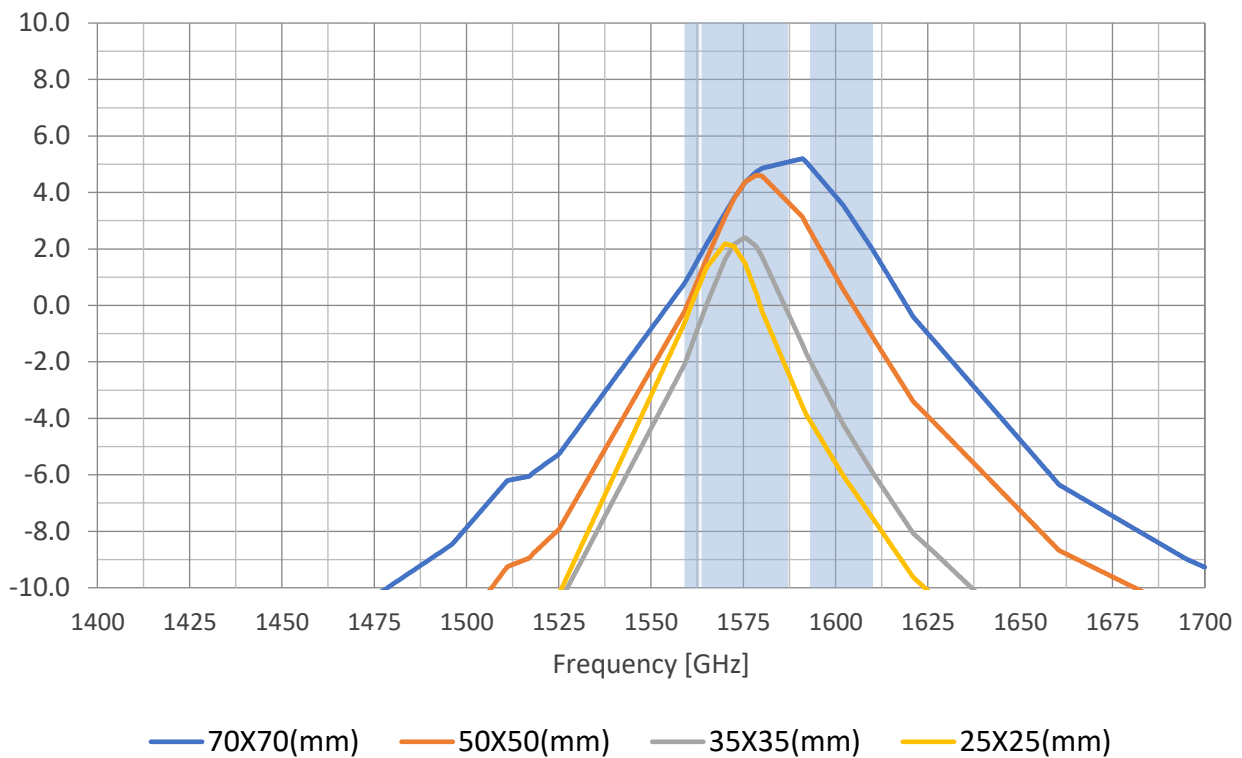

10.4 Efficiency

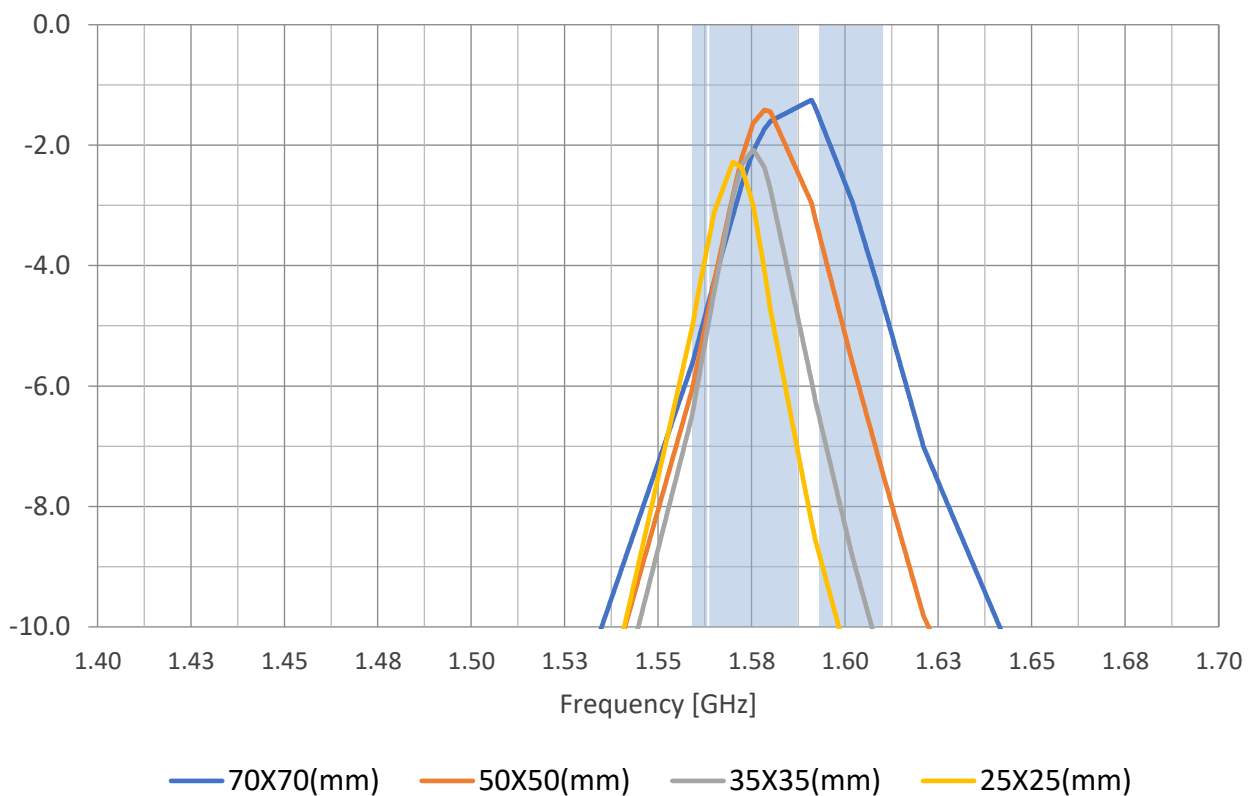

Changelog for the datasheet

SPE-23-8-190- ASGPDF254.A

Revision: A (Original First Release)	
Date:	2023-06-22
Notes:	Initial Release
Author:	Gary West

Previous Revisions
