



ADA compliant sound processor and headset interface for audible and speech communication.

The AudioComm Module is an accessible interface device providing high quality audio output to personal headsets, handsets or assistive hearing devices. It also features voice over USB capability via a headset microphone.

Ideal for use with audible system navigation and voice activated applications, this device delivers clear, two way, audio communications in either high or low ambient noise conditions.

It is robust and weather sealed for use in exposed public environments. Integral illumination of the headset jack socket and sound volume controls assist users with partial sight to locate the AudioComm Module. Embossed symbols (idents) make tactile

location and identification of the headset jack socket and volume controls easier for blind users. Control switches are designed to enable operation with headsticks and other assistive styli.

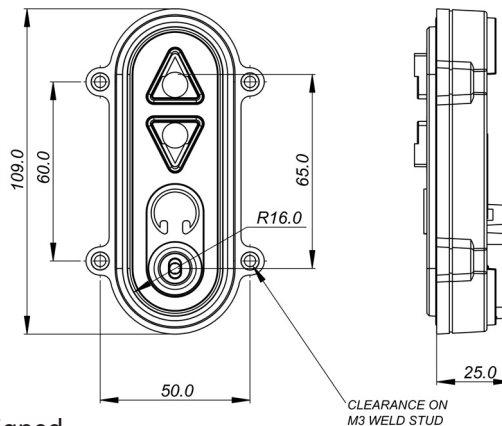

- USB key-press codes can be changed or re-assigned using the Device Utility Software and API (available for download at storm-interface.com).
- Default illumination status and device 'wake-up' behaviour can be configured via the Device Utility Software and API.
- Intensity of the integral backlighting can be adjusted or turned off when not in use via the Device Utility Software and API.
- Headset connection is detected via a tip switch located in the jack plug socket.
- Weather resistant construction for outdoor use.
- Impact and abuse resistant.
- The AudioComm Module is connected to the host system via a single USB cable (supplied separately). No additional drivers required.

Storm Assistive Technology Products provide improved system accessibility for those with impaired vision, restricted mobility, limited dexterity or reading difficulties.



Performance

Vibration & Shock:
Impact Resistance:
Certification:
EMC:

FCC:
ESD Immunity:
EN 301-549 / ADA:

Environmental

Operational Temperature:
Weather Resistance:

Specification

Rating:
Connection:
Audio:

ETSI 5M3
IK09 (10J Rating)
CE / FCC / UL
55032 Class B (Emissions)
55024 (Immunity)
47CFR15 Class B (Emissions)
15kV Contact and Air
Compliant

-20°C to +70°C (dry)
IP65 (when panel mounted)

5V + 0.25V (USB 2.0)
Mini USB B Socket
3.5mm Audio Jack Socket
(Illuminated)

For more information & to order:
www.storm-interface.com

Storm, Storm ATP, Storm Interface, Audio-Comms Module are trademarks of Keymat Technology Ltd. This product includes proprietary technology and intellectual property retained by Keymat Technology Ltd (trading as Storm Interface). All rights reserved.

AT02 Mar 2019
Designed & produced by NIK Design Ltd
www.nikdesign.co.uk

Whilst every effort is made to ensure details are correct at time of print, specifications are subject to change without notice.



FM 37402