

Digital Attenuator 31.5 dB, 6-Bit, TTL Driver, DC-2.0 GHz

Rev. V7

Features

- Attenuation: 0.5 dB Steps to 31.5 dB¹
- Temperature Stability: ± 0.18 dB from -40°C to $+85^{\circ}\text{C}$ Typ.
- Low DC Power Consumption
- Surface Mount Package
- Integral TTL Driver
- High Intercept Point
- Low Cost/High Performance
- Lead-Free CR-13 Package
- 260°C Reflow Compatible
- RoHS* Compliant

Description

M/A-COM's AT20-0107 is a GaAs FET 6-bit digital attenuator with a 0.5 dB minimum step size and a 31.5 dB total attenuation. This attenuator and integral TTL driver is in a ceramic 24-lead surface mount package. The AT20-0107 is ideally suited for use where accuracy, fast speed, very low power consumption and low intermodulation products are required. Typical applications include dynamic range setting in precision receiver circuits and other gain/leveling control circuits. Available with enhanced performance as fully hermetic version. Environmentally screenable as P/N AT-107-PIN.

Ordering Information

Part Number	Package
AT20-0107-PIN	Bulk Packaging
AT20-0107-TR	1000 piece reel
AT20-0107-TB	Sample Test Board

Note: Reference Application Note M513 for reel size information.

Functional Schematic

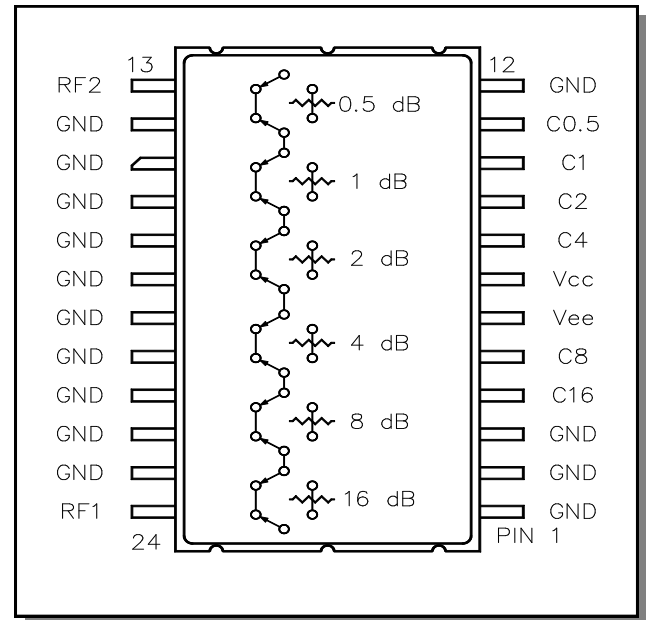

Pin Configuration

Pin No.	Function	Pin No.	Function
1	GND	13	RF2
2	GND	14	GND
3	GND	15	GND
4	C16	16	GND
5	C8	17	GND
6	Vee	18	GND
7	Vcc	19	GND
8	C4	20	GND
9	C2	21	GND
10	C1	22	GND
11	C0.5	23	GND
12	GND	24	RF1

The metal bottom of the case must be connected to RF and DC ground.

¹ * Restrictions on Hazardous Substances, European Union Directive 2002/95/EC.

Digital Attenuator 31.5 dB, 6-Bit, TTL Driver, DC-2.0 GHz

Rev. V7

Electrical Specifications: $T_A = +25^\circ\text{C}^2$

Parameter	Test Conditions	Frequency	Units	Min	Typ	Max
Insertion Loss	—	DC - 2.0 GHz	dB	—	3.2	3.8
Attenuation Accuracy ^{1,3,4}	Any Bit or Combination of Bits	DC - 2.0 GHz	dB	—	—	+ (.3 +7% of atten.) - (.2 +1% of atten.)
VSWR	Full Range	DC - 2.0 GHz	Ratio	—	—	1.8:1
Trise, Tfall Ton, Toff Transients	10% to 90% 50% Control to 90%/10% RF In-band (peak to peak)	— — —	ns ns mV	— — —	50 150 50	— — —
1 dB Compression ⁵	Input Power Input Power	50 MHz 0.5 - 2.0 GHz	dBm dBm	— —	+21 +29	— —
Input IP_3 ⁵	Two Tone Inputs up to +5 dBm	50 MHz 0.5 - 2.0 GHz	dBm dBm	— —	+35 +48	— —
Input IP_2 ⁵	Two Tone Inputs up to +5 dBm	50 MHz 0.5 - 2.0 GHz	dBm dBm	— —	+45 +79	— —
V_{CC} $-V_{EE}$	— —	— —	V V	4.5 -8.0	5.0 —	5.5 -5.0
I_{CC}	$V_{CC} = 4.5$ to 5.5V	—	mA	—	—	6.0
$-I_{EE}$	$-V_{EE} = -5.0$ to -8.0V	—	mA	—	—	1.0

- Above reference insertion loss.
- All specifications apply when operated with bias voltages of +5V for V_{CC} and -5.0 V to -8.0 V for V_{EE} and 50Ω impedance at all ports unless otherwise stated.
- This attenuator is guaranteed monotonic.
- For the attenuator to meet the guaranteed specifications, it is necessary to have a DC return on either RF1 or RF2. The DC return can be either a $10\text{K}\Omega$ resistor, or an RF choke.
- $V_{EE} = -5\text{V}$ for the typical numbers given.

Absolute Maximum Ratings^{6,7}

Parameter	Absolute Maximum
Max. Input Power 0.05 GHz 0.5 - 2.0 GHz	+27 dBm +34 dBm
V_{CC}	$-0.5\text{V} \leq V_{CC} \leq +7.0\text{V}$
V_{EE}	$-8.5\text{V} \leq V_{EE} \leq +0.5\text{V}$
$V_{CC} - V_{EE}$	$-0.5\text{V} \leq V_{CC} - V_{EE} \leq 14.5\text{V}$
V_{in}^8	$-0.5\text{V} \leq V_{in} \leq V_{CC} + 0.5\text{V}$
Operating Temperature	-40°C to $+125^\circ\text{C}$
Storage Temperature	-65°C to $+150^\circ\text{C}$

- Exceeding any one or combination of these limits may cause permanent damage to this device.
- M/A-COM does not recommend sustained operation near these survivability limits.
- Standard CMOS TTL interface, latch-up will occur if logic signal is applied prior to power supply.

Recommended PCB Configuration

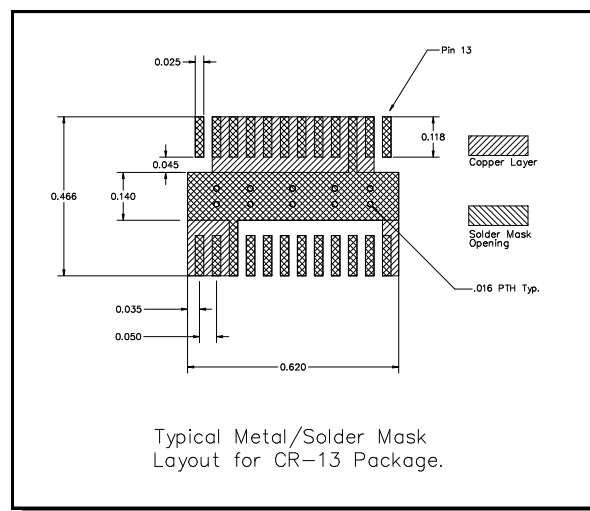

M/A-COM Technology Solutions Inc. (MACOM) and its affiliates reserve the right to make changes to the product(s) or information contained herein without notice. Visit www.macom.com for additional data sheets and product information.

Handling Procedures

Please observe the following precautions to avoid damage:

Static Sensitivity

Gallium Arsenide Integrated Circuits are sensitive to electrostatic discharge (ESD) and can be damaged by static electricity. Proper ESD control techniques should be used when handling these devices.

Typical Performance Curves

Insertion Loss vs. Frequency

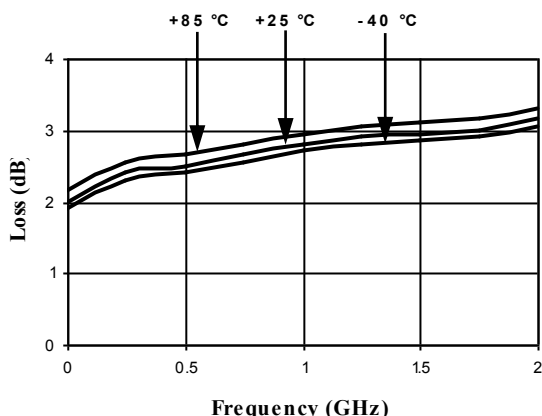

Attenuation Accuracy vs. Frequency

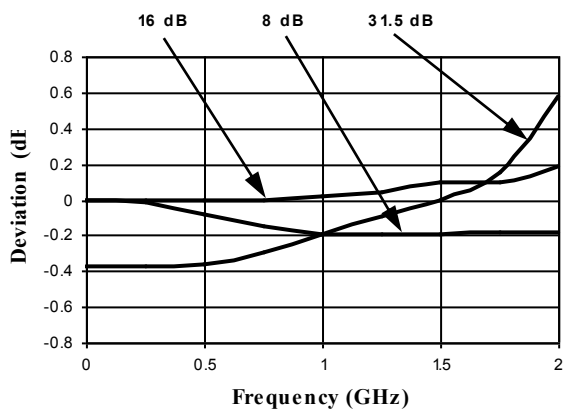

Truth Table (Digital Attenuator)

C16	C8	C4	C2	C1	C0.5	Attenuation
0	0	0	0	0	0	Loss, Reference
0	0	0	0	0	1	0.5 dB
0	0	0	0	1	0	1.0 dB
0	0	0	1	0	0	2.0 dB
0	0	1	0	0	0	4.0 dB
0	1	0	0	0	0	8.0 dB
1	0	0	0	0	0	16.0 dB
1	1	1	1	1	1	31.5 dB

0 = TTL Low; 1 = TTL High

Attenuation Accuracy vs. Frequency

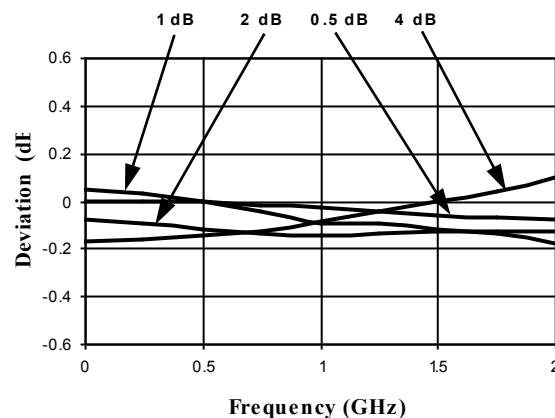

RF1 VSWR vs. Frequency

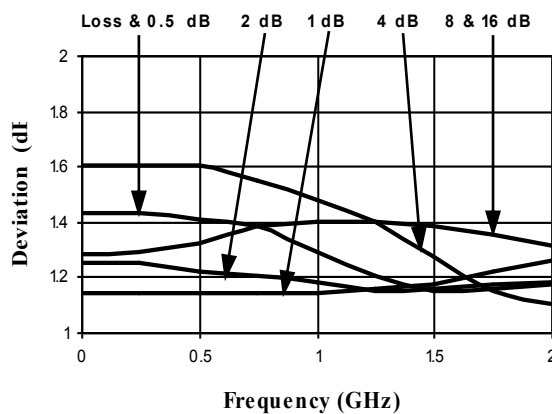

Typical Performance Curves

RF2 VSWR vs. Frequency

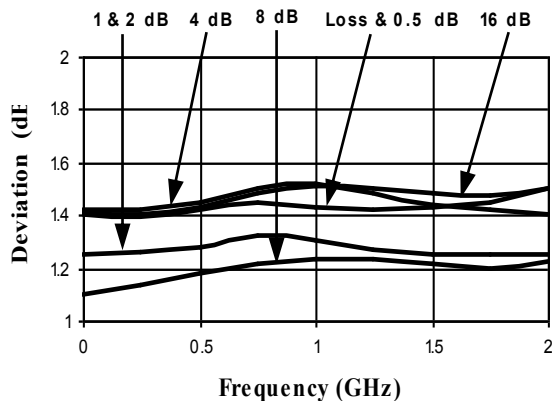

Lead-Free, CR-13 Ceramic Package[†]

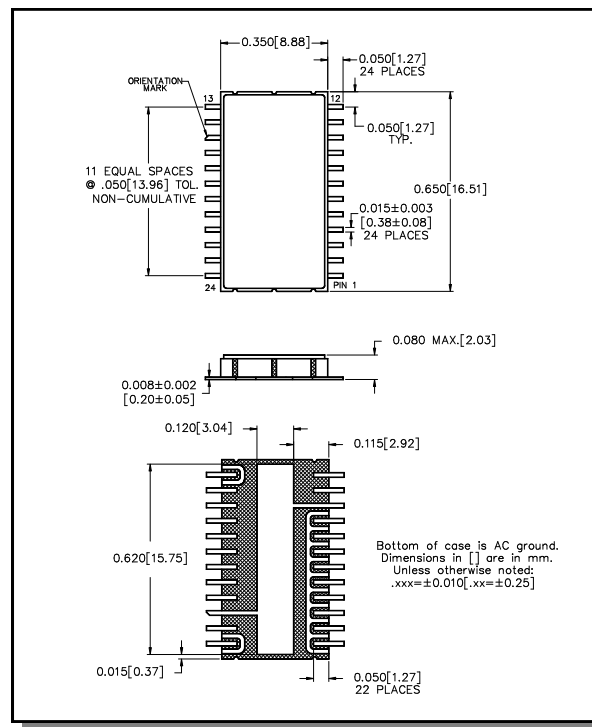

[†] Reference Application Note M538 for lead-free solder reflow recommendations.