

STK600-RC020T-44

Routing card for STK600

J3 and J4 mates with the socket card, while J1 and J2 goes down to the mother board. J1 is physical placed below J3, and J2 below J4.

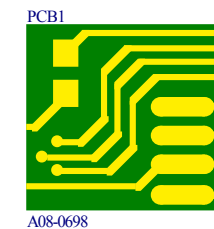
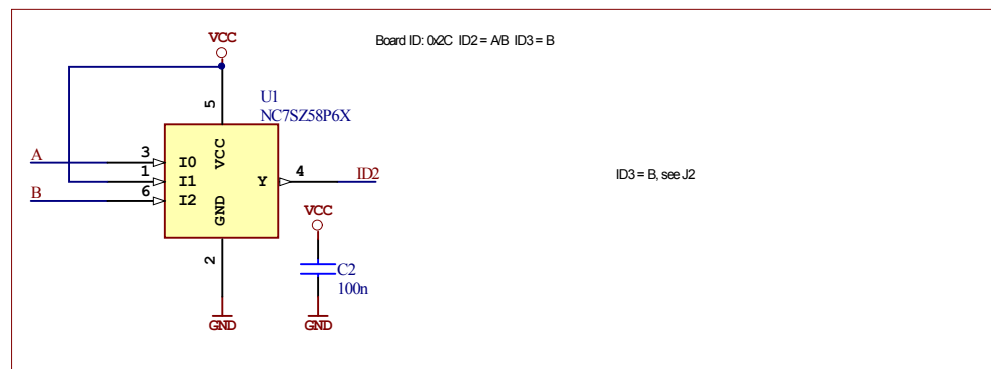
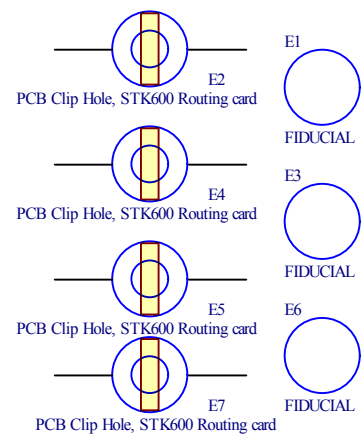
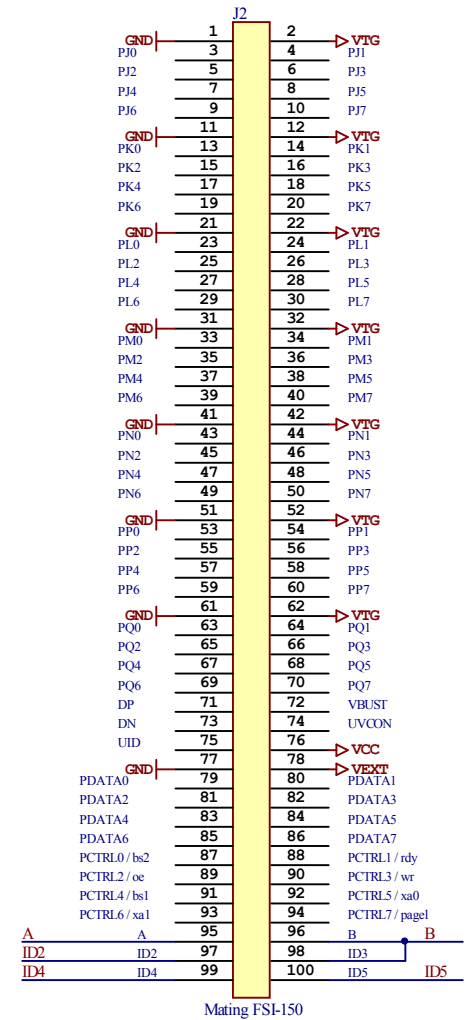
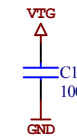
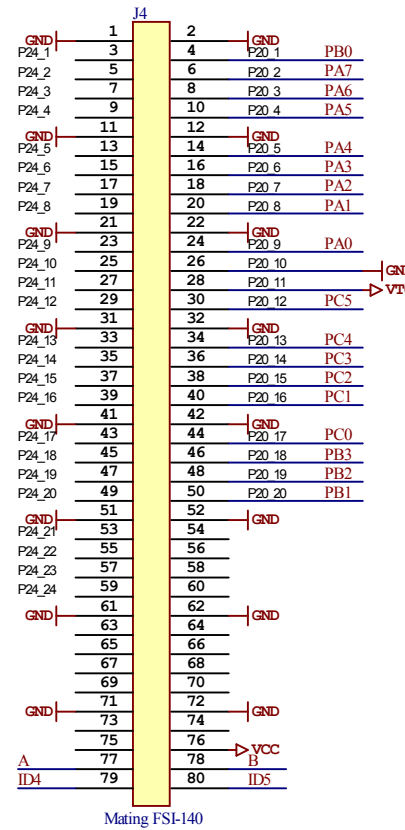
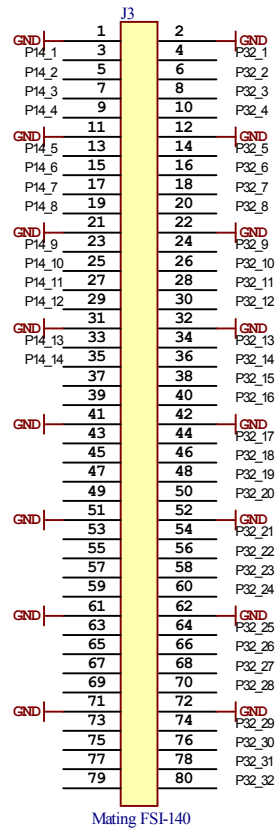
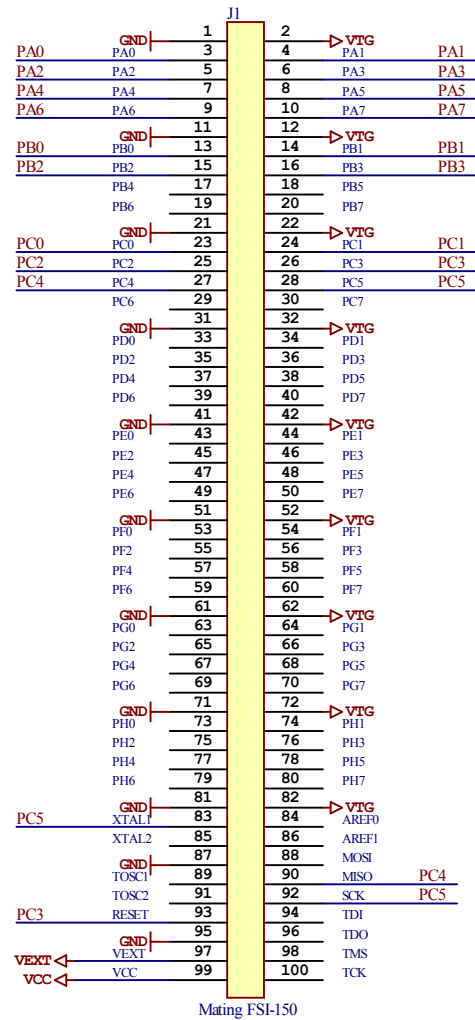

ATMEL Norway	*		
Vestre Rosten 79	*		
N-7075 TILLER	*		
NORWAY			
Date:	12.11.2009	12:50:02	PAGE: 1 of 1
Document number:	*		Revision: 1
TITLE: STK600-RC020T-44			
STK600-RC020T-44 . SchDoc			