

ATV02W5V0-HF Thru ATV02W191-HF

Working Peak Reverse Voltage:5.0-190 Volts

Peak Pulse Power:200 Watts

RoHS Device

Halogen Free

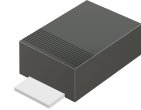

Features

- Glass passivated chip.
- Low leakage current.
- 200W peak pulse power capability with a 10/1000µs waveform, repetitive rate (duty cycle):0.01%.
- Uni and bidirectional unit.
- Excellent clamping capability.
- Very fast response time.
- Comply with AEC-Q101

Mechanical data

- Case: Molded plastic.
- Epoxy: UL 94V-0 rate flame retardant.
- Lead: Solderable per MIL-STD-750, method 2026.
- Polarity: Color band denotes cathode end except bipolar.
- Mounting position: Any.
- Weight: 0.016 grams(approx).

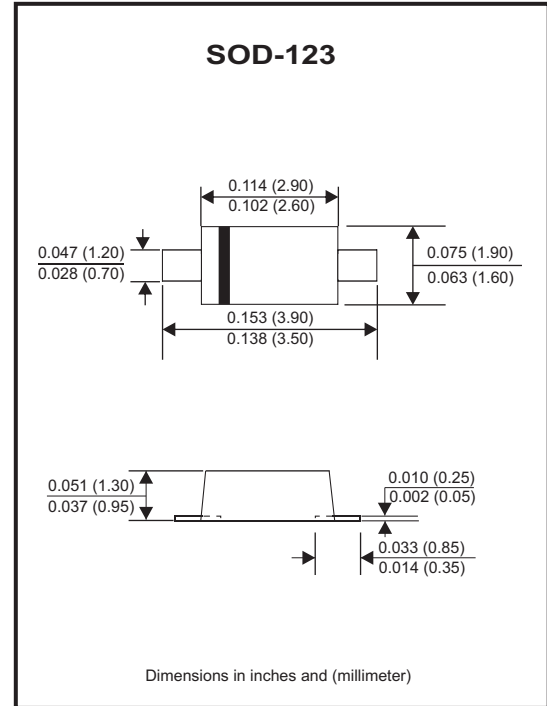

Circuit Diagram

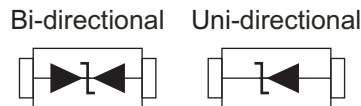

Maximum Rating and Electrical Characteristics

Ratings at 25°C ambient temperature unless otherwise specified.
 Single phase, half wave, 60Hz, resistive or inductive load.
 For capacitive load, derate current by 20%.

| Parameter | Symbol | Value | Unit | |
|--|----------------------------------|------------------|------|------|
| Peak power dissipation at 10/1000µs waveform (Note 1) | PPP | 200 | W | |
| Peak power dissipation at 8/20µs waveform (Note 1) | PPP | 1000 | W | |
| Peak pulse current with a 10/1000µs waveform (Note 1) | IPP | See next table | A | |
| Power dissipation on infinite heatsink at T _L = 75°C | PD | 0.4 | W | |
| Peak forward surge current, 8.3ms single half sine-wave unidirectional only (Note 2) | IFSM | 20 | A | |
| Max.instantaneous forward voltage at 25A for unidirectional only | V _F | 3.5 | V | |
| Typical thermal resistance (Note 3) | Junction to ambient | R _{θJA} | 200 | °C/W |
| | Junction to case | R _{θJC} | 100 | |
| Operating junction and storage temperature range | T _J ,T _{STG} | -55 to +150 | °C | |

Notes: 1. Non-repetitive current pulse, per Fig.3 and derated above T_A=25°C per Fig.1
 2. Measured on 8.3ms single half sine-wave or equivalent square wave, duty cycle=4 pulses per minute maximum.
 3. Thermal resistance from junction to ambient and from junction to case, mounted on 10x10mm copper pad areas.

Rating and Characteristic Curves (ATV02W5V0-HF Thru. ATV02W191-HF)

Fig. 1 - Pulse Derating Curve

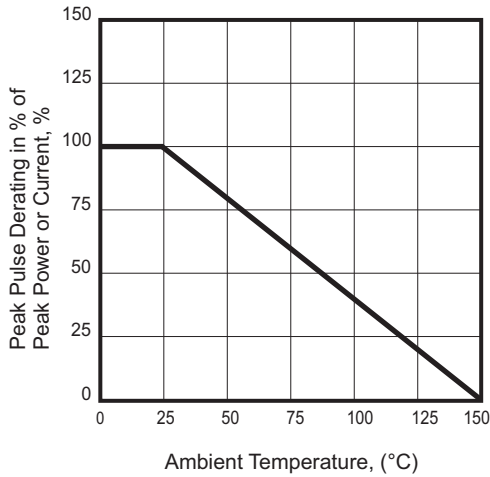

Fig.2 - Steady State Power Derating Curve

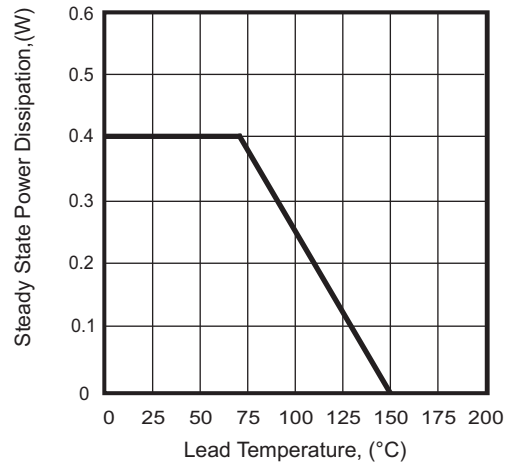

Fig. 3 - Pulse Waveform

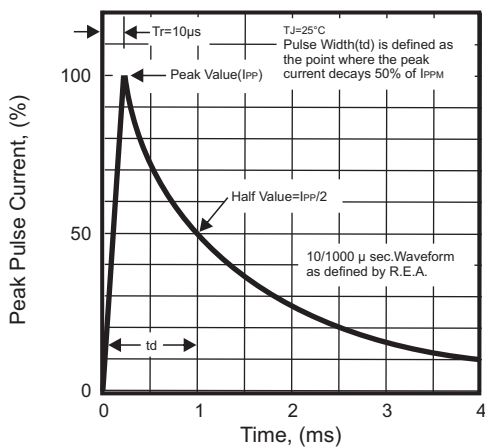

Fig. 4 - Peak Pulse Power Rating Curve

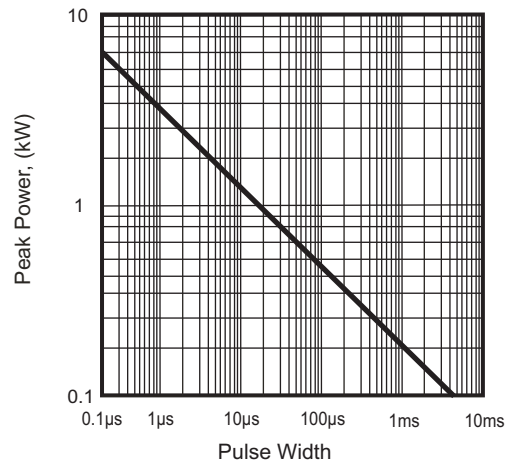

Fig. 5 - Maximum non-repetitive surge current

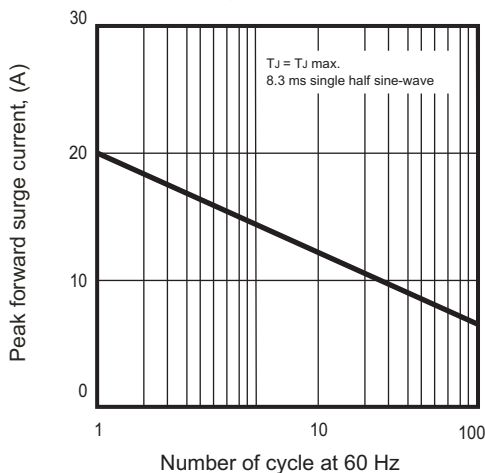
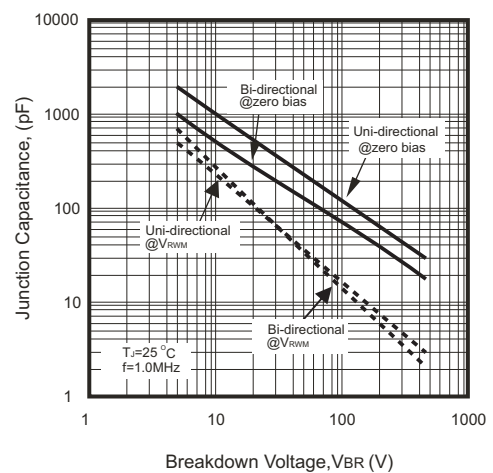

Fig.6 - Typical Junction Capacitance



SMD Transient Voltage Suppressor



Electrical Characteristics (ATV02W5V0-HF Thru. ATV02W191-HF)

| Part No | Absolute Maximum Rating (Ta=25°C) | | | | Vc (Max.) @ IPP | IPP @ 10/1000us | Ir @ VRWM | Marking Code | |
|-----------------|-----------------------------------|----------|----------|------|--------------------|--------------------|--------------|--------------|----|
| | VRWM | VBR Min. | VBR Max. | IT | | | | Uni | Bi |
| | (V) | (V) | (V) | (mA) | (V) | (A) | (uA) | | |
| ATV02W5V0(B)-HF | 5.0 | 6.40 | 7.00 | 10 | 9.20 | 21.74 | 400 | FE | KE |
| ATV02W6V0(B)-HF | 6.0 | 6.67 | 7.37 | 10 | 10.3 | 19.42 | 400 | FG | KG |
| ATV02W6V5(B)-HF | 6.5 | 7.22 | 7.98 | 10 | 11.2 | 17.86 | 250 | FK | KK |
| ATV02W7V0(B)-HF | 7.0 | 7.78 | 8.60 | 10 | 12.0 | 16.67 | 100 | FM | KM |
| ATV02W7V5(B)-HF | 7.5 | 8.33 | 9.21 | 1 | 12.9 | 15.50 | 50 | FP | KP |
| ATV02W8V0(B)-HF | 8.0 | 8.89 | 9.83 | 1 | 13.6 | 14.71 | 25 | FR | KR |
| ATV02W8V5(B)-HF | 8.5 | 9.44 | 10.40 | 1 | 14.4 | 13.89 | 10 | FT | KT |
| ATV02W9V0(B)-HF | 9.0 | 10.00 | 11.10 | 1 | 15.4 | 12.99 | 5 | FV | KV |
| ATV02W100(B)-HF | 10.0 | 11.10 | 12.30 | 1 | 17.0 | 11.76 | 2.5 | FX | KX |
| ATV02W110(B)-HF | 11.0 | 12.20 | 13.50 | 1 | 18.2 | 10.99 | 2.5 | FZ | KZ |
| ATV02W120(B)-HF | 12.0 | 13.30 | 14.70 | 1 | 19.9 | 10.05 | 2.5 | HE | LE |
| ATV02W130(B)-HF | 13.0 | 14.40 | 15.90 | 1 | 21.5 | 9.30 | 1 | HG | LG |
| ATV02W140(B)-HF | 14.0 | 15.60 | 17.20 | 1 | 23.2 | 8.62 | 1 | HK | LK |
| ATV02W150(B)-HF | 15.0 | 16.70 | 18.50 | 1 | 24.4 | 8.20 | 1 | HM | LM |
| ATV02W160(B)-HF | 16.0 | 17.80 | 19.70 | 1 | 26.0 | 7.69 | 1 | HP | LP |
| ATV02W170(B)-HF | 17.0 | 18.90 | 20.90 | 1 | 27.6 | 7.25 | 1 | HR | LR |
| ATV02W180(B)-HF | 18.0 | 20.00 | 22.10 | 1 | 29.2 | 6.85 | 1 | HT | LT |
| ATV02W190(B)-HF | 19.0 | 21.10 | 23.30 | 1 | 30.6 | 6.54 | 1 | HB | LB |
| ATV02W200(B)-HF | 20.0 | 22.20 | 24.50 | 1 | 32.4 | 6.17 | 1 | HV | LV |
| ATV02W220(B)-HF | 22.0 | 24.4 | 26.90 | 1 | 35.5 | 5.63 | 1 | HX | LX |
| ATV02W240(B)-HF | 24.0 | 26.70 | 29.50 | 1 | 38.9 | 5.14 | 1 | HZ | LZ |
| ATV02W260(B)-HF | 26.0 | 28.90 | 31.90 | 1 | 42.1 | 4.75 | 1 | JE | ME |
| ATV02W280(B)-HF | 28.0 | 31.10 | 34.40 | 1 | 45.4 | 4.41 | 1 | JG | MG |
| ATV02W300(B)-HF | 30.0 | 33.30 | 36.80 | 1 | 48.4 | 4.13 | 1 | JK | MK |
| ATV02W330(B)-HF | 33.0 | 36.70 | 40.60 | 1 | 53.3 | 3.75 | 1 | JM | MM |
| ATV02W360(B)-HF | 36.0 | 40.00 | 44.20 | 1 | 58.1 | 3.44 | 1 | JP | MP |
| ATV02W400(B)-HF | 40.0 | 44.40 | 49.10 | 1 | 64.5 | 3.10 | 1 | JR | MR |
| ATV02W430(B)-HF | 43.0 | 47.80 | 52.80 | 1 | 69.4 | 2.88 | 1 | JT | MT |
| ATV02W450(B)-HF | 45.0 | 50.00 | 55.30 | 1 | 72.7 | 2.75 | 1 | JV | MV |
| ATV02W480(B)-HF | 48.0 | 53.30 | 58.90 | 1 | 77.4 | 2.58 | 1 | JX | MX |
| ATV02W510(B)-HF | 51.0 | 56.70 | 62.70 | 1 | 82.4 | 2.43 | 1 | JZ | MZ |
| ATV02W540(B)-HF | 54.0 | 60.00 | 66.30 | 1 | 87.1 | 2.30 | 1 | XE | NE |
| ATV02W580(B)-HF | 58.0 | 64.40 | 71.20 | 1 | 93.6 | 2.14 | 1 | XG | NG |
| ATV02W600(B)-HF | 60.0 | 66.70 | 73.70 | 1 | 96.8 | 2.07 | 1 | XK | NK |
| ATV02W640(B)-HF | 64.0 | 71.10 | 78.60 | 1 | 103.0 | 1.94 | 1 | XM | NM |
| ATV02W700(B)-HF | 70.0 | 77.80 | 86.00 | 1 | 113.0 | 1.77 | 1 | XP | NP |
| ATV02W750(B)-HF | 75.0 | 83.30 | 92.10 | 1 | 121.0 | 1.65 | 1 | XR | NR |
| ATV02W780(B)-HF | 78.0 | 86.70 | 95.80 | 1 | 126.0 | 1.59 | 1 | XT | NT |
| ATV02W800(B)-HF | 80.0 | 88.80 | 97.60 | 1 | 129.0 | 1.55 | 1 | XB | NB |
| ATV02W850(B)-HF | 85.0 | 94.40 | 104.00 | 1 | 137.0 | 1.46 | 1 | XV | NV |
| ATV02W900(B)-HF | 90.0 | 100.00 | 111.00 | 1 | 146.0 | 1.37 | 1 | XX | NX |
| ATV02W101(B)-HF | 100.0 | 111.00 | 123.00 | 1 | 162.0 | 1.23 | 1 | XZ | NZ |
| ATV02W111(B)-HF | 110.0 | 122.00 | 135.00 | 1 | 177.0 | 1.13 | 1 | TE | PE |
| ATV02W121(B)-HF | 120.0 | 133.00 | 147.00 | 1 | 193.0 | 1.04 | 1 | TG | PG |
| ATV02W131(B)-HF | 130.0 | 144.00 | 159.00 | 1 | 209.0 | 0.96 | 1 | TK | PK |
| ATV02W141(B)-HF | 140.0 | 155.00 | 171.00 | 1 | 224.0 | 0.89 | 1 | TB | PB |
| ATV02W151(B)-HF | 150.0 | 167.00 | 185.00 | 1 | 243.0 | 0.82 | 1 | TM | PM |
| ATV02W161(B)-HF | 160.0 | 178.00 | 197.00 | 1 | 259.0 | 0.77 | 1 | TP | PP |
| ATV02W171(B)-HF | 170.0 | 189.00 | 209.00 | 1 | 275.0 | 0.73 | 1 | TR | PR |
| ATV02W181(B)-HF | 180.0 | 200.00 | 220.00 | 1 | 292.0 | 0.68 | 1 | TT | PT |
| ATV02W191(B)-HF | 190.0 | 211.00 | 232.00 | 1 | 308.0 | 0.65 | 1 | TV | PV |

Notes:

1. Suffix B after part number to specify bi-directional devices.
2. For Bi-Directional devices having Vr of 10 volts and under, the Ir limit is double.

Company reserves the right to improve product design , functions and reliability without notice.

REV: C

Reel Taping Specification

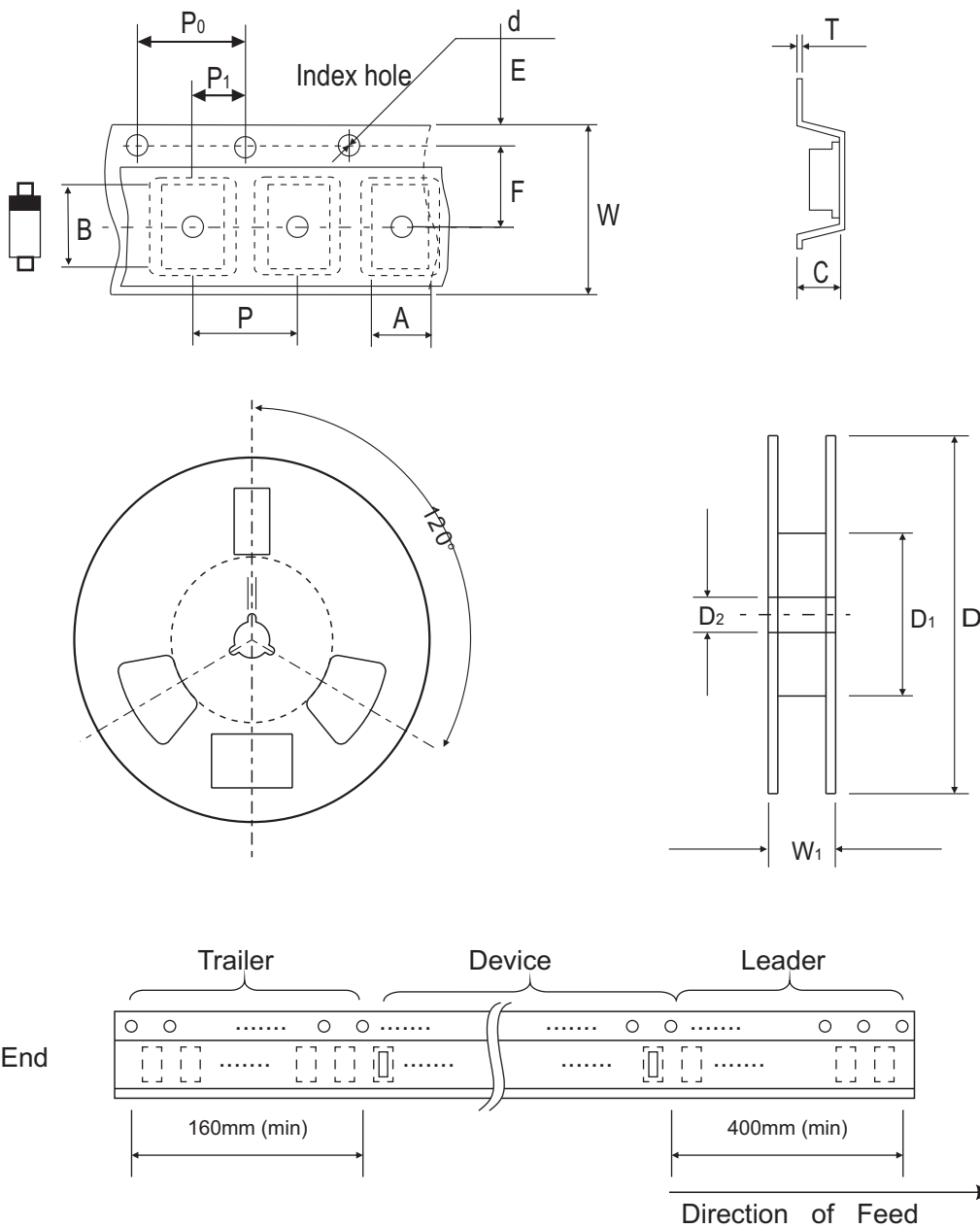

| SOD-123 | SYMBOL | A | B | C | d | D | D1 | D2 |
|---------|--------|---------------|---------------|---------------|---------------|---------------|------------|---------------|
| | (mm) | 1.85 ± 0.10 | 3.94 ± 0.10 | 1.57 ± 0.10 | 1.55 ± 0.05 | 178.00 ± 1.00 | 50.00 Min. | 13.00 ± 0.20 |
| | (inch) | 0.073 ± 0.004 | 0.155 ± 0.004 | 0.062 ± 0.004 | 0.061 ± 0.002 | 7.008 ± 0.039 | 1.969 Min. | 0.512 ± 0.008 |

| SOD-123 | SYMBOL | E | F | P | P0 | P1 | W | W1 |
|---------|--------|---------------|---------------|---------------|---------------|---------------|---------------|------------|
| | (mm) | 1.75 ± 0.10 | 3.50 ± 0.05 | 4.00 ± 0.10 | 4.00 ± 0.10 | 2.00 ± 0.05 | 8.00 ± 0.10 | 11.40 Max. |
| | (inch) | 0.069 ± 0.004 | 0.138 ± 0.002 | 0.157 ± 0.004 | 0.157 ± 0.004 | 0.079 ± 0.002 | 0.315 ± 0.004 | 0.449 Max. |