

# Anybus<sup>®</sup> Wireless Bolt LTE<sup>™</sup>

## USER MANUAL

SCM-1202-164 1.1 en-US ENGLISH



---

# Important User Information

## Disclaimer

The information in this document is for informational purposes only. Please inform HMS Networks of any inaccuracies or omissions found in this document. HMS Networks disclaims any responsibility or liability for any errors that may appear in this document.

HMS Networks reserves the right to modify its products in line with its policy of continuous product development. The information in this document shall therefore not be construed as a commitment on the part of HMS Networks and is subject to change without notice. HMS Networks makes no commitment to update or keep current the information in this document.

The data, examples and illustrations found in this document are included for illustrative purposes and are only intended to help improve understanding of the functionality and handling of the product. In view of the wide range of possible applications of the product, and because of the many variables and requirements associated with any particular implementation, HMS Networks cannot assume responsibility or liability for actual use based on the data, examples or illustrations included in this document nor for any damages incurred during installation of the product. Those responsible for the use of the product must acquire sufficient knowledge in order to ensure that the product is used correctly in their specific application and that the application meets all performance and safety requirements including any applicable laws, regulations, codes and standards. Further, HMS Networks will under no circumstances assume liability or responsibility for any problems that may arise as a result from the use of undocumented features or functional side effects found outside the documented scope of the product. The effects caused by any direct or indirect use of such aspects of the product are undefined and may include e.g. compatibility issues and stability issues.

---

# Table of Contents

Page

<b>1</b>	<b>Preface .....</b>	<b>3</b>
1.1	About This Document .....	3
1.2	Document Conventions .....	4
1.3	Trademarks.....	4
<b>2</b>	<b>Safety .....</b>	<b>5</b>
2.1	General Safety Instructions .....	5
2.2	Intended Use.....	5
<b>3</b>	<b>Preparation.....</b>	<b>6</b>
3.1	Support and Downloads .....	6
3.2	Network Environment.....	6
3.3	SIM Card .....	6
3.4	Network Operator Certified Firmware .....	6
3.5	Placement .....	7
3.6	Firewall and Routing.....	7
<b>4</b>	<b>Installation.....</b>	<b>8</b>
4.1	Installing SIM Card .....	8
4.2	Mechanical Installation .....	9
4.3	Connecting to Power Over Ethernet (PoE) .....	10
4.4	Connecting to Power and Ethernet.....	11
<b>5</b>	<b>Configuration.....</b>	<b>14</b>
5.1	Connecting to PC and Power .....	14
5.2	PC IP Address Setting .....	15
5.3	Accessing Wireless Bolt LTE Web Interface .....	16
5.4	Web Interface Overview.....	17
5.5	Save and Reboot.....	18
5.6	Factory Default Settings .....	18
5.7	Ethernet Settings .....	19
5.8	Cellular Settings.....	21
5.9	NAT/Port Forward Settings .....	25
5.10	Positioning Settings .....	26
5.11	Setting Up with REST Commands .....	27
<b>6</b>	<b>Configuration Examples .....</b>	<b>28</b>
6.1	Setting Up Wireless Bolt LTE as an Internet Router.....	28
6.2	Setting Up Wireless Bolt LTE with ULPM REST Command .....	31

---

<b>7</b>	<b>Verify Operation.....</b>	<b>32</b>
7.1	System Settings and Network Connection.....	32
7.2	Ethernet LED Status Indication .....	33
<b>8</b>	<b>Maintenance.....</b>	<b>34</b>
8.1	Firmware Update .....	34
8.2	Set Administrator Password .....	36
8.3	Settings Backup .....	36
8.4	Reboot System .....	38
<b>9</b>	<b>Troubleshooting .....</b>	<b>39</b>
9.1	Logs.....	39
9.2	Diagnostics .....	40
9.3	Reset and Recovery .....	43
<b>10</b>	<b>Technical Data .....</b>	<b>45</b>
10.1	Technical Specifications.....	45

# 1 Preface

## 1.1 About This Document

This manual describes how to install and configure Anybus Wireless Bolt LTE.

For additional documentation and software downloads, FAQs, troubleshooting guides and technical support, please visit [www.anybus.com/support](http://www.anybus.com/support).

## 1.2 Document Conventions

Numbered lists indicate tasks that should be carried out in sequence:

1. First do this
2. Then do this

Bulleted lists are used for:

- Tasks that can be carried out in any order
- Itemized information
- ▶ An action
  - and a result

**User interaction elements** (buttons etc.) are indicated with bold text.

```
Program code and script examples
```

Cross-reference within this document: [Document Conventions, p. 4](#)

External link (URL): [www.hms-networks.com](http://www.hms-networks.com)



### **WARNING**

Instruction that must be followed to avoid a risk of death or serious injury.



### **Caution**

Instruction that must be followed to avoid a risk of personal injury.



Instruction that must be followed to avoid a risk of reduced functionality and/or damage to the equipment, or to avoid a network security risk.



*Additional information which may facilitate installation and/or operation.*

## 1.3 Trademarks

Anybus® is a registered trademark and Wireless Bolt LTE™ is a trademark of HMS Networks AB. All other trademarks mentioned in this document are the property of their respective holders.

## 2 Safety

### 2.1 General Safety Instructions

**Caution**

This equipment emits RF energy in the ISM (Industrial, Scientific, Medical) band. Make sure that all medical devices used in proximity to this equipment meet appropriate susceptibility specifications for this type of RF energy.

**Caution**

Minimum temperature rating of the cable to be connected to the field wiring terminals, 90 °C.

**Caution**

Use copper wire only for field wiring terminals.



This equipment is recommended for use in both industrial and domestic environments. For industrial environments it is mandatory to use the functional earth connection to comply with immunity requirements. For domestic environments the functional earth must be used if a shielded Ethernet cable is used, in order to meet emission requirements.



This equipment contains parts that can be damaged by electrostatic discharge (ESD). Use ESD prevention measures to avoid damage.

### 2.2 Intended Use

The intended use of this equipment is as a communication interface and router. The equipment receives and transmits data over Ethernet and Cellular standard networks.

## 3 Preparation

### 3.1 Support and Downloads

For additional documentation and software downloads, FAQs, troubleshooting guides and technical support, please visit [www.anybus.com/support](http://www.anybus.com/support).



*Have the product article number available, to search for the specific product page.*

*You find the product article number on the Wireless Bolt LTE product housing.*

---

### 3.2 Network Environment

Ensure that you have all the necessary information about the capabilities and restrictions of your local network environment before installation.

### 3.3 SIM Card

#### Prepaid Data Plan

If a prepaid data plan is used, ensure that:

- the data amount is sufficient
- that any SMS notifications are sent to a monitored number

### 3.4 Network Operator Certified Firmware

You may need to install a firmware certified for the operator you are going to use, it is not possible to connect the Wireless Bolt LTE to the operator network otherwise.

Before you start to configure the Wireless Bolt LTE settings:

- Ensure that the current firmware installed on the Wireless Bolt LTE is valid for the network operator you are going to use.
- You find the firmware version number in the Wireless Bolt LTE built-in web interface Overview page. Refer to [Web Interface Overview, p. 17](#).
- If you need to install a firmware version certified for your network operator:  
Download the firmware update file, specific for your network operator, from [www.anybus.com/support](http://www.anybus.com/support).
- For information on how to update the firmware, refer to [Firmware Update, p. 34](#).



### 3.5 Placement

For optimal reception, cellular devices should not be confined in buildings made of concrete or metal, without windows.

To avoid interference, a minimum distance of 50 cm between cellular devices should be observed.

At least 20 cm separation distance between the device and the user's body must be maintained at all times.

### 3.6 Firewall and Routing

There are routing options set for the system.

By default, the firewall allow routing of:

- Outgoing traffic for TCP, UDP and ICMP (for ipv4 only).
- Ingoing traffic for already established connections only.

For other possible configurations, refer to [NAT/Port Forward Settings, p. 25](#).

## 4 Installation

### 4.1 Installing SIM Card



*Supported SIM card types are Nano SIM for IoT and M2M, for data communication, as well as standard mobile phone Nano SIM.*

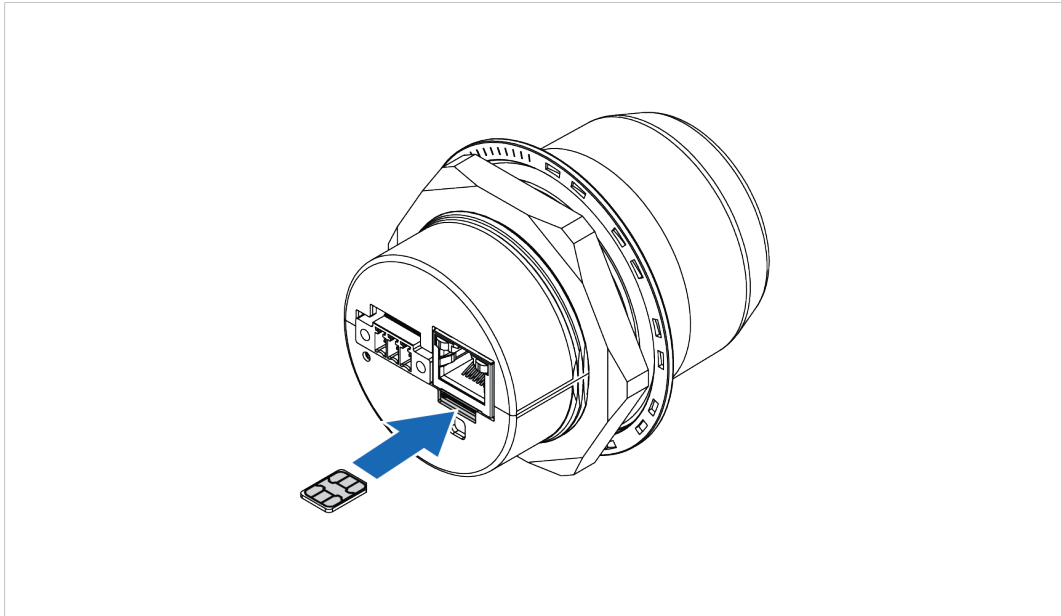

**Fig. 1**

To connect Wireless Bolt LTE to a cellular data network, install a cellular SIM card:

1. Insert a *SIM card* into the Wireless Bolt LTE *SIM card holder*.



*Ensure that the SIM card contact surface is facing towards the Ethernet port.*

## 4.2 Mechanical Installation

### Placement

- The device is intended to be mounted on top of a machine or cabinet through an M50 (50.5 mm) hole using the included sealing ring and nut.
- The top mounting surface, in contact with the sealing, must be flat with a finish equivalent to Ra 3.2 or finer and cleaned and free from oils and greases.
- For optimal reception, cellular devices require a zone around them clear of objects that could obstruct or reflect the signal. To avoid interference, a minimum distance of 50 cm between Wireless Bolt LTE and other cellular devices should be observed.



Make sure that the sealing ring is correctly placed in the circular groove in the top part of the housing before tightening the nut.



Always hold the BOTTOM part of the unit when untightening the nut, not the top part (the cap).

**Tightening torque: 5 Nm  $\pm$ 10 %**

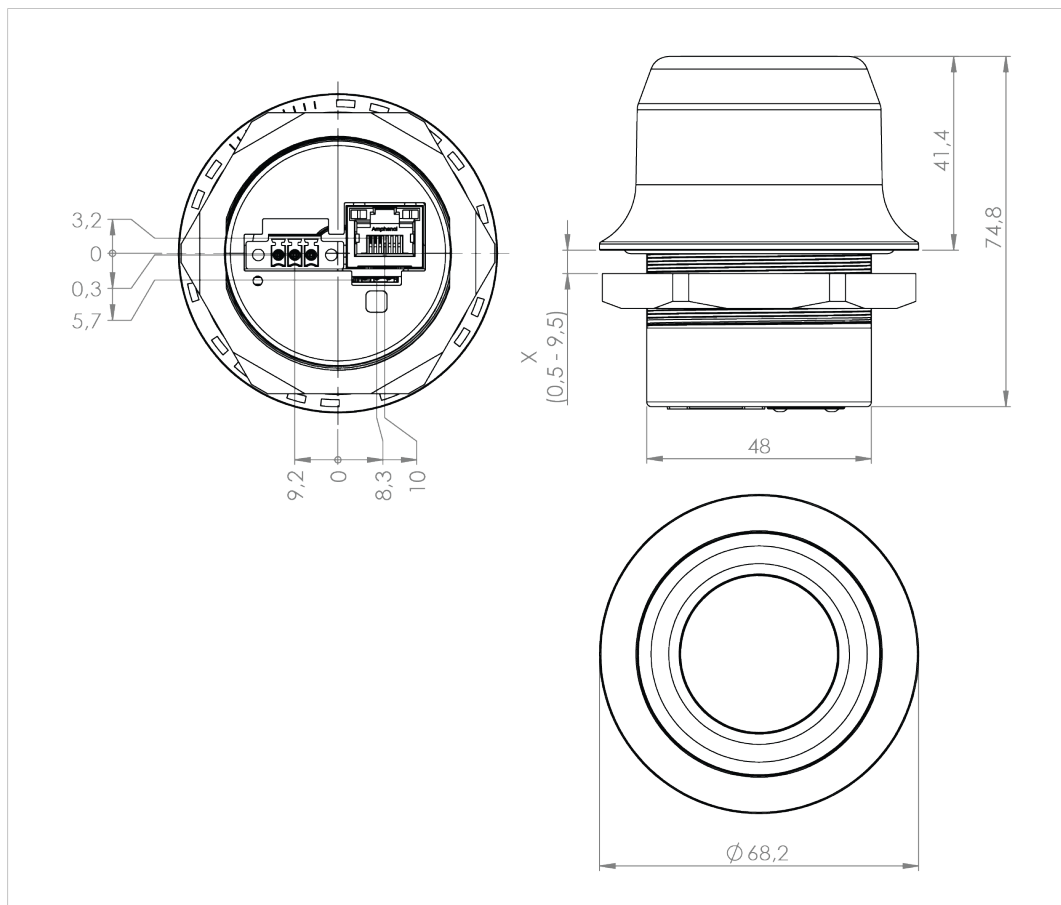

**Fig. 2** Installation drawing

All measurements are in mm.

### 4.3 Connecting to Power Over Ethernet (PoE)

#### Before You Begin

**!** Connecting the Wireless Bolt LTE to PoE and DC power simultaneously may result in a current loop that could damage both the power sources and the Wireless Bolt LTE. Ensure to use only one of the power connections at a time.

**i** Shielded or unshielded Ethernet cables may be used.

**i** Wireless Bolt LTE is designed to comply with PoE, IEEE 802.3at Type 1 (Class 0, 37-57 VDC, max 12.95 W).

#### Procedure

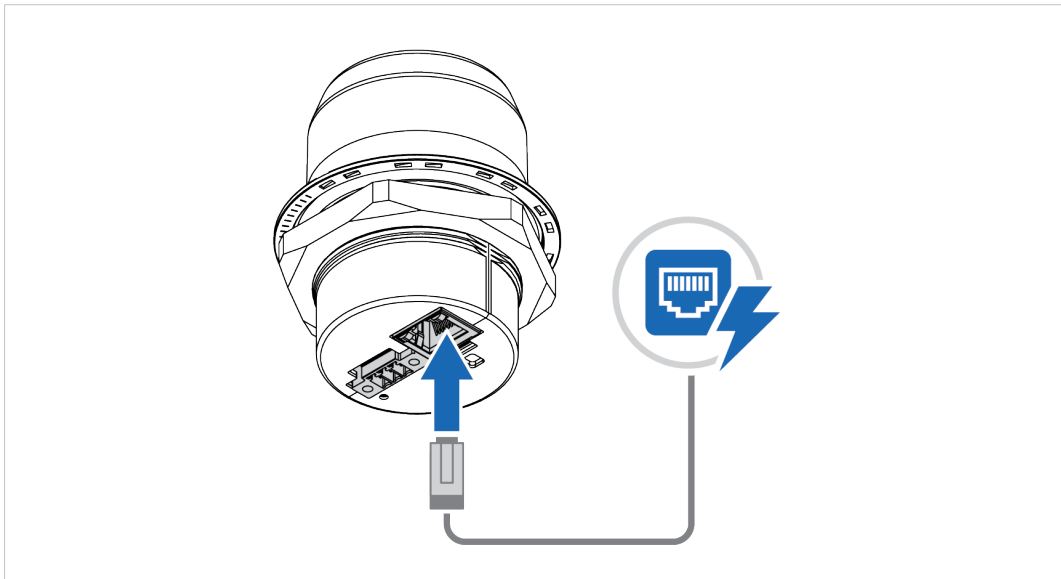
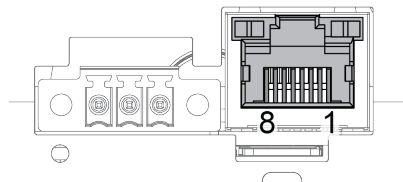

Fig. 3

1. Connect the Wireless Bolt LTE Ethernet port to Ethernet/PoE.

#### Ethernet Connector, RJ45 PoE



Pin	Data	PoE	
1	TD+	A+	Positive power from alt. A PSE
2	TD-		
3	RD+	A-	Negative power from alt. A PSE (with pin 6)
4		B+	Positive power from alt. B PSE
5			
6	RD-	A-	Negative power from alt. A PSE (with pin 3)
7		B-	Negative power from alt. B PSE
8			
Housing	Shield	Functional Earth (FE), via 1 nF capacitor and 1 MΩ bleeder resistor	

## 4.4 Connecting to Power and Ethernet

### Before You Begin



Connecting power with reverse polarity or using the wrong type of power supply may damage the equipment. Make sure that the power supply is connected correctly and of the recommended type.



Connecting the Wireless Bolt LTE to PoE and DC power simultaneously may result in a current loop that could damage both the power sources and the Wireless Bolt LTE. Ensure to use only one of the power connections at a time.



When Wireless Bolt LTE is powered via the power connector, Functional Earth (FE) must be connected.



When Wireless Bolt LTE is installed in an environment with a high level of electrical noise, use a power/Functional Earth (FE) cable with a maximum length of 3 meters.

See also [Technical Data, p. 45](#) regarding power supply requirements.

### Functional earth wire screw placement

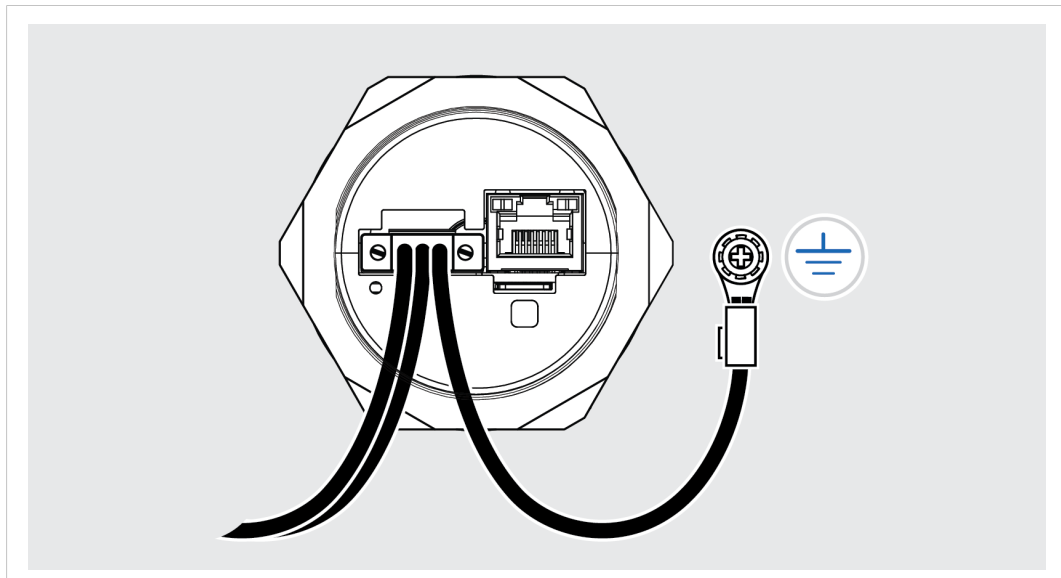
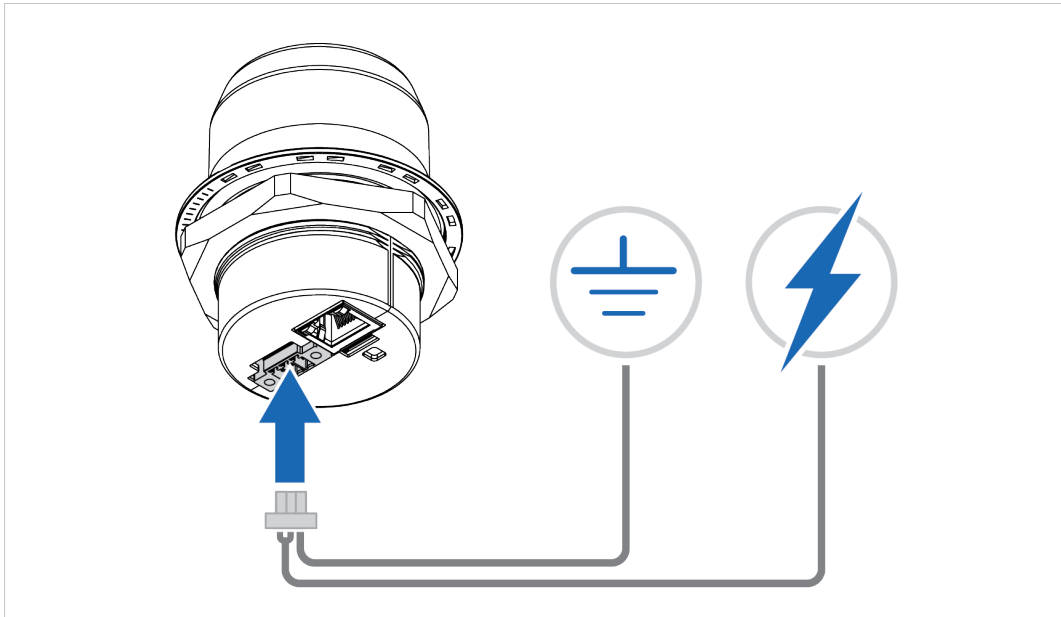

Fig. 4

When Wireless Bolt LTE is mounted on a sheet metal plate, connect Functional Earth (FE) to the plate near Wireless Bolt LTE.

**Procedure**

**Connecting to power**



**Fig. 5**

1. Connect Wireless Bolt LTE *Power connector* to a power supply.
2. Connect Wireless Bolt LTE *Power connector* to Functional Earth (FE).

**Power connector, 3-pin terminal block**

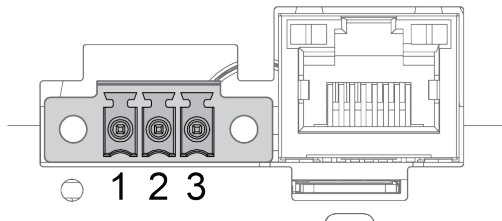

Pin	Function	
1	+	11–33 VDC
2	-	
3	Functional Earth (FE)	

**Connecting to Ethernet**

3. Connect the Wireless Bolt LTE to Ethernet.

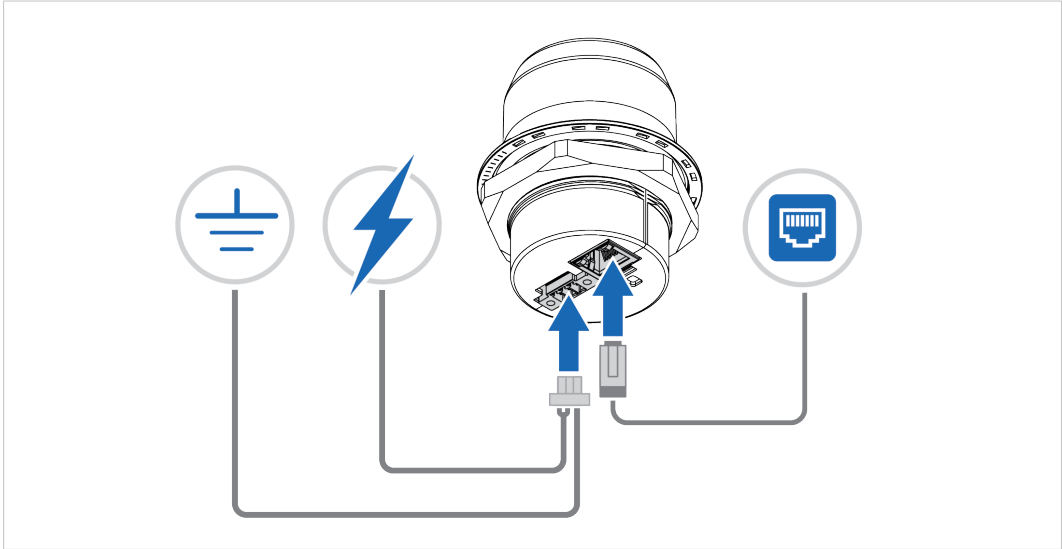

Fig. 6

## 5 Configuration

### 5.1 Connecting to PC and Power

When configuring Wireless Bolt LTE it must be connected to a PC.

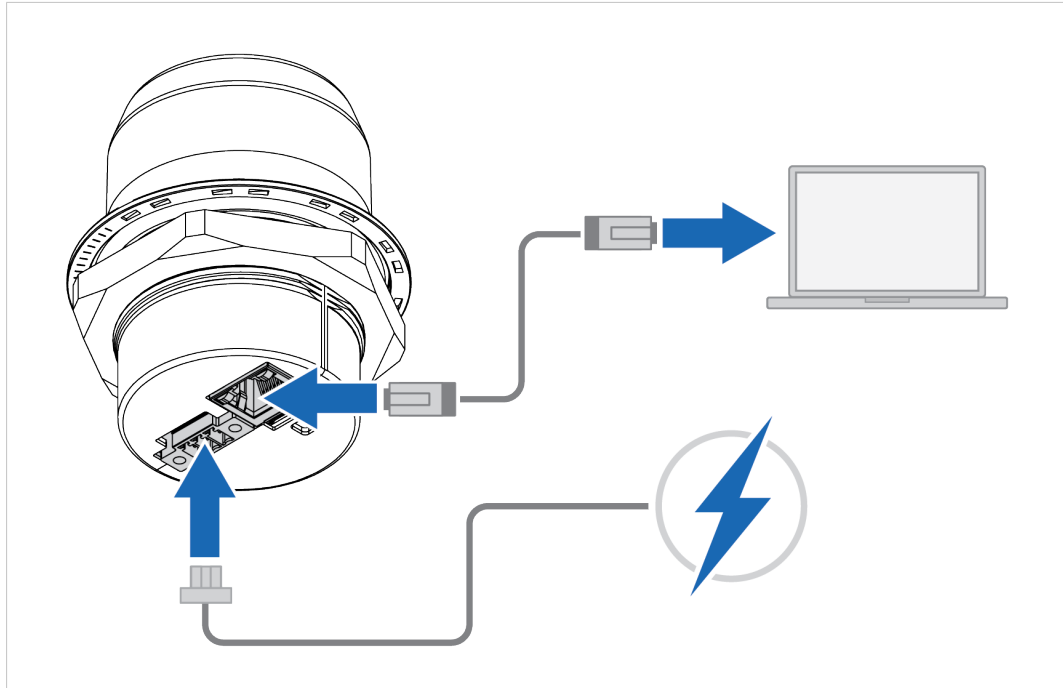

Fig. 7

1. Connect the *Wireless Bolt LTE Ethernet port* to your PC.
2. Connect the *Wireless Bolt LTE Power connector* to a power supply.



## 5.2 PC IP Address Setting



By default, the Wireless Bolt LTE internal DHCP server is enabled.  
To avoid interference, keep only one DHCP server enabled on the network.



Wireless Bolt LTE default IP address is **192.168.0.98**.

### Set a Static IP Address on Your PC

On the PC accessing the Wireless Bolt LTE built-in web interface:

1. Set a static IP address within the same IP address range as the Wireless Bolt LTE IP address.

### Result

→ Now you can enter the Wireless Bolt LTE IP address in your web browser and search to access the built-in web interface login page.

Refer to [Accessing Wireless Bolt LTE Web Interface, p. 16](#)

## 5.3 Accessing Wireless Bolt LTE Web Interface

The Wireless Bolt LTE built-in web interface can be accessed from standard web browsers.



Before installing the Wireless Bolt LTE on a network, change the Wireless Bolt LTE default password.



The Wireless Bolt LTE comes with a default username and password.

The default username is **admin**. Written in lowercase letters.

You find the default password on the Wireless Bolt LTE product housing.



Wireless Bolt LTE default IP address is **192.168.0.98**.

Login to the Wireless Bolt LTE built-in web interface:

1. Open a web browser.
2. Click to select the **Address bar** and enter *http://* and the *Wireless Bolt LTE IP address*.

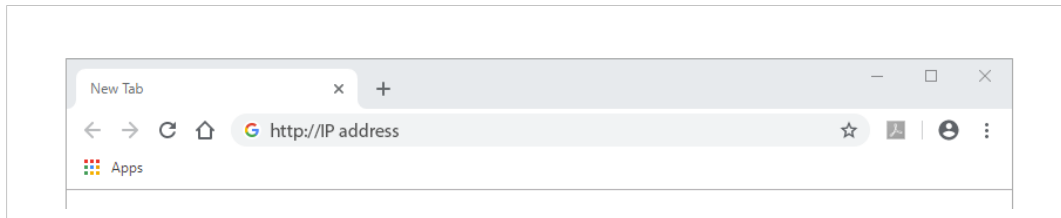

Fig. 8

3. Press **Enter**.  
→ The built-in web interface login screen appears.
4. Enter *Username* and *Password* and click **Sign in**.

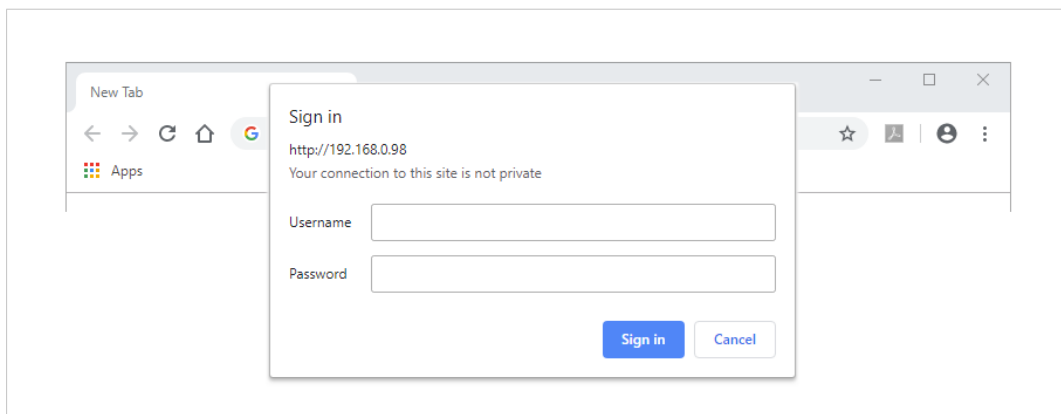

Fig. 9

## 5.4 Web Interface Overview

The Wireless Bolt LTE built-in web interface is used to configure the Wireless Bolt LTE system settings as well as for diagnostics and maintenance.

The *System Overview* page shows the current settings and network connection status.

The screenshot displays the Anybus Wireless Bolt LTE web interface. At the top, the Anybus logo and 'Wireless Bolt LTE™' are visible. The left sidebar menu (B) lists various settings categories: System Overview, Ethernet Settings, Cellular Settings, NAT/Port Forward Settings, Positioning Settings, Firmware Update, Logs, System, and Diagnostics. Below the menu are two buttons: 'Save and Reboot' (C) and 'Cancel All Changes'. The main content area (A) shows the following information:

- Ethernet**: Internal DHCP Server is **Enabled**.
- DHCP Table**: A table with columns for IP Address and MAC Address. The IP Address is 192.168.0.178 and the MAC Address is 00:0a:75:18:aa:48.
- Cellular**: Data Connection is **Yes**, Signal Strength is **Strong signal (4)**, Operator is **nor.net**, SIM Card is **SIM card inserted and unlocked**, Status is **Registered to a roaming network**, Network Type is **LTE network**, and APN is **data.rewicom.net**.
- System**: Firmware is **0.0.0-latest-dev**, Time (UTC) is **2021-01-08 13:13:59**, and Uptime is **2 hours 35 minutes 8 seconds**.

**Fig. 10** Wireless Bolt LTE built-in web interface, example

- A. **System Overview**  
Shows the current settings and network connection status
- B. **Left sidebar menu**
  - System Overview
  - Ethernet Settings
  - Cellular Settings
  - NAT/Port Forward Settings
  - Positioning Settings
  - Firmware Update
  - Logs
  - System
  - Diagnostics
- C. **Save and Reboot** button and **Cancel All Changes** button

## 5.5 Save and Reboot

### Cancel Changes

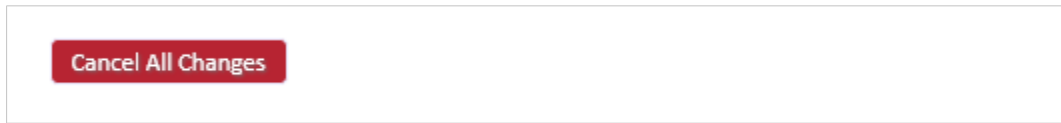

Fig. 11

If you need to cancel the changes you have made to the settings:

1. In the left sidebar menu, click **Cancel All Changes**.

To restore settings, refer to [Restore Settings, p. 37](#).

### Apply Changes



Fig. 12

To apply changes:

1. In the left sidebar menu, click **Save and Reboot**.
  - Wireless Bolt LTE restarts for the changes to take effect.

## 5.6 Factory Default Settings

Wireless Bolt LTE comes with the following factory default settings.

Wireless Bolt LTE default settings	
IP Assignment	Static
IP Address	192.168.0.98
Subnet Mask	255.255.255.0
Default Gateway	192.168.0.98
Internal DHCP Server	Enabled
Network Type	Modem Preset List Connects automatically to an available network according to priority order LTE, UMTS and GSM mobile network.
Incoming Traffic	NAT/Port Forward incoming traffic is Disabled.

You can restore factory default settings by making a *Factory Reset*. Refer to [Factory Reset, p. 43](#)

## 5.7 Ethernet Settings

On the **Ethernet Settings** page:

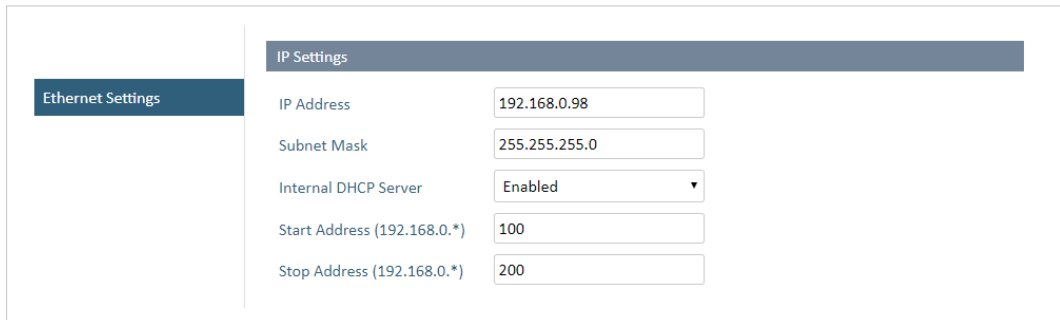

The screenshot shows the 'Ethernet Settings' page with a sidebar on the left containing a link to 'Ethernet Settings'. The main content area is titled 'IP Settings' and contains the following fields:

IP Address	<input type="text" value="192.168.0.98"/>
Subnet Mask	<input type="text" value="255.255.255.0"/>
Internal DHCP Server	<input type="button" value="Enabled"/>
Start Address (192.168.0.*)	<input type="text" value="100"/>
Stop Address (192.168.0.*)	<input type="text" value="200"/>

Fig. 13 Default, IP Settings with Internal DHCP Server Enabled

### IP Settings

#### IP Address



The default Wireless Bolt LTE static IP address is **192.168.0.98**.

When you change the IP address:

1. Click **Save and Reboot** to reboot Wireless Bolt LTE.  
→ Wireless Bolt LTE reboots for the setting to take effect.
2. In your web browser, enter the new IP address and press **Enter**.  
→ The built-in web interface login screen appears.
3. Enter *Username* and *Password* and click **Sign in**.

#### Subnet Mask



The default subnet mask is **255.255.255.0**.

The subnet mask identifies the subnetwork to which the static IP address belongs.

### Internal DHCP Server



By default, the Wireless Bolt LTE internal DHCP server is enabled.  
To avoid interference, keep only one DHCP server enabled on the network.



*The DHCP server is only enabled on the LAN interface.*

By default, **Internal DHCP Server** is set to **Enabled**.

→ This means that the IP address settings are set automatically by the Wireless Bolt LTE internal DHCP server.

### IP Address Range



*When the Wireless Bolt LTE is enabled, you can still use static IP addresses within the remaining IP address range. The devices assigned to these IP addresses can set Wireless Bolt LTE as the default gateway and DNS server.*

The *internal DHCP server address* host ID range is by default set to start at 100 and stop at 200.

You can set a preferred host ID range.

## 5.8 Cellular Settings

When you are going to connect Wireless Bolt LTE to a cellular network, make sure that you have installed a SIM card in *Wireless Bolt LTE SIM card holder*.

Refer to [Installing SIM Card, p. 8](#).

### 5.8.1 Network Settings

#### About Preferred Network Type

By default, the **Preferred Network Type** is set to **Modem Preset List**.

The most recently registered network type takes precedence.

When a specific Preferred Network Type is selected and available, the Wireless Bolt LTE modem might remain locked to that network type, even if you switch to Modem Preset List.

Solution: If the Wireless Bolt LTE modem is locked to a network type you do not want to use, ensure that the network type is no longer available to the Wireless Bolt LTE. The Wireless Bolt LTE modem then selects the next available network type.

#### Procedure

On the **Cellular Settings** page:

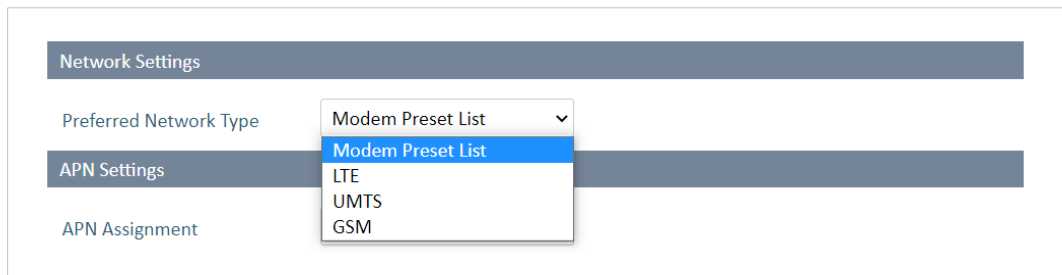

Fig. 14

1. Select a Preferred Network Type:

Setting	Description
Modem Preset List	Use the Modem Preset List search order for Radio Access Technology (RAT). Connects automatically to an available network according to following priority order LTE, UMTS and GSM mobile network. The Wireless Bolt LTE modem scans for all available Public Land Mobile Networks (PLMN) in each RAT.
LTE	Use LTE network.
UMTS	Use UMTS network.
GSM	Use GSM (2G) mobile network.

## 5.8.2 APN Settings

On the **Cellular Settings** page:

### Automatic APN Assignment



An APN automatically derived from SIM card identification may not give full access to the cellular network. Follow your network operator's guidelines.



By default, Wireless Bolt LTE is set to automatically search for the SIM card APN setting. If a general APN string is available for the network operator, it will be set as the APN Assignment.

Ensure that the general APN string is recommended by the network operator and in accordance with the SIM card IoT data plan.

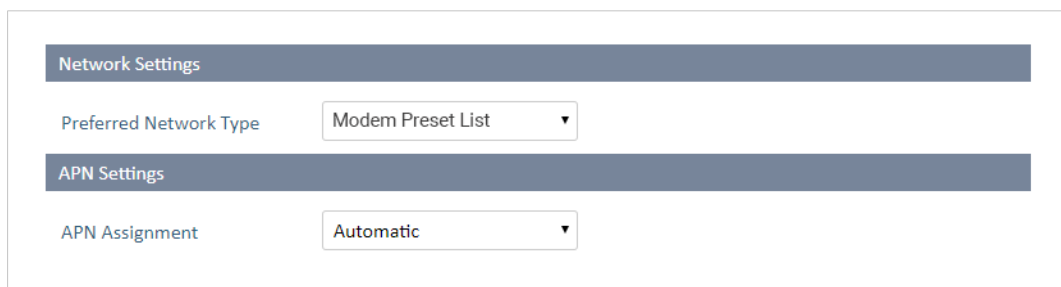

Fig. 15

The **APN Assignment** is by default set to **Automatic**.

→ The *APN* (Access Point Name) is assigned automatically.



### Manual APN Assignment

You can set the APN Assignment manually.

Ensure that you have the APN supplied by your carrier available.



**Fig. 16** APN example

1. Enter the *APN* in the **APN** field.

### APN Authentication

By default, **APN Authentication** is set to **No**. When enabled, PAP method is used.



**APN Authentication** is to be configured only if your carrier has setup APN (Access Point Name) with username and password.

Ensure that you have the APN username and password supplied by your carrier available.

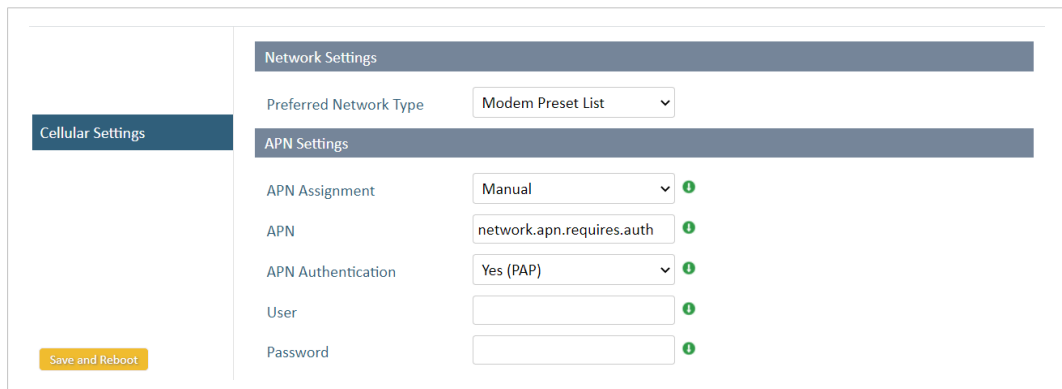

**Fig. 17**

To activate APN Authentication:

1. Set the **APN Authentication** setting to **Yes (PAP)**.
2. In the **User** field, enter a username.
3. In the **Password** field, enter a password.
4. In the left sidebar menu, click **Save and Reboot**.
  - Wireless Bolt LTE automatically reboots for the settings to take effect.

### 5.8.3 Lock Configuration

When configuration is locked, you can still access and use the Wireless Bolt LTE built-in web interface but the settings can not be configured.

On the **System** page:

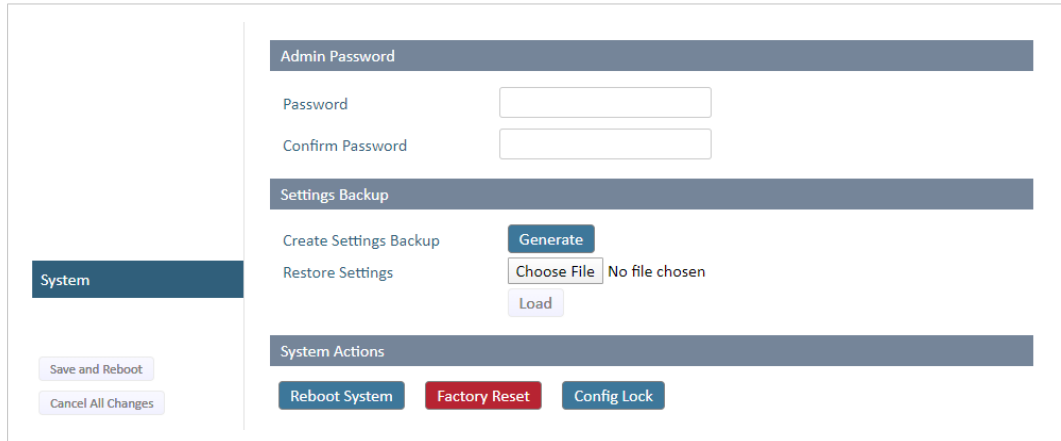

The screenshot shows the 'System' configuration page. On the left is a sidebar with 'System' selected. Below it are 'Save and Reboot' and 'Cancel All Changes' buttons. The main content area has three sections: 'Admin Password' with 'Password' and 'Confirm Password' input fields; 'Settings Backup' with 'Create Settings Backup' (Generate button) and 'Restore Settings' (Choose File button, No file chosen text, Load button); and 'System Actions' with 'Reboot System', 'Factory Reset', and 'Config Lock' buttons.

Fig. 18 Restore Settings from a backup file

To lock the configuration:

1. Click **Config Lock**.
2. To confirm lock configuration, click **OK**.

### 5.8.4 Unlock Configuration

To unlock configuration, do a factory reset using the Wireless Bolt LTE **Reset** button.

Refer to [Reset and Recovery, p. 43](#).

## 5.9 NAT/Port Forward Settings

NAT/Port forward is used to allow incoming traffic from an external (cellular mobile-radio) network access to a device IP address on the internal (Ethernet) network.

The Source Filter setting is used to prevent unauthorized traffic on the local network.

By default, Incoming Traffic **NAT 1:1** is set to **Disabled**. All incoming traffic from the external network is rejected.

### Procedure

On the **NAT/Port Forward Settings** page:

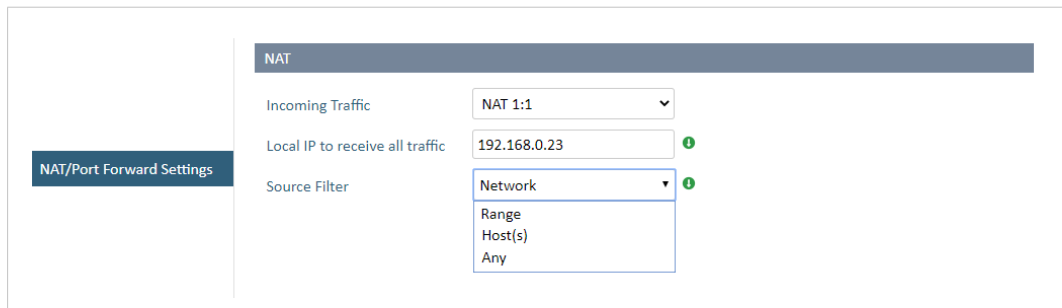

Fig. 19

To configure the NAT 1:1 settings:

1. In the **Incoming Traffic** drop down menu, select **NAT 1:1**.
2. In the **Local IP to receive all traffic** field, enter the IP address to receive all incoming traffic from the external network.
3. In the **Source Filter** drop down menu, select the desired source filter.

Source Filter adds a layer of security on the internal network.  
The source filter controls which IP addresses on the external network that have access to the Local IP address.

Source Filter	Description
Network	Default setting Allow any IP address on a specific network to access the Local IP address. Enter <b>Source base IP</b> and <b>Source IP netmask</b> .
Range	Allow a specific IP address range to access the Local IP address. Enter the <b>Source IP range start</b> and <b>Source IP range stop</b> addresses.
Host(s)	Allow a specific host(s) to access the Local IP address. Enter <b>Source IP(s)</b> . You can add up to five Source IP(s).
Any	Allow any external IP address to access the Local IP address.

### Result

- The communication is redirected to one specific device IP address on the local network, that will receive all incoming traffic from the external network.

## 5.10 Positioning Settings

Use the positioning function to locate the position of the Wireless Bolt LTE.

For example, to send the Wireless Bolt LTE position to an application via the REST API.

By default, Positioning Service is **Disabled**.

### Procedure

To activate Positioning Service:

1. On the Positioning Settings page, select **Enable** from the Positioning Service drop down menu.

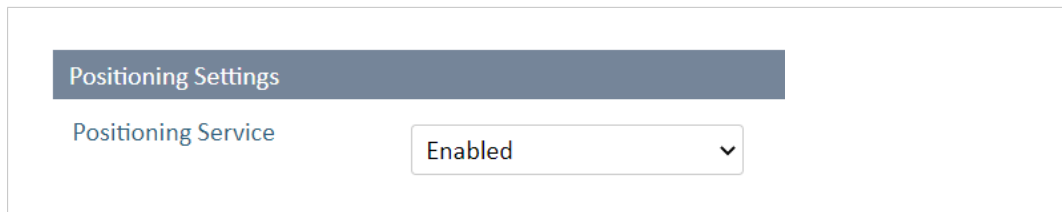

Fig. 20

2. In the left sidebar menu, click **Save and Reboot**.
  - Wireless Bolt LTE automatically reboots for the setting to take effect.

### Result

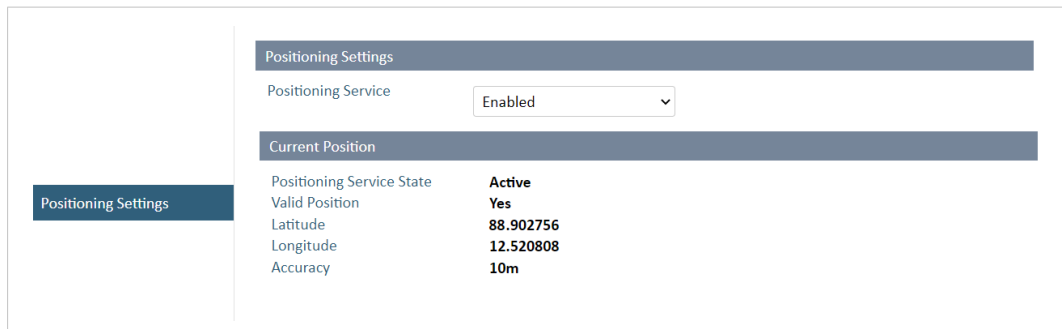

Fig. 21 Example, Current Position information

In Current Position you can view the following information.

Positioning Service State	When the Positioning Service is: <ul style="list-style-type: none"> <li>• Enabled the status is Active.</li> <li>• Disabled the status is Disabled.</li> </ul>
Valid Position	Yes: The satellite coverage is sufficient to provide a position. No: The satellite coverage is insufficient to provide a position. This can occur: <ul style="list-style-type: none"> <li>• at startup, before the Wireless Bolt LTE has found enough satellites to provide a position.</li> <li>• if the Wireless Bolt LTE is installed in a location where the satellite coverage is poor.</li> </ul>
Latitude	The latitude of the Wireless Bolt LTE current location
Longitude	The longitude of the Wireless Bolt LTE current location
Accuracy	The closeness of the measured location to the actual location of the Wireless Bolt LTE.

## 5.11 Setting Up with REST Commands

### 5.11.1 How To Use REST Commands

For information about the supported REST commands and how to use them, refer to the REST Commands Reference Guide at [www.anybus.com/support](http://www.anybus.com/support).

### 5.11.2 Use/Test REST Commands From a Web Browser

For information about the supported REST commands, refer to the REST Commands Reference Guide at [www.anybus.com/support](http://www.anybus.com/support).

#### Procedure

1. Setup the Wireless Bolt LTE as an internet router. Refer to [Setting Up Wireless Bolt LTE as an Internet Router, p. 28](#)

To send the REST command to the Wireless Bolt LTE:

2. Connect the Wireless Bolt LTE to your PC and log in to the Wireless Bolt LTE built-in web interface.
3. Open a new tab in your web browser.
4. Enter the desired command string in the **Address bar**.
5. To send the string, press **Enter**.

#### Result

- The command is sent to the *TCP port 80* on the Wireless Bolt LTE Ethernet interface.
- The Wireless Bolt LTE enters the state requested by the REST command.

#### Example 1: URL

```
http://192.168.0.99/cgi-bin/info.cgi
```

#### Example 2: Response

```
{"uptime":"338053","time":"1980-01-11 02:24:04",
"radio_power":"1","sim":"2","signal_strength":"4",
"signal_strength_raw":"22","signal_quality":"-10",
"cell_id":"26650646","operator":"Telavox","status":"1",
"amplifier_temp":"31","controller_temp":"31","connection_state":"2",
"voltage":"3868","iotbolt_version":"1.00.50-dev",
"modem_version":"SWI9X06Y_02.16.06.00","pri":"GENERIC_001.028_004",
"apn":"online.telia.se","rat_specific":"7","imsi":"240017431192642",
"imei":"352653090225053","cellular_gateway":"10.209.230.108",
"cellular_ip":"10.209.230.107","iccid":"89460100174311926424"}
```

## 6 Configuration Examples

### 6.1 Setting Up Wireless Bolt LTE as an Internet Router

Use Wireless Bolt LTE as an internet router to connect machines, controllers or other devices to internet.

#### Before You Begin

---

**i** *Wireless Bolt LTE comes with a default username and password.  
The default username is **admin**. Written in lowercase letters.  
You find the default password on the Wireless Bolt LTE product housing.*

---

**i** *Wireless Bolt LTE default IP address is **192.168.0.98**.*

---

To access the Wireless Bolt LTE built-in web interface, ensure that the Wireless Bolt LTE IP address and your PC IP address are within the same IP address range.

#### Procedure

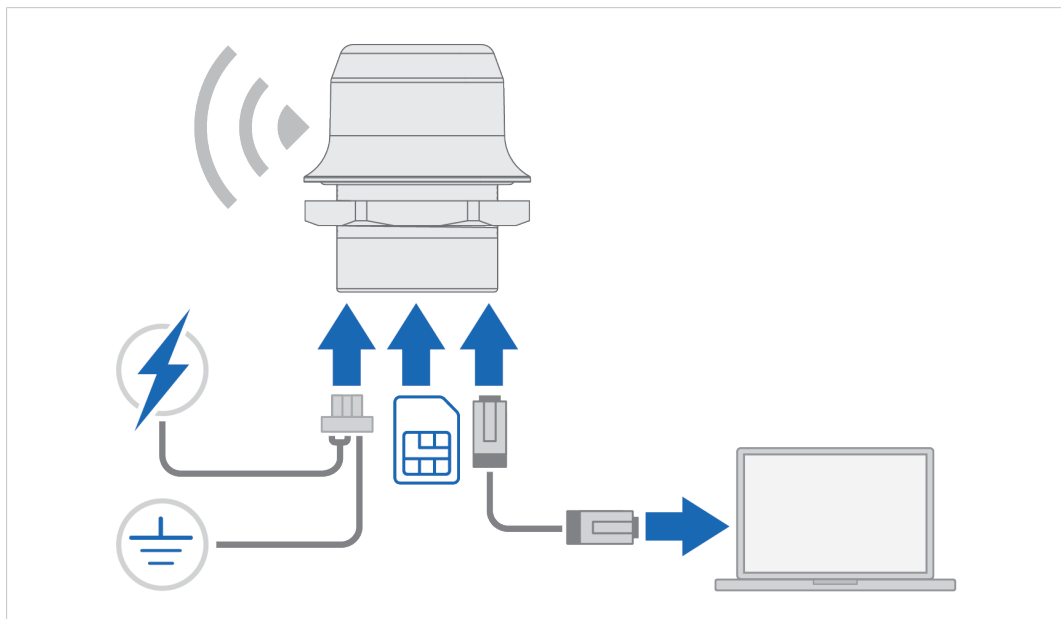

Fig. 22

Connecting Wireless Bolt LTE to internet:

1. Insert a *cellular SIM card* in the Wireless Bolt LTE *SIM card holder*.

---

**i** *Ensure that the SIM card contact surface is facing towards the Ethernet port.*

---

2. Connect the Wireless Bolt LTE *Ethernet port* to your PC.
3. Connect the Wireless Bolt LTE *Power connector* to a power supply.
4. To access the built-in web interface, enter the Wireless Bolt LTE IP address in your web browser and click Enter.
5. Login to the Wireless Bolt LTE built-in web interface.

6. Configure the **Ethernet Settings**, IP address and internal DHCP server settings.
7. Verify that the **APN Settings** are correct. You can adjust the settings manually.
8. In the left sidebar menu, click **Save and Reboot**.
  - Wireless Bolt LTE automatically reboots for the settings to take effect
9. On the **System Overview** page, verify that the cellular **Data Connection** has status **Yes**.

### Result

Wireless Bolt LTE should now be connected to internet.



*Depending on the mobile network operator and network type, it can take up to 10 minutes the first time Wireless Bolt LTE is connecting to internet.*

Verify that Wireless Bolt LTE is connected to internet, by sending a ping to *Google Public DNS*.

1. On the **Diagnostics** page, select the **Ping** method.
2. In the **Target** field, enter the IP address *8.8.8.8*.
3. To **Perform Action**, click **Start**.
  - The ping request is sent.
  - When the ping response return, a message appears.

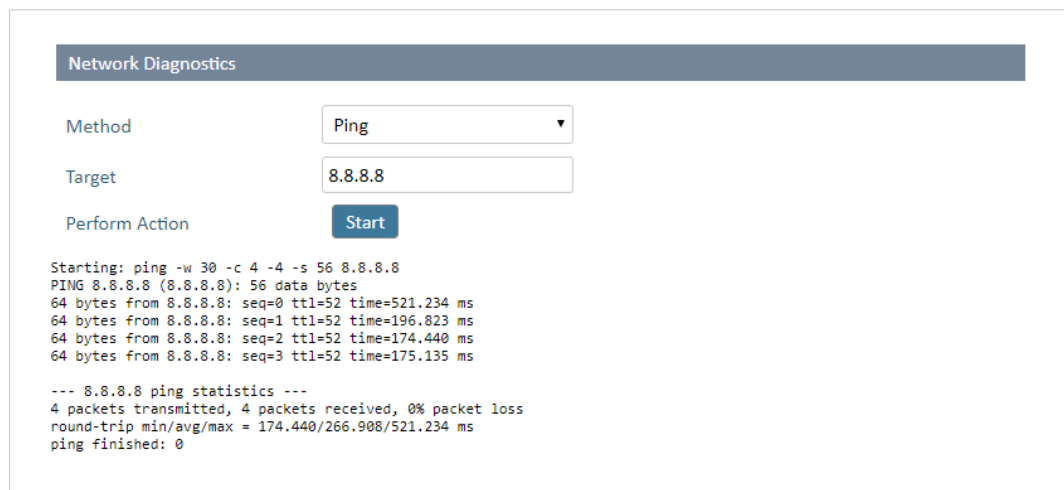

**Fig. 23** Example, Ping response message from Target 8.8.8.8

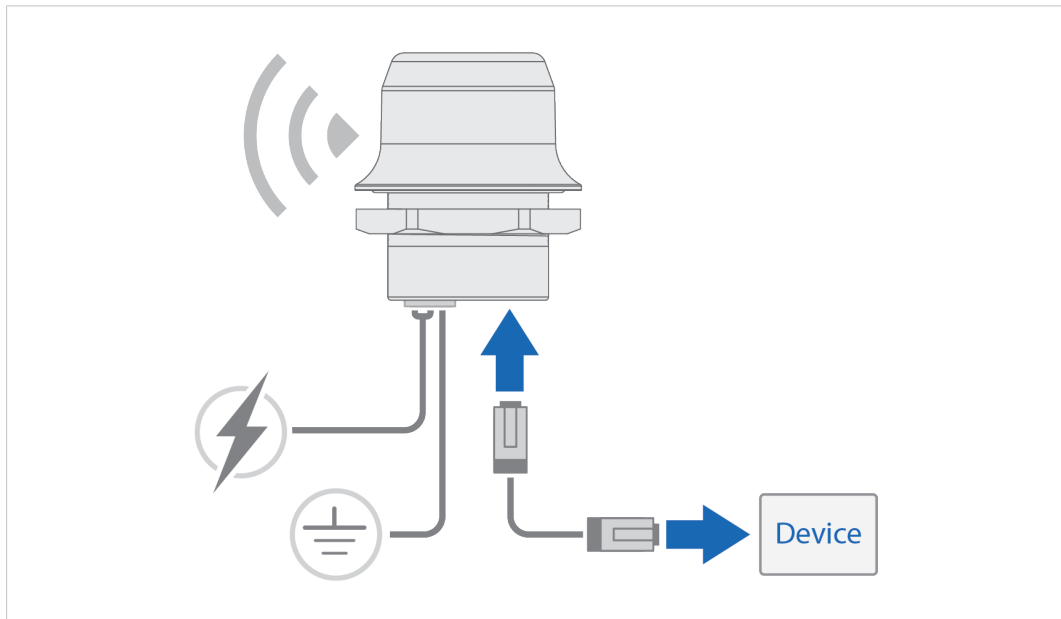
**Connecting Devices****Fig. 24**

Connecting a device to internet:

1. Connect an Ethernet cable between Wireless Bolt LTE and the device.
2. Verify that the device is connected to internet.



## 6.2 Setting Up Wireless Bolt LTE with ULPM REST Command



*The Wireless Bolt LTE variant for the US market does not support the ULPM REST Command.*

You can use Wireless Bolt LTE as an internet router with Ultra Low Power Mode (ULPM) to save electrical energy.

Devices using other power sources than grid connected power, such as devices powered by batteries and/or solar panels, benefit from using ULPM.

### Before You Begin

Setup Wireless Bolt LTE as an internet router, refer to [Setting Up Wireless Bolt LTE as an Internet Router, p. 28](#).

### Procedure

To put the Wireless Bolt LTE in ULPM for a specified duration:

1. Connect the Wireless Bolt LTE to your PC.
2. Open a web browser.
3. Enter the *ULPM command* together with the desired *ULPM sleep time* string in the **Address bar**.
4. To send the string, press **Enter**.

### Result

- The command is sent to the *TCP port 80* on the Wireless Bolt LTE Ethernet interface.
- The Wireless Bolt LTE enters ULPM and wakes up after the specified time has elapsed.



*A power cycle will cancel ULPM. When power is restored, the ULPM command must be re-sent for the Wireless Bolt LTE to re-enter ULPM.*

### Example 3: Enter ULPM and sleep for 300 seconds (5 minutes)

```
Query: http://192.168.0.98/cgi-bin/ulpm.cgi?duration=300
Response: {"success":true,"message":"sleeping for 300 s"}
```

For more information about the REST commands, refer to [Use/Test REST Commands From a Web Browser, p. 27](#).

## 7 Verify Operation

### 7.1 System Settings and Network Connection

On the **System Overview** page, verify the settings and network connection status.

The screenshot displays the 'System Overview' page for an Anybus Wireless Bolt LTE™ device. The page is divided into a left sidebar with navigation options and a main content area with settings sections.

**System Overview Page Structure:**

- Header:** Anybus<sup>®</sup> BY HMS NETWORKS Wireless Bolt LTE™ and HMS logo.
- Left Sidebar (Navigation):**
  - System Overview (Selected)
  - Ethernet Settings
  - Cellular Settings
  - NAT/Port Forward Settings
  - Positioning Settings
  - Firmware Update
  - Logs
  - System
  - Diagnostics
  - Buttons: Save and Reboot, Cancel All Changes
- Main Content Area:**
  - Ethernet Section:**
    - Internal DHCP Server: **Enabled**
    - DHCP Table:**

IP Address	MAC Address
192.168.0.178	00:0a:75:18:aa:48
  - Cellular Section:**
    - Data Connection: **Yes**
    - Signal Strength: **Strong signal (4)**
    - Operator: **nor.net**
    - SIM Card: **SIM card inserted and unlocked**
    - Status: **Registered to a roaming network**
    - Network Type: **LTE network**
    - APN: **data.rewicom.net**
  - System Section:**
    - Firmware: **0.0.0-latest-dev**
    - Time (UTC): **2021-01-08 13:13:59**
    - Uptime: **2 hours 35 minutes 8 seconds**

Fig. 25 Example, Verify Settings and Network Connection

#### Data Connection

Data Connection status **Yes** is picked up from the underlying system and is not tested for data transfer.

The Wireless Bolt LTE modem may get a control connection, but once data is sent the connection is terminated immediately.

This can be caused by discrepancy between the selected network technology, the SIM card and the operator setting.

To troubleshoot the cause of the termination, analyze the **System Log**, refer to [Logs, p. 39](#).

If the problem recurs, contact your network operator.

## 7.2 Ethernet LED Status Indication

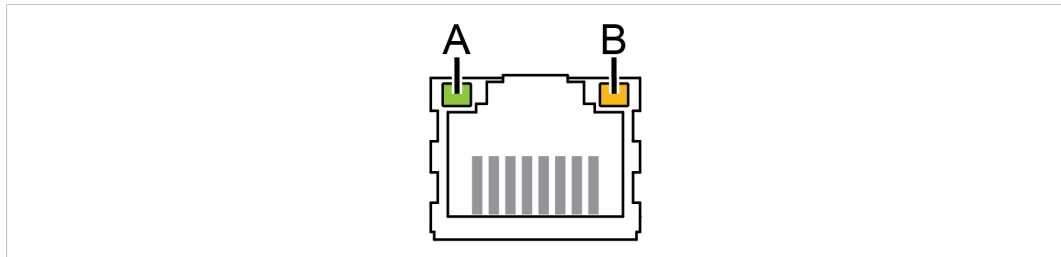



Fig. 26 RJ45 LED indicators

LED A – LINK/ACTIVITY	Function
Off	No Ethernet link
Yellow	10 Mb/s Ethernet link established
Yellow, flashing	10 Mb/s Ethernet activity
Green	100 Mb/s Ethernet link established
Green, flashing	100 Mb/s Ethernet activity
LED B – STATUS	Function
Off	No power
Blue	Connected on LTE
Purple	Connected on UMTS
Blue, slow blink	Connected on GSM.
Alternating blue/purple	Trying to connect
Red, slow blink	No configured cellular interface/no SIM card/no valid configuration
Red	Recoverable/unrecoverable fault
Yellow	Booting or sleep

## 8 Maintenance

### 8.1 Firmware Update

Update Wireless Bolt LTE firmware.

 *The configuration settings are not affected when updating firmware.*

- ▶ Download the *firmware update file* from [www.anybus.com/support](http://www.anybus.com/support).
- ▶ Connect Wireless Bolt LTE to your computer, refer to [Connecting to PC and Power, p. 14](#).

On the **Firmware Update** page:

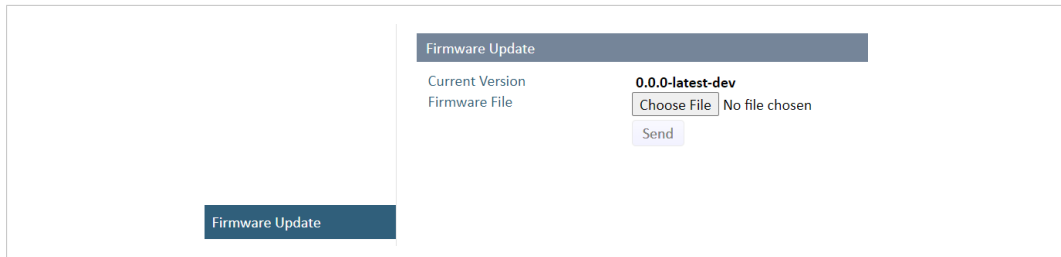
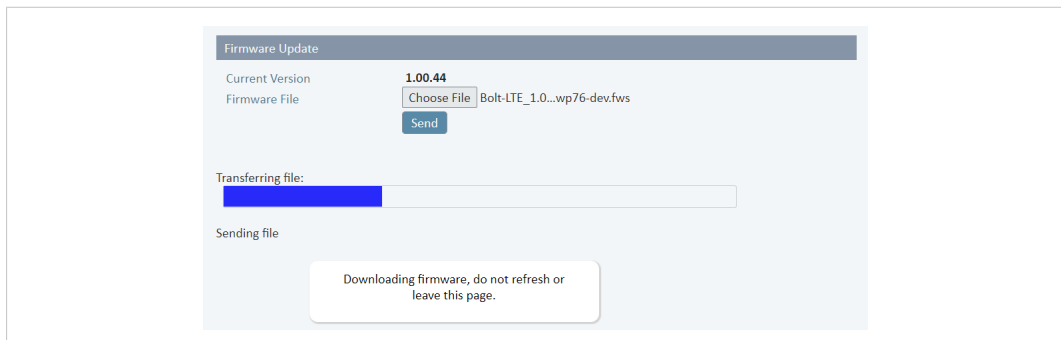

**Fig. 27** Firmware Update

1. Click **Choose File**.
2. In the **Open** dialog box, browse to and select the *firmware update file* and click **Open**.
3. To start the file transfer, click **Send**.

 *Do not refresh or leave the Firmware Update page until the process has finished.*

Firmware update:



**Fig. 28** Firmware Update

- The progress bar, Transferring file, indicates the progress of the file transfer.
- Status messages show the progress of the firmware update stages.
- When the file transfer is finished, the progress bar turns green.

## Reboot:

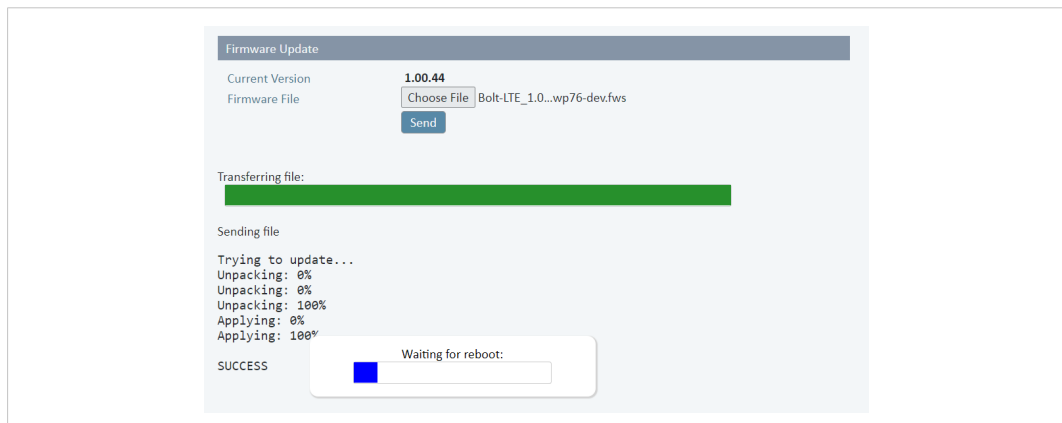

**Fig. 29** Firmware Update

→ When the firmware update is finished, Wireless Bolt LTE automatically reboots for the updates to take effect.

The progress bar, Waiting for reboot, indicates the progress.

→ When the reboot is complete, the web browser automatically redirects to the **System Overview** page.

## 8.2 Set Administrator Password



Before installing Wireless Bolt LTE on a network, change the default administrator password.



Wireless Bolt LTE comes with a default username and password.

The default username is **admin**. Written in lowercase letters.

You find the default password on the Wireless Bolt LTE product housing.

On the **System Settings** page, **Admin Password** pane:

The screenshot shows a web interface section titled "Admin Password". It contains two text input fields. The first is labeled "Password" and the second is labeled "Confirm Password".

Fig. 30 Set Admin Password

1. In the **Password** field, enter your preferred admin password.
2. To confirm the admin password, enter it in the **Confirm Password** field.
3. In the left sidebar menu, click **Save and Reboot**.
  - Wireless Bolt LTE restarts and you will be prompted to log in to the web interface with the new admin password.

## 8.3 Settings Backup

### 8.3.1 Create Settings Backup

On the **System** page:

The screenshot shows the "System" page in a web interface. On the left, a sidebar menu has "System" selected. Below the sidebar are "Save and Reboot" and "Cancel All Changes" buttons. The main content area has three sections: "Admin Password" (with "Password" and "Confirm Password" fields), "Settings Backup" (with "Create Settings Backup" containing a "Generate" button, and "Restore Settings" containing a "Choose File" button and "No file chosen" text), and "System Actions" (with "Reboot System", "Factory Reset", and "Config Lock" buttons).

Fig. 31 Generate backup file

Create a Settings Backup:

1. To save the current configuration in a *backup file*, click **Generate**.
  - A *backup file* is automatically downloaded and saved in the **Downloads** folder on your PC.

### 8.3.2 Restore Settings



When you restore settings from a *backup file*, all the current settings are overwritten by the settings loaded from the *backup file*.

On the **System** page:

The screenshot shows the 'System' page interface. On the left, there is a sidebar with a 'System' menu item. Below it are two buttons: 'Save and Reboot' and 'Cancel All Changes'. The main content area is divided into three sections: 'Admin Password' with 'Password' and 'Confirm Password' input fields; 'Settings Backup' with a 'Generate' button and a 'Restore Settings' section containing a 'Choose File' button (with 'No file chosen' text) and a 'Load' button; and 'System Actions' with three buttons: 'Reboot System', 'Factory Reset', and 'Config Lock'.

Fig. 32 Restore Settings from a backup file

Restore settings from a *backup file*:

1. Click **Choose file**.
  2. Browse to and select your *backup file*
  3. Click **Load**.
- Wireless Bolt LTE reboot automatically, for the settings loaded from the *backup file* to take effect.

## 8.4 Reboot System

On the **System** page:

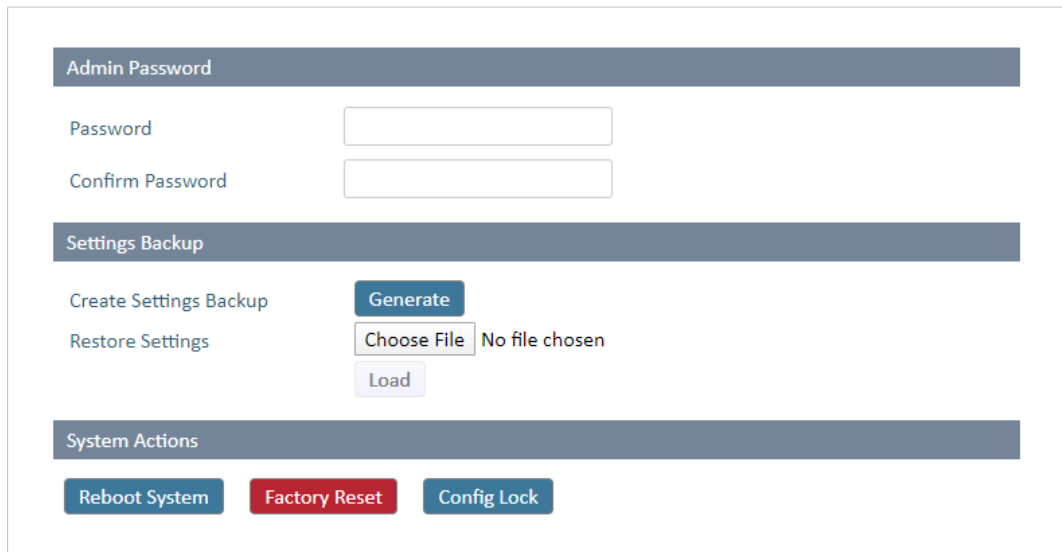

The screenshot displays the 'System' page interface. It is organized into three main sections, each with a dark blue header bar:

- Admin Password:** Contains two text input fields labeled 'Password' and 'Confirm Password'.
- Settings Backup:** Contains a 'Create Settings Backup' button labeled 'Generate', a 'Restore Settings' button labeled 'Choose File' (with 'No file chosen' text to its right), and a 'Load' button.
- System Actions:** Contains three buttons: 'Reboot System' (blue), 'Factory Reset' (red), and 'Config Lock' (blue).

**Fig. 33** Reboot System

1. If you have made any changes to the settings, you are prompted to click:
  - **Save**, to save the settings.
  - **Cancel**, to reboot the system without applying changes.
2. To reboot the system, press **Reboot System**.



# 9 Troubleshooting

## 9.1 Logs

The System Log contain useful information for troubleshooting issues that may occur in the system.

The Log file contains additional information, such as messages from the kernel, drivers, init scripts, services and applications (not originating from HMS).



*Before contacting support for assistance, it is suggested that you save the System Log file and then add it as an attachment when you create the support ticket.*

On the **Logs** page:

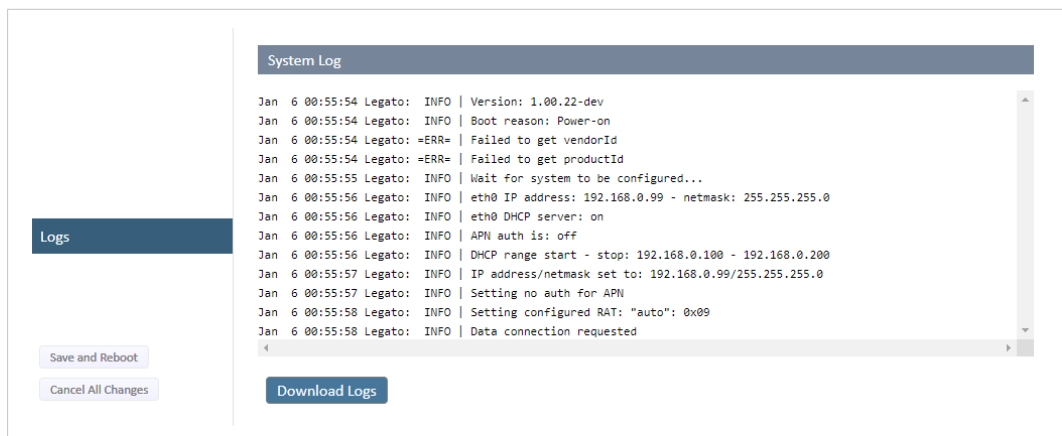

**Fig. 34** Logs

- To download current full system log and, if present, two previous boots logs, click **Download Logs**.  
 → A GNU zip (.gz) file is automatically downloaded and saved in the **Downloads** folder on your PC.

## 9.2 Diagnostics

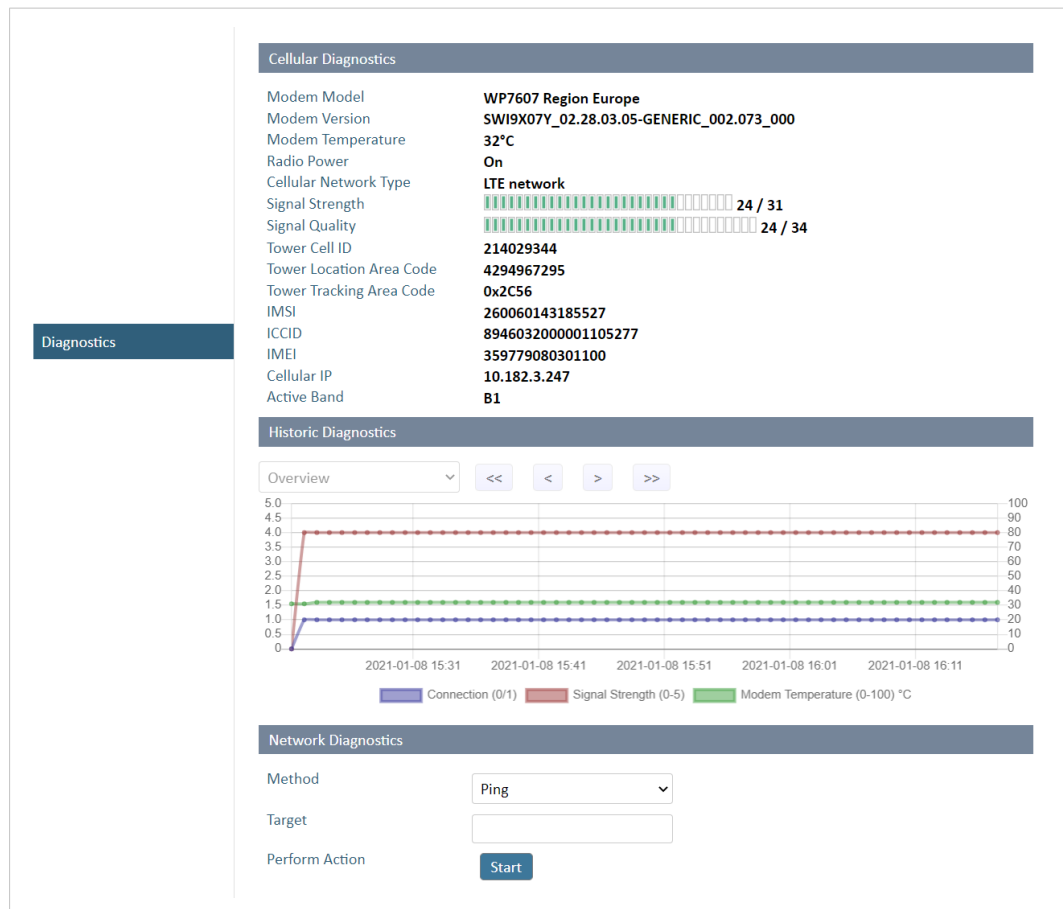

Fig. 35 Diagnostics

### 9.2.1 Cellular Diagnostics

#### Monitor Signal Strength and Quality

You can use the diagnostics information when planning the installation of Wireless Bolt LTE.

If Wireless Bolt LTE are going to be placed in a fixed installation and there are several possible locations to choose between, it is viable to monitor the signal strength and quality in the intended locations.

#### View Mobile Network Information

Cellular diagnostic information, such as Tower Cell ID, IMEI (International Mobile Equipment Identity) and ICCID (Integrated Circuit Card ID), is useful when you are in contact with your mobile network operator.

### 9.2.2 Historic Diagnostics

In the Historic Diagnostics you can overview the connection and signal strength over time in a diagram.

Select **Overview** or **Detailed** view.

### 9.2.3 Network Diagnostics

---

**i** *If Anybus Wireless Bolt LTE is installed on a private cellular network, the methods are limited according to the restrictions of the private network.*

---

**i** *The methods are useful when evaluating the connection on the cellular network. Complete the evaluation by performing tests from the connected device on the LAN network.*

---

**i** *To get reliable network diagnostics results, large amounts of data may be used. Before running the Wget method, check the SIM card data rate.*

---

The network diagnostics methods work for both modem devices and for LAN interface devices.

Perform a network diagnosis:

1. Select the **Method**.

Method	Description
Ping	<p>Ping sends a packet to the specified address and then waits for the response.</p> <p>Some devices do not expect longer round trip time, introduced by cellular network connection. Use ping to measure the <i>round trip time</i>. Ideally, measure towards the host that your device connects to, or another host at a similar distance. The host must be configured to respond to these types of requests. If errors exist, ping reports the errors.</p> <p>Ping can also show packet loss.</p> <p>If the host's IP address is known, start by pinging the host's IP address and then the host's DNS name. The DNS name is dependent on <i>name server lookup</i>.</p> <p>To verify that Wireless Bolt LTE is connected to internet, you can send a ping to <i>Google Public DNS</i>. In the <b>Target</b> field, enter the IP address (IPv4) <i>8.8.8.8</i> or <i>8.8.4.4</i>.</p>
Nslookup	<p>Nslookup is used to query <i>internet domain name servers</i>. When Nslookup is run, the IP address of the DNS server and the targeted host IP address are shown. The DNS server is usually specified by the network operator.</p>
Wget	<p>Retrieve files using HTTP. The retrieval can help you evaluate the real download capacity of the connection. The retrieved file is not saved to the Wireless Bolt LTE.</p>

2. Enter a **Target**.

3. To Perform Action, click **Start**.
  - The request is sent to the target.
  - When the target response returns, a message appears.

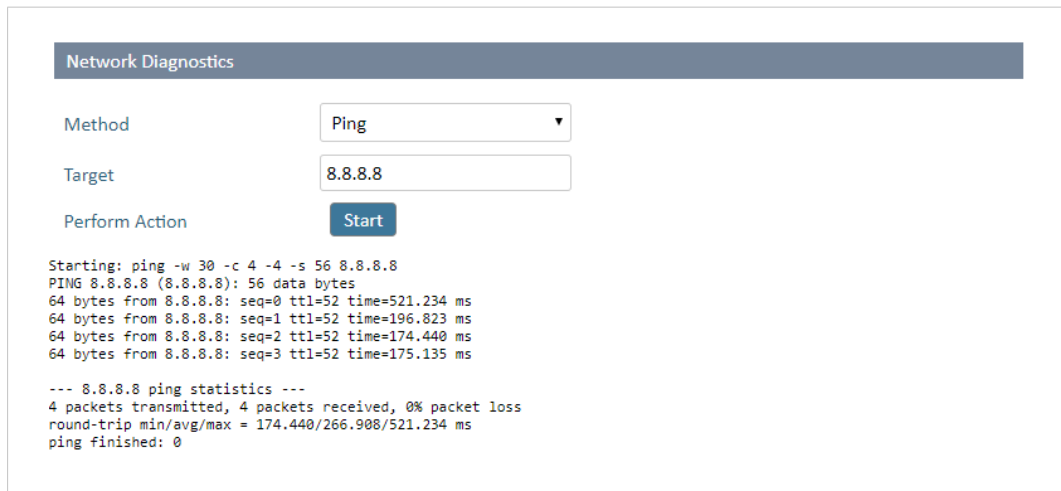

Fig. 36 Example, Ping response message from target 8.8.8.8

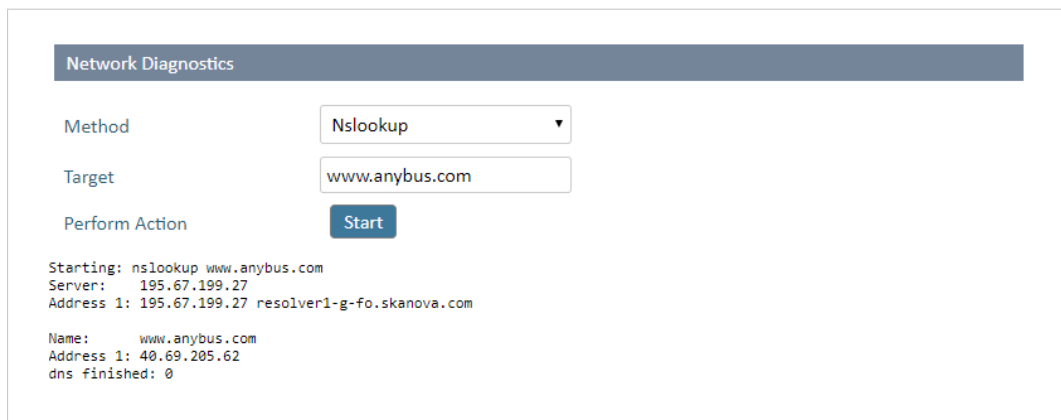

Fig. 37 Example, Nslookup response message from target www.anybus.com

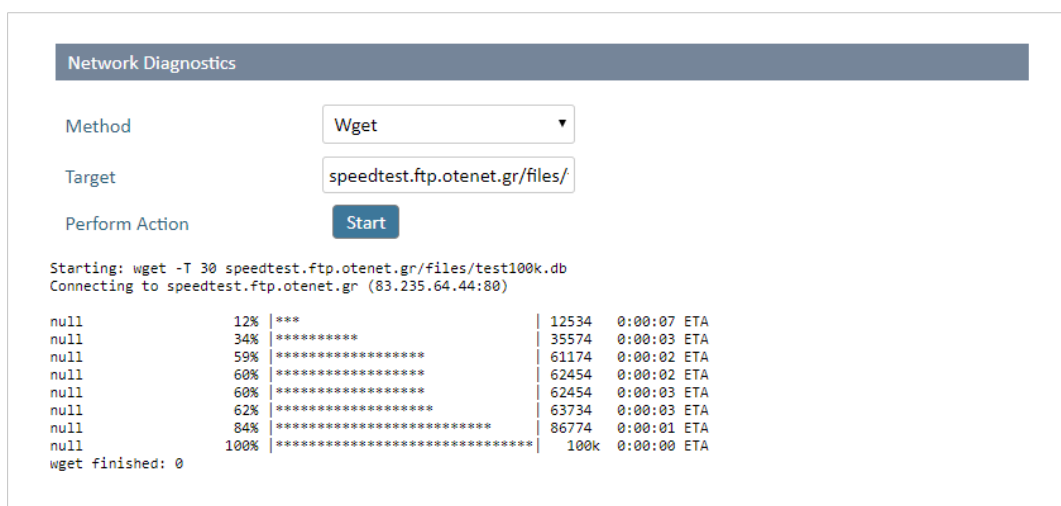

Fig. 38 Example, Wget response message from target Speedtest

## 9.3 Reset and Recovery

### 9.3.1 Reset Button

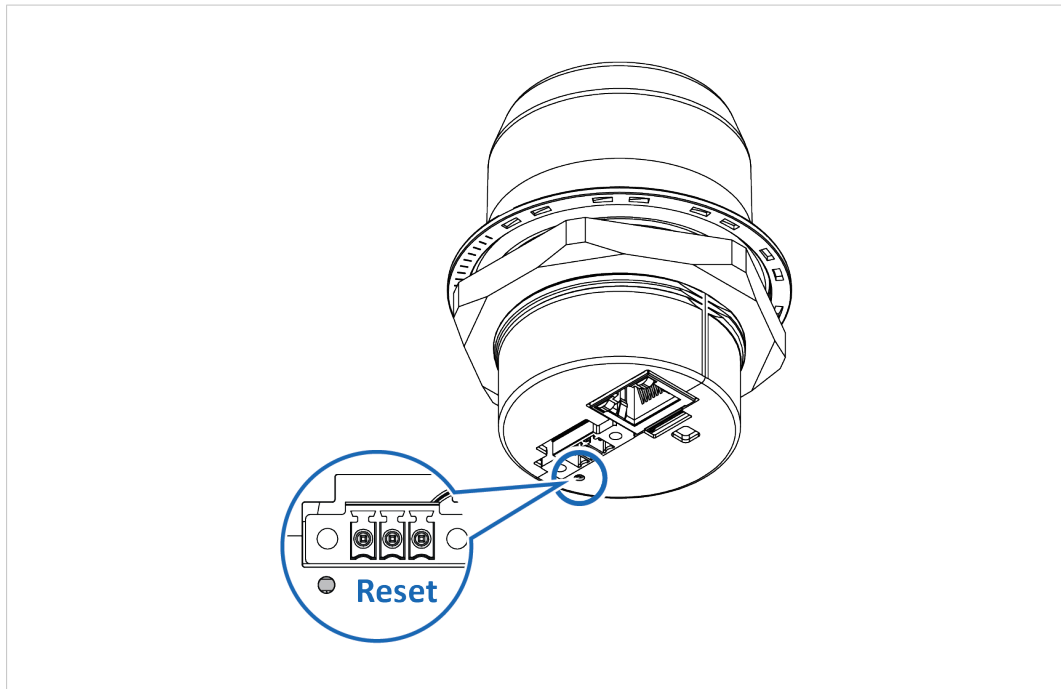

Fig. 39 Reset button

The **Reset** button is located on the bottom of the Wireless Bolt LTE.

### 9.3.2 Factory Reset



Factory Reset will result in the loss of all configuration settings and logs.

#### Factory Reset Using the Reset Button

1. Ensure that the Wireless Bolt LTE is powered on and running.
2. Use a pointed object (such as a ballpoint pen) to press and hold the **Reset** button for >10 seconds and then release it.

#### Result

→ Wireless Bolt LTE is reset to the factory default settings.

### Factory Reset Using the Web Interface

On the **System** page:

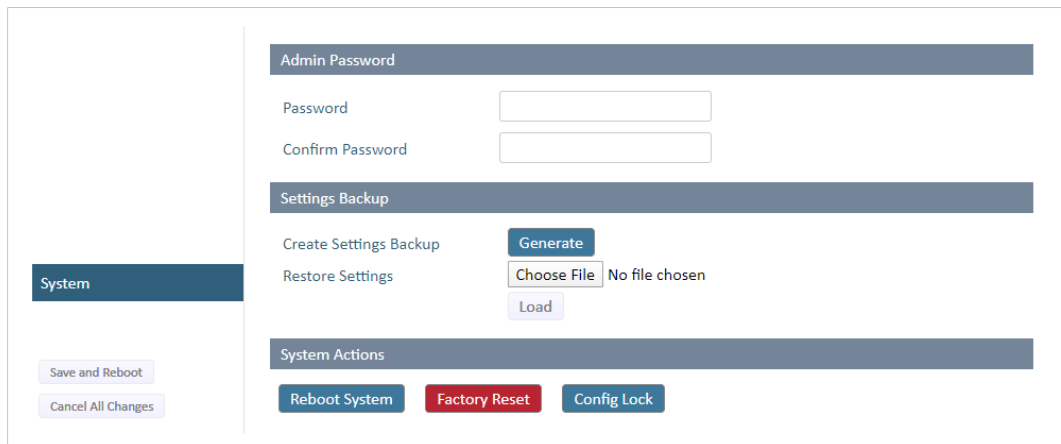

**Fig. 40** Factory Reset

1. Click **Factory Reset**.
2. To confirm factory reset, click **OK**.

#### Result

→ Wireless Bolt LTE is reset to the factory default settings.

# 10 Technical Data

## 10.1 Technical Specifications

<b>Order code</b>	<b>EMEA: AWB1500</b> <b>Americas: AWB1502</b>	<b>EMEA: AWB1501</b> <b>Americas: AWB1503</b>
<b>Color</b>	Black	White top and black base
<b>Operating temperature</b>	Shadow: -40 to +65 °C Direct sunlight: -40 to +45 °C	Shadow: -40 to +65 °C Direct sunlight: -40 to +65 °C
<b>Host interface</b>	RJ45 Ethernet 10/100 Mbit/s, PoE	
<b>Storage temperature</b>	-40 to +85 °C	
<b>Humidity compability</b>	EN 600068-2-78: Damp heat, +40 °C, 90% (non-condensing).	
<b>Vibration</b>	Refer to datasheet at <a href="http://www.anybus.com/support">www.anybus.com/support</a> .	
<b>Dimensions</b>	Diameter: 68 mm. Height: 75 mm without Power connector, 84 mm incl. Power connector. Height above mounting surface: 41 mm.	
<b>Weight</b>	100 g	
<b>Housing material</b>	Plastic (see datasheet for details)	
<b>Protection class</b>	Top (outside of host): IP66 and IP67 / UL Type 4X Base (inside of host): IP21	
<b>Mounting</b>	M50 screw and nut (50.5 mm hole needed)	
<b>Power</b>	3-pin screw connector and PoE (Power over Ethernet) 11-33 VDC through Power connector, PoE, IEEE 802.3at Type 1 (Class 0, 37-57 VDC, max 12.95 W) Redundant or separate operation of PoE and DC connectors.  Power Consumption: Sleep Mode: Power connector 0.1 W. PoE 0.3 W Idle Mode: Power connector 0.6 W. PoE 0.8 W Worst Case average power: Power connector 3.2 W. PoE 3.6 W. Worst case peak current: 1.2A@11VDC	
<b>Cellular standards</b>	EMEA: LTE B1, B3, B7, B8, B20, B28. Fallback 3G and 2G Americas: LTE B2, B4, B5, B12, B13, B14, B25, B26, B66. Fallback 3G.	
<b>Maximum Data speeds</b>	Max download speed: 100 Mbit/s Max upload speed: 50 Mbit/s	
<b>Ethernet protocols</b>	Transparent transfer of any TCP/UDP based protocol, Built-in firewall, NAT and DHCP server.	
<b>Certifications</b>	Refer to datasheet at <a href="http://www.anybus.com/support">www.anybus.com/support</a> .	