

AWM40000 SERIES

008345
Issue 2

Airflow Sensors, Amplified, and Unamplified

DESCRIPTION

The AWM40000 Series Airflow Sensors are based on proven microbridge technology and include both unamplified sensor-only devices and amplified signal conditioned devices.

The microbridge mass airflow sensor operates on the theory of heat transfer. Mass airflow is directed across the surface of the sensing elements. Output voltage varies in proportion to the mass air or other gas flow through the inlet and outlet ports of the package.

This sensor has a unique silicon chip based on advanced microstructure technology. It consists of a thin film, thermally-isolated bridge structure containing heater, and temperature sensing elements. The bridge structure provides a sensitive and fast response to the flow of air or other gas over the chip. Dual sensing elements positioned on both sides of a central heating element indicate flow direction as well as flow rate.

The specially-designed housing precisely directs and controls the airflow across the microstructure sensing element. Mechanical design of the package allows it to be easily mounted to printed circuit boards.

Laser-trimmed, thick film and thin film resistors provide consistent interchangeability from one device to the next. The microbridge mass airflow sensor uses temperature sensitive resistors deposited within a thin film of silicon nitride. They are suspended in the form of two bridges over an etched cavity in the silicon.

The chip is located in a precisely dimensioned airflow channel to provide a repeatable flow response. Highly effective, thermal isolation for the heater and sensing resistors is attained by etching the cavity space beneath the flow sensor bridges.

The small size and thermal isolation of the microbridge mass airflow sensor are responsible for the extremely fast response and high sensitivity to flows. Dual Wheatstone bridges control airflow measurement—one provides closed loop heater control, the other contains the dual sensing elements.

The heater circuit minimizes shift due to ambient temperature changes by providing an output proportional to mass flow. The circuit keeps the heater temperature at a constant differential (160°C) above ambient air temperature which is sensed by a heat-sunk resistor on the chip. The ratiometric voltage output of the device corresponds to the differential voltage across the Wheatstone bridge circuit.

The unamplified versions require both the heater control circuit (Fig. 2) and the sensing bridge supply circuit (Fig. 3) for operation per specification. These two circuits are not on board the sensor and must be supplied in the application. The differential amplifier circuitry (Fig. 4) may be useful in providing output gain and/or introducing voltage offsets to the sensor output (Fig. 5).

The amplified versions can be used to increase output gain and introduce voltage offsets. The circuits shown in Figs. 2, 3, and 4 are all provided onboard.

POTENTIAL APPLICATIONS

- **Medical**
 - Respirators and ventilators
 - Oxygen concentrators and conservers
 - Anesthesia machines
- **Industrial**
 - HVAC damper control
 - Gas analyzers
 - Low vacuum control
 - Process control
 - Leak detection equipment
 - Vent hoods
 - Gas metering
 - Chromatography

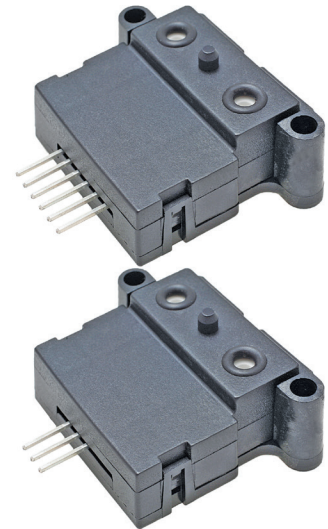

FEATURES

- Precision silicon micromachining
- Sensitivity to low flows (0.1 SCCM to 6 SLPM)
- Adaptable for use with higher flows
- Low power consumption allows for use in portable devices and battery-powered applications
- Analog output
- Standard 2,54 mm [0.10 in] mounting centers
- Laser-trimmed interchangeability
- Accurate sensing of low pressure



To view the entire mass airflow product portfolio, [click here.](#)

Honeywell

AIRFLOW SENSORS, AMPLIFIED, AND UNAMPLIFIED

AWM40000 SERIES

TABLE 1. SPECIFICATIONS

CHARACTERISTIC	UNAMPLIFIED		AMPLIFIED	
	AWM42150VH	AWM42300V	AWM43300V	AWM43600V-2
Flow range (full scale) ¹	±30 SCCM	±1000 SCCM	+1000 SCCM	0 SLPM to 6 SLPM
Calibration gas	—	—	nitrogen	nitrogen
Recommended excitation voltage	10 ±0.01 Vdc	10 ±0.01 Vdc	10.000 ±0.010 Vdc	10.000 ±0.010 Vdc
Power supply:				
minimum	8.0 Vdc	8.0 Vdc	8.000 Vdc	10.000 Vdc
maximum	15.0 Vdc	15.0 Vdc	15.000 Vdc	15.000 Vdc
Power consumption	30 mW typ.	30 mW typ.	60 mW max.	75 mW max.
Output at laser trim point	8.5 Vdc ±1.5 mVdc at 25 SCCM	55.2 Vdc ±2.0 mVdc at 1000 SCCM	5 Vdc ±0.15 Vdc at 1000 SCCM	5 Vdc ±0.15 Vdc at 6 SLPM
Null output	0 mV ±1 mV	0.0 mVdc ±1.5 mVdc	1.000 mVdc ±0.050 mVdc	1.000 Vdc ±0.050 Vdc
Null output shift (-25°C to 85°C)	±0.20 mVdc	±0.20 mVdc	±0.025 Vdc max.	±50 mVdc max.
Output voltage shift:				
25°C to -25°C	+2.5% reading max.	+2.5% reading,max.	-5.0% reading max.	-7.0% reading max.
25°C to 85°C	-2.5% reading max.	-2.5% reading max.	+6.0% reading max.	+7.0% reading max.
Repeatability and hysteresis ¹	±0.35% FSO typ.	±0.50% reading typ.	±0.5% reading max.	±1.00% reading max.
Pressure drop at full scale	0.008 inH ₂ O typ.	1.02 inH ₂ O typ.	1.02 inH ₂ O typ.	8 inH ₂ O typ.
Response time ²	1.0 ms typ. 3.0 ms max.	1.0 ms typ. 3.0 ms max.	1.0 ms nom.	1.0 ms nom. 3.0 ms max.
Overpressure	17.2 bar [250 psi] max.	10.3 bar [150 psi]	10.3 bar [150 psi]	1.7 bar [25 psi]
Maximum flow pulse to prevent damage	5 SLPM/s	5 SLPM/s	5 SLPM/s	5 SLPM/s
Output load:				
NPN (sinking)	10 mA	10 mA	10 mA	10 mA source, 20 mA typ.
PNP (sourcing)	20 mA	20 mA	20 mA	
Operating temperature range	-25°C to 85°C [-13°F to 185°F]	-25°C to 85°C [-13°F to 185°F]	-25°C to 85°C [-13°F to 185°F]	-25°C to 85°C [-13°F to 185°F]
Storage temperature range	-40°C to 125°C [-40°F to 251°F]	-40°C to 125°C [-40°F to 251°F]	-40°C to 90°C [-40°F to 194°F]	-40°C to 125°C [-40°F to 251°F]
Ratiometricity error	±0.30% reading	±0.3% reading	±0.3% reading nom.	±0.8% reading max.
Shock (5 drops, 6 axes)	100 g peak	100 g peak	100 g peak	100 g peak
Weight	17.5 g [0.62 oz] ³	—	—	11 g [0.39 oz]

¹Output voltage is ratiometric to supply voltage.

²Repeatability and hysteresis tolerances reflect inherent inaccuracies of the measurement equipment.

³Includes 4.3 g for backing plate.

AIRFLOW SENSORS, AMPLIFIED, AND UNAMPLIFIED

AWM40000 SERIES

TABLE 2. OUTPUT FLOW VS. INTERCHANGEABILITY (AT 10.0 ±0.01 VDC AT 25°C [77°F])¹

AWM42150VH				AWM42300V				AWM43300V				AWM43600V-2			
Pressure (ubar)	Flow (SCCM)	Nom. (mV)	Tolerance (±mV)	Pressure (mbar)	Flow (SCCM)	Nom. (mVdc)	Tolerance (±mVdc)	Pressure (mbar)	Flow (SCCM)	Nom. (Vdc)	Tolerance (±Vdc)	Pressure (mbar)	Flow (SLPM)	Nom. (Vdc)	Tolerance (±Vdc)
20	30	9.9	1.5	—	1000	55.2	2.0	2.23	1000	5.000	0.15	20.0	6	5.00	0.15
17	25	8.5	1.5	—	800	53.0	2.0	1.87	900	4.970	0.16	14.7	5	4.89	0.20
14	20	6.8	1.5	—	600	49.3	2.5	1.52	800	4.885	0.17	9.07	4	4.65	0.25
10	15	5.2	1.0	—	400	42.5	3.5	1.16	700	4.775	0.18	6.40	3	4.35	0.40
7	10	3.5	1.0	—	200	29.8	4.0	0.94	600	4.630	0.19	3.35	2	3.75	0.55
3	5	1.7	1.0	—	0	0	1.5	0.71	500	4.430	0.20	11.7	1	2.90	0.50
0	0	0.0	1.0	—	200	-29.8	4.0	-0.50	400	4.155	0.21	00.0	0	1.00	0.05
—	—	—	—	—	-400	-42.5	5.0	-0.33	300	3.760	0.19	—	—	—	—
—	—	—	—	—	-600	-49.3	6.0	0.19	200	3.225	0.17	—	—	—	—
—	—	—	—	—	-800	-53.0	6.0	0.08	100	2.485	0.14	—	—	—	—
—	—	—	—	—	-1000	-55.2	6.0	0.00	0	1.000	0.05	—	—	—	—

¹Numbers in bold type indicate calibration type, mass flow, or differential pressure. Tolerance values apply to calibration type only.

FIGURE 1. PERFORMANCE CURVES

AWM42150VH

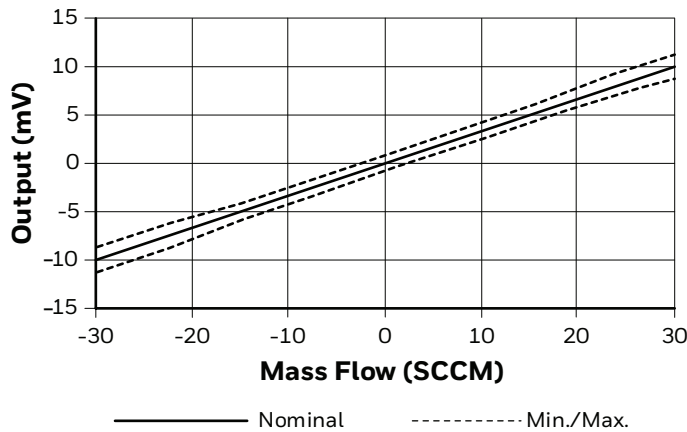

AWM42300V

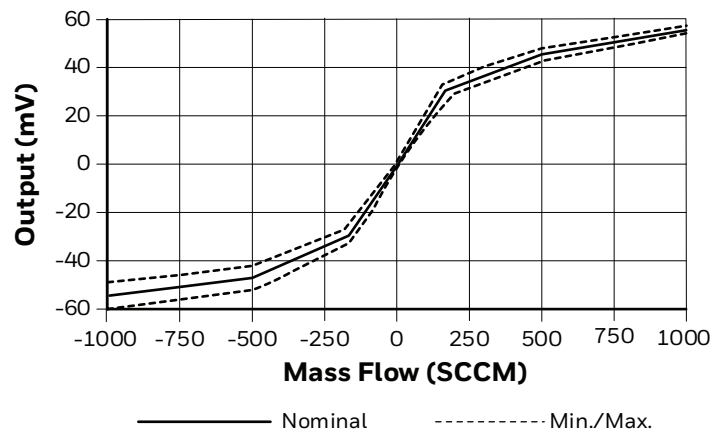

AWM43300V

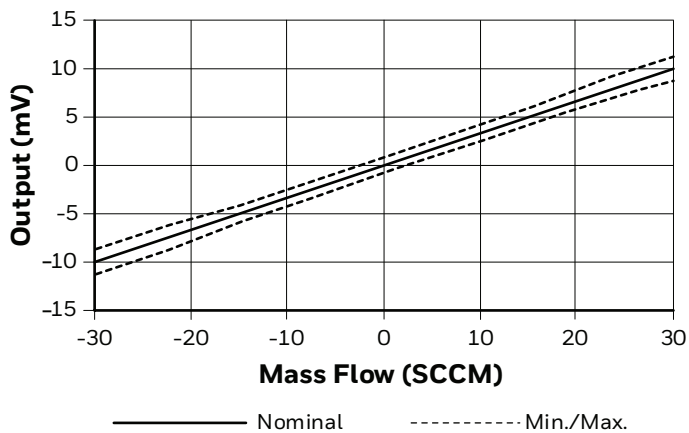

AWM43600V-2

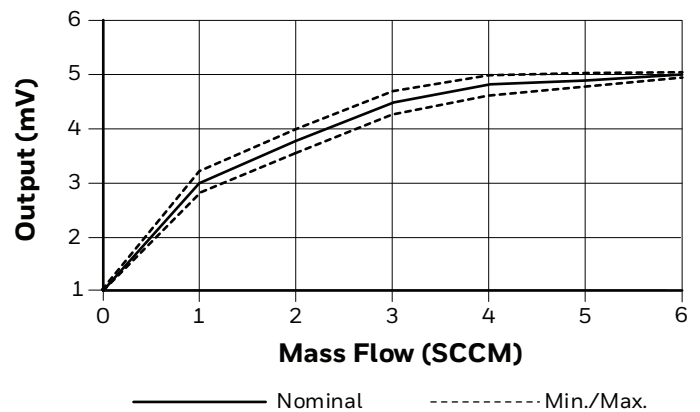

AIRFLOW SENSORS, AMPLIFIED, AND UNAMPLIFIED

AWM40000 SERIES

NOTICE

Both the Heater Control Circuit (Fig. 2) and the Sensing Bridge Supply Circuit (Fig 3.) are required for operation per specification when using the unamplified devices. These two circuits are not onboard the sensor and must be supplied in the applications.

FIGURE 2. HEATER CONTROL CIRCUIT

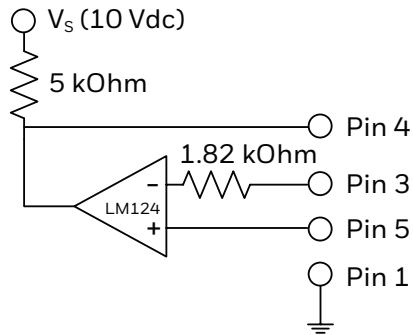
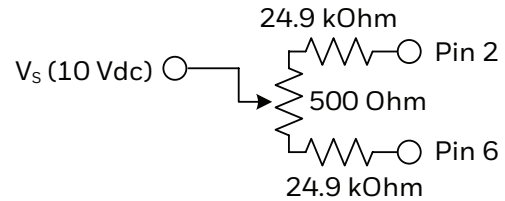

FIGURE 3. SENSING BRIDGE SUPPLY CIRCUIT



NOTICE

The differential amplifier circuitry in Fig. 4 may be useful in providing output gain and/or introducing voltage offsets to the sensor output (see Fig. 5) when using the unamplified devices.

FIGURE 4. DIFFERENTIAL INSTRUMENTATION AMPLIFIER CIRCUIT

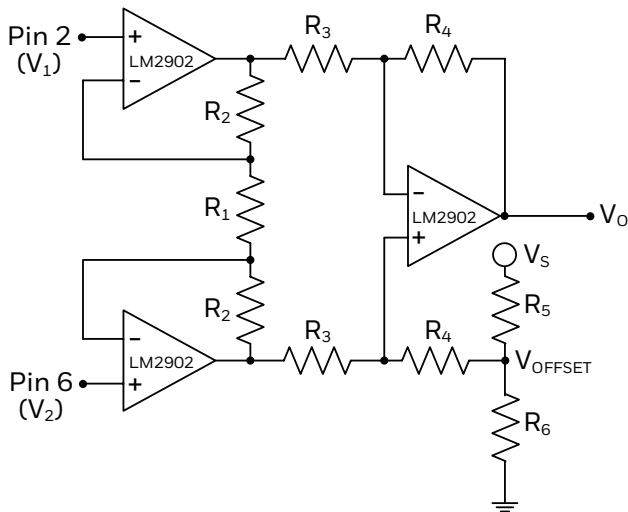

FIGURE 5. EQUATION

$$V_0 = \left(\frac{2R_2 + R_1}{R_1} \right) \left(\frac{R_4}{R_3} \right) (V_2 - V_1) + V_{\text{OFFSET}}$$

$$\text{where } V_{\text{OFFSET}} = V_S \left(\frac{R_6}{R_5 + R_6} \right)$$

AIRFLOW SENSORS, AMPLIFIED, AND UNAMPLIFIED

AWM40000 SERIES

CAUTION

PRODUCT DAMAGE

Do not use the AWM40000 Series to sense liquid flow.

Failure to comply with these instructions may result in product damage.

NOTICE

Positive flow direction is defined as proceeding from Port 1 (P1) to Port 2 (P2) and results in positive output.

NOTICE

The effects of dust contamination, which may result from some applications, can be minimized. By design, dust particles that may be present in the air stream will flow past the chip parallel to the chip surface. In addition, the microstructure chip produces a thermophoretic effect, which repels micrometer sized dust particles away from the bridge structure. A simple filter will prevent dust adherence to chip edges and channel surfaces. Adequate filtering in most applications can be achieved with a disposable five-micron filter used in series on the upstream side of the airflow device.

FIGURE 6. MOUNTING DIMENSIONS (FOR REFERENCE ONLY, MM/[IN])

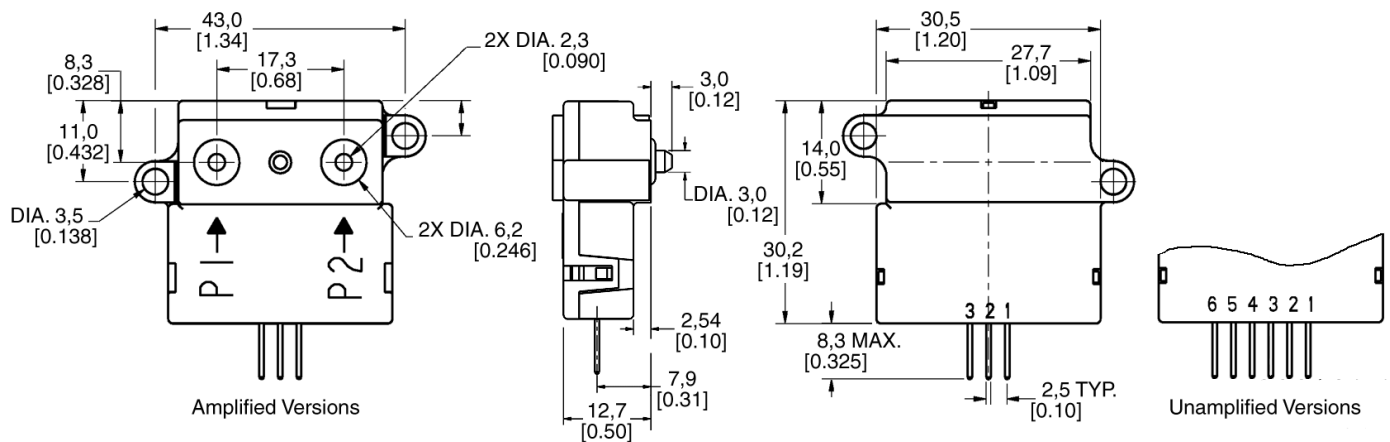

Pinout for amplified versions

- 1 = Output
- 2 = Supply
- 3 = Ground

Pinout for unamplified versions

See Figures 2, 3, and 4