

## B05S-HF Thru. B10S-HF

Reverse Voltage: 50 to 1000 Volts

Forward Current: 0.8 A

RoHS Device

Halogen Free

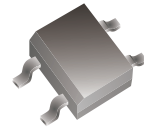

### Features

- Rating to 1000V PRV.
- Ideal for printed circuit board.
- Reliable low cost construction utilizing molded plastic technique results in inexpensive product.
- Pb free product.
- UL recognized file # E349301

### Mechanical data

- Polarity: Symbol molded on body.
- Weight: 0.125 grams.
- Mounting position: Any.

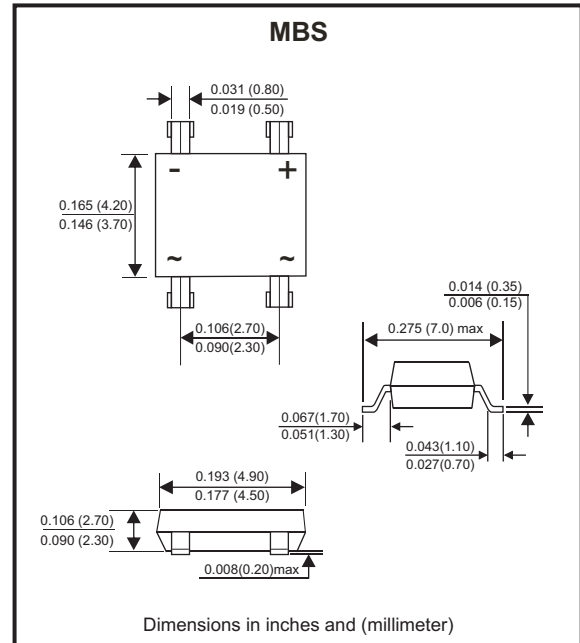

### Maximum Rating And Electrical Characteristics

Rating at  $T_A=25^{\circ}\text{C}$ , unless otherwise noted.  
 Single phase, half wave, 60Hz, resistive or inductive load.  
 For capacitive load, derate current by 20%.

Parameter	Symbol	B05S-HF	B1S-HF	B2S-HF	B4S-HF	B6S-HF	B8S-HF	B10S-HF	Unit
Maximum Recurrent Peak Reverse Voltage	$V_{RRM}$	50	100	200	400	600	800	1000	V
Maximum RMS Voltage	$V_{RMS}$	35	70	140	280	420	560	700	V
Maximum DC Blocking Voltage	$V_{DC}$	50	100	200	400	600	800	1000	V
Maximum Average Forward Rectified Current (Note 1) @ $T_A=40^{\circ}\text{C}$	$I_{(AV)}$	0.8							A
Peak Forward Surge Current, 8.3ms single half sine-wave, superimposed on rated load (JEDEC Method)	$I_{FSM}$	30							A
Peak Forward Voltage at 0.8A DC	$V_F$	1.1							V
Maximum DC Reverse Current at Rated DC Blocking Voltage @ $T_J=25^{\circ}\text{C}$ @ $T_J=125^{\circ}\text{C}$	$I_R$	5.0 500							$\mu\text{A}$
Typical Junction Capacitance per element (Note 2)	$C_J$	15							pF
Typical Thermal Resistance	Junction to ambient	$R_{\theta JA}$							$^{\circ}\text{C/W}$
	Junction to case	$R_{\theta JC}$							
Operating Temperature Range	$T_J$	-55 to +150							$^{\circ}\text{C}$
Storage Temperature Range	$T_{STG}$	-55 to +150							$^{\circ}\text{C}$

Notes: 1. Mounted on P.C. Board.  
 2. Measured at 1.0MHz and applied reverse voltage of 4V DC.

Company reserves the right to improve product design, functions and reliability without notice.

REV:C

## RATING AND CHARACTERISTIC CURVES (B05S-HF thru. B10S-HF)

Fig.1 - Forward Current Derating Curve

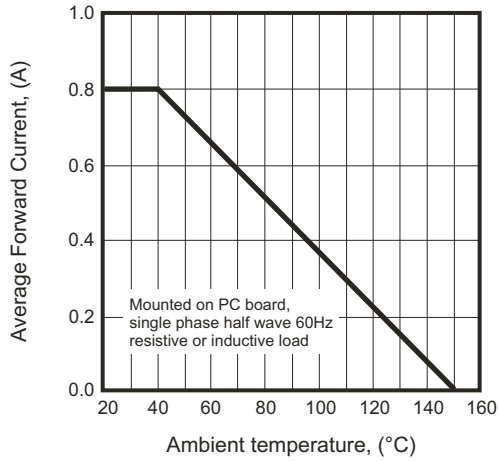

Fig.2 - Maximum Non-Repetitive Surge Current

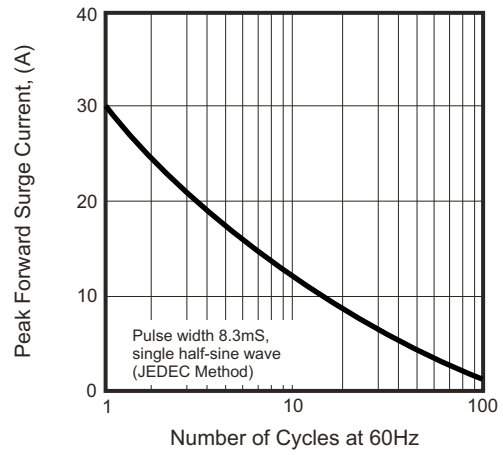

Fig.3 - Typical Reverse Characteristics

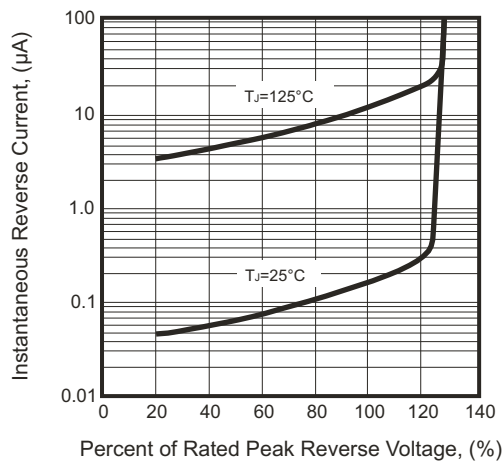

Fig.4 - Typical Forward Characteristics

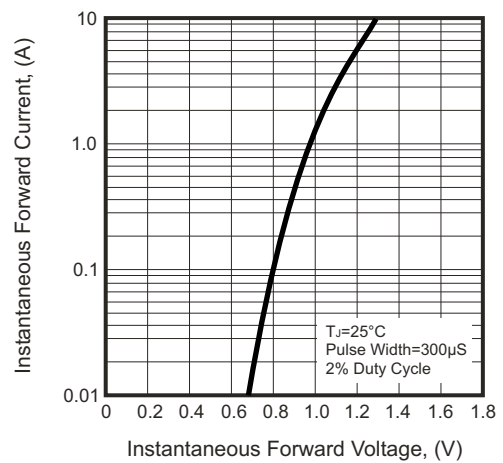
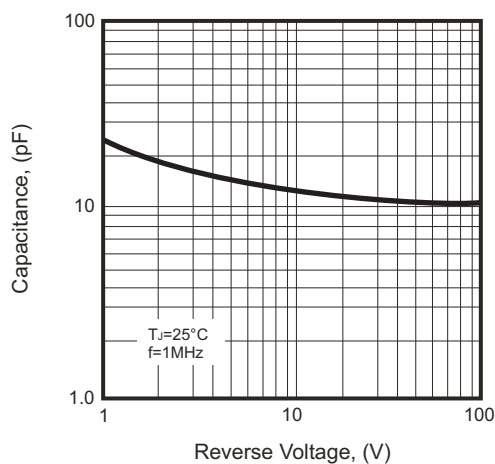
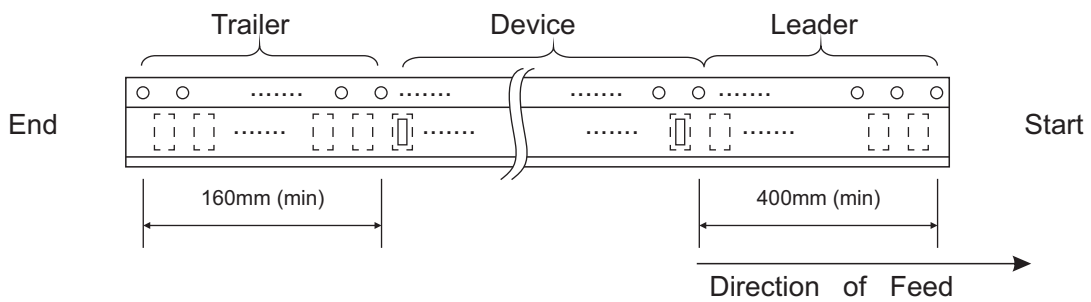
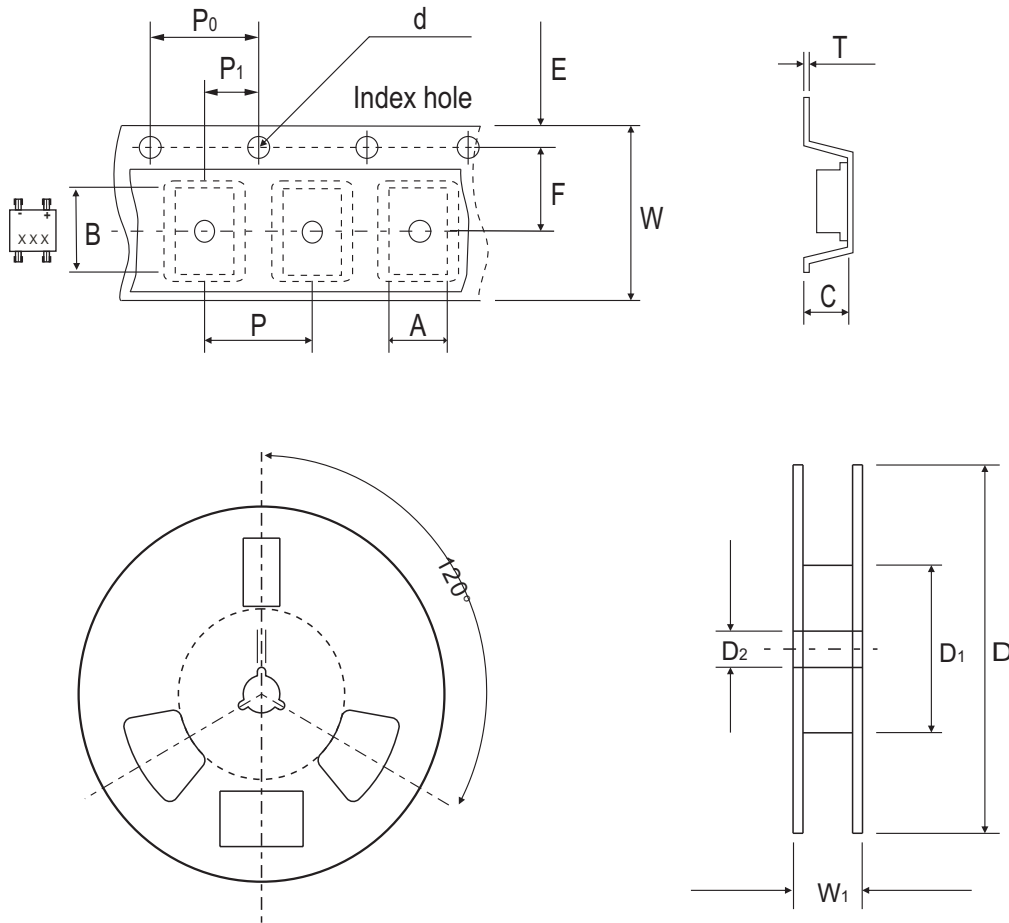

Fig.5 - Typical Junction Capacitance



Company reserves the right to improve product design, functions and reliability without notice.

## Reel Taping Specification



MBS	SYMBOL	A	B	C	d	D	D <sub>1</sub>	D <sub>2</sub>
	(mm)	4.90 ± 0.10	7.24 ± 0.10	3.33 ± 0.10	1.55 ± 0.05	330	50.0 MIN.	13.00 ± 0.20
	(inch)	0.193 ± 0.004	0.285 ± 0.004	0.131 ± 0.004	0.061 ± 0.002	13	1.969 MIN.	0.512 ± 0.008

MBS	SYMBOL	E	F	P	P <sub>0</sub>	P <sub>1</sub>	T	W	W <sub>1</sub>
	(mm)	1.75 ± 0.10	5.50 ± 0.05	8.00 ± 0.10	4.00 ± 0.10	2.00 ± 0.05	0.30	12.00 ± 0.30	12.00~14.40
	(inch)	0.069 ± 0.004	0.217 ± 0.002	0.315 ± 0.004	0.157 ± 0.004	0.079 ± 0.002	0.012	0.472 ± 0.012	0.472~0.657

Company reserves the right to improve product design, functions and reliability without notice.