

Microwave Products Catalog

RF Filters, Couplers, Power
Dividers and Custom RF Devices

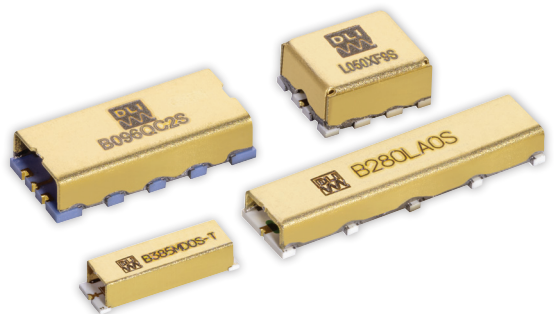
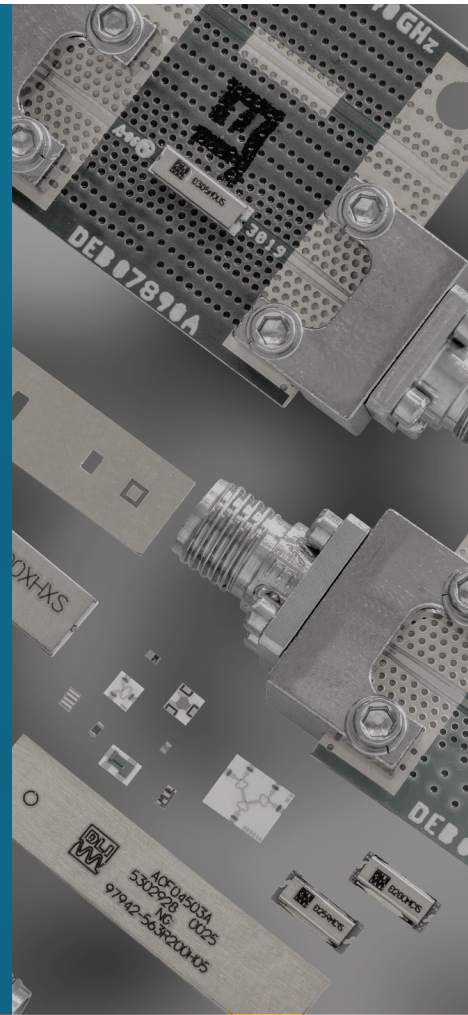

Table of Contents

DLI Brand Overview

3.....	Who We Are
4.....	Space Heritage
5.....	Microwave Products
6.....	Microwave Product Listing
7.....	Ceramic Advantages

Filter Product Listings

8.....	Microstrip Filter Overview
9.....	Filter Catalog Part Number Structure
10-17.....	Bandpass Filter Selection
18.....	High and Lowpass Filter Selection
19.....	How to Specify a Custom Filter
20.....	Cavity Filters
21.....	Ceramic Cavity Resonators

Custom Design Capabilities

22-23.....	Custom Devices
24.....	Build to Print Services and Substrates
25.....	Integrating RF Passives
26-27.....	Integrated R-C Networks

Device Product Listings

28-29.....	Power Dividers
30-31.....	Couplers
32-33.....	Gain Equalizers
34.....	5G Devices
35.....	5G Specialty Kits
36.....	SatCom Devices

User Guidelines

37.....	Chip and Wire Guide
38.....	Surface Mount Devices Guide
39.....	Reflow Process Guide
40.....	Quality and Environmental Policy

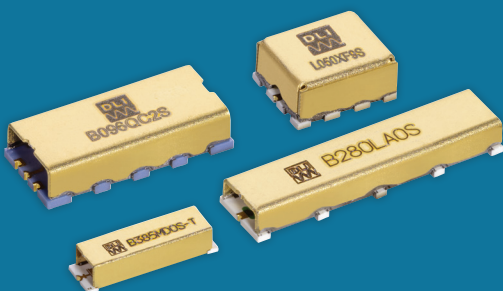

Who We Are

Knowles Precision Devices, a division of Knowles Corporation, focuses on production of a wide variety of highly engineered capacitors and microwave to mmWave components for use in critical applications in the military, medical, electric vehicle and 5G market segments. The company was formed by combining Dielectric Laboratories, Johanson Manufacturing, Novacap, Syfer and Voltronics, each well-established specialty capacitor makers with a combined history of over 200 years, into a single organization.

As a specialty components manufacturer, Knowles Precision Devices chooses to take on the complex challenges that come with high-reliability, high-temperature, high-performance, and high-frequency solutions. The Knowles Precision Devices DLI brand of technologies addresses the complex challenges of implementing high-performance mmWave filters.

Microwave Product Evolution Timeline

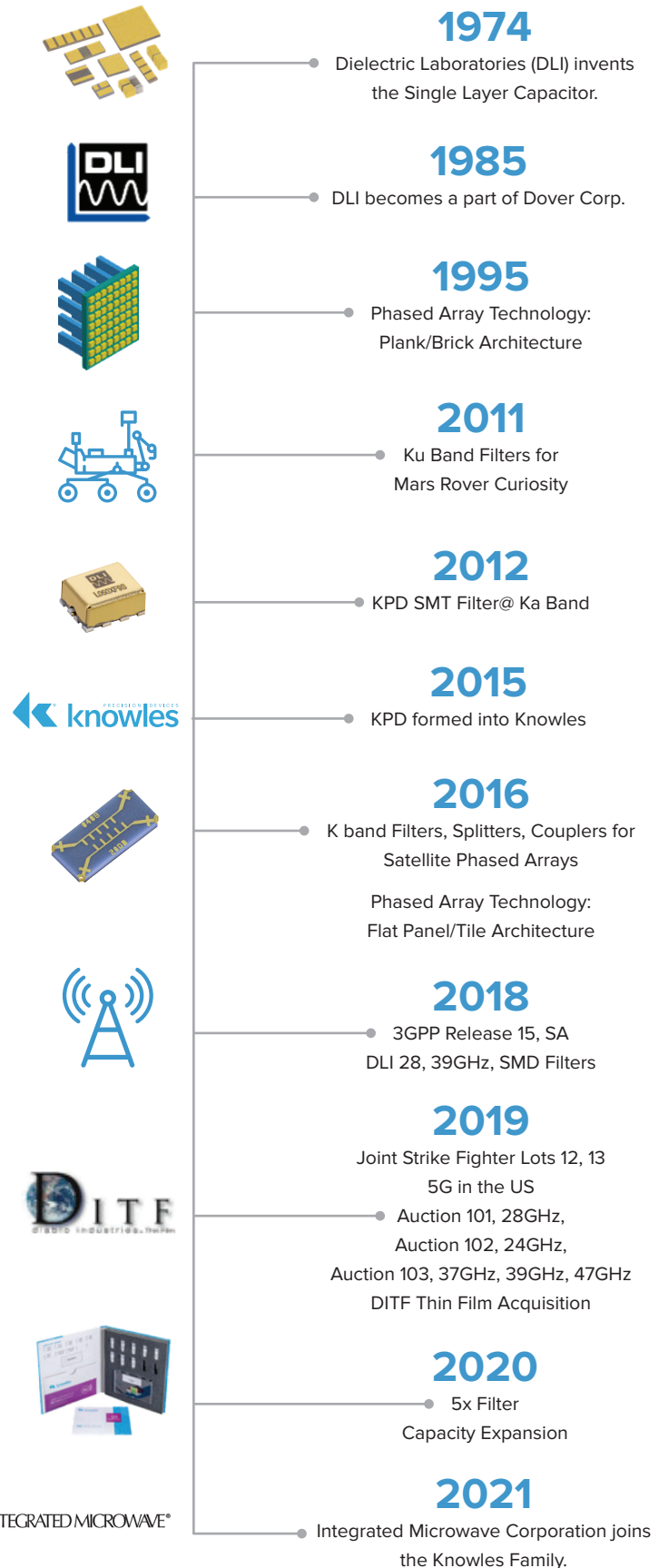

Space Heritage

Our products are currently used worldwide and in space — in the most advanced military and aerospace instrumentation and communication systems.

SPACE APPLICATIONS

2022	NISAR (NASA-ISO Synthetic Aperture Radar)
	NISAR TROPICS
2021	SWOT (Surface Water Ocean Topography)
	JPSS2 (Joint Polar Satellite System 2)
	New Glenn Blue Origin
2019	New Shepard Blue Origin
2017	JPSS1 (Joint Polar Satellite System 1)
2015	OG2 (Orbcomm Generation 2)
	MMS (Magnetosphere Multiscale Mission)
	SMAP (Soil Moisture Active Passive)
2014	WorldView-3
2013	MUOS (Mobile User Objective System)
2011	Suomi NPP (National Polar-orbiting Partnership)

2010	SBSS (Space Based Space Surveillance)
2009	WISE (Wide-field Infrared Survey Explorer)
	WorldView-2 LM-900
2008	GLAST (Gamma Ray Large Space Telescope)
2008	JEM-PM (Japanese Experimental Module “Kibo” Pressurized Module)
Various 2002 -	ATLAS Launch Vehicle
Ongoing 1998-	ISS (International Space Station)
	C2V2 (Common Communication for Visiting Vehicle)
	CONNECT
	IPP

MARS & JUPITER MISSIONS

2022	Europa Juice (Jupiter Icy Explorer)
	Europa RIME (Radar for Icy Moon Exploration)
2021	Orion
2018	InSight Lander (Interior exploration using Seismic Investigations, Geodesy and Heat Transport)
2016	ExoMars TGO (Trace Gas Orbiter)
2013	MAVEN (Mars Atmosphere and Volatile Evolution)
2011	Curiosity Sky Crane
	Curiosity Rover
2008	Phoenix Lander
2005	MRO (Mars Reconnaissance Orbiter)
2003	Opportunity Rover
	Spirit Rover

TESTING CAPABILITIES

RF PERFORMANCE TESTING

RF Performance GSG (ground signal ground)	100% or sample
RF Test Over Temperature	
Design Evaluation Boards	
Resistor Testing	100% or sample
TCR (Thermal Coefficient of Resistance)	MIL-STD-202, Method 304

ENVIRONMENTAL TESTING

Humidity	MIL-STD-202, Method 103
Immersion	MIL-STD-202, Method 104
Moisture Resistance	MIL-STD-202, Method 106
Thermal Shock	MIL-STD-202, Method 107
Temperature Cycling	MIL-STD-883, Method 1010

MECHANICAL TESTING

Constant Acceleration	MIL-STD-883, Method 2001
Mechanical Shock	MIL-STD-883, Method 2002
Solderability	MIL-STD-883, Method 2003
Visual	MIL-STD-883, Method 2008
External Visual	MIL-STD-883, Method 2009
Bond Strength	MIL-STD-883, Method 2011
Die Shear	MIL-STD-883, Method 2019
Ball Shear	ASTM 1269

PHYSICAL TESTING

Vibration	MIL-STD-202, Method 201
Resistance to Soldering Heat	MIL-STD-202, Method 210
Acceleration	MIL-STD-202, Method 212
DPA	EIA-469

Note: Standard test methods listed as capabilities. For each order, testing is carried out as specified by the customer on the SCD and PO.



Microwave Products

APPLICATIONS



Microwave Radar



Test Equipment



Switch Filter Banks

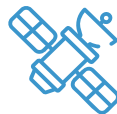

Satellite Communications



Telecom



Radio Communications



Synthesizers



5G Infrastructure



3GPP & mmWave

Custom is Standard for Us!
CHOOSE YOUR PATH TO SUCCESS...

Reach out to discuss your application with our engineering team:
DLEngineering@Knowles.com

CUSTOM THIN FILM DESIGN

Work with our design engineers to achieve customized performance similar to catalog selection

BUILD-TO-PRINT SERVICE

Supply your design to be manufactured with our specialized expertise

CATALOG PARTS COTS

A full selection of passive devices in this catalog, to fit varied industry needs
Also see catalogs for SLCs and MLCCs

For more info on customizing a solution, see pages #22-27

Microwave Product Listing

FREQUENCY 800MHZ TO 60+ GHZ

Do you need a custom order or a catalog part? We are here to help, email us DLengineering@knowles.com.

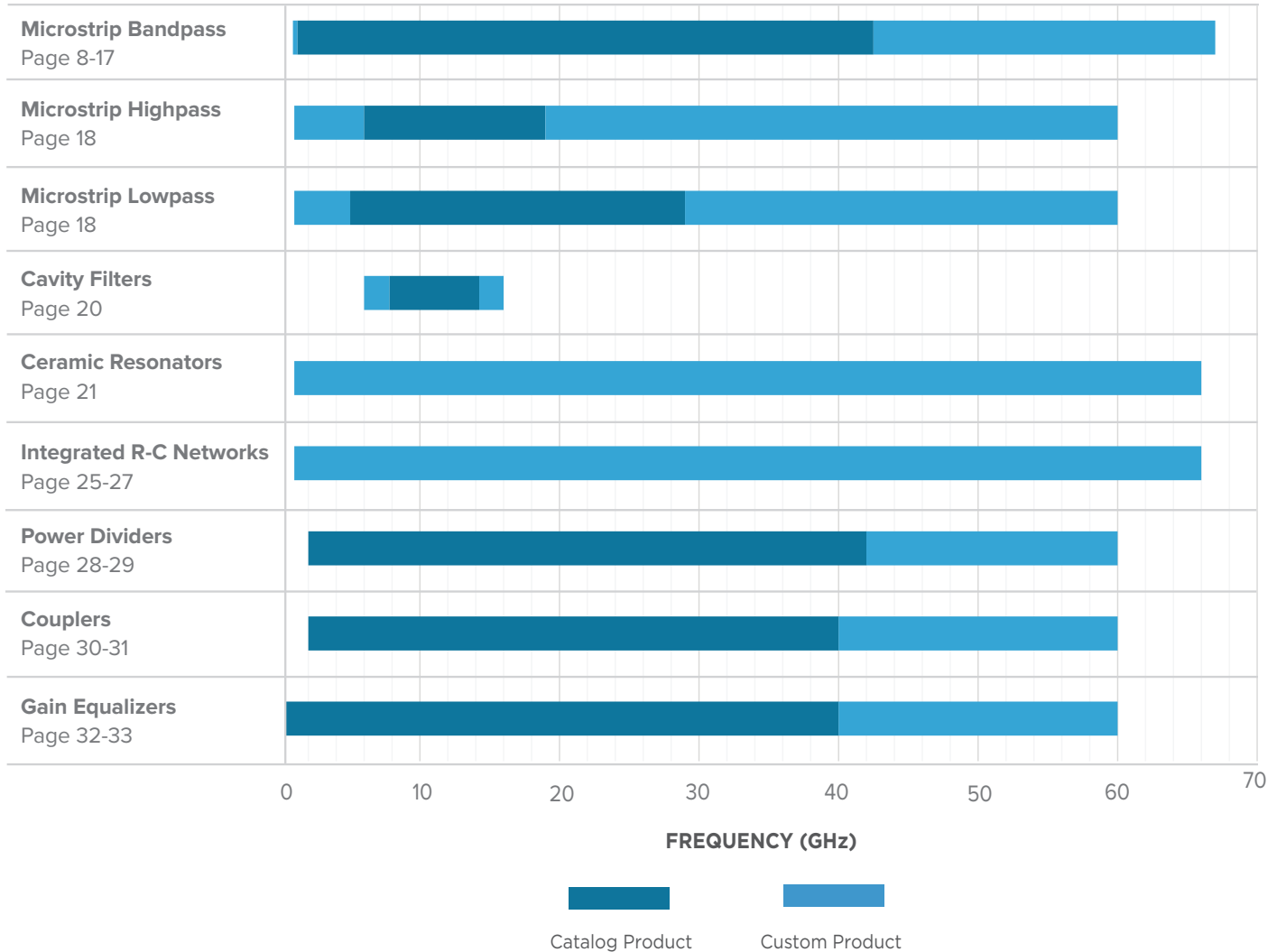

KEY FEATURES AND BENEFITS OF ALL OUR MICROWAVE PRODUCTS

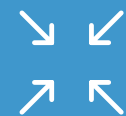

Small Size



Frequency Stable Over Temperature



Operating Temperature: -55°C to +125°C



Excellent Repeatability



Solder Surface Mount Package



Ceramic Advantages

Why do DLI brand parts have exceptional performance?

The specialized attributes of our ceramic substrate materials

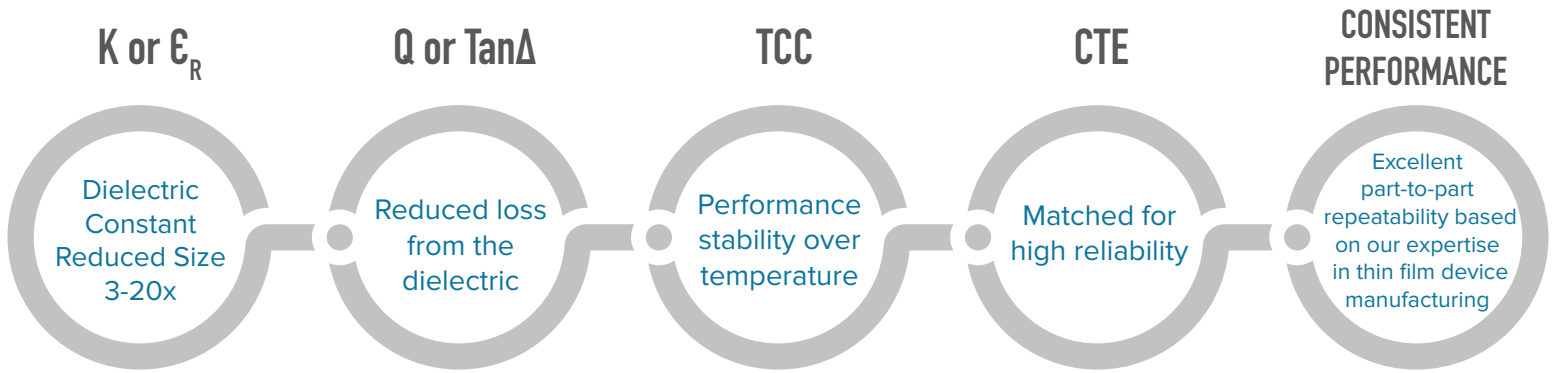

Relative Filter Size Compared by Material

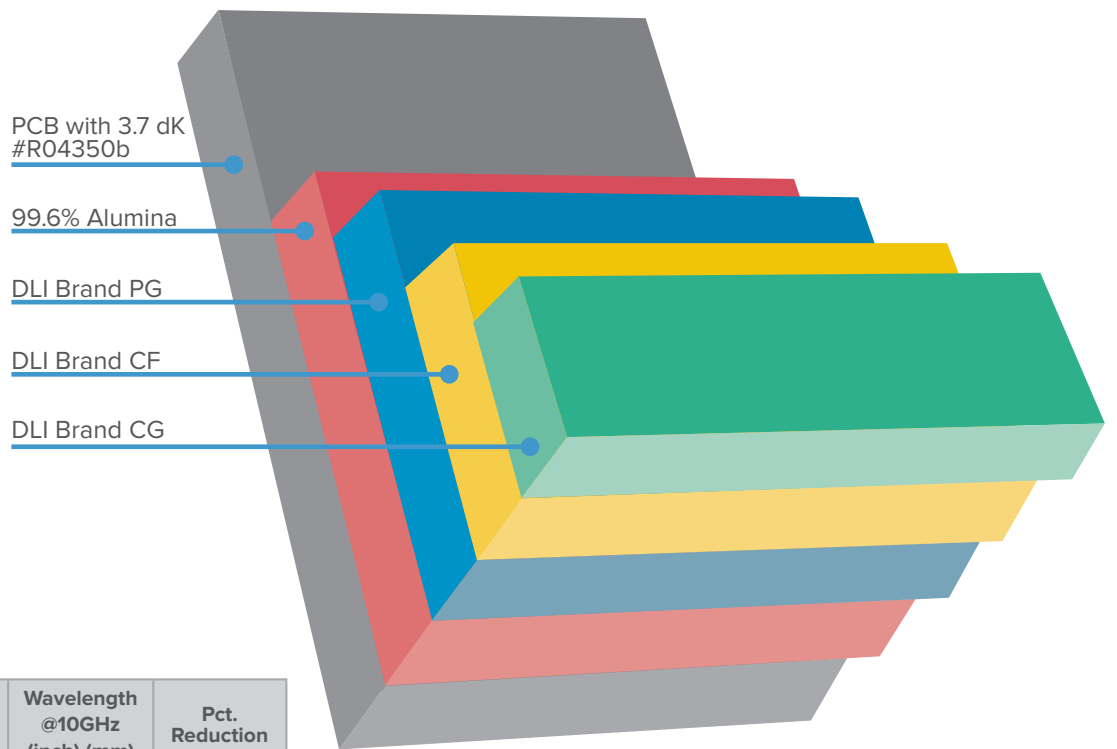

Filter Characteristics Compared by Material

Material	dK	Effective K**	Wavelength @10GHz (inch) (mm)	Pct. Reduction
PCB with Dk #R04350b	3.7	2.8	0.707 [17.96]	-----
99.6% Alumina	9.6	6.5	0.462 [11.73]	34.7%
DLI Brand PG	12.5	8.2	0.412 [10.46]	41.7%
DLI Brand CF	25	15.1	0.304 [7.72]	57.0%
DLI Brand CG	67	36.8	0.194 [4.93]	72.6%

**Values are for Freq. 10GHz on 0.010" Substrate



Microstrip Filter Overview

BANDPASS

DLI bandpass filters are designed for high-performance microwave applications in a surface mountable package. Using temperature-stable, high-permittivity dielectrics and thin-film processing, these designs offer high selectivity without sacrificing in-band performance.

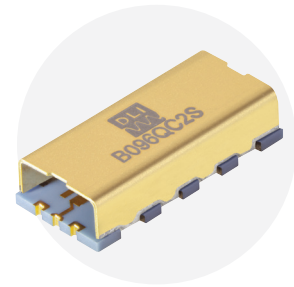
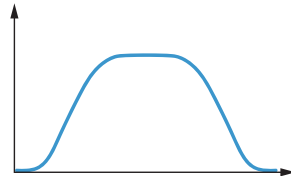

HIGHPASS

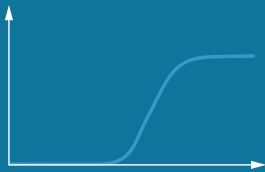

DLI's selection of lowpass and highpass filters aims to provide a drop-in solution for high-frequency attenuation. These filters have extreme repeatability, therefore multiple filters can be placed in series for increased rejection.

LOWPASS



DESIGN ADVANTAGES:

- Miniaturization enabled by specialty high-Q ceramics
- Fully shielded component
- Surface mount device configuration available
- Consistent performance
- 100% testing before ship



APPLICATIONS:



KEY CHARACTERISTICS:

- Low variation over a wide temperature range
- Integrated RF shielding
- Characteristic impedance: 50Ω
- Moisture sensitivity level: MSL1
- No ESD sensitivity

ADDITIONAL FILTER TYPES:

Cavity Filters Page 20	10
Notch Filters Page 21	45
Lumped Element Filters Custom	18
Helical Filters Custom	5
Coaxial Ceramic Filters Custom	10
Puck Ceramic Filters Custom	5

CERTIFICATION:



Filter Catalog

Part Number Structure

L	0	6	0	X	D	9	S
Filter type code	10 GHz Place Value	1 GHz Place Value	0.1 GHz Place Value	% BW Code	30 dB Rejection Level Code	Re-entrance Code	Package Code

FILTER TYPE CODE	
CODE	FILTER TYPE
B	BANDPASS
L	LOWPASS
H	HIGHPASS
C	CAVITY
N	NOTCH

PACKAGE CODE	
CODE	FILTER TYPE
W	WIRE-BOND
S	SMT

% BW CODE	
CODE	3DB% BW
J	0 - 1%
K	> 1 - 5%
L	> 5 - 10%
M	> 10 - 20%
N	> 30 - 40%
O	> 40 - 50%
P	> 50 - 60%
Q	> 50 - 60%
R	> 60%
X	LPF & HPF

30 DB REJECTION LEVEL CODE	
CODE	% OFF 3 DB CORNER
A	0 - 2%
B	> 2 - 4%
C	> 4 - 6%
D	> 6 - 8%
E	> 8 - 10%
F	> 10 - 15%
G	> 15 - 20%
H	> 20%

Notes:
 LPF & HPF: Percentage off of 3db corner
 BPF: Average percentage off 3dB BW
 Notch: Average percentage 3dB BW to 10dB BW

RE-ENTRANCE CODE	
CODE	RE-ENTRANT MULTIPLIED
0	1.2 - 1.4
1	> 1.4 - 1.6
2	> 1.6 - 1.8
3	> 1.8 - 2.0
4	> 2.0 - 2.2
5	> 2.2 - 2.4
6	> 2.4 - 2.6
7	> 2.6 - 3.8
8	> 2.8 - 3.0
9	> 3.0
X	HPF

Notes:
 Re-entrance is multiplier past the highside 30dB rejection level.
 Notch: Multiplier from corner of first notch to center or second notch

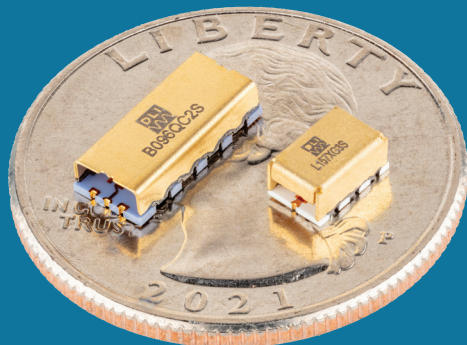

Bandpass Filter Ordering Information

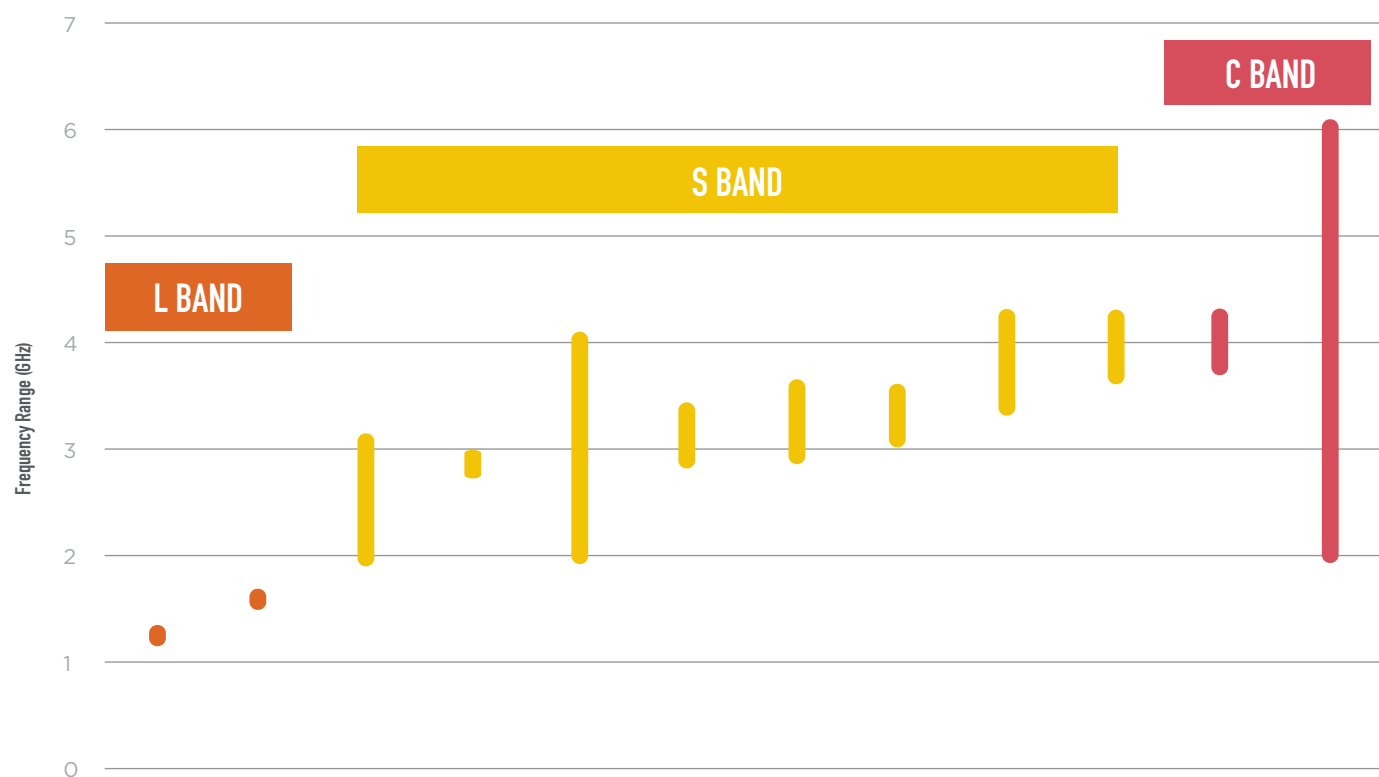

Part Number	B012MD5S	B016MD6S	B024RF2S	B028LB7S	B028RF2S	B031ND5S	B032ND5S	B033ND5S	B038NC4S	B039NC5S	B040MB5S	B040RG9S
Center Frequency (GHz)	1.227	1.575	2.4	2.8	2.8	3.1	3.24	3.3	3.8	3.95	4	4
Bandwidth (GHz)	0.01	0.01	1.08	0.2	2	0.43	0.6	0.4	0.8	0.5	0.44	4
Insertion Loss												
@ 25°C (dB)	3.5	3.5	3	2.5	2	3	3	2	2.25	2.5	2.5	2.75
-40°C to +85°C (dB)	4.2	4.2	3.5	3	3	3.5	3.5	3.2	2.5	2.75	2.75	3.25
VSWR	2.0:1	2.0:1	2.0:1	1.43:1	1.63:1	2.0:1	1.67:1	2.0:1	2.0:1	2.0:1	2.0:7	2.0:1
Rejection												
Amplitude (dB)	40	40	40	35	40	40	40	40	40	40	40	40
LS Range (GHz)	DC - 0.925	DC - 1.175	DC - 1.25	2.4 - 2.54	DC - 1.25	DC - 2.4	DC - 2.3	DC - 2.25	DC - 2.8	DC - 3.0	DC - 3.4	DC - 0.75
HS Range (GHz)	1.45 - 2.5	1.875 - 3.0	3.8 - 4.75	3.06 - 3.20	4.85 - 6.0	3.85 - 7.0	4.1 - 7.0	4.0 - 6.0	4.7 - 8.9	4.8 - 8.0	4.6 - 10.0	7.25 - 18.75
Dimensions (inches)												
Length	0.460	0.460	0.500	1.200	0.450	0.500	0.500	0.393	0.550	0.500	0.500	0.590
Width	0.460	0.460	0.250	0.350	0.400	0.250	0.250	0.353	0.220	0.250	0.250	0.280
Height	0.113	0.113	0.110	0.160	0.113	0.100	0.110	0.128	0.098	0.110	0.100	0.093
Dimensions (mm)												
Length	11.68	11.68	12.70	30.48	11.43	12.70	12.70	9.98	13.97	12.70	12.70	14.99
Width	11.68	11.68	6.35	8.89	10.16	6.35	6.35	8.97	5.59	6.35	6.35	7.11
Height	2.87	2.87	2.79	4.06	2.87	2.54	2.79	3.25	2.49	2.79	2.54	2.36



Bandpass Filter Ordering Information

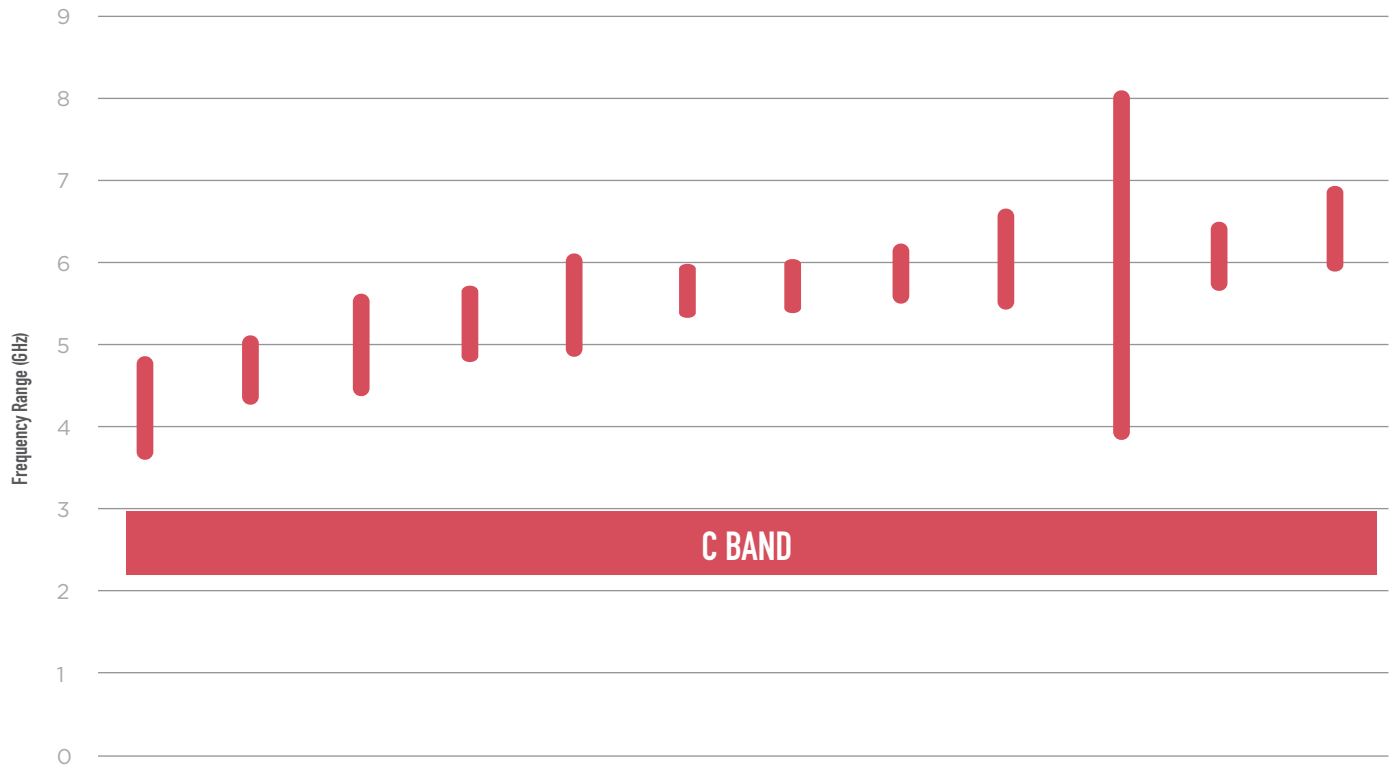

Part Number B0420D4S B047MC5S B050ND4S B052NC5S B055NC5S B056MB5S B057MC5S B058MD7S B060NC5S B056RC4S B061MB6S B062MC5S

Center Frequency (GHz)	4.2	4.7	5	5.2	5.5	5.6	5.7	5.8	6	5.6	6.1	6.3
Bandwidth (GHz)	1	0.6	1	0.8	1	0.05	0.5	0.6	1	4	0.5	0.8
Insertion Loss												
@ 25°C (dB)	3	2	2	2.25	2	2	2	2.3	2	3	3	2.5
-40°C to +85°C (dB)	3.5	2.5	2.5	2.75	2.5	2.5	2.5	2.8	3	3.5	3.5	2.75
VSWR	1.67:1	2.0:1	1.58:1	1.67:1	2.0:1.2	2.0:1.3	1.67:1	1.67:1	1.29:1	1.5:1	2.0:1	1.67:1
Rejection												
Amplitude (dB)	40	40	40	40	40	40	40	40	40	40	40	40
LS Range (GHz)	DC - 3.0	DC - 3.8	DC - 3.65	DC - 3.5	DC - 4.2	DC - 4.8	DC - 4.7	DC - 4.65	DC - 4.9	DC - 3.0	DC - 5.25	DC - 5.2
HS Range (GHz)	5.6 - 10.0	5.5 - 11.0	6.15 - 12.0	6.2 - 12.5	6.75 - 12.0	6.75 - 14.0	6.6 - 14.25	7.0 - 16.0	7.1 - 14.0	9.5 - 12.0	7.25 - 16.0	7.5 - 15.0
Dimensions (inches)												
Length	0.500	0.500	0.350	0.350	0.350	0.440	0.350	0.048	0.500	0.450	0.450	0.500
Width	0.250	0.250	0.200	0.200	0.200	0.240	0.200	0.275	0.200	0.230	0.200	0.250
Height	0.110	0.100	0.098	0.095	0.095	0.098	0.110	0.103	0.088	0.100	0.098	0.095
Dimensions (mm)												
Length	12.70	12.70	8.89	8.89	8.89	11.18	8.89	1.21	12.70	11.43	11.43	12.70
Width	6.35	6.35	5.08	5.08	5.08	6.10	5.08	6.99	5.08	5.84	5.08	6.35
Height	2.79	2.54	2.49	2.41	2.41	2.49	2.79	2.62	2.24	2.54	2.49	2.41

Bandpass Filter Ordering Information

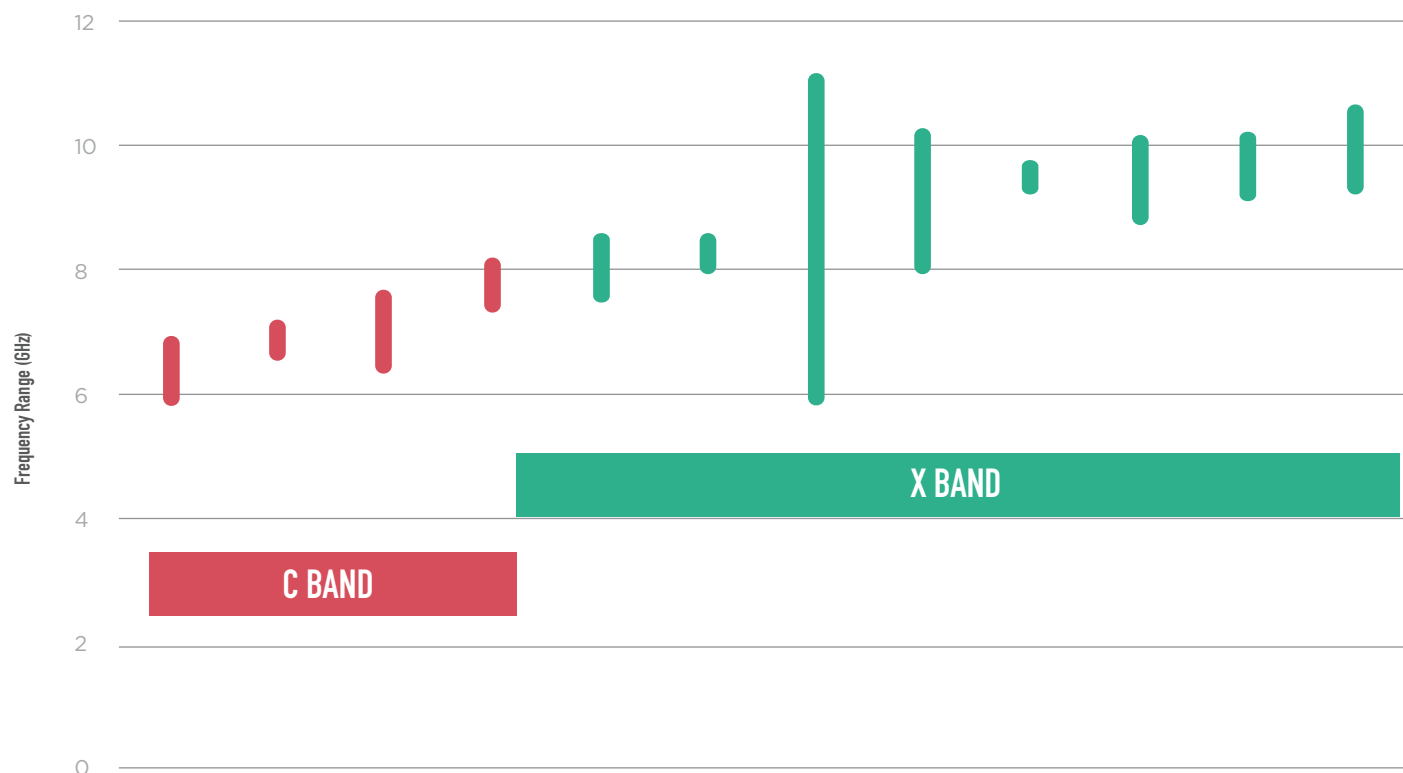

Part Number	B065NC5S	B070MB6S	B070NC5S	B076MB6S	B080MB5S	B083LB6S	B081RC0S	B089NC4S	B094LA2S	B095MB1S	B097MB0S	B100MC5S
Center Frequency (GHz)	6.5	7.1	7	7.6	8	8.3	8.1	8.9	9.4	9.5	9.7	10
Bandwidth (GHz)	1	0.55	1.26	0.72	1	0.5	5	2	0.35	1.1	0.8	1
Insertion Loss												
@ 25°C (dB)	3	2.5	2	2.5	2	2.5	3.4	2.5	2.75	1.75	2.5	2
-40°C to +85°C (dB)	3.5	2.75	2.5	2.75	3	2.75	3.9	2.75	3	2	2.75	2.5
VSWR	1.67:1	2.0:1	2.0:1	2.2:1	1.29:1	1.92:1	2.0:1	1.92:1	1.58:1	1.92:1	1.92:1	1.92:1
Rejection												
Amplitude (dB)	40	40	40	40	40	40	40	40	40	40	40	40
LS Range (GHz)	DC - 5.2	DC - 6.2	DC - 5.8	DC - 6.69	DC - 6.8	DC - 8.825	DC - 3.5	DC - 6.8	DC - 8.6	DC - 8.0	DC - 8.1	DC - 8.5
HS Range (GHz)	7.75 - 15.0	7.8 - 15.0	8.5 - 17.5	8.52 - 18.25	9.25 - 17.0	11.35 - 16.5	14.0 - 19.0	11.25 - 20.0	10.25 - 15.0	11.5 - 20.0	11.35 - 23.0	11.75 - 20.0
Dimensions (inches)												
Length	0.500	0.500	0.500	0.500	0.500	0.450	0.190	0.400	0.450	0.400	0.400	0.400
Width	0.250	0.200	0.200	0.200	0.180	0.200	0.100	0.150	0.200	0.150	0.150	0.150
Height	0.095	0.100	0.100	0.100	0.100	0.103	0.090	0.103	0.098	0.103	0.103	0.098
Dimensions (mm)												
Length	12.70	12.70	12.70	12.70	12.70	11.43	4.83	10.16	11.43	10.16	10.16	10.16
Width	6.35	5.08	5.08	5.08	4.57	5.08	2.54	3.81	5.08	3.81	3.81	3.81
Height	2.41	2.54	2.54	2.54	2.54	2.62	2.29	2.62	2.49	2.62	2.62	2.49



Bandpass Filter Ordering Information

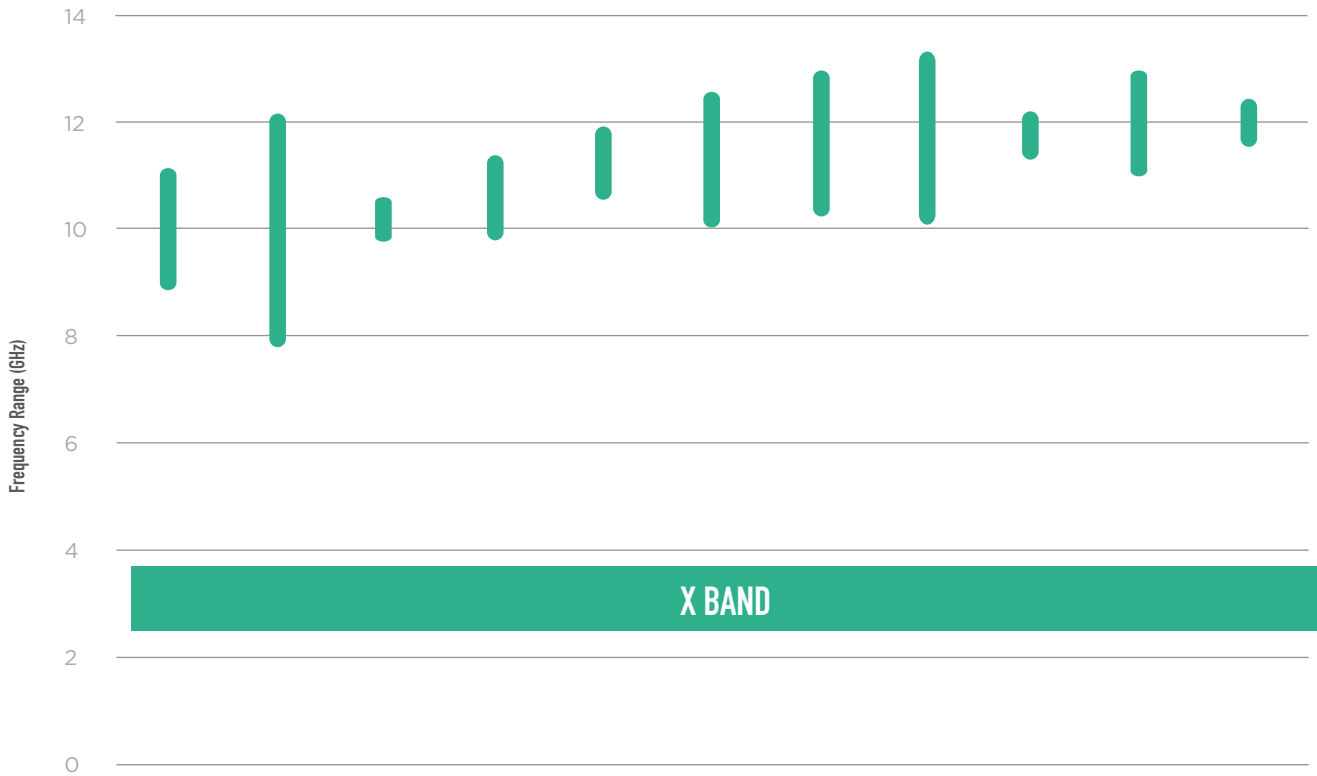

Part Number	B099NC4S	B096QC2S	B102MC1S	B105MB5S	B112MB1S	B111NC4S	B115NB4S	B116NC5S	B118LB4S	B119MB1S	B119LB1S
Center Frequency (GHz)	10.25	10	10.25	10.6	11.2	11.2	11.6	11.4	11.8	11.9	11.9
Bandwidth (GHz)	2.25	4	0.5	1.2	1	2.5	2.5	2.25	0.5	2.7	2.2
Insertion Loss											
@ 25°C (dB)	2.25	2.5	2.25	1.75	2.25	2.25	2.5	2.25	2.5	3	3.25
-40°C to +85°C (dB)	2.25	3	2.25	2	2.75	2.25	2.75	2.5	2.75	3.75	3.75
VSWR	1.58:1	2.0:1	1.92:1	1.92:1	1.92:1	1.92:1	1.92:1	1.92:1	1.58:1	1.92:1	2.0:1
Rejection											
Amplitude (dB)	40	40	40	40	40	40	40	40	40	40	40
LS Range (GHz)	DC - 8.5	DC - 6.0	DC - 9.0	DC - 8.0	DC - 9.4	DC - 8.75	DC - 9.5	DC - 9.0	DC - 10.25	DC - 9.8	DC - 10.75
HS Range (GHz)	11.75 - 20.0	14.0 - 18.0	11.35 - 16.5	13.0 - 23.5	13.25 - 20.0	14.5 - 25.0	14.5 - 23.0	14.25 - 23.5	13.25 - 18.0	13.9 - 20.0	13 - 19.5
Dimensions (inches)											
Length	0.400	0.400	0.450	0.450	0.400	0.400	0.575	0.400	0.450	0.450	0.450
Width	0.150	0.180	0.200	0.200	0.150	0.150	0.200	0.150	0.200	0.200	0.200
Height	0.098	0.100	0.090	0.103	0.103	0.090	0.093	0.090	0.103	0.098	0.098
Dimensions (mm)											
Length	10.16	10.16	11.43	11.43	10.16	10.16	14.61	10.16	11.43	11.43	11.43
Width	3.81	4.57	5.08	5.08	3.81	3.81	5.08	3.81	5.08	5.08	5.08
Height	2.29	2.54	2.29	2.62	2.62	2.29	2.36	2.29	2.62	2.49	2.49

Bandpass Filter Ordering Information

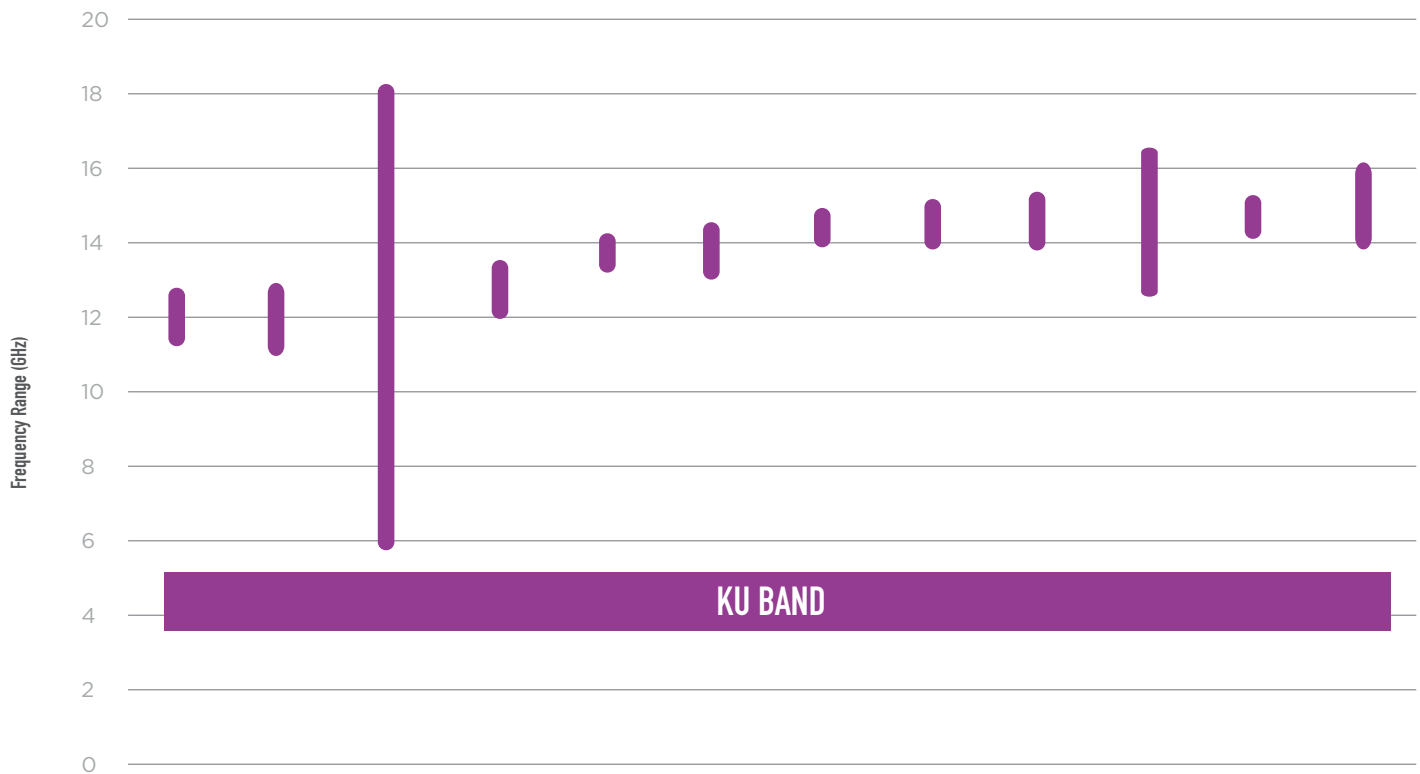

Part Number	B120MB1S	B121MB4S	B120RF0S	B127MB2S	B138LA2S	B138MB1S	B142LA2S	B145LB1S	B144MB1S	B1500G0S	B148LA2S	B149MC1S
Center Frequency (GHz)	12	12	12	12.75	13.75	13.75	14.2	14.5	14.5	14.5	14.75	15
Bandwidth (GHz)	1	1.5	12	1	0.5	1	0.5	0.8	1	3	0.5	2
Insertion Loss												
@ 25°C (dB)	2	2.5	2.5	2.75	2.75	2.75	4.5	3.5	2.4	2.25	3.25	2.25
-40°C to +85°C (dB)	3	3	3	3	3.25	3	5	3.75	2.5	2.5	3.5	2.5
VSWR	1.29:1	1.92:1	2.0:1	1.58:1	1.58:1	1.58:1	2.0:1	2.0:1	1.58:1	1.58:1	1.58:1	1.58:1
Rejection												
Amplitude (dB)	40	40	40	40	40	40	40	40	40	40	40	40
LS Range (GHz)	DC - 10.6	DC - 9.5	DC - 3.3	DC - 10.75	DC - 12.5	DC - 11.75	DC - 13.25	DC - 12.5	DC - 12.25	DC - 10.5	DC - 13.25	DC - 11.0
HS Range (GHz)	13.2 - 19.5	14.5 - 24.25	19.8 - 22.0	14.25 - 19.75	14.75 - 22.00	15.25 - 21.00	15.25 - 25.0	16 - 22.25	16.25 - 22.0	18.0 - 25.0	16.0 - 20.0	18.5 - 23.0
Dimensions (inches)												
Length	0.525	0.400	0.450	0.400	0.450	0.400	0.575	0.550	0.400	0.375	0.450	0.350
Width	0.225	0.150	0.200	0.200	0.180	0.200	0.200	0.230	0.200	0.140	0.180	0.200
Height	0.090	0.103	0.103	0.098	0.098	0.098	0.093	0.093	0.098	0.093	0.098	0.098
Dimensions (mm)												
Length	13.34	10.16	11.43	10.16	11.43	10.16	14.61	13.97	10.16	9.53	11.43	8.89
Width	5.72	3.81	5.08	5.08	4.57	5.08	5.08	5.84	5.08	3.56	4.57	5.08
Height	2.29	2.62	2.62	2.49	2.49	2.49	2.36	2.36	2.49	2.36	2.49	2.49



Bandpass Filter Ordering Information

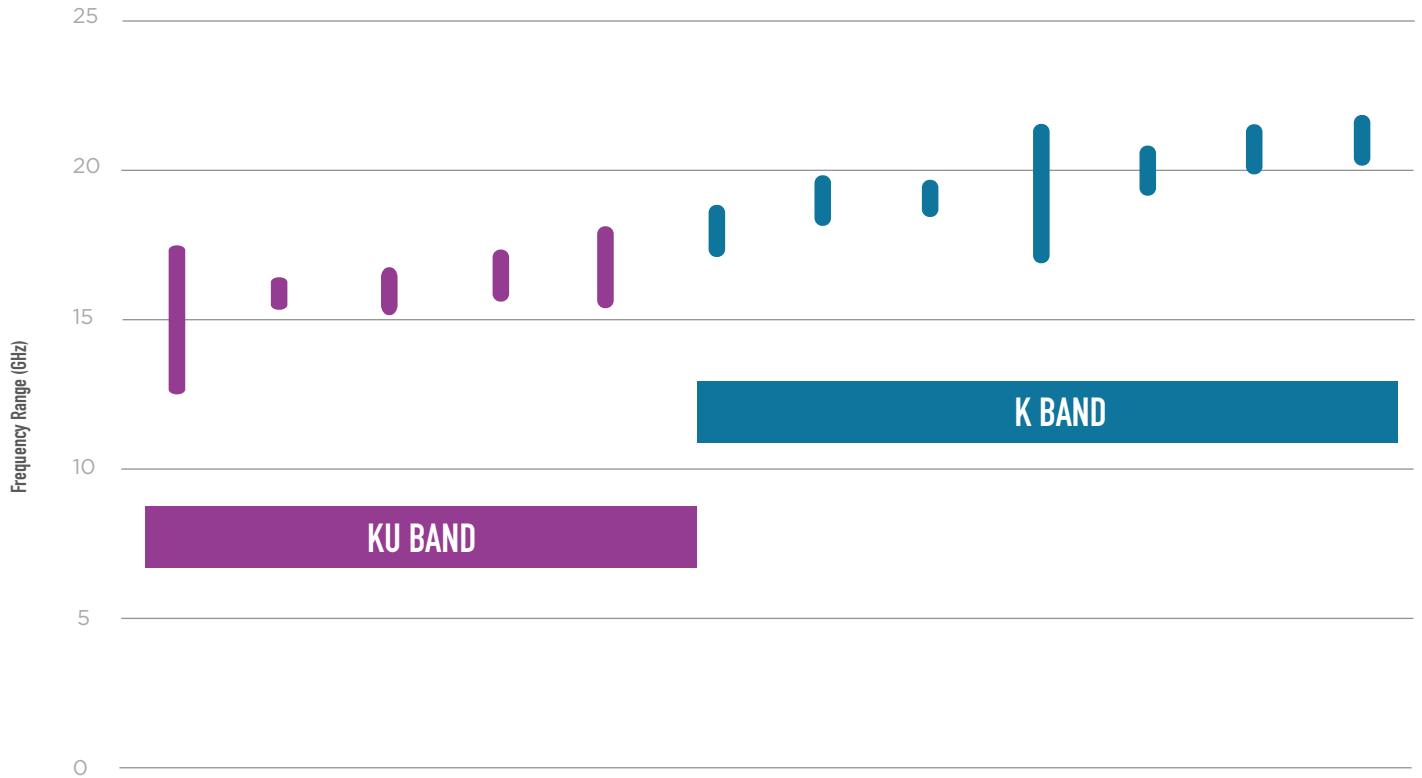

Part Number	B148QF0S	B160KA1S	B161LA0S	B165LA1S	B168MB1S	B180MA1S	B190MB1S	B191KA1S	B192NB2S	B200LA0S	B207LA0S	B210LA0S
Center Frequency (GHz)	15	16	16	16.5	16.75	18	19	19.1	19.2	20	20.7	21
Bandwidth (GHz)	6	0.5	1	1	2	1	1	0.5	4	1	1	1
Insertion Loss												
@ 25°C (dB)	3.6	2.75	4	2.75	2.5	3	3	4.5	3.75	3	3.75	3.25
-40°C to +85°C (dB)	4.2	3	6	3	2.75	3.25	3.25	5	4.25	3.5	4.25	3.75
VSWR	1.63:1	1.58:1	1.67:1	1.58:1	1.58:1	2.0:1	2.0:1	2.0:1	1.92:1	1.92:1	2.0:1	2.0:1
Rejection												
Amplitude (dB)	40	40	40	40	40	40	40	40	40	40	40	40
LS Range (GHz)	DC - 7.6	DC - 14.25	DC - 14.7 5	DC - 14.5	DC - 13.4	DC - 16.25	DC - 17.0	DC - 18.0	DC - 15.0	DC - 18.25	DC - 18.7	DC - 19.25
HS Range (GHz)	23.0 - 25.0	17.75 - 20.5	17.3 - 22.00	18.0 - 25.0	19.25 - 24.00	19.5 - 27.5	20.75 - 27.0	20.0 - 26.0	23.25 - 35.0	21.35 - 28.0	22.4 - 27.0	22.75 - 26.75
Dimensions (inches)												
Length	0.550	0.400	0.695	0.400	0.350	0.450	0.450	0.575	0.450	0.450	0.450	0.450
Width	0.150	0.200	0.250	0.200	0.200	0.175	0.175	0.200	0.140	0.175	0.175	0.175
Height	0.098	0.098	0.093	0.098	0.098	0.093	0.093	0.093	0.088	0.093	0.093	0.093
Dimensions (mm)												
Length	13.97	10.16	17.65	10.16	8.89	11.43	11.43	14.61	11.43	11.43	11.43	11.43
Width	3.81	5.08	6.35	5.08	5.08	4.45	4.45	5.08	3.56	4.45	4.45	4.45
Height	2.49	2.49	2.36	2.49	2.49	2.36	2.36	2.36	2.24	2.36	2.36	2.36



Bandpass Filter Ordering Information

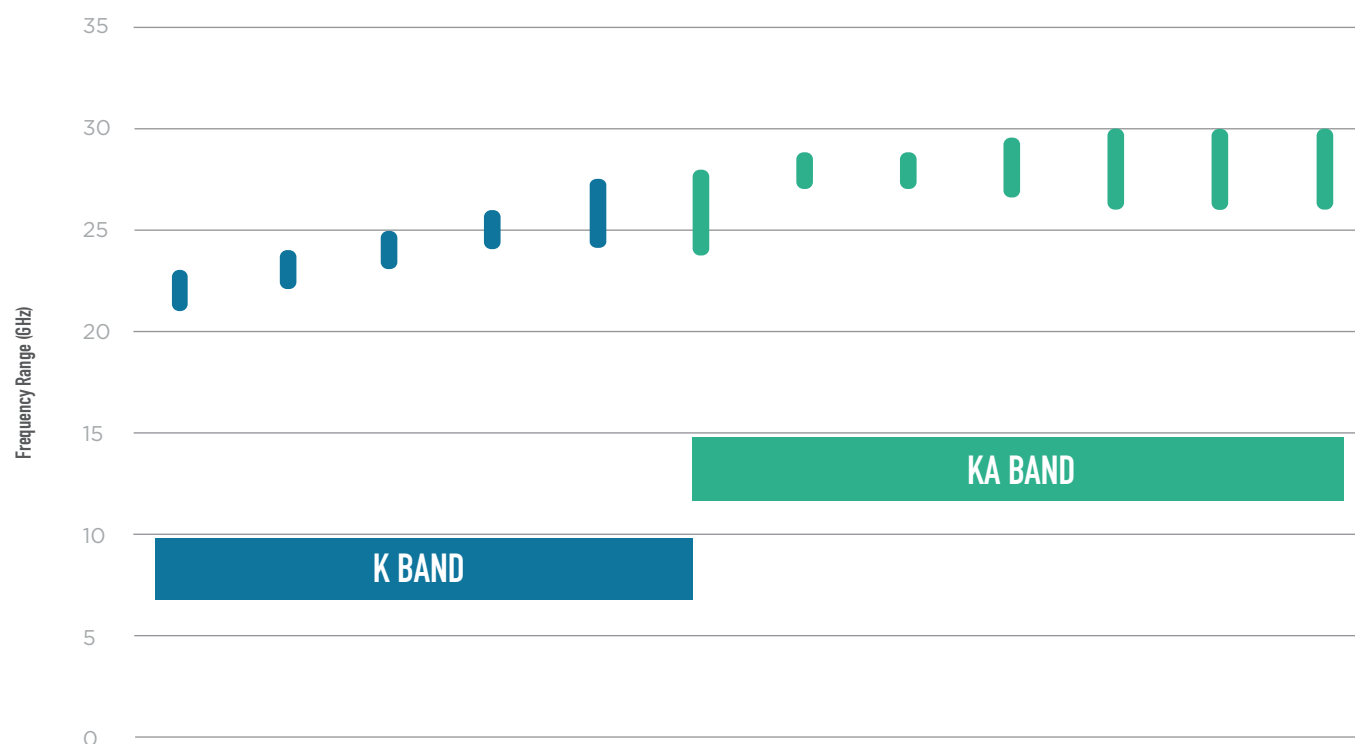

Part Number	B220LA0S	B230LA0S	B240LA0S	B250LA0S	B260MB2S	B259MC1S	B279KB1S	B280LA0S	B280LB0S	B274MB1S	B280MC1S	B280MD1S
Center Frequency (GHz)	22	23	24	25	26	26	27.9	28	28	28	28	28
Bandwidth (GHz)	1	1	1	1	3	3.25	0.85	1	2	3	3	3
Insertion Loss												
@ 25°C (dB)	4	4	4	4	5	4	3.75	4.5	2	3.5	3.5	3
-40°C to +85°C (dB)	4.25	4.5	4.5	4.5	5.25	4.25	4.25	4.75	2.5	3.75	4	3.5
VSWR	2.0:1	2.0:1	2.0:1	2.0:1	1.58:1	1.58:1	1.58:1	1.92:1	1.58:1	1.58:1	1.58:1	1.58:1
Rejection												
Amplitude (dB)	40	40	40	40	40	30	40	30	40	40	30	35
LS Range (GHz)	DC - 20.25	DC - 21.25	DC - 22.0	DC - 23.0	DC - 22.6	DC - 23.0	DC - 25.9	DC - 26.0	DC - 25.0	DC - 24.0	DC - 24.5	DC - 23.5
HS Range (GHz)	23.75 - 28.6	25.0 - 31.5	25.7 - 30.0	26.75 - 30.0	28.6 - 35.0	29.5 - 41.0	30.0 - 40.0	30.0 - 38.0	30.75 - 34.25	31.0 - 39.0	31.0 - 41.0	31.75 - 42.0
Dimensions (inches)												
Length	0.450	0.450	0.450	0.450	0.260	0.217	0.290	0.550	0.350	0.450	0.217	0.158
Width	0.140	0.140	0.140	0.140	0.120	0.090	0.080	0.140	0.120	0.110	0.090	0.090
Height	0.088	0.088	0.088	0.088	0.079	0.070	0.070	0.083	0.098	0.089	0.070	0.070
Dimensions (mm)												
Length	11.43	11.43	11.43	11.43	6.60	5.50	7.37	13.97	8.89	11.43	5.50	4.01
Width	3.56	3.56	3.56	3.56	3.05	2.29	2.03	3.56	3.05	2.79	2.29	2.29
Height	2.24	2.24	2.24	2.24	2.01	1.78	1.78	2.11	2.49	2.26	1.78	1.78



Bandpass Filter Ordering Information

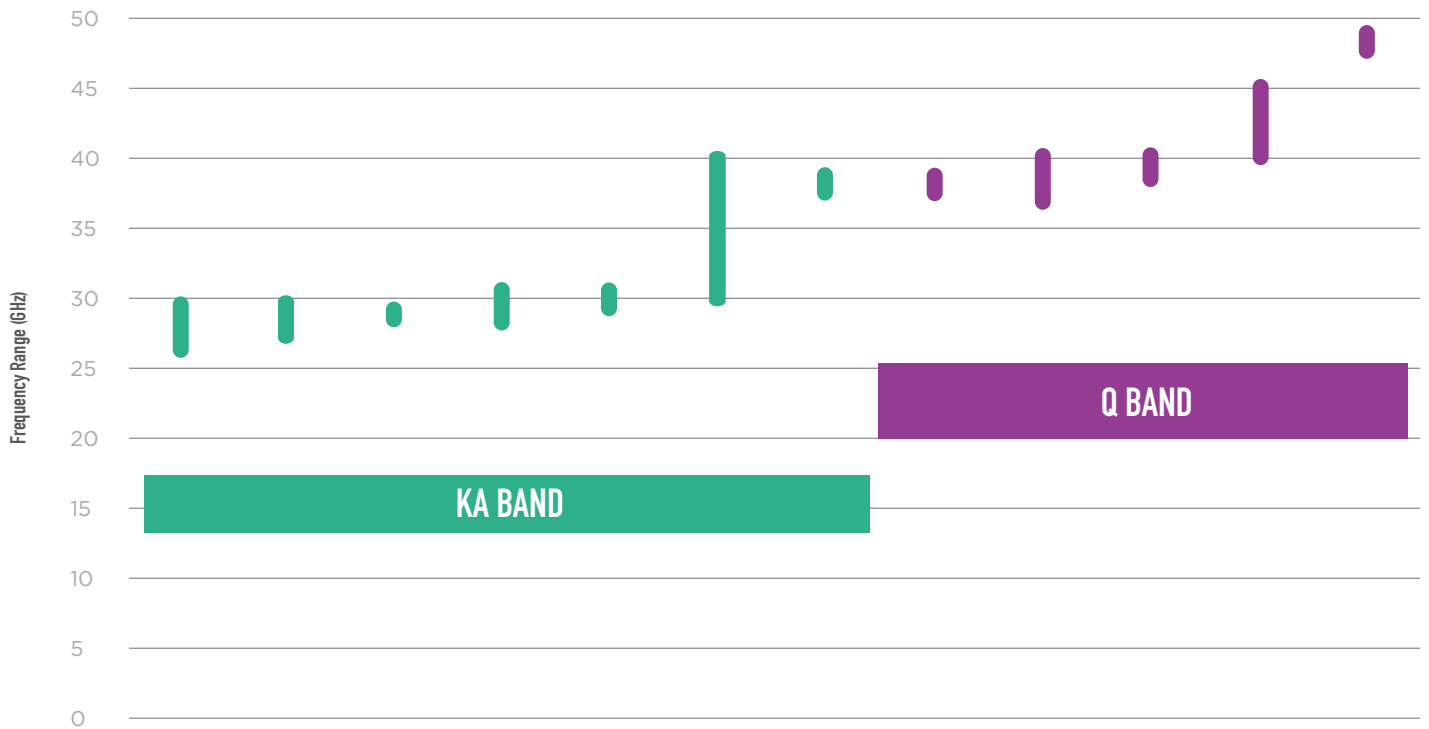

Part Number	B280MF1S	B285LB2S	B289KA0S	B291MB0S	B305LA0S	B350NB2S	B380KA1S	B381KD0S	B385MD0S	B393KD0S	B424MEZS	B479KB0S
Center Frequency (GHz)	28	28.5	28.9	29.25	30.5	35	38	38.1	38.5	39.3	42.5	47.9
Bandwidth (GHz)	3	2	0.5	3.5	1	10	1	1	3	1.4	4.75	1
Insertion Loss												
@ 25°C (dB)	3	3.25	4.3	3	4	4.25	4.5	2.5	2.5	2.5	3	4.25
-40°C to +85°C (dB)	3.25	3.75	4.8	3.5	4.5	4.75	5	2.75	2.75	2.75	3.5	4.75
VSWR	1.58:1	1.58:1	2.0:1	2.0:1	2.0:1	1.92:1	1.92:1	1.92:1	1.92:1	1.92:1	2.0:1	1.92:1
Rejection												
Amplitude (dB)	30	40	40	40	40	40	35	40	40	40	40	40
LS Range (GHz)	DC - 23.0	DC - 25.7	DC - 27.2	DC - 25.25	DC - 28.25	DC - 26.0	DC - 36.0	DC - 35	DC - 34.0	DC - 36	DC - 37.50	DC - 40.0
HS Range (GHz)	32.0 - 42.0	31.0 - 40.0	30.6 - 34.0	32.5 - 35.0	32.7 - 38.0	32.5 - 48.0	39.2 - 45.0	43 - 53	44.0 - 56.0	45 - 53	47.5 - 60.0	51.5 - 62.0
Dimensions (inches)												
Length	0.158	0.330	0.550	0.450	0.550	0.275	0.300	0.275	0.275	0.275	0.236	0.25
Width	0.090	0.120	0.140	0.140	0.140	0.080	0.080	0.080	0.080	0.080	0.080	0.08
Height	0.070	0.079	0.078	0.088	0.078	0.070	0.074	0.070	0.070	0.070	0.065	0.085
Dimensions (mm)												
Length	4.01	8.38	13.97	11.43	13.97	6.99	7.62	6.99	6.99	6.99	5.99	6.35
Width	2.29	3.05	3.56	3.56	3.56	2.03	2.03	2.03	2.03	2.03	2.03	2.03
Height	1.78	2.01	1.98	2.24	1.98	1.78	1.88	1.78	1.78	1.78	1.65	2.16

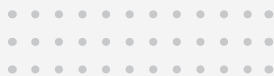

Lowpass Filter Selection

Part Number	L050XF9S	L065XG9S	L065XG9W	L095XG9S	L117XH4S	L117XH4W	L128XH4S	L157XG3S
Passband Frequency (GHz)								
3dB Cutoff Frequency	5	6.5	6.5	9.5	11.7	11.7	12.8	15.7
Low	DC	DC	DC	DC	DC	DC	DC	DC
High	4	6	6	9	11	11	12	15
Insertion Loss								
Max @25°C (dB)	1.0	1.3	1.3	1.3	1.0	2.0	1.2	2.2
Dimensions (inches)								
Length	0.220	0.220	0.220	0.220	0.220	0.220	0.220	0.220
Width	0.180	0.180	0.140	0.140	0.140	0.140	0.140	0.140
Height	0.103	0.103	0.118	0.103	0.103	0.113	0.103	0.103
Dimensions (mm)								
Length	5.59	5.59	5.59	5.59	5.59	5.59	5.59	5.59
Width	4.57	4.57	3.56	3.56	3.56	3.56	3.56	3.56
Height	2.62	2.62	3.00	2.62	2.62	2.87	2.62	2.62

Part Number	L157XF3W	L185XF4S	L185XF4W	L204XF4S	L220XH5S	L254XF3S	L288XC3S
Passband Frequency (GHz)							
3dB Cutoff Frequency	17	18.5	18.5	20.4	22	25.4	28.6
Low	DC	DC	DC	DC	DC	DC	DC
High	16.5	18	18	20	22.4	25	27.65
Insertion Loss							
Max @25°C (dB)	2.0	2.2	2.0	1.8	2.5	1.4	2.0
Dimensions (inches)							
Length	0.220	0.220	0.220	0.220	0.220	0.220	0.220
Width	0.140	0.140	0.140	0.140	0.140	0.140	0.140
Height	0.108	0.098	0.113	0.098	0.118	0.098	0.098
Dimensions (mm)							
Length	5.59	5.59	5.59	5.59	5.59	5.59	5.59
Width	3.56	3.56	3.56	3.56	3.56	3.56	3.56
Height	2.74	2.49	2.87	2.49	3.00	2.49	2.49

Highpass Filter Selection

Part Number	H060XHXS	H080XHXS	H100XHXS	H120XHXS	H140XHXS	H160XHXS	H168XHXS	H182XHXS
Passband Frequency (GHz)								
3dB Cutoff Frequency	6	8	10	12	14	16	16.95	18.2
Low	6.5	8.5	10.5	12.5	14.5	16.5	18	18.75
High	20	22	23	30	28	32.5	30	28
Insertion Loss								
Max @25°C (dB)	1	1	1	1	1	1	1	1
Dimensions (inches)								
Length	0.450	0.450	0.450	0.450	0.450	0.450	0.450	0.450
Width	0.200	0.200	0.175	0.175	0.175	0.175	0.175	0.175
Height	0.093	0.093	0.083	0.083	0.083	0.083	0.083	0.083
Dimensions (mm)								
Length	11.43	11.43	11.43	11.43	11.43	11.43	11.43	11.43
Width	5.08	5.08	4.45	4.45	4.45	4.45	4.45	4.45
Height	2.36	2.36	2.11	2.11	2.11	2.11	2.11	2.11



How To Specify a Filter

Type — Bandpass (BP), Notch (N),
Lowpass (LP), Highpass (HP) _____

Center Frequency, F_c (GHz) $F_c =$ _____ GHz

3dB Bandwidth (MHz) $BW_{3dB} =$ _____ GHz

Insertion Loss (IL) @ F_c (dB) $IL =$ _____ (dB)

Passband Return Loss (RL) @ F_c :
dB Reference — 50 Ohms $RL =$ _____ (dB)

Upper Frequency Rejection - _____ dB @ _____ GHz

Lower Frequency Rejection - _____ dB @ _____ GHz

Power Handling (Watts) Power (average) = _____ Watts,
Power (peak) = _____ Watts
Duty Cycle _____ %

Operating Temperature Range $T_{min} =$ _____ °C, $T_{max} =$ _____ °C

Mounting Technique: Circle one Surface Mount (S) or Chip and Wire

Size (limits) Length _____, Width _____,
Thickness _____
Circle one inches or mm

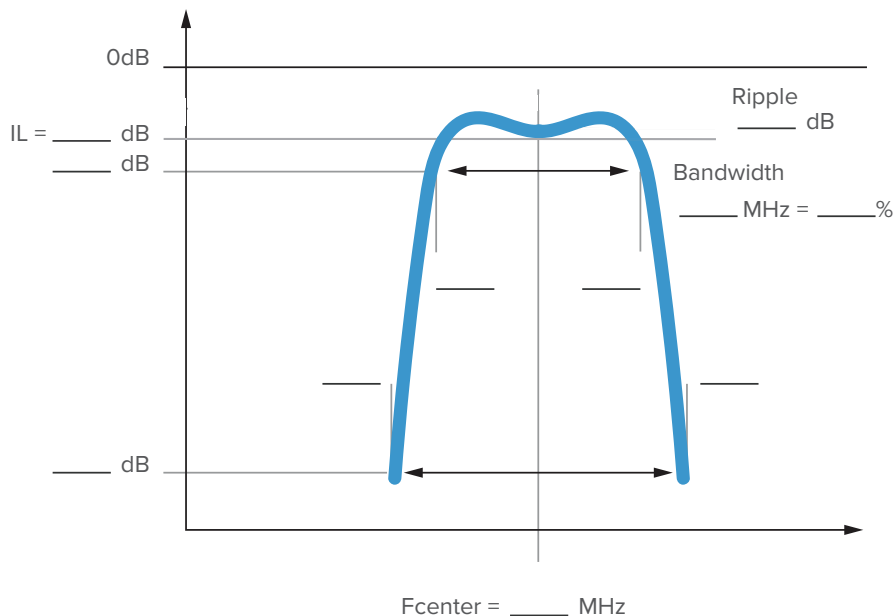

Cavity Filters

DLI brand cavity filters utilize proprietary high-Q ceramics to enable miniaturized, highly selective low-loss SMD filters. This design dramatically reduces the part's size, compared to traditional air-filled cavity filters, which makes them a perfect choice for applications with SWAP constraints. These cavity filters enable integration with their small size, shielding and surface mount configuration, achieving repeatable performance without the need for mechanical tuning.



DESIGN ADVANTAGES:

- High quality factor
- 5x Smaller than typical air filled cavities
- True SMD with integrated shielding
- Excellent repeatability without mechanical tuning
- 100% tested and inspected
- Custom designs available
- Narrow bandwidths featured



APPLICATIONS:

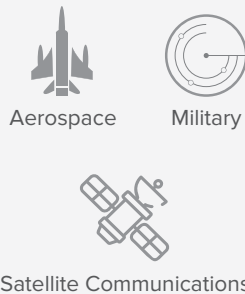

KEY CHARACTERISTICS:

- Low loss in passband: 1-3dB typical
- Devices scalable from C to Ku band
- Bandwidth 0.5-3%

Part Number	C079KB1S	C142KB0S
Center Frequency (GHz)	7.85	14.25
Bandwidth (GHz)	0.15	0.5
Insertion Loss		
@ 25°C (dB)	2.25	2.25
-40°C to +85°C (dB)	2.75	2.75
Return Loss		
@ 25°C (dB)	14	14
Rejection		
Amplitude (dB)	50	50
LS Range (GHz)	DC - 7.25	DC - 12.9
HS Range (GHz)	8.5 - 11.0	16.6 - 19
Dimensions (inches)		
Length	0.937	0.636
Width	0.0238	0.238
Height	0.064	0.064
Dimensions (mm)		
Length	23.80	16.15
Width	0.60	6.05
Height	1.63	1.63

TYPICAL CAVITY FILTER TRANSMISSION COEFFICIENT

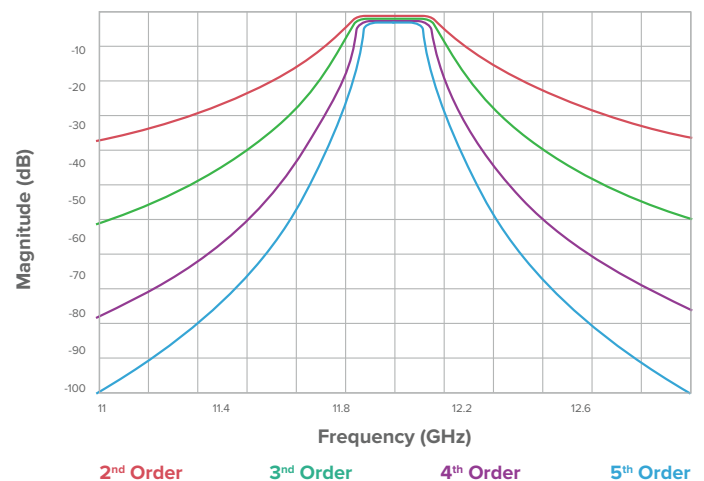

Ceramic Cavity Resonators

DLI brand's ceramic cavity resonators leverage our high-Q, temperature-stable dielectric materials and precision photolithography to realize new capabilities for oscillator applications. One or two port resonator configurations allow the resonator designer a unique opportunity to tightly control all of the important resonator characteristics, such as resonance frequency, Q and coupling coefficient. This makes our cavity resonators an ideal solution for implementation in high-performance, low-cost microwave or mmWave oscillators.

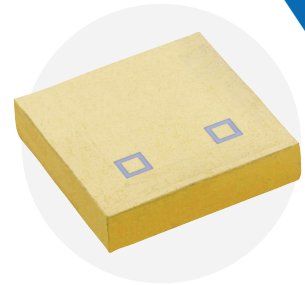

Frequencies of resonator designs range from 1.0 to 67 GHz and can be customized for either solder-surface mount or chip and wire implementation. Contact DLEngineering@Knowles.com to discuss your resonator needs.



DESIGN ADVANTAGES:

- Miniature size: .020 x .034 (.5mm x .86mm)
- Simplifies assembly with 1 component



APPLICATIONS:

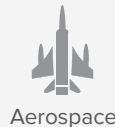

KEY CHARACTERISTICS:

- Eliminate large, expensive housings
- Measured using RF coplanar probes – no fixtures necessary
- Unloaded Q factor of up to 2000

Notch Filters

DLI brand notch filters offer attenuation of signals in a specific band, with a compact footprint and extreme repeatability. These are often used in conjunction with a bandpass filter to further attenuate certain frequencies. Contact us for a custom solution for the frequency range you need.

PART NUMBERS

Part Number	N012ME9S	N016MD9S
Notch Frequency (MHz)	1227	1575
Passbands (MHz)	500-1000 and 1500-2000	DC-1300 and 1800-3000
Passband Insertion Loss (dB)	1.5	1.5
Rejection for 1222-1233 MHz (dB)	20	20
Length (in)	0.350	0.250
Width (in)	0.300	0.250
Height (in)	0.103	0.100

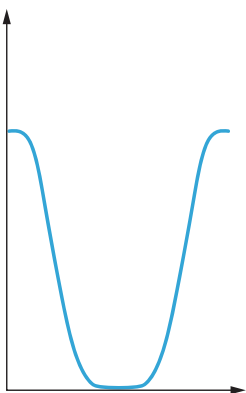

CERTIFICATION:



Custom is Standard for Us

What you see in this catalog is just the tip of the iceberg for the design capability with Knowles!

Collaboration Is the Key to Top Performance!

- Leverage Knowles expertise to achieve your performance goals with low cost of ownership and optimized SWAP-C
- Utilize DLI brand ceramics to achieve stable performance over wide temperature ranges
- Achieve the best manufacturing outcomes with Knowles' precision processing and testing capabilities

DLI Design

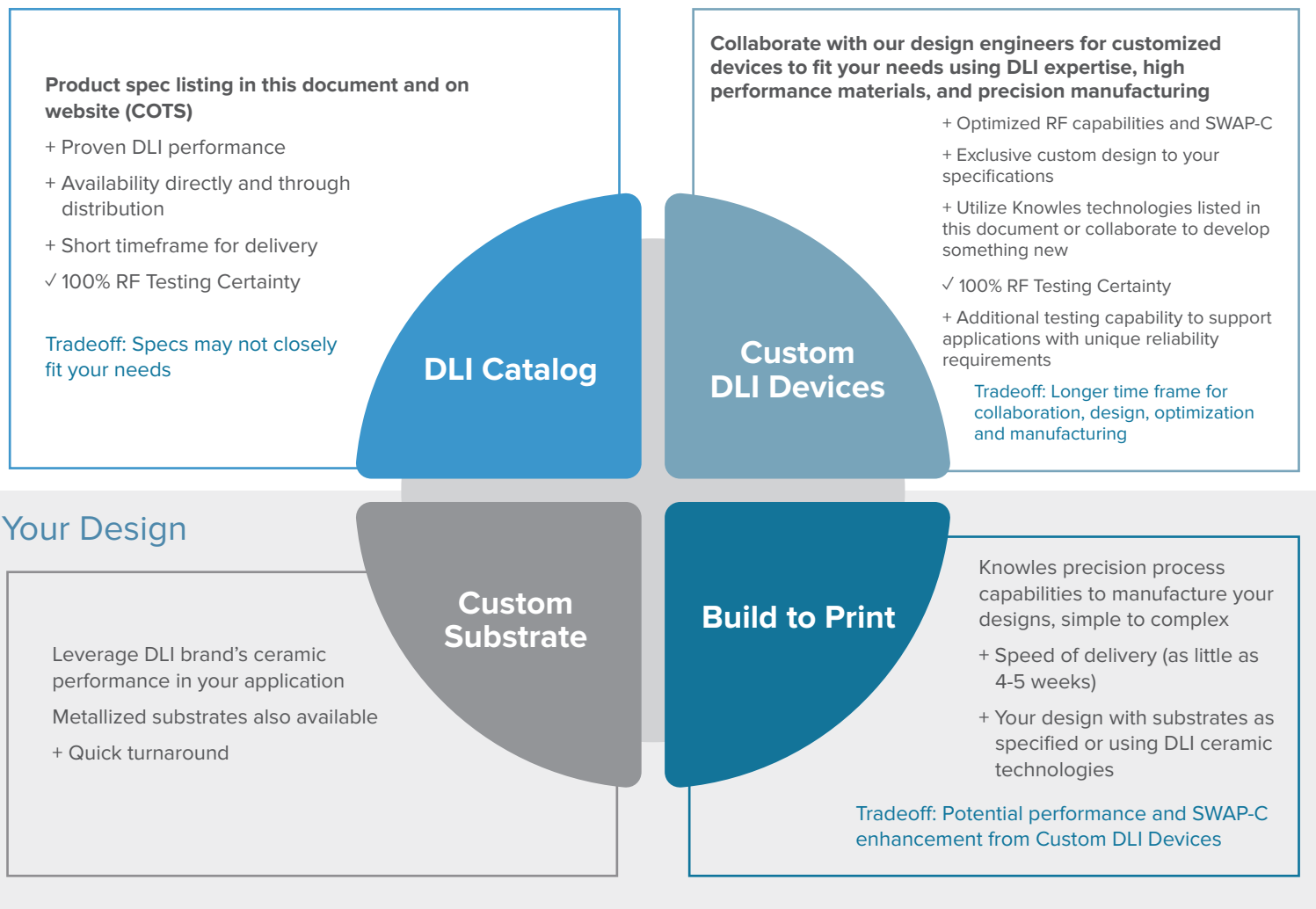

Reach out to discuss your application with our engineering team: DLIengineering@Knowles.com



Custom Devices

Knowles offers a wide range of technologies to meet your application needs.

FILTERS	<ul style="list-style-type: none"> • Microstrip Filters • Cavity Filters • Ceramic Filters* • Lumped Element Filters* 	0.1 MHz - 67+ GHz
COUPLERS	<ul style="list-style-type: none"> • Wilkinson Couplers • Resistive Couplers • Quadrature Hybrid Couplers* 	0.3 - 60 GHz
DIVIDERS	<ul style="list-style-type: none"> • Wilkinson Power Dividers (or Combiners) • Resistive Power Dividers 	2 - 60 GHz
MULTIPLEXERS	<ul style="list-style-type: none"> • Diplexers • Duplexers 	0.1 MHz - 67 GHz
RESONATORS	<ul style="list-style-type: none"> • Ceramic resonators* • Thin film resonators 	0.3 - 65 GHz
INTERGRATED PASSIVES	<ul style="list-style-type: none"> • CRC Networks • Custom Solutions 	DC - 67+ GHz

*Expanded Offerings

SUPPORTED TECHNOLOGIES & APPLICATIONS:

- Heat sinks standoffs
- Custom resistor/capacitor networks
- Lange couplers
- Power combiners
- EMI filters
- High-frequency filters
- Microwave-integrated circuits (MIC)
- Bias decoupling
- Bias filtering
- Lumped element impedance matching network
- PA stabilization
- Impedance matching and power combining network



Build to Print Services and Substrates

Knowles manufactures a wide range of customer designed devices.



BUILD-TO-PRINT BASICS EBOOK

A COMPREHENSIVE GUIDE TO
KNOWLES PRECISION DEVICES'
BUILD-TO-PRINT SERVICES AND
THIN-FILM TECHNOLOGY

2777 Hwy 20
Cazenovia, NY 13035

(315) 655-8710

info@knowles.com
knowlescapacitors.com

Check out Knowles' Build-to-Print e-Book online!

Featuring:

- Substrate Selection
- Metallization
- Laser Techniques
- Conductors
- Vias
- Resistors
- Reliable Connections
- Bias Networks
- Testing
- Military and Space Grade Applications
- From Prototype to High Volume Production



Visit info.knowlescapacitors.com/build-to-print-basics to download the e-Book and view the full menu of product offerings

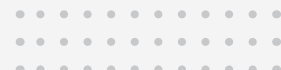

Integrating RF Passives on a Single Substrate

Knowles Precision Devices has done a lot of passive integration!

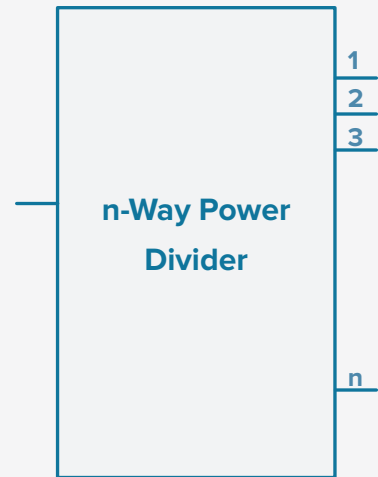
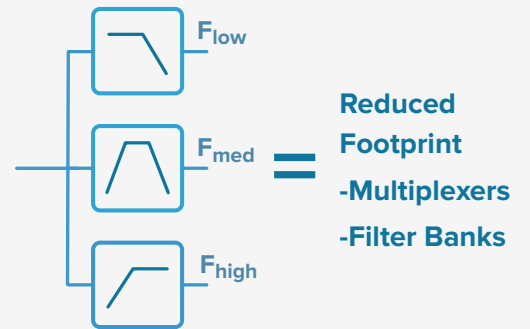
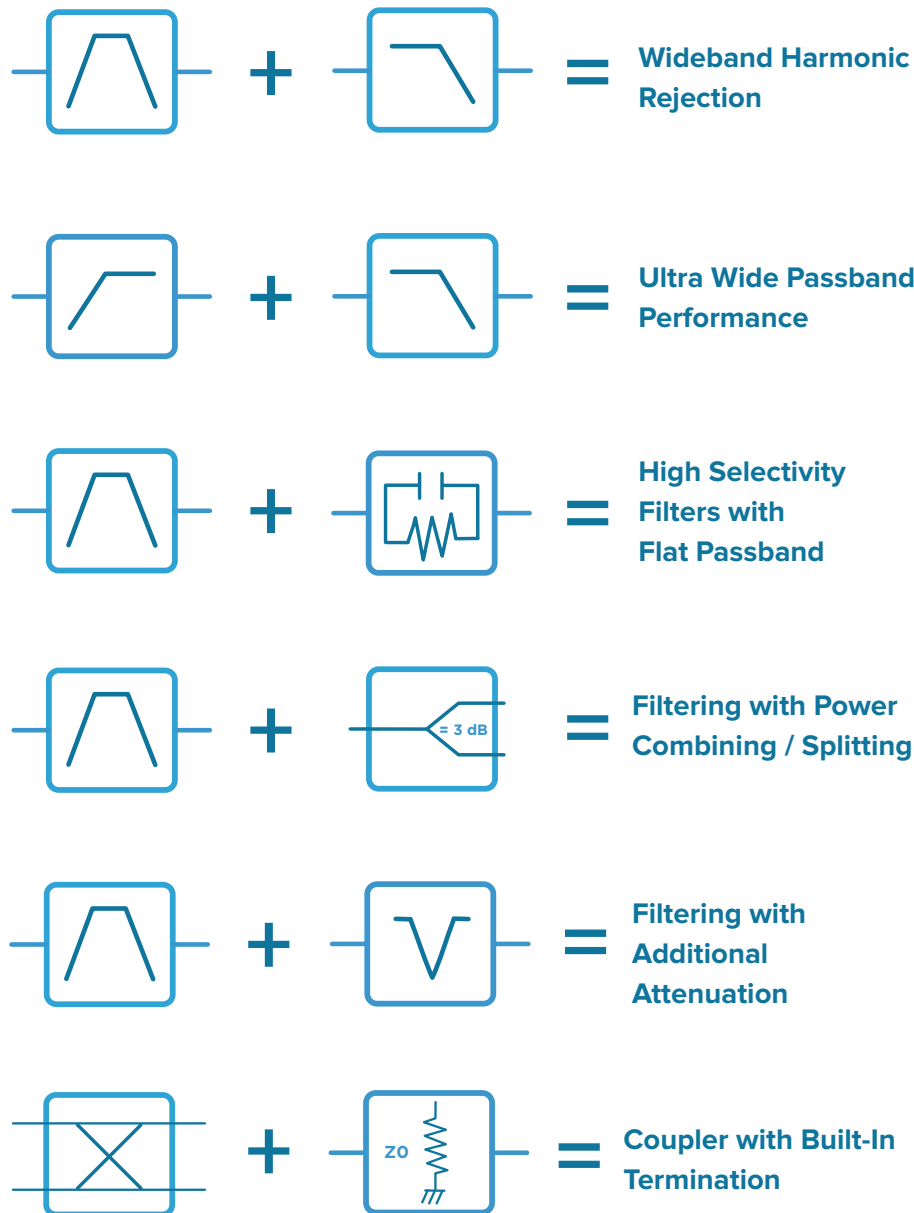

$\text{[n-Way Power Divider]} = \text{Reduced Footprint, Repeatable Performance N - Way Power Combiners / Dividers}$



Integrated R-C Networks

BIAS FILTER NETWORK

Knowles Precision Devices takes advantage of the high permittivity ceramics offered by the DLI brand combined with thin film resistors to provide Unique Bias Filter products. Bias Filter Networks provide high attenuation (>40dB, 300 MHz to 40 GHz) of unwanted RF signals on DC Bias lines. They are designed for applications with low current, such as gate bias of an FET or MMIC. RF energy is bypassed to RF ground. Bias Filters are designed for conductive epoxy attachment directly to the Ground plane (module floor) of Chip & wire modules. DC current rating: 10 mA max.

EQUIVALENT SCHEMATIC REPRESENTATION:

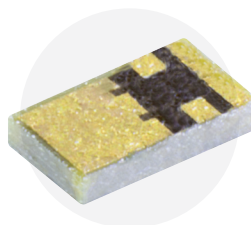
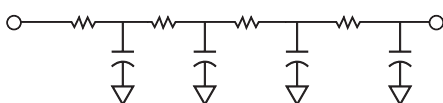

PART NUMBERS

Full PN	Cap Range (pF)	Resist	Width (in)	Length (in)	Thickness (in)
B20BHSBN01	40 to 90	100 ± 20%	.020 ± .001	.034 ± .001	.006 ± .001
B20BLSBN01	40 to 90	100 ± 20%	.020 ± .001	.034 ± .001	.006 ± .001
B28BHFBN01	76 to 171	600 ± 20%	.028 ± .001	.053 ± .001	.007 ± .001

SELF BIAS NETWORK

Knowles Precision Devices takes advantage of the high-permittivity ceramics offered by the DLI brand combined with thin film resistors to provide a device that integrates source decoupling and user-selectable bias resistance.

The technique is commonly referred to as a self-bias GaAs FET amplifier – this enables the use of a single DC supply voltage. The gate is at DC ground potential and a negative Vgs is provided by the voltage drop across the selected wire-bond resistors from source to ground – thus setting the desired drain bias current (IDS).

The chip network is designed for epoxy attachment to a ground Ridge, one on either side of an FET chip transistor. This provides symmetric, minimum reactance to ground source bypassing for optimum FET gain. By selectively wire bonding from resistor pads to ground, the pair of networks used for each FET provides a wide range of Resistance combinations. The Self Bias Networks, used as a pair, replace 2 standard Parallel plate capacitors and a separate set of bias resistors, reducing parts count, assembly and size.

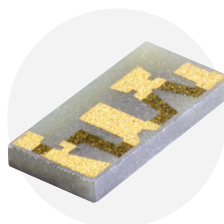

EQUIVALENT SCHEMATIC REPRESENTATION:

User wire bond to Ground to select resistance.

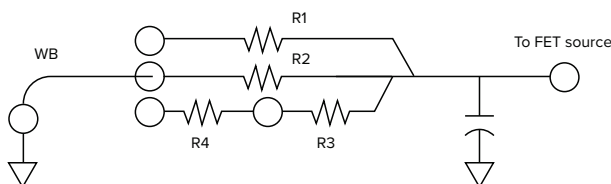

Resistor Values:

R1 - 200Ω R3 - 50Ω
R2 - 100Ω R4 - 20Ω

Nominal Capacitance:

50pF

PART NUMBERS

Full PN	Cap Range (pF)	Resist	Width (in)	Length (in)	Thickness (in)
B28BJBFN01	76 to 171	600 ± 20%	.028 ± .001	.053 ± .001	.007 ± .001
B28BTBFN01	112 to 168	600 ± 20%	.028 ± .001	.053 ± .001	.007 ± .001

TYPICAL APPLICATIONS

- Wireless communication modules
- Ideal varactor decoupling element
- High gain RF/Microwave modules
- Ideal GaAs FET gate biasing device
- MMIC multichip modules
- MIC broadband high gain RF/Microwave modules
- Bias line voltage divider and integrated decoupling capacitor

CERTIFICATION:



Integrated R-C Networks

C-R-C DECOUPLING NETWORKS

(aka. RF Blocking Networks)

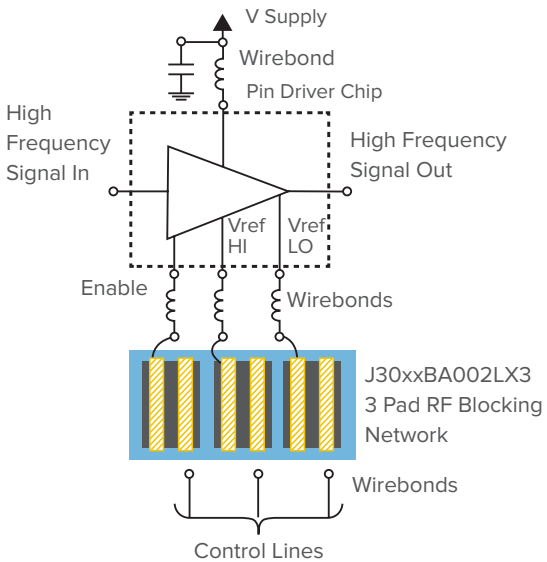

SEGMENT EQUIVALENT SCHEMATIC REPRESENTATION

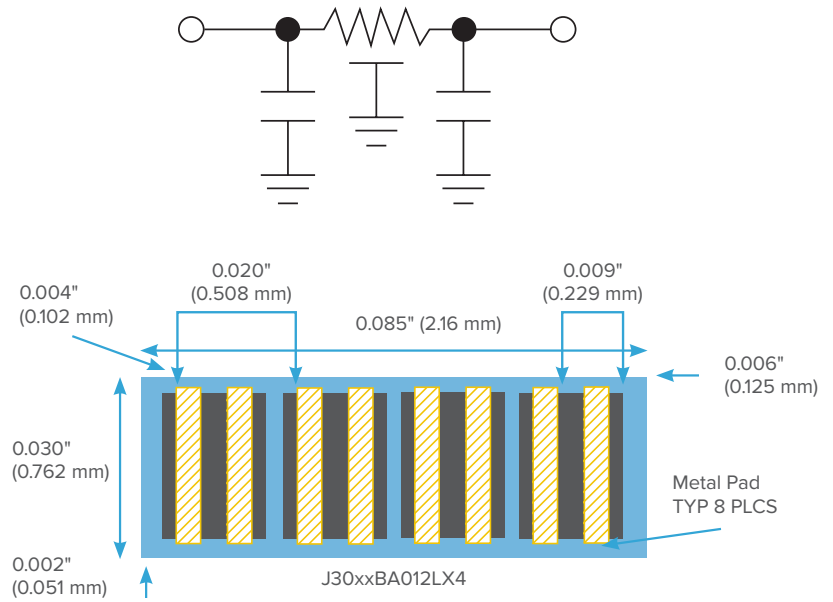

Part Number J30BLBA032LX1 J30BLBA022LX2 J30BLBA002LX3 J30BLBA012LX4 J30BJBA032LX1 J30BJBA022LX2 J30BJBA002LX3 J30BJBA012LX4

Number of RC Segments	1	2	3	4	1	2	3	4
Nominal Resistance (pad to pad) (Ω)	10	10	10	10	10	10	10	10
Capacitance (typical) (pF)	30	30	30	30	45	45	45	45
Maximum DF	3.00%	3.00%	3.00%	3.00%	3.00%	3.00%	3.00%	3.00%
TCC	X7R	X7R	X7R	X7R	X7R	X7R	X7R	X7R
Rated Voltage (Vdc)	25	25	25	25	25	25	25	25
Attachment Method	All are configured for Chip & Wire attachment							
Termination Finish	100 μ inches Au, minimum							
Dimensions (inches)								
Length	0.025	0.045	0.065	0.085	0.250	0.045	0.065	0.085
Width	0.030	0.030	0.030	0.030	0.030	0.030	0.030	0.030
Dimensions (mm)								
Length	0.64	1.14	1.65	2.16	6.35	1.14	1.65	2.16
Width	0.76	0.76	0.76	0.76	0.76	0.76	0.76	0.76

Power Dividers

DLI brand power dividers incorporate low-loss, high-permittivity ceramics, providing miniaturized dimensions and temperature-stable RF performance. The integrated thin film resistors improve phase and amplitude balance over broadband devices. There are two styles: Wilkinson and resistive power dividers, and these designs are configured for attachment with either solder or conductive adhesive. Due to their compact size and proven performance, DLI brand power dividers are a superior option over integration in a soft board material with discrete resistors.

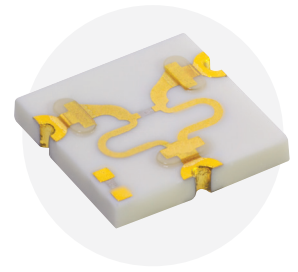

Above: Example of a Wilkinson Power Divider PDW



DESIGN ADVANTAGES:

- Small size
- Solder surface mountable
- Excellent repeatability
- Versions available



APPLICATIONS:

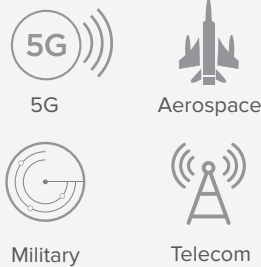

KEY CHARACTERISTICS:

- Low excess insertion loss
- High isolation
- Excellent phase and amplitude balance for Wilkinson Power Dividers only
- Well-matched on all ports

CERTIFICATION:

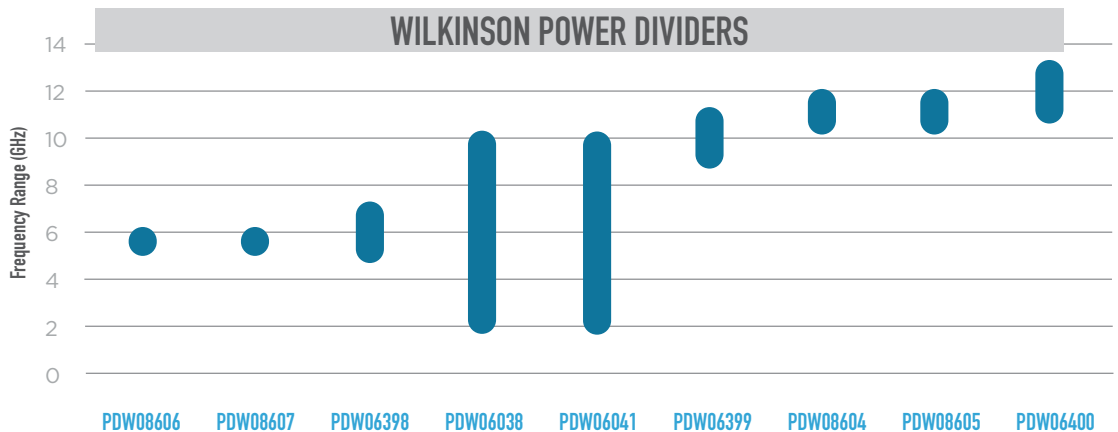

Part Number	PDW08606	PDW08607	PDW06398	PDW06038	PDW06041	PDW06399	PDW08604	PDW08605	PDW06400
Configuration	2:1	4:1	2:1	2:1	2:1	2:1	2:1	4:1	2:1
Nominal Power Splitting	3dB	6dB	3dB	3dB	3dB	3dB	3dB	6dB	3dB
Freq. Low (GHz)	5.3	5.3	5	2	2	9	10.6	10.6	11
Freq. High (GHz)	5.9	5.9	7	10	10	11	11.8	11.8	13
Max. Amplitude Balance (dB)	±0.15	±0.25	±0.20	±0.25	±0.25	±0.1	±0.25	±0.25	±0.25
Max. Phase Balance (degrees)	±2.5	±2.5	±3.0	±5.0	±5.0	±1.0	±1.75	±5.0	±4.0
Typical Excess Insertion Loss (dB)	0.3	0.5	0.25	1.25	1.25	0.4	0.4	0.4	0.5
Typical Return Loss (dB)	20	16	20	20	20	20	15	20	25
Typical Isolation (dB)	20	20	18	20	20	18	15.5	20	20
Mounting	SMD				Chip & Wire	SMD			
Length (inches)	0.115	0.260	0.120	0.400	0.400	0.150	0.085	0.190	0.130
Width (inches)	0.115	0.175	0.240	0.250	0.250	0.100	0.085	0.125	0.130
Height (inches)	0.030	0.030	0.015	0.020	0.020	0.015	0.020	0.020	0.015
Length (mm)	2.921	6.604	3.048	10.16	10.16	3.81	2.159	4.826	3.302
Width (mm)	2.921	4.445	6.096	6.35	6.35	2.54	2.159	3.175	3.302
Height (mm)	0.762	0.762	0.381	0.508	0.508	0.381	0.508	0.508	0.381



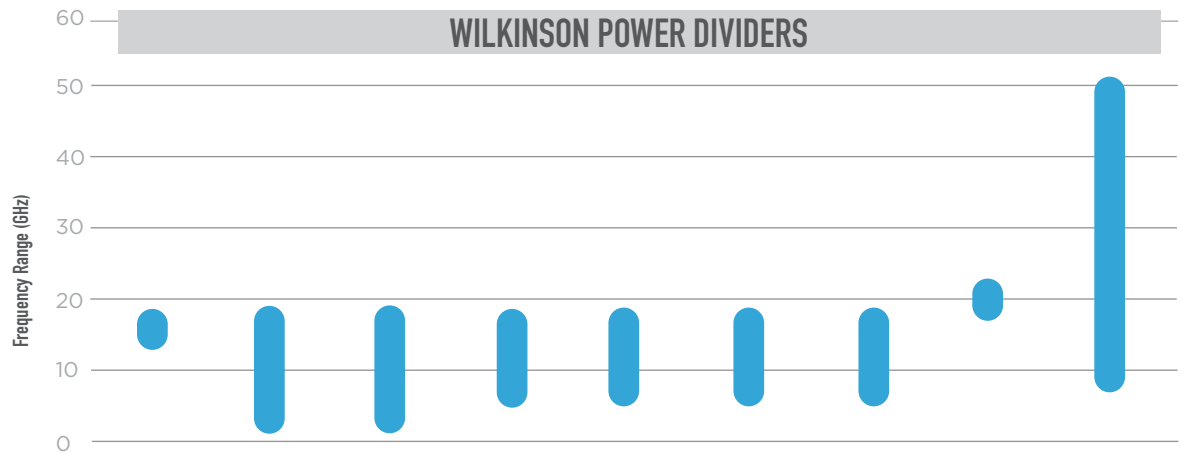

Part Number PDW06401 PDW06407 PDW06933 PDW05758 PDW06011 PDW06089 PDW07948 PDW07691 PDW09692

Configuration	2:1	2:1	2:1	2:1	2:1	4:1	4:1	2:1	2:1
Nominal Power Splitting	3dB	3dB	3dB	3dB	3dB	6dB	6dB	3dB	3dB
Freq. Low (GHz)	15	2	2	6	6	6	6	18	8
Freq. High (GHz)	17	18	18	18	18	18	18	20	50
Max. Amplitude Balance (dB)	±0.1	±0.6	±0.6	±0.5	±0.5	±0.75	±0.75	±0.25	±0.7
Max. Phase Balance (degrees)	±2.0	±8.0	±8.0	±1.25	±1.25	±9.0	±9.0	±1.25	±10
Typical Excess Insertion Loss (dB)	0.25	2.5	2.5	2.35	0.9	0.8	0.8	0.25	0.50
Typical Return Loss (dB)	20	18	18	20	16	15	15	20	17
Typical Isolation (dB)	20	20	20	25	25	20	20	20	20
Mounting	SMD		Chip & Wire	SMD	Chip & Wire	SMD	Chip & Wire	SMD	
Length (inches)	0.120	0.600	0.600	0.185	0.185	0.250	0.250	0.100	0.220
Width (inches)	0.120	0.180	0.180	0.160	0.160	0.300	0.300	0.100	0.080
Height (inches)	0.015	0.020	0.020	0.020	0.020	0.020	0.020	0.015	0.010
Length (mm)	3.048	15.24	15.24	4.699	4.699	6.35	6.35	2.54	5.59
Width (mm)	3.048	4.572	4.572	4.064	4.064	7.62	7.62	2.54	2.03
Height (mm)	0.381	0.508	0.508	0.508	0.508	0.508	0.508	0.381	0.25

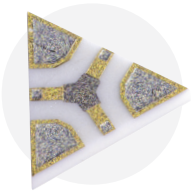

Above: Example of a Resistive Power Divider PDR (note: shows mounting configuration on bottom side of the part)

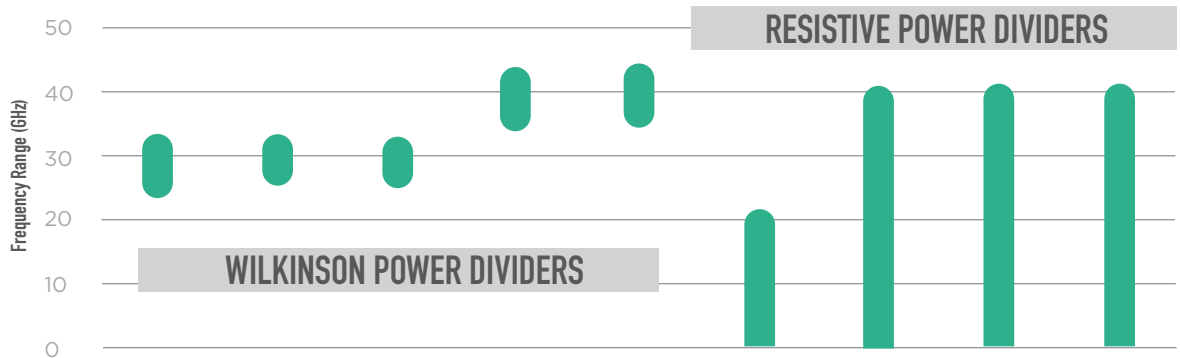

Part Number PDW07069 PDW06984 PDW07630 PDW08323 PDW08324 PDR06390 PDR05848 PDR06120 PDR06380

Configuration	4:1	2:1	2:1	2:1	4:1	2:1	2:1	2:1	2:1
Nominal Power Splitting	6dB	3dB	3dB	3dB	6dB	6dB	6dB	6dB	6dB
Freq. Low (GHz)	24	25	25	37	37	0	0	0	0
Freq. High (GHz)	32	32	32	42	42	20	40	40	40
Max. Amplitude Balance (dB)	±0.25	±0.25	±0.25	±0.5	±0.75	±0.6	±0.6	±0.6	±0.6
Max. Phase Balance (degrees)	±5.0	±2.5	±5.0	±5.75	±5.0	±3.0	±3.0	±3.0	±3.0
Typical Excess Insertion Loss (dB)	1	0.6	0.25	0.75	0.75	0.25	0.5	0.5	0.5
Typical Return Loss (dB)	15	15	17	15	15	20	20	20	20
Typical Isolation (dB)	20	15	15	20	25	6	6	6	6
Mounting	SMD					SMD (AuSn)		Epoxy	SMD
Length (inches)	0.140	0.085	0.070	0.070	0.140	0.075	0.075	0.075	0.075
Width (inches)	0.170	0.095	0.070	0.070	0.170	0.070	0.065	0.065	0.065
Height (inches)	0.010	0.010	0.010	0.010	0.010	0.010	0.010	0.010	0.010
Length (mm)	3.556	2.159	1.778	1.78	3.56	1.91	1.905	1.905	1.905
Width (mm)	4.318	2.413	1.778	1.78	4.32	1.78	1.651	1.651	1.651
Height (mm)	0.254	0.254	0.254	0.25	0.25	0.25	0.254	0.254	0.254



Couplers

The high-frequency directional couplers incorporate DLI's high-permittivity ceramic materials to provide small size and minimal performance variation over temperature.

These couplers offer a turnkey solution in SMD or chip and wire format for high-frequency power monitoring, with the SMD series covering up to 40 GHz.

While custom coupling values are achievable, 3, 10, and 20 dB offerings are available with common footprints for maximum flexibility.

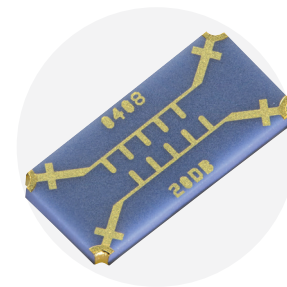

DESIGN ADVANTAGES:

- 30 times smaller than waveguide technology
- 0.8 x 0.2 x 0.03 inch for 10 GHz filter
- Wilkinson



APPLICATIONS:

- Wireless communications modules



KEY CHARACTERISTICS:

- High directivity
- Characteristic impedance: 50Ω
- Multiple PCB feed line configurations
- MSL 1

RESISTIVE COUPLERS

Part Number	Frequency Range GHz	Mean Coupling Value (dB)	Max Insertion Loss (dB)	Return Loss Typ. (dB)	Length Inches (mm)	Width Inches (mm)	Height Inches (mm)
FPC06882	DC to 25	25	2	12	0.0600 (15.24)	0.088 (2.235)	0.010 (2.54)
FPC06881	DC to 25	20	2.85	12	0.0600 (15.24)	0.088 (2.235)	0.010 (2.54)
FPC07802	DC to 40	30	2.5	12	0.0600 (15.24)	0.088 (2.235)	0.010 (2.54)
FPC07803	DC to 40	20	3	12	0.0600 (15.24)	0.088 (2.235)	0.010 (2.54)

CERTIFICATION:



Part Number	Fl (GHz)	Fh (GHz)	Coupling (dB)	Passband Coupling Variation Typ. (dB)	Excess Insertion Loss Typ. (dB)	Return Loss Typ. (dB)	Isolation Typ. (dB)	Directivity Typ. (dB)	Mounting Type	Length (in)	Width (in)	Height (in)	Length (mm)	Width (mm)	Height (mm)
FPC06700	5.9	6.5	3	±1	0.75	17	20	17	SMD	0.425	0.250	0.020	10.80	6.35	0.51
FPC06630	9	11	3	±1	0.5	20	18	15	SMD	0.286	0.180	0.015	7.26	4.57	0.38
FPC06701	10.7	12.75	3	±1	0.5	12	15	12	SMD	0.255	0.155	0.015	6.48	3.94	0.38
FPC07183	24	33	3	±1	1	12	15	12	SMD	0.180	0.110	0.010	4.57	2.79	0.25
FPC07234	2	18	10	±1.5	0.8	12	20	10	SMD	0.500	0.150	0.030	12.70	3.81	0.76
FPC09291	2	18	10	±1.5	0.8	12	20	10	Chip and Wire	0.500	0.150	0.030	12.70	3.81	0.76
FPC06073	4	8	10	±0.75	0.3	20	32	22	SMD	0.170	0.080	0.015	4.32	2.03	0.38
FPC06149	4	8	10	±0.75	0.5	15	30	20	Chip and Wire	0.180	0.080	0.015	4.57	2.03	0.38
FPC06719	6	18	10	±1.0	0.5	15	23	13	SMD	0.255	0.100	0.015	6.48	2.54	0.38
FPC07643	6	18	10	±1.0	0.5	15	23	13	Chip and Wire	0.255	0.100	0.015	6.48	2.54	0.38
FPC06074	8	12	10	±0.2	0.5	20	30	20	SMD	0.120	0.080	0.015	3.05	2.03	0.38
FPC06150	8	12	10	±1.5	1	12	24	14	Chip and Wire	0.130	0.090	0.015	3.30	2.29	0.38
FPC06075	12	18	10	±1.25	0.3	15	25	14	SMD	0.100	0.080	0.015	2.54	2.03	0.38
FPC06151	12	18	10	±0.75	0.75	15	20	10	Chip and Wire	0.100	0.080	0.015	2.54	2.03	0.38
FPC07182	20	40	10	±1.5	0.3	10	23	13	SMD	0.065	0.050	0.010	1.65	1.27	0.25
FPC07180	2	18	20	±1.0	1	15	25	5	SMD	0.500	0.150	0.015	12.70	3.81	0.38
FPC06076	4	8	20	±2.5	0.75	20	35	15	SMD	0.170	0.080	0.015	4.32	2.03	0.38
FPC06152	4	8	20	±1.5	0.25	25	40	20	Chip and Wire	0.180	0.080	0.015	4.57	2.03	0.38
FPC06913	6	18	20	±1.0	0.3	18	30	10	SMD	0.180	0.110	0.015	4.57	2.79	0.38
FPC07337	6	18	20	±1	0.7	15	25	5	Chip and Wire	0.180	0.100	0.015	4.57	2.54	0.38
FPC06153	8	12	20	±1.25	0.2	20	35	15	Chip and Wire	0.130	0.090	0.015	3.30	2.29	0.38
FPC06302	8	12	20	±1.25	1	20	35	15	SMD	0.120	0.080	0.015	3.05	2.03	0.38
FPC06078	12	18	20	±0.75	0.3	23	35	15	SMD	0.100	0.080	0.015	2.54	2.03	0.38
FPC06154	12	18	20	±1.5	0.3	10	30	10	Chip and Wire	0.100	0.080	0.015	2.54	2.03	0.38
FPC07181	20	40	20	±1.5	0.3	12	30	10	SMD	0.065	0.050	0.010	1.65	1.27	0.25
FPC06077	8	12	25	±1.0	0.3	18	35	10	SMD	0.120	0.080	0.015	3.05	2.03	0.38



Gain Equalizers

The DLI brand of gain equalizers are designed to compensate for module gain slope. Excellent repeatable microwave performance is achieved by application of precision thin-film fabrication and high-permittivity ceramic materials. This unique design solution provides near ideal R-C frequency response that is far superior to “stacked R-C chip” assemblies.



DESIGN ADVANTAGES:

- Many designs smaller than 0402 case size
- Ease of integration
- Customization available



APPLICATIONS:

- Broadband Microwave modules: EW, ECM, ECCM
- Equalizer is utilized as a compensation circuit to correct for loss slope created by other circuit elements such as amplifiers



KEY CHARACTERISTICS:

- Superior microwave performance
- Reduced cost
- Flatten amplifier gain response
- Positive gain slope

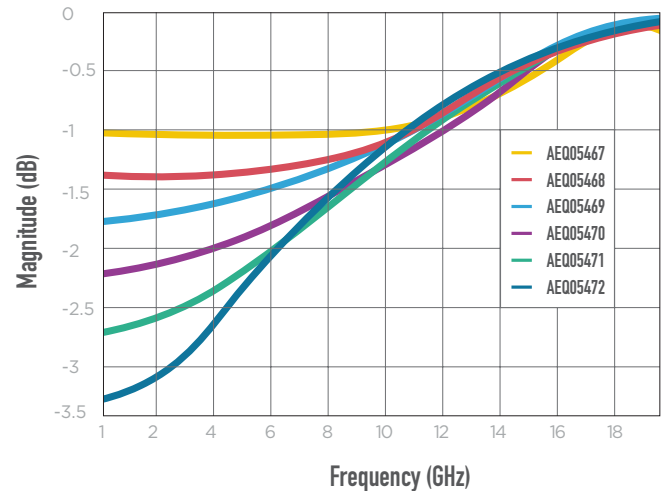
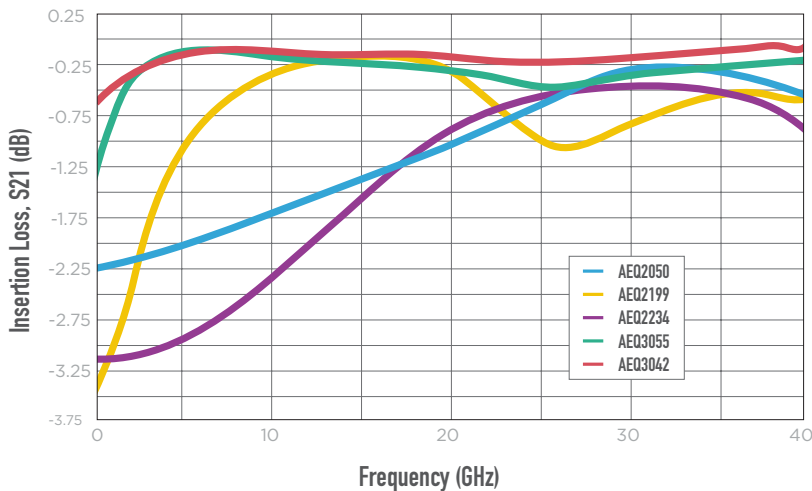

CERTIFICATION:



GAIN EQUALIZERS

Epoxy	Solderable	Lp	Wp	G	Nominal Slope	Length (mil)	Width (mil)	Thickness (mil)
AEQ2050	AEQ05510	9 ± 1	14 ± 1	8 ± 1	2.25 dB	30 ± 2	18 ± 2	5 ± 1
AEQ2199	AEQ05246	7 ± 1		12 ± 1	3.5 dB	28 ± 2	16 ± 2	7 ± 1
AEQ2234	AEQ06042	8 ± 1		12 ± 1	3.25 dB	32 ± 1		5 ± 1
AEQ3042	AEQ3042	17.5 ± 1	17.5 ± 1	3 ± 1	0.6 dB	40 ± 2	20 ± 2	6 ± 1
AEQ3055	AEQ3055	15.4 ± 1	18.4 ± 1	7.2 ± 1	1.5 dB			
AEQ05467	AEQ05467	7 min	14 ± 1	10	1.0 dB	28 ± 1	16 ± 1	7 ± 1
AEQ05468	AEQ05468				1.5 dB			
AEQ05469	AEQ05469				2.0 dB			
AEQ05470	AEQ05470				2.5 dB			
AEQ05471	AEQ05471				3.0 dB			
AEQ05472	AEQ05472				3.5 dB			

GAIN EQUALIZER KIT

Our Gain Equalizers offer gain slope compensation in a single component.

Benefits include:

- Superior microwave performance
- Excellent repeatability
- Ease of assembly
- Custom designs
- Small size (0402 or smaller)
- Products up through 40GHz



	AEQ2050	AEQ02199	AEQ02234	AEQ03055	AEQ03042
Low Freq. Loss	2.2dB	3.0dB	3.5dB	1.6dB	0.8dB
Min. Loss Freq.	31.0GHz	15.0GHz	27.0GHz	5.0GHz	5.0GHz
Mounting Method	Epoxy	Epoxy	Epoxy	Solder	Solder

EW GAIN EQUALIZER KIT

Benefits include:

- Superior microwave performance
- Excellent repeatability
- Ease of assembly
- Custom designs
- Small size (0302)
- Designed for 2-18GHz application



	AEQ05467	AEQ05468	AEQ05469	AEQ05470	AEQ05471	AEQ05472
Low Freq. Loss	1.0dB	1.35dB	1.75dB	2.25dB	2.75dB	3.25dB
Min. Loss Freq.	18GHz	18GHz	18GHz	18GHz	18GHz	18GHz
Mounting Method	Solder/ Epoxy	Solder/ Epoxy	Solder/ Epoxy	Solder/ Epoxy	Solder/ Epoxy	Solder/ Epoxy



MMWAVE FILTERS:

Addressing the Challenges Presented by 5G

Based on decades of experience working with mmWave filtering solutions, Knowles Precision Devices has a product line of **mmWave filter solutions** based on DLI filter technology that addresses the challenges outlined below of working with 5G technology.

SHRINKING WAVELENGTHS

At 700MHz, the wavelength in free space is about 430mm, and at 2.6GHz, wavelengths are 115mm. Yet at 39GHz, wavelengths are only 7.7mm.

REDUCED SIZE OF RF FRONT END

As wavelength shrinks so do antenna sizes, and for arrays to avoid diffraction effects, antenna spacing needs to be similarly shrunk. Filters in RF front ends need to be compact.

INCREASE IN NUMBER OF PATHS RF FRONT END

The enabling technologies for mmWave, beam steering and massive MIMO, rely on arrays of antenna elements, which, in turn, rely on multiple RF paths per antenna element — further necessitating compact filtering components.

INCREASED TEMPERATURE

In dense board environments temperatures rise, and RF front ends need to operate at increased temperature and with inherent temperature stability.

INCREASED NEED FOR REPEATABLE PERFORMANCE

High-frequency circuits are sensitive to variations in performance from part to part. Repeatability in filter component performance is key to avoid costly "set-at-test" scenarios.

EVER-PRESENT NEED TO PERFORM

Filter components for mmWave RF front ends need to encompass all these factors, and they still need to perform to ensure the best spectral efficiency and rejection possible.

Using specialized topologies and material formulations, Knowles Precision Devices created off-the-shelf catalog designs available up to 42 GHz that are 20 times smaller than the current alternatives.



MMWAVE FILTER KEY FEATURES & BENEFITS:

- Filter size reduction of up to 20x
- Stable operation from -55°C to +125°C
- Precise manufacturing means no tuning
- Performance—very broad band, high rejection and low insertion loss

Specialty Kits

5G KIT

Knowles Precision Devices meet the 5G mmWave filter challenge through our DLI filter technology:

- Shrinking wavelengths
- Reduce size of RF front end
- Increase in number of RF paths in RF front end
- Increased temperature
- Increased need for repeatable performance



5G Kit 26GHz - B259MC1S

PART NUMBER	TYPE	FC (GHz)	FL (GHz)	FH (GHz)	INSERTION LOSS (@FC, dB 25°C)	L, INCHES (mm)	W, INCHES (mm)	H, INCHES (mm)
B259MC1S	26GHz Bandpass	25.9	24.25	27.5	3.5	0.2165 (5.4991)	0.090 (2.286)	0.070 (1.778)
DEB-B259MC1S	26GHz Bandpass, mounted on eval board	25.9	24.25	27.5	3.5			
B274MB1S	28GHz Bandpass	28	25	29.5	3.25	0.450 (11.43)	0.110 (2.794)	0.089 (2.2606)
B280LB0S	28GHz Bandpass	28	27	29	1.5	0.350 (8.89)	0.120 (3.048)	0.098 (2.4892)
B280LA0S	28GHz Bandpass	28	27.5	28.5	4	0.550 (13.97)	0.140 (3.556)	0.083 (2.1082)
FPC07182	20dB Coupler		20	40	0.3	0.065 (1.651)	0.050 (1.27)	0.010 (0.254)
FPC07181	10dB Coupler		20	40	0.6	0.065 (1.651)	0.050 (1.27)	0.010 (0.254)
PDW07069	4-way Power Divider		25	32	1	0.140 (3.556)	0.170 (4.318)	0.010 (0.254)
PDW07630	2-way Power Divider		25	32	0.25	0.070 (1.778)	0.070 (1.778)	0.010 (0.254)

5G Kit 28GHz - B274MB1S

PART NUMBER	TYPE	FC (GHz)	FL (GHz)	FH (GHz)	INSERTION LOSS (@FC, dB 25°C)	L, INCHES (mm)	W, INCHES (mm)	H, INCHES (mm)
B274MB1S	28GHz Bandpass	28	26.5	29.5	3.25	0.450 (11.43)	0.110 (2.794)	0.089 (2.2606)
DEB-B274MB1S	28GHz Bandpass, mounted on eval board	28	26.5	29.5	3.25			
B280LB0S	28GHz Bandpass	28	27	29	1.5	0.350 (8.89)	0.120 (3.048)	0.098 (2.4892)
B280LA0S	28GHz Bandpass	28	27.5	28.5	4	0.550 (13.97)	0.140 (3.556)	0.083 (2.1082)
PDW07069	4-way Power Divider		25	32	1	0.140 (3.556)	0.170 (4.318)	0.010 (0.254)
PDW07630	2-way Power Divider		25	32	0.25	0.070 (1.778)	0.070 (1.778)	0.010 (0.254)
FPC07182	20dB Coupler		20	40	0.3	0.065 (1.651)	0.050 (1.27)	0.010 (0.254)
FPC07181	10dB Coupler		20	40	0.6	0.065 (1.651)	0.050 (1.27)	0.010 (0.254)

5G Kit 39GHz - B385MDOS

PART NUMBER	TYPE	FC (GHz)	FL (GHz)	FH (GHz)	INSERTION LOSS (@FC, dB 25°C)	L, INCHES (mm)	W, INCHES (mm)	H, INCHES (mm)
B385MDOS	39GHz Bandpass	38.5	37	40	2.5	0.275 (6.985)	0.080 (2.032)	0.075 (1.905)
DEB-B385MDOS	39GHz Bandpass, mounted on eval board	38.5	37	40	2.5			
PDW08323	2-way Power Divider		37	42	0.5	0.070 (1.778)	0.070 (1.778)	0.010 (0.254)
PDW08324	4-way Power Divider		37	42	0.7	0.170 (4.318)	0.140 (3.556)	0.010 (0.254)
FPC07182	20dB Coupler		20	40	0.3	0.065 (1.651)	0.050 (1.27)	0.010 (0.254)
FPC07181	10dB Coupler		20	40	0.6	0.065 (1.651)	0.050 (1.27)	0.010 (0.254)



SatCom Offerings

C BAND

PART NUMBER	TYPE	FREQUENCY RANGE, GHz	SIZE L X W X H, INCHES (mm)
B056RC4S	Bandpass Filter Octave	4.0-8.0	0.450 (11.43) x 0.230 (5.842) x 0.100 (2.54)
B038NC4S	Bandpass Filter Downlink	3.4-4.2	0.550 (13.97) x 0.220 (5.588) x 0.108 (2.743)
B040RG9S	Bandpass Filter Downlink	2.0-6.0	0.620 (15.75) x 0.280 (7.11) x 0.093 (2.36)
B061MB6S	Bandpass Filter Downlink	5.85-6.425	0.450 (11.43) x 0.200 (5.08) x 0.098 (2.48)
PDW06398	Power Divider 2:1 Splitter	5.0-7.0	0.120 (3.048) x 0.240 (6.096) x 0.015 (0.381)
FPC06700	Directional Coupler 3 dB	5.9-6.5	0.425 (10.80) x 0.250 (6.35) x 0.020 (0.508)
FPC06073	Directional Coupler 10 dB	4.0-8.0	0.170 (4.318) x 0.080 (2.032) x 0.015 (0.381)
FPC06149	Directional Coupler 10 dB	4.0-8.0	0.180 (4.572) x 0.080 (2.032) x 0.015 (0.381)
FPC06076	Directional Coupler 20 dB	4.0-8.0	0.170 (4.318) x 0.080 (2.032) x 0.015 (0.381)
FPC06152	Directional Coupler 20 dB	4.0-8.0	0.180 (4.572) x 0.080 (2.032) x 0.015 (0.381)

X BAND

PART NUMBER	TYPE	FREQUENCY RANGE, GHz	SIZE L X W X H, INCHES (mm)
B096QC2S	Bandpass Filter Octave	8.0-12.0	0.400 (10.16) x 0.180 (4.572) x 0.100 (2.54)
PDW06399	Power Divider 2:1 Splitter	9.0-11.0	0.150 (3.81) x 0.100 (2.54) x 0.015 (0.381)
FPC06630	Directional Coupler 3 dB	9.0-11.0	0.286 (7.264) x 0.180 (4.572) x 0.015 (0.381)
FPC06074	Directional Coupler 10 dB	8.0-12.0	0.120 (3.048) x 0.080 (2.032) x 0.015 (0.381)
FPC06150	Directional Coupler 10 dB	8.0-12.0	0.130 (3.302) x 0.090 (2.286) x 0.015 (0.381)
FPC06153	Directional Coupler 20 dB	8.0-12.0	0.130 (3.302) x 0.090 (2.286) x 0.015 (0.381)
FPC06302	Directional Coupler 20 dB	8.0-12.0	0.120 (3.048) x 0.080 (2.032) x 0.015 (0.381)
FPC06701	Directional Coupler 3 dB	10.7-12.75	0.255 (6.48) x 0.155 (3.94) x 0.015 (0.381)

KU BAND

PART NUMBER	TYPE	FREQUENCY RANGE, GHz	SIZE L X W X H, INCHES (mm)
B119LB1S	Bandpass Filter Downlink	11.7-12.2	0.450 (11.43) x 0.200 (5.08) x 0.098 (2.488)
B119MB1S	Bandpass Filter Downlink	4.0-10.0	0.450 (11.43) x 0.200 (5.08) x 0.098 (2.488)
B142LA2S	Bandpass Filter Downlink	14.0-14.5	0.575 (14.60) x 0.200 (5.08) x 0.093 (2.36)
PDW06400	Power Divider 2:1 Splitter	11.0-13.0	0.130 (3.302) x 0.130 (3.302) x 0.015 (0.381)
PDW06401	Power Divider 2:1 Splitter	15.0-17.0	0.120 (3.048) x 0.120 (3.048) x 0.015 (0.381)
FPC06075	Directional Coupler 10 dB	12.0-18.0	0.100 (2.54) x 0.080 (2.032) x 0.015 (0.381)
FPC06151	Directional Coupler 10 dB	12.0-18.0	0.100 (2.54) x 0.080 (2.032) x 0.015 (0.381)
FPC06078	Directional Coupler 20 dB	12.0-18.0	0.100 (2.54) x 0.080 (2.032) x 0.015 (0.381)
FPC06164	Directional Coupler 20 dB	12.0-18.0	0.100 (2.54) x 0.080 (2.032) x 0.015 (0.381)

KA BAND

PART NUMBER	TYPE	FREQUENCY RANGE, GHz	SIZE L X W X H, INCHES (mm)
B289KA0S	Bandpass Filter Uplink	28.6-29.1	0.550 (13.97) x 0.140 (3.556) x 0.088 (2.235)
B291MB0S	Bandpass Filter Uplink	3.0-10.0	0.450 (11.43) x 0.140 (3.556) x 0.088 (2.235)
B305LA0S	Bandpass Filter Uplink	3.5-10.0	0.550 (13.97) x 0.140 (3.556) x 0.078 (1.981)
PDW06984	Power Divider 2:1 Splitter	25.0-32.0	0.085 (2.159) x 0.095 (2.413) x 0.010 (0.254)
PDW07069	Power Divider 4:1 Splitter	24.0-32.0	0.140 (3.556) x 0.170 (4.318) x 0.010 (0.254)
PDW07630	Power Divider 2:1 Splitter	25.0-32.0	0.070 (1.778) x 0.070 (1.778) x 0.010 (0.254)
FPC07182	Directional Coupler 10 dB	20.0-40.0	0.065 (1.651) x 0.050 (1.27) x 0.010 (0.254)
FPC07181	Directional Coupler 20 dB	20.0-40.0	0.065 (1.651) x 0.050 (1.27) x 0.010 (0.254)



User Guidelines: Chip and Wire or Hybrid Assembly

Some DLI brand parts are configured for chip and wire or hybrid assembly. This design enables a channelized assembly for parts recessed into boards. These filters will have a product code ending in “W”.

TYPICAL IMPLEMENTATION (REFER TO FIGURES)

- PCB design includes a cavity to allow the filter to be recessed
- Filter is attached to system ground plane using conductive epoxy
- Wire or ribbon bonds form RF connection from filter to PCB
- An optimal design will include a cover to protect RF performance
- CTE mismatch between the ceramic circuit and housing should be minimized

TERMINATION FINISH

Gold (100-200 μ inches)

SHIELDING

Recommended to protect RF performance, especially above 18GHz.

Covers can be requested, DLI engineering will make recommendations based on layout

MATERIAL RECOMMENDATIONS

- Conductive adhesive for the ground plane
- Wire or ribbon bonds for the I/Os

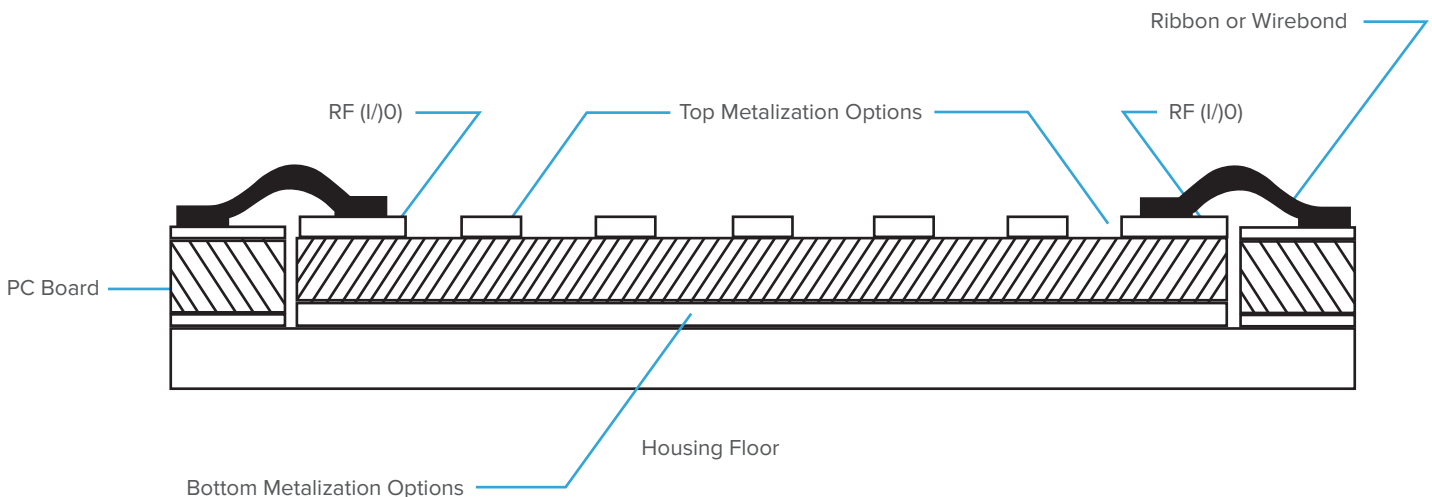

User Guidelines: Surface Mount

SURFACE MOUNT DEVICES (SMD) FOR SOLDER ATTACH

Many DLI brand parts are designed for solder attachment. This enables high volume production environments to assemble these parts just like any others in an automated surface mount line, with flexibility for low volume assembly as well. SMD filters will have a product code ending in “S”.

- Termination finish: ENIG, a solderable nickel layer covered with 3-6 μ inches of gold unless otherwise stated
- Shielding: All SMD filters have an integrated RF shielded cover
- PCB layout recommendations are shown in the figure below

ASSEMBLY RECOMMENDATIONS

- Performance is designed considering 2-3 mils finished solder standoff between the board and part once assembled
- Excess solder risks flowing up vias to invade the inside of the part, which will impact RF performance
- Stencil apertures should be designed with reduced area
- Preferred patterns avoid depositing solder paste over vias
- Solder is not intended to fill the castellation. Solder wetting will form a fillet; around 70% of the height of the castellation is acceptable
- It is recommended to use a profile as recommended by your solder material supplier

SOLDER MATERIAL RECOMMENDATIONS

Solder may be applied as a stencil printing paste, dispensed paste or hand soldered with cored wire. Contacting the ceramic substrate with a hot soldering iron may thermal shock the component, resulting in cracks. Reflow profiling should be conducted with a thermocouple nearby to ensure parts don't see excessively high temperatures.

Note: These parts may be reworked, but only at the risk of altering the intended RF performance.

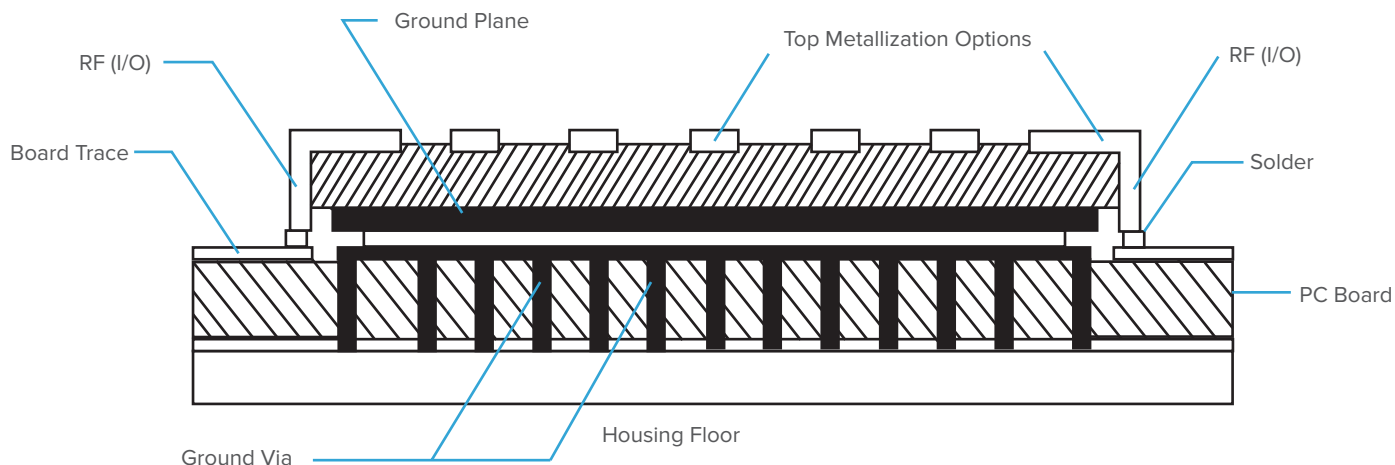

Reflow for Surface Mount

GENERAL REFLOW PROFILE RECOMMENDATIONS

Alloy Composition	Liquidus (°C)	Typical Peak Temp (°C)	Typical TAL (sec)	Typical Reflow Cycles
Eutectic Tin-Lead				
63Sn/37Pb	183	210 (max 230)	40-60 (max 90)	2
Near-Eutectic Tin-Lead				
62Sn/36Pb/2Ag	181	210 (max 230)	40-60 (max 90)	2
62.6Sn/37Pb/0.4Ag	182	210 (max 230)	40-60 (max 90)	2
60Sn/40Pb	191	220 (max 240)	40-60 (max 90)	2
Near-Eutectic Pb-free				
95.5Sn/3.8Ag/0.7Cu	220	240 (max 250)	30-60 (max 100)	2
96.5Sn/3Ag/0.5Cu	220	240 (max 250)	30-60 (max 100)	2
95.5Sn/4Ag/0.5Cu	225	245 (max 255)	30-60 (max 100)	2
98.5Sn/1Ag/0.5Cu	227	245 (max 255)	30-60 (max 100)	2

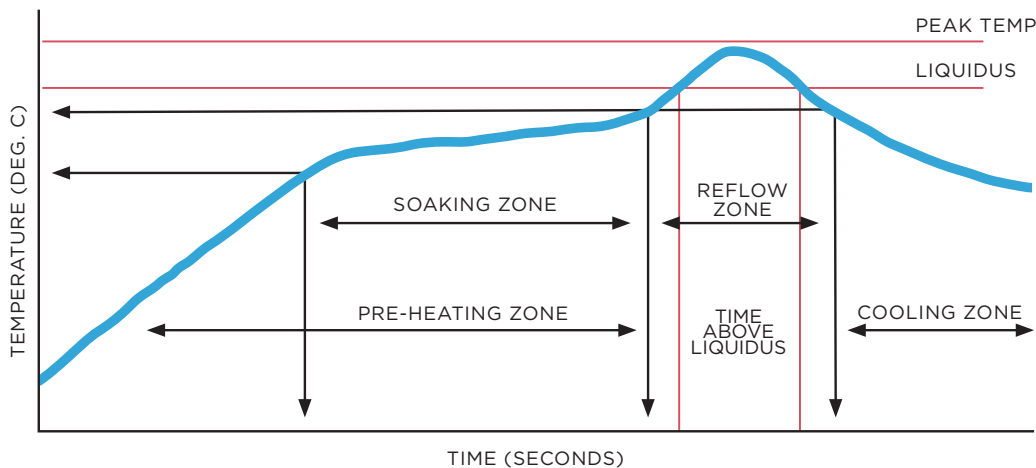

COMMENTS ON SOLDER ATTACH AND COMPONENT HANDLING:

1. Contact of a soldering iron directly to the ceramic filter may crack component due to thermal shock.
2. If using a hot plate for reflow, do not place board and filter directly on plate. The use of an alumina or stainless-steel slab directly on the hot plate will slow the rate of heat hitting the mounting assembly.
3. Plastic tipped tweezers or a vacuum pick-up tool are recommended for handling the components. Extra care should be taken not to scratch the filter or metal pattern.
4. Solder paste is typically applied by stencil. Typical solder joint thickness of 2-3 mils is recommended. Plugged ground vias in the PWB will improve attachment consistency.
5. Thin, unmounted circuit boards are prone to warpage during reflow. This can cause solder attach defects and cracking of filters during handling or subsequent housing installation.

