



BAS40-AU~BAS40S-AU

SURFACE MOUNT SCHOTTKY DIODES

Voltage	40 V	Current	0.2 A
----------------	-------------	----------------	--------------

Features

- Fast switching speed
- Surface mount package ideally suited for automatic insertion electrical identical standard JEDEC
- High conductor
- Lead free in compliance with EU RoHS 2.0
- Green molding compound as per IEC 61249 standard
- AEC-Q101 qualified

Mechanical Data

- Case: SOT-23 Package
- Terminals: Solderable per MIL-STD-750, Method 2026
- Approx. Weight: 0.0003 ounces, 0.0084 grams

SOT-23

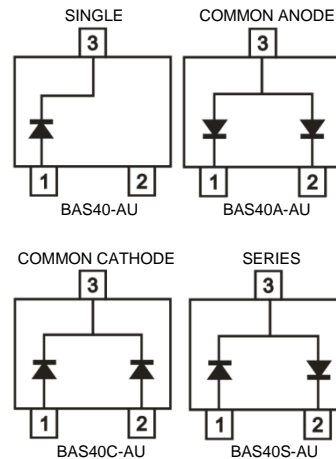
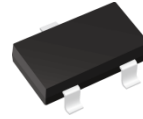

Maximum Ratings and Thermal Characteristics ($T_A = 25^\circ\text{C}$ unless otherwise noted)

PARAMETER	SYMBOL	LIMIT	UNITS
Maximum Repetitive Peak Reverse Voltage	V_{RRM}	40	V
Maximum Rms Voltage	V_{RMS}	28	V
Maximum Dc Blocking Voltage	V_{DC}	40	V
Maximum Average Forward Current	$I_{F(AV)}$	0.2	A
Peak Forward Surge Current : 1 s Single Half Sine-Wave Superimposed On Rated Load	I_{FSM}	0.6	A
Maximum Junction Capacitance Measured at 1 MHZ And Applied $V_R = 0\text{ V}$	C_J	5	pF
Typical Thermal Resistance	$R_{\theta JA}^{(1)}$	350	$^\circ\text{C/W}$
Operating Junction Temperature Range	T_J	-55~150	$^\circ\text{C}$
Storage Temperature Range	T_{STG}	-55~150	$^\circ\text{C}$



BAS40-AU~BAS40S-AU

Electrical Characteristics ($T_A = 25^\circ\text{C}$ unless otherwise noted)

PARAMETER	SYMBOL	TEST CONDITION	MIN.	TYP.	MAX.	UNITS
Forward Voltage	V_F	$I_F = 1\text{ mA}, T_J = 25^\circ\text{C}$	-	-	0.38	V
		$I_F = 10\text{ mA}, T_J = 25^\circ\text{C}$	-	-	0.50	
		$I_F = 40\text{ mA}, T_J = 25^\circ\text{C}$	-	-	1	
		$I_F = 1\text{ mA}, T_J = 125^\circ\text{C}$	-	0.21	-	
		$I_F = 10\text{ mA}, T_J = 125^\circ\text{C}$	-	0.35	-	
		$I_F = 40\text{ mA}, T_J = 125^\circ\text{C}$	-	0.55	-	
Reverse Current	$I_R^{(2)}$	$V_R = 30\text{ V}, T_J = 25^\circ\text{C}$	-	-	0.5	uA
		$V_R = 40\text{ V}, T_J = 25^\circ\text{C}$	-	-	1	
		$V_R = 40\text{ V}, T_J = 125^\circ\text{C}$	-	22	-	

NOTES:

1. Mounted on a FR4 PCB, single-sided copper, mini pad.
2. Short duration pulse test used to minimize self-heating effect



BAS40-AU~BAS40S-AU

TYPICAL CHARACTERISTIC CURVES

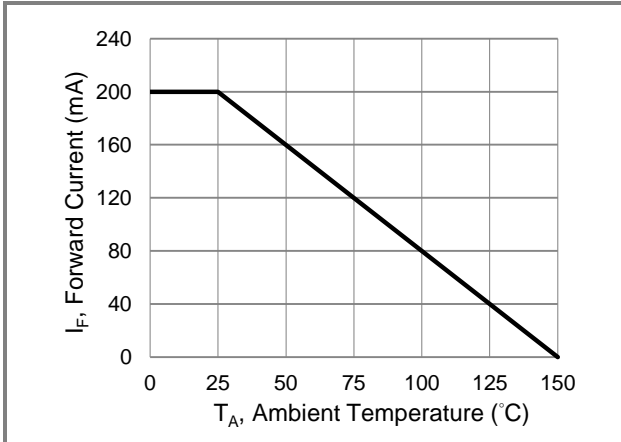

Fig.1 Forward Current Derating Curve

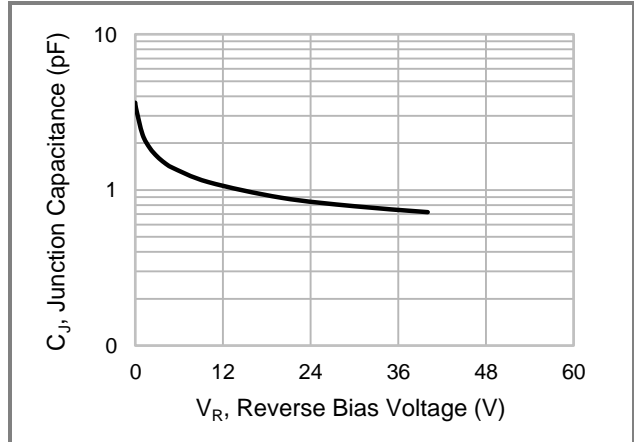

Fig.2 Typical Junction Capacitance

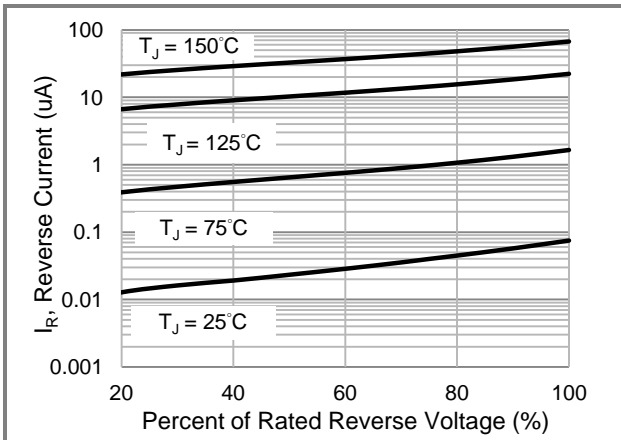

Fig.3 Typical Reverse Characteristics

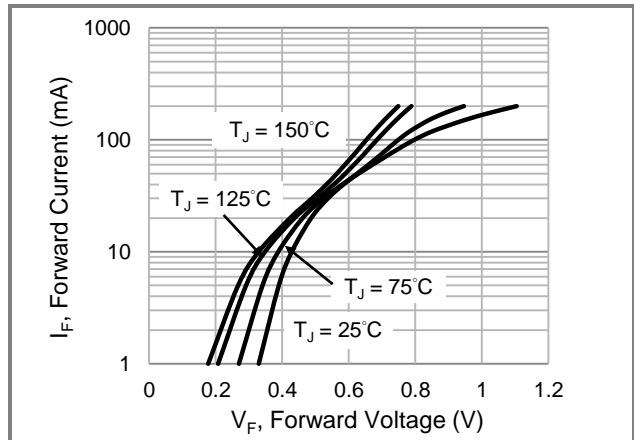

Fig.4 Typical Forward Characteristics

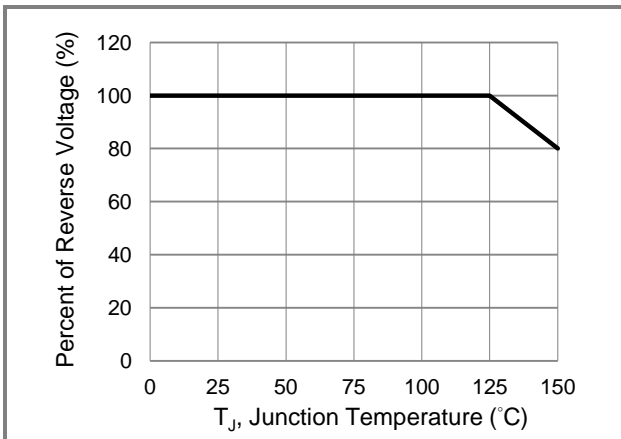

Fig.5 Operating Temperature Derating Curve



BAS40-AU~BAS40S-AU

Part No Packing Code Version

Part No Packing Code	Package Type	Packing Type	Marking	Version
BAS40-AU_R1_000A1	SOT-23	3K / 7" Reel	S40	Halogen free
BAS40A-AU_R1_000A1	SOT-23	3K / 7" Reel	S42	Halogen free
BAS40C-AU_R1_000A1	SOT-23	3K / 7" Reel	S43	Halogen free
BAS40S-AU_R1_000A1	SOT-23	3K / 7" Reel	S44	Halogen free

Packaging Information & Mounting Pad Layout

