



BAT54W-AU SERIES

SURFACE MOUNT SCHOTTKY DIODES

Voltage	30 V	Current	0.2 A
----------------	-------------	----------------	--------------

Features

- Low turn-on voltage
- Fast switching
- PN Junction Guard Ring for Transient and ESD Protection
- Lead free in compliance with EU RoHS 2.0
- Green molding compound as per IEC 61249 standard
- AEC-Q101 qualified

Mechanical Data

- Case: SOT-323 Package
- Terminals: Solderable per MIL-STD-750, Method 2026
- Approx. Weight: 0.0002 ounces, 0.005 grams

SOT-323

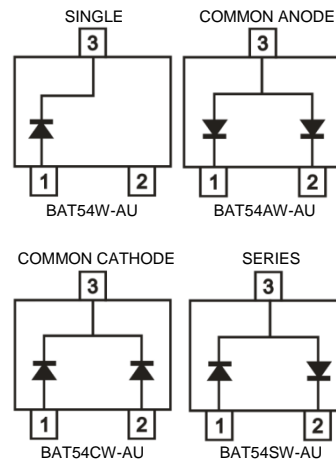
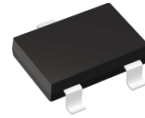

Maximum Ratings and Thermal Characteristics (T_A = 25 °C unless otherwise noted)

PARAMETER	SYMBOL	LIMIT	UNITS
Maximum Repetitive Peak Reverse Voltage	V _{RRM}	30	V
Maximum Rms Voltage	V _{RMS}	21	V
Maximum Dc Blocking Voltage	V _{DC}	30	V
Maximum Average Forward Current	I _{F(AV)}	0.2	A
Peak Forward Surge Current : 1 s Single Half Sine-Wave Superimposed On Rated Load	I _{FSM}	0.6	A
Typical Junction Capacitance Measured at 1 MHZ And Applied V _R = 1 V	C _J	10	pF
Typical Thermal Resistance	R _{θJA} ⁽¹⁾	540	°C/W
Operating Junction Temperature Range	T _J	-55~125	°C
Storage Temperature Range	T _{STG}	-55~125	°C



BAT54W-AU SERIES

Electrical Characteristics ($T_A = 25^\circ\text{C}$ unless otherwise noted)

PARAMETER	SYMBOL	TEST CONDITION	MIN.	TYP.	MAX.	UNITS
Forward Voltage	V_F	$I_F = 1\text{ mA}, T_J = 25^\circ\text{C}$	-	-	0.32	V
		$I_F = 100\text{ mA}, T_J = 25^\circ\text{C}$	-	-	0.60	
		$I_F = 1\text{ mA}, T_J = 125^\circ\text{C}$	-	0.14	-	
		$I_F = 100\text{ mA}, T_J = 125^\circ\text{C}$	-	0.47	-	
Reverse Current	$I_R^{(2)}$	$V_R = 24\text{ V}, T_J = 25^\circ\text{C}$	-	0.1	-	uA
		$V_R = 30\text{ V}, T_J = 25^\circ\text{C}$	-	-	2	
		$V_R = 30\text{ V}, T_J = 125^\circ\text{C}$	-	90	-	

NOTES:

1. Mounted on a FR4 PCB, single-sided copper, mini pad.
2. Short duration pulse test used to minimize self-heating effect



BAT54W-AU SERIES

TYPICAL CHARACTERISTIC CURVES

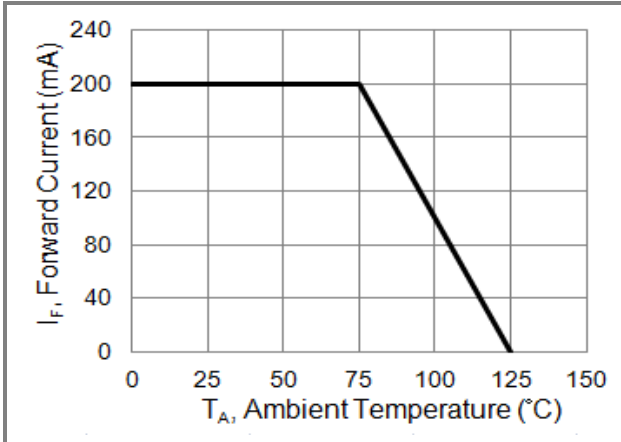

Fig.1 Forward Current Derating Curve

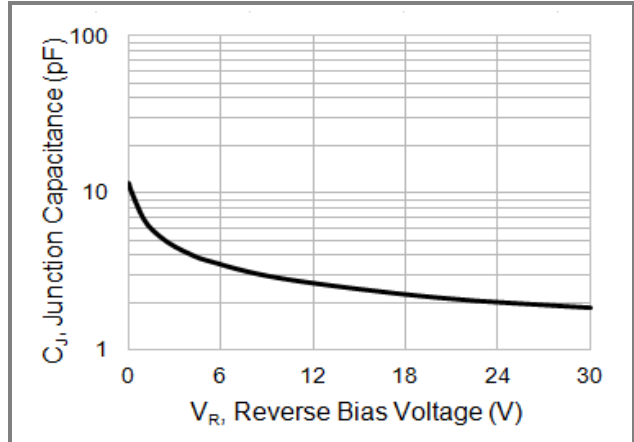

Fig.2 Typical Junction Capacitance

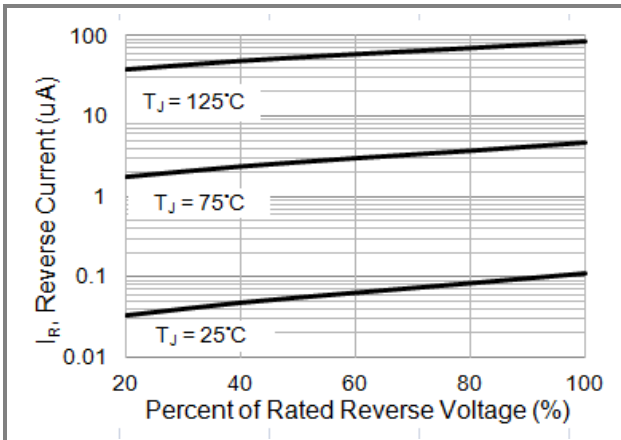

Fig.3 Typical Reverse Characteristics

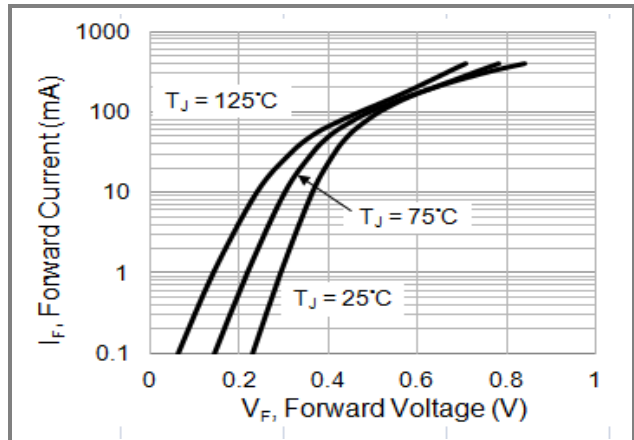

Fig.4 Typical Forward Characteristics

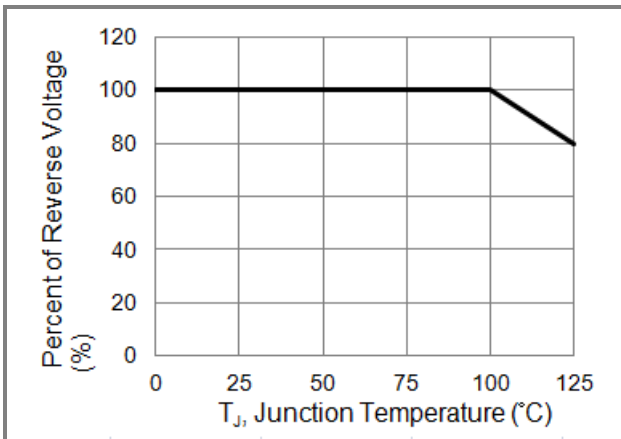

Fig.5 Operating Temperature Derating Curve



BAT54W-AU SERIES

Part No Packing Code Version

Part No Packing Code	Package Type	Packing Type	Marking	Version
BAT54W-AU_R1_000A1	SOT-323	3K / 7" Reel	L4	Halogen free
BAT54AW-AU_R1_000A1	SOT-323	3K / 7" Reel	L42	Halogen free
BAT54CW-AU_R1_000A1	SOT-323	3K / 7" Reel	L43	Halogen free
BAT54SW-AU_R1_000A1	SOT-323	3K / 7" Reel	L44	Halogen free

Packaging Information & Mounting Pad Layout

