

BC817-16-G/25-G/40-G (NPN) RoHS Device

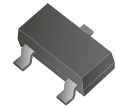

Features

- For general AF applications.
- High collector current.
- High current gain.
- Low collector-emitter saturation voltage.

Marking:

BC817-16-G: 6A
BC817-25-G: 6B
BC817-40-G: 6C

Diagram:

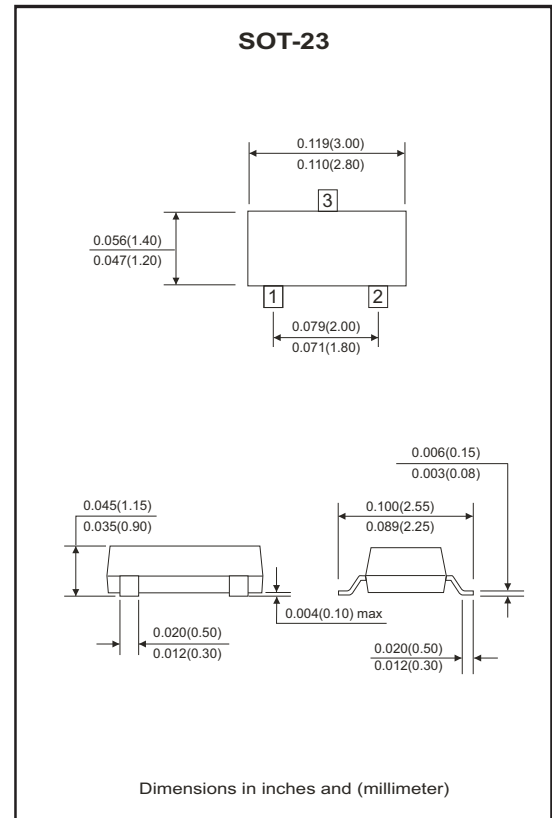
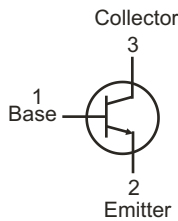

Maximum Ratings (at TA=25°C unless otherwise noted)

Parameter	Symbol	Value	Unit
Collector-Base voltage	V _{CBO}	50	V
Collector-Emitter voltage	V _{CEO}	45	V
Emitter-Base voltage	V _{EBO}	5	V
Collector current-continuous	I _C	500	mA
Collector power dissipation	P _C	300	mW
Junction and storage temperature range	T _J , T _{STG}	-55 to +150	°C

Electrical Characteristics (at TA=25°C unless otherwise noted)

Parameter	Symbol	Conditions	Min	Typ	Max	Unit
Collector-Base breakdown voltage	$V_{(BR)CBO}$	$I_C = 10\mu A, I_E = 0$	50			V
Collector-Emitter breakdown voltage	$V_{(BR)CEO}$	$I_C = 10mA, I_B = 0$	45			V
Emitter-Base breakdown voltage	$V_{(BR)EBO}$	$I_E = 1\mu A, I_C = 0$	5			V
Collector cut-off current	I_{CBO}	$V_{CB} = 45V, I_E = 0$			0.1	μA
Emitter cut-off current	I_{EBO}	$V_{EB} = 4V, I_C = 0$			0.1	μA
DC current gain	$h_{FE(1)}$	$V_{CE} = 1V, I_C = 100mA$	100		600	
	$h_{FE(2)}$	$V_{CE} = 1V, I_C = 500mA$	40			
Collector-Emitter saturation voltage	$V_{CE(SAT)}$	$I_C = 500mA, I_B = 50mA$			0.7	V
Base-Emitter saturation voltage	$V_{BE(SAT)}$	$I_C = 500mA, I_B = 50mA$			1.2	V
Base-Emitter voltage	$V_{BE(ON)}$	$V_{CE} = 1V, I_C = 500mA$			1.2	V
Collector capacitance	C_{ob}	$V_{CB} = 10V, f = 100MHz$		10		pF
Transition frequency	f_T	$V_{CE} = 5V, I_C = 10mA, f = 100MHz$	100			MHz

Classification of $h_{FE(1)}$

Rank	BC817-16-G	BC817-25-G	BC817-40-G
Range	100-250	160-400	250-600

RATING AND CHARACTERISTIC CURVES (BC817-16-G/25-G/40-G)

Fig.1 - Static Characteristic

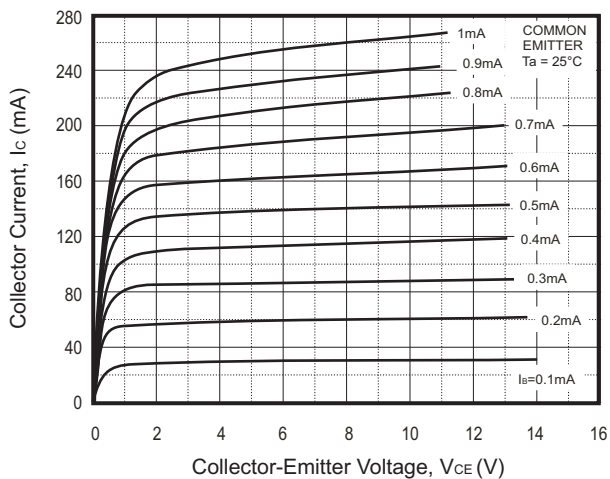
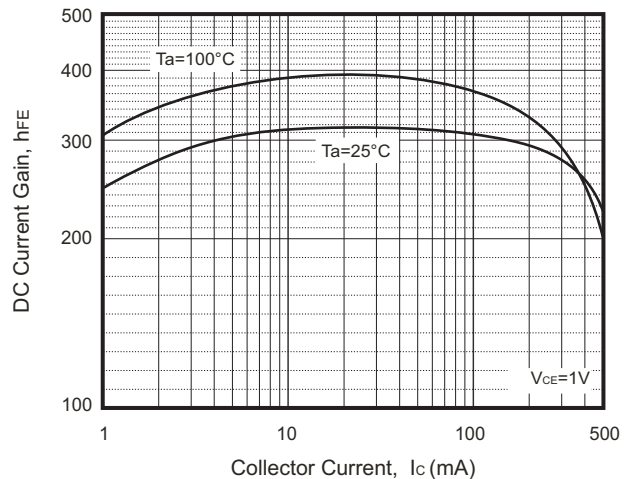

Fig.2 - $h_{FE} - I_C$



RATING AND CHARACTERISTIC CURVES (BC817-16-G/25-G/40-G)

Fig.3 - $V_{BEsat} - I_C$

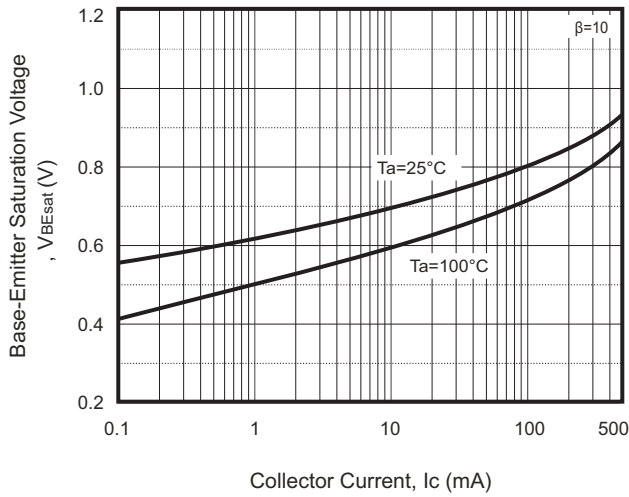

Fig.4 - $V_{CEsat} - I_C$

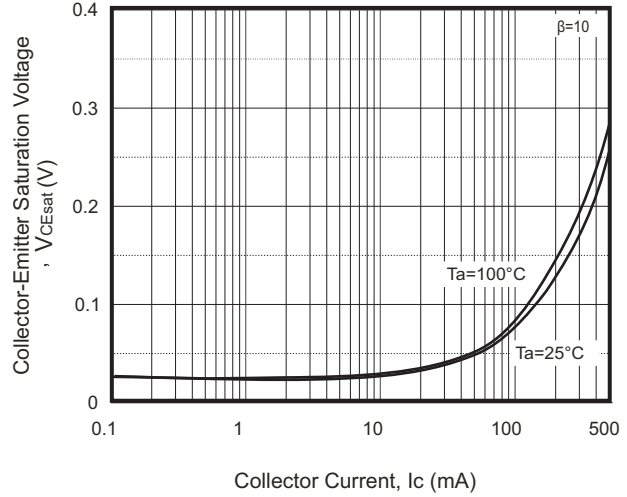

Fig.5 - $I_C - V_{BE}$

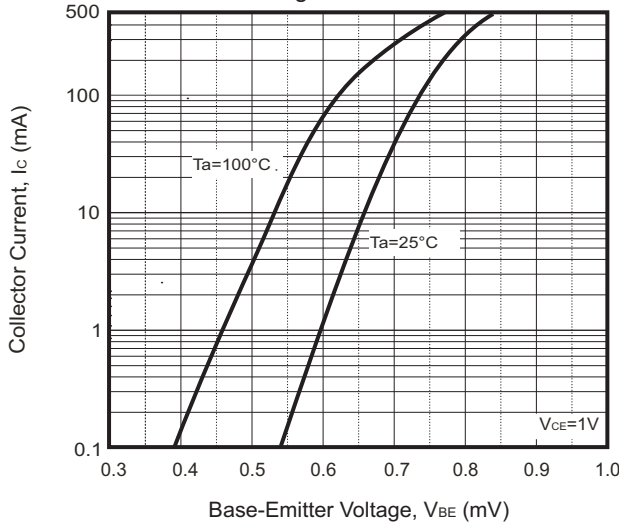

Fig.6 - $C_{ob}/C_{ib} - V_{CB}/V_{EB}$

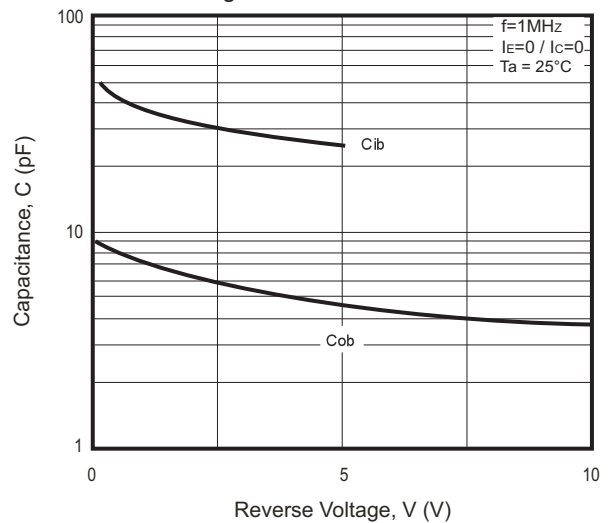

Fig.7 - $f_T - I_C$

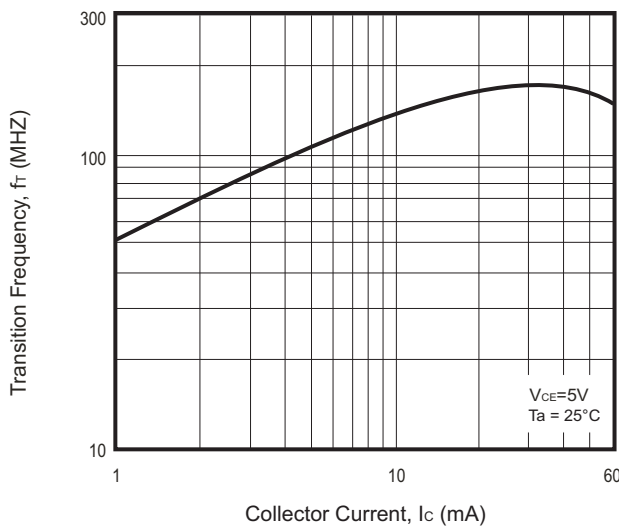
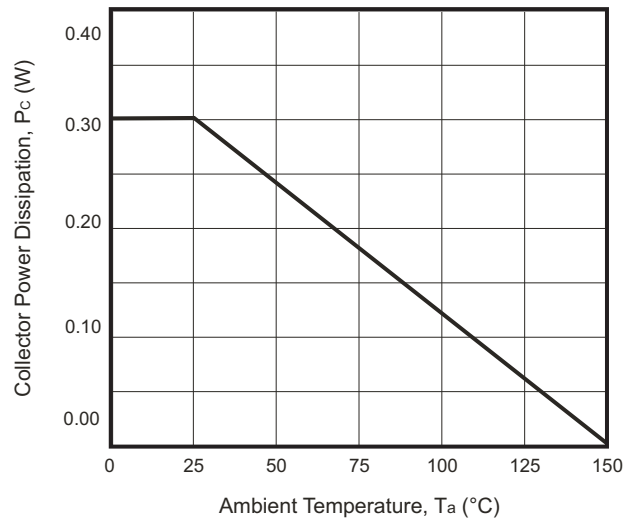
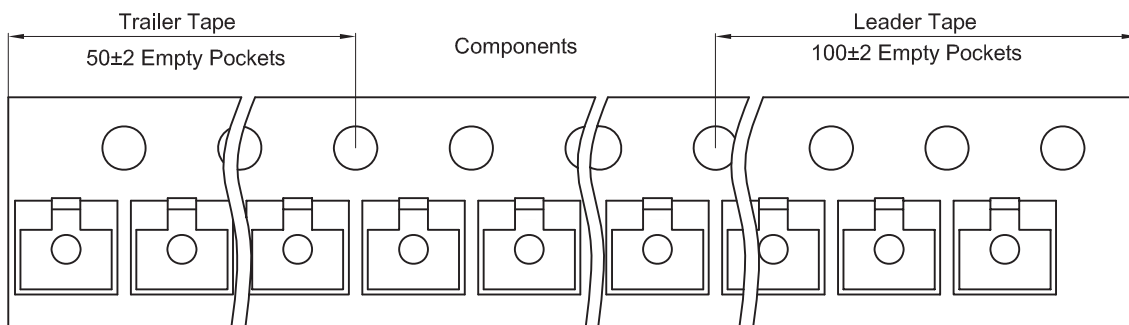
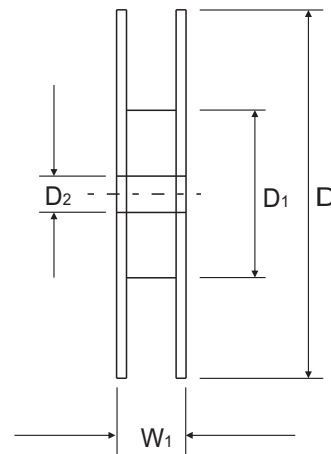
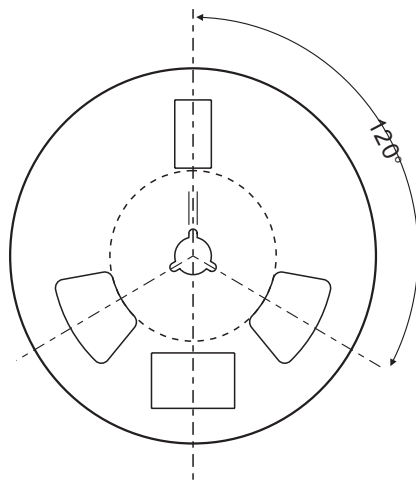
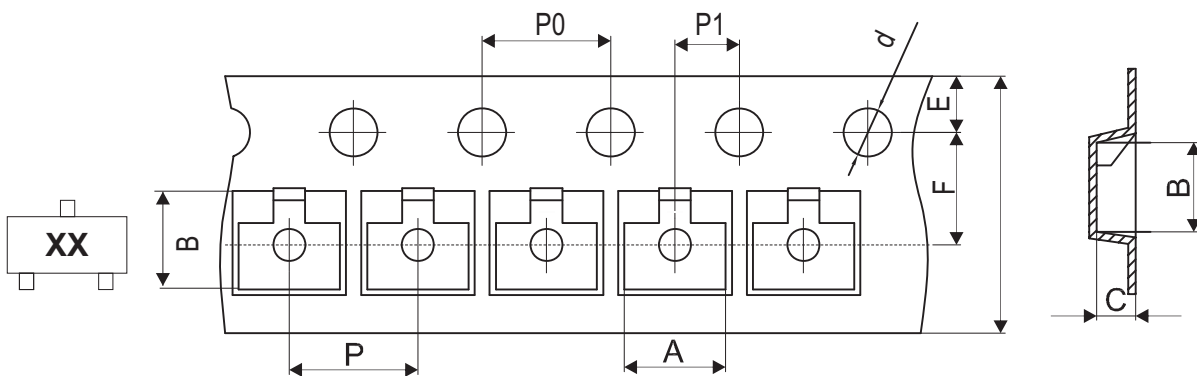

Fig.8 - $P_c - T_a$



Reel Taping Specification



SOT-23	SYMBOL	A	B	C	d	D	D1	D2
	(mm)	3.15 ± 0.10	2.77 ± 0.10	1.22 ± 0.10	1.50 ± 0.10	178.00 ± 2.00	54.40 ± 1.00	13.00 ± 1.00
	(inch)	0.124 ± 0.004	0.109 ± 0.004	0.048 ± 0.004	0.059 ± 0.004	7.008 ± 0.079	2.142 ± 0.039	0.512 ± 0.039

SOT-23	SYMBOL	E	F	P	P0	P1	W	W1
	(mm)	1.75 ± 0.10	3.50 ± 0.10	4.00 ± 0.10	4.00 ± 0.10	2.00 ± 0.10	8.00 + 0.30 / - 0.10	12.30 ± 1.00
	(inch)	0.069 ± 0.004	0.138 ± 0.004	0.157 ± 0.004	0.157 ± 0.004	0.079 ± 0.004	0.315 + 0.012 / - 0.004	0.484 ± 0.039