

## BC846AW-G Thru. BC848CW-G (NPN)

### RoHS Device

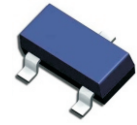

### Features

- Power dissipation  
PCM: 0.15W (@TA=25 °C)
- Collector current  
ICM: 0.1A
- Collector-base voltage  
VCBO: BC846W=80V  
BC847W=50V  
BC848W=30V
- Operating and storage junction temperature range: TJ, TSTG= -55 to +150 °C

### Mechanical data

- Case: SOT-323, molded plastic.
- Terminals: solderable per MIL-STD-750, method 2026.
- Approx. weight: 0.008 grams

### Circuit diagram

- 1.BASE
- 2.EMITTER
- 3.COLLECTOR

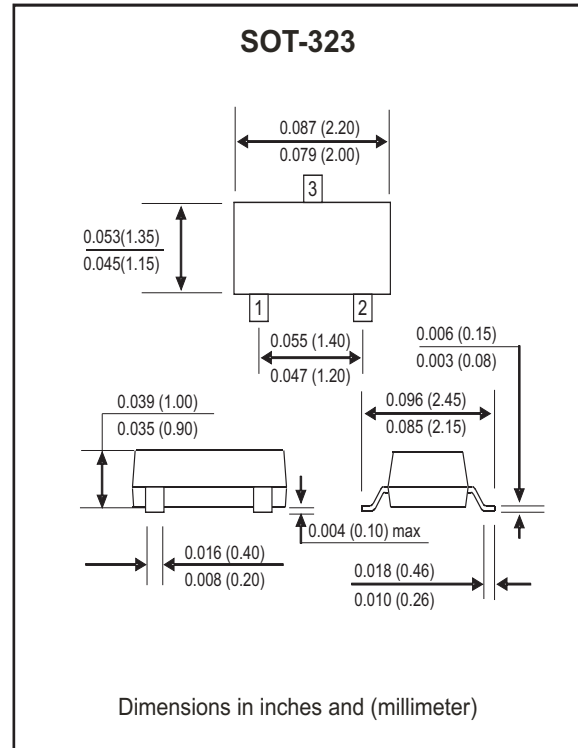
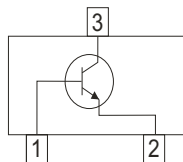

### Maximum Ratings (at Ta=25 °C unless otherwise noted)

Parameter	Symbol	Value	Units
Collector-Base Voltage	VCBO	80 50 30	V
Collector-Emitter Voltage	VCEO	65 45 30	V
Emitter-Base Voltage	VEBO	6 5	V
Collector Current -Continuous	IC	0.1	A
Collector Power Dissipation	PC	150	mW
Junction Temperature	TJ	150	°C
Storage Temperature Range	TSTG	-55 to +150	°C

# Small Signal Transistor



SMD Diodes Specialist

## Electrical Characteristics

(BC846AW-G Thru. BC848CW-G, @T<sub>A</sub>= 25°C unless otherwise specified)

Parameter	Symbol	Test Conditions	MIN	TYP	MAX	Units
Collector-Base Breakdown Voltage	BC846W-G BC847W-G BC848W-G	V <sub>CB0</sub>	I <sub>c</sub> = 10μA , I <sub>E</sub> =0	80 50 30		V
Collector-Emitter Breakdown Voltage	BC846W-G BC846W-G BC848W-G	V <sub>CEO</sub>	I <sub>c</sub> = 10mA , I <sub>B</sub> =0	65 45 30		V
Emitter-Base Break Voltage	BC846W-G, BC847W-G BC848W-G	V <sub>EBO</sub>	I <sub>E</sub> = 10μA , I <sub>c</sub> =0	6 5		V
Collector Cutoff Current		I <sub>cBO</sub>	V <sub>CB</sub> =30V		15	nA
DC Current Gain	BC846AW,847AW,848AW BC846BW,847BW,848BW BC847CW,848CW  BC846AW,847AW,848AW BC846BW,847BW,848BW BC847CW,848CW	h <sub>FE</sub>	V <sub>CE</sub> = 5V , I <sub>c</sub> =10μA  V <sub>CE</sub> = 5V , I <sub>c</sub> =2mA	  110 200 420	90 150 270  220 450 800	
Collector-Emitter Saturation Voltage		V <sub>CE(sat)</sub>	I <sub>c</sub> = 10mA , I <sub>B</sub> =0.5mA I <sub>c</sub> = 100mA , I <sub>B</sub> =0.5mA		0.25 0.60	V
Base-Emitter Saturation Voltage		V <sub>BE(sat)</sub>	I <sub>c</sub> = 10mA , I <sub>B</sub> =0.5mA I <sub>c</sub> = 100mA , I <sub>B</sub> =5mA		0.7 0.9	V
Base-Emitter Voltage		V <sub>BE(on)</sub>	V <sub>CE</sub> = 5V , I <sub>c</sub> =2mA V <sub>CE</sub> = 5V , I <sub>c</sub> =10mA	580	660 700 770	mV
Transition Frequency		f <sub>T</sub>	V <sub>CE</sub> =5V , I <sub>c</sub> =10mA f=100MHz	100		MHz
Collector Output Capacitance		C <sub>ob</sub>	V <sub>CB</sub> = 10V , f=1MHz		4.5	pF
Noise Figure	BC846AW,847AW,848AW BC846BW,847BW,848BW BC847CW,848CW	NF	V <sub>CE</sub> = 5V , I <sub>c</sub> =0.2mA f = 1KHz , R <sub>s</sub> =2KΩ BW=200Hz		10 4	dB

## Electrical Characteristic Curves (BC846AW-G Thru. BC848CW-G)

Fig.1 Normalized DC Current Gain

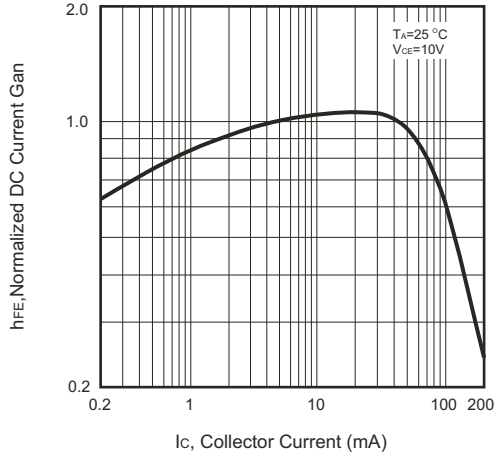

Fig.2 Saturation and On voltage

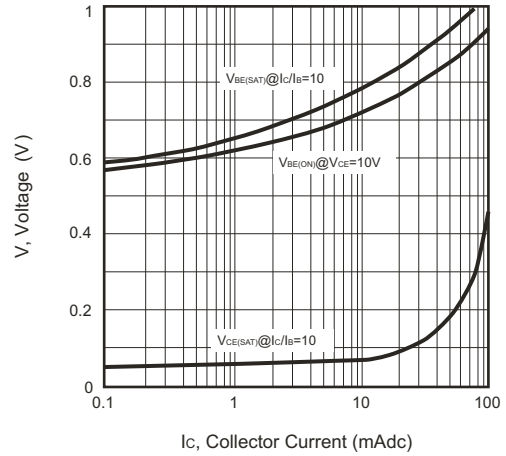

Fig.3 Collector Saturation Region

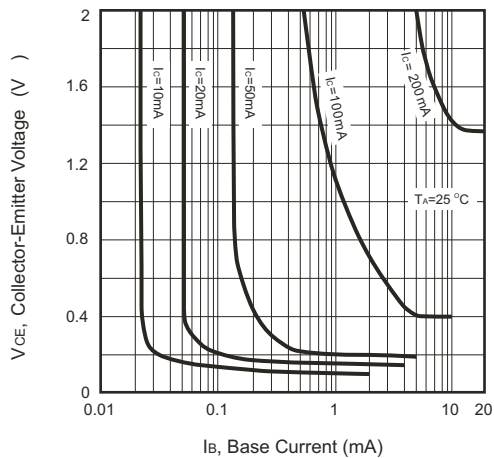

Fig.4 Base-Emitter Temperature Coefficient

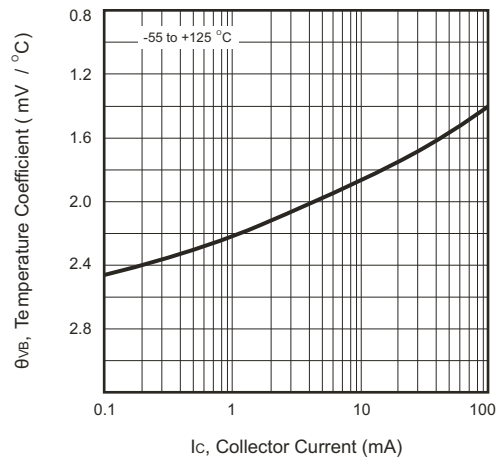

Fig.5 Capacitance

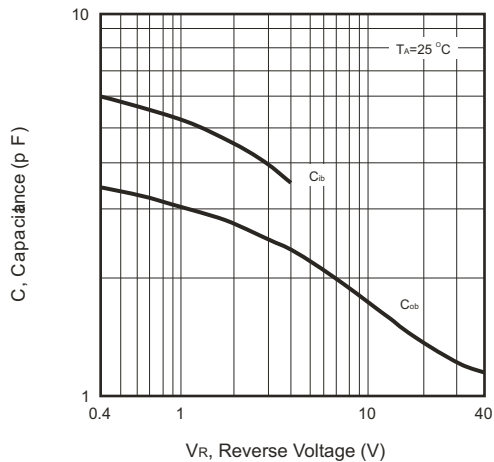
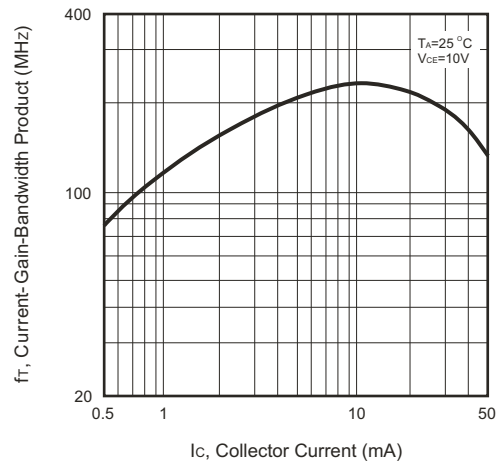
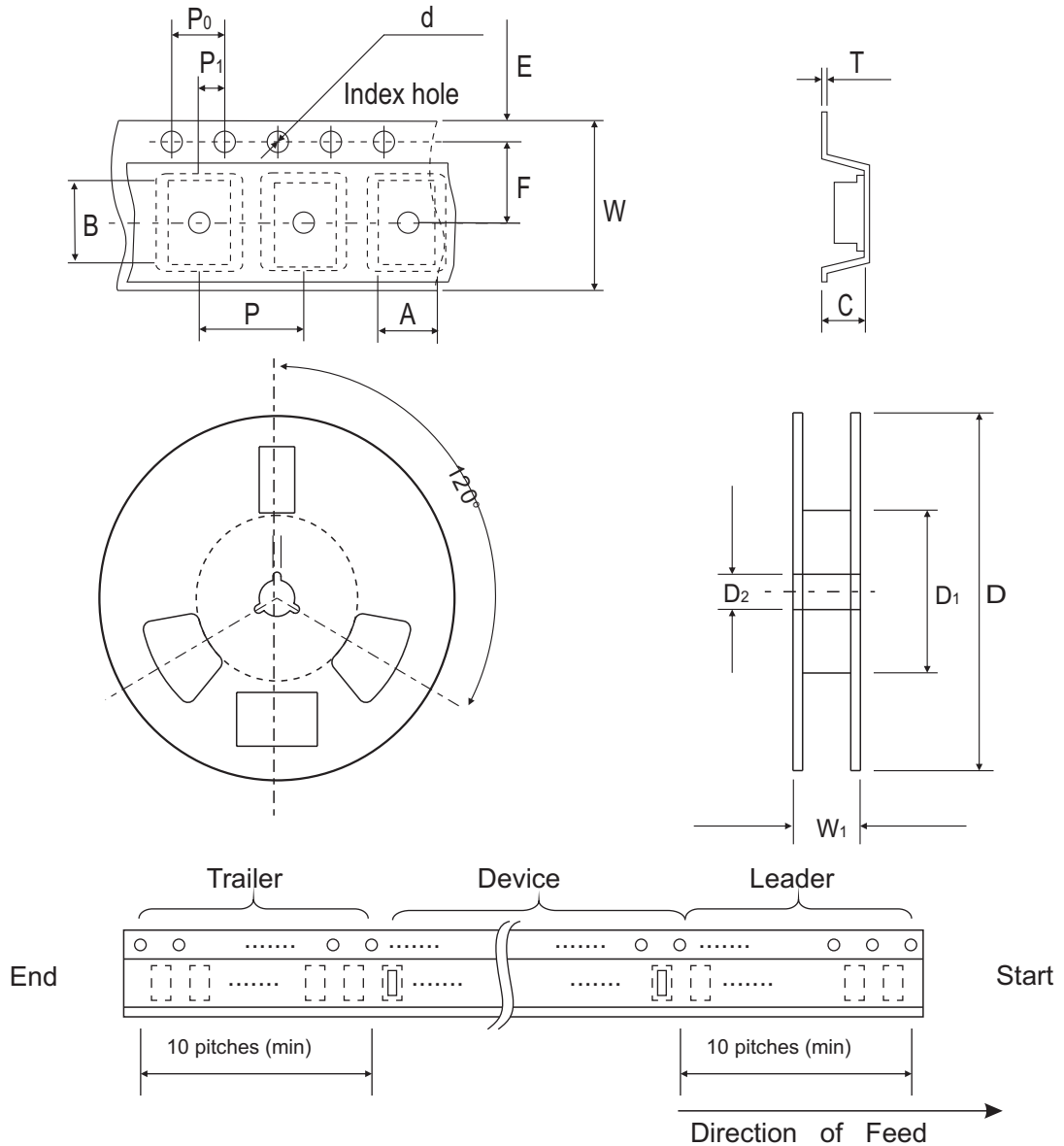

Fig.6 Current Gain Bandwidth Product



## Reel Taping Specification



SOT-323	SYMBOL	A	B	C	d	D	D1	D2
	(mm)	2.25 ± 0.10	2.55 ± 0.10	1.19 ± 0.10	1.55 ± 0.10	178 ± 1.00	54.40 ± 0.40	13.0 ± 0.20
	(inch)	0.089 ± 0.004	0.100 ± 0.004	0.047 ± 0.004	0.061 ± 0.004	7.008 ± 0.039	2.142 ± 0.016	0.512 ± 0.008

SOT-323	SYMBOL	E	F	P	P0	P1	W	W1
	(mm)	1.75 ± 0.10	3.50 ± 0.05	4.00 ± 0.10	4.00 ± 0.10	2.00 ± 0.10	8.00 + 0.30 / - 0.10	9.50 ± 1.00
	(inch)	0.069 ± 0.004	0.138 ± 0.002	0.158 ± 0.004	0.158 ± 0.004	0.079 ± 0.004	0.315 + 0.012 / - 0.004	0.374 ± 0.039