

BC846A-G Thru. BC848C-G (NPN)

RoHS Device



Features

- Power dissipation
PCM: 0.20W (@TA=25 °C)
- Collector current
ICM: 0.1A
- Collector-base voltage
VCBO: BC846=80V
BC847=50V
BC848=30V
- Operating and storage junction temperature range: TJ, TSTG= -65 to +150 °C

Mechanical data

- Case: SOT-23, molded plastic.
- Terminals: solderable per MIL-STD-750, method 2026.
- Approx. weight: 0.008 grams

Circuit diagram

- 1.BASE
- 2.EMITTER
- 3.COLLECTOR

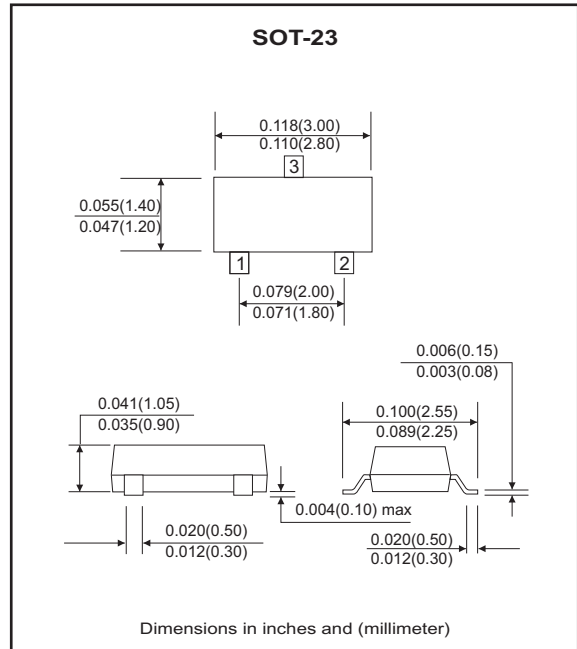
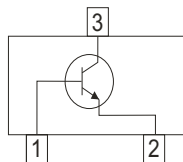

Maximum Ratings (at Ta=25 °C unless otherwise noted)

Parameter	Symbol	Value	UNIT
Collector-Base Voltage	BC846-G	80	V
	BC847-G	50	
	BC848-G	30	
Collector-Emitter Voltage	BC846-G	65	V
	BC847-G	45	
	BC848-G	30	
Emitter-Base Voltage	VEBO	6	V
Collector Current -Continuous	IC	0.1	A
Collector Power Dissipation	PC	200	mW
Junction Temperature	TJ	150	°C
Storage Temperature Range	TSTG	-65 to +150	°C

Electrical Characteristics

(BC846A-G Thru. BC848C-G, @T_A = 25 °C unless otherwise specified)

Parameter	Symbol	Test Conditions	MIN	TYP	MAX	UNIT
Collector-Base Breakdown Voltage	BC846-G BC847-G BC848-G	V _{CB0}	I _c = 10μA , I _E = 0	80 50 30		V
Collector-Emitter Breakdown Voltage	BC846-G BC847-G BC848-G	V _{CEO}	I _c = 10mA , I _B = 0	65 45 30		V
Emitter-Base Break Voltage		V _{EBO}	I _E = 10μA , I _C = 0	6		V
Collector Cut-off Current	BC846-G BC847-G BC848-G	I _{CBO}	V _{CB} = 70V , I _E = 0 V _{CB} = 50V , I _E = 0 V _{CB} = 30V , I _E = 0		0.1	μA
Collector Cut-off Current	BC846-G BC847-G BC848-G	I _{CEO}	V _{CB} = 60V , I _E = 0 V _{CB} = 45V , I _E = 0 V _{CB} = 30V , I _E = 0		0.1	μA
Emitter cut-off current		I _{EBO}	V _{EB} = 5V , I _C = 0		0.1	μA
DC Current Gain	BC846A,BC847A,BC848A BC846B,BC847B,BC848B BC847C,BC848C	h _{FE}	V _{CE} = 5V , I _C = 2mA	110 200 420	220 450 800	
Collector-Emitter Saturation Voltage		V _{CE(sat)}	I _C = 100mA , I _B = 5mA		0.5	V
Base-Emitter Saturation Voltage		V _{BE(sat)}	I _C = 100mA , I _B = 5mA		1.1	V
Transition Frequency		f _T	V _{CE} = 5V , I _C = 10mA f = 100MHz	100		MHz
Collector Output Capacitance		C _{ob}	V _{CB} = 10V , f = 1MHz		4.5	pF

Electrical Characteristic Curves (BC846A-G Thru. BC848C-G)

Fig.1- Static Characteristic

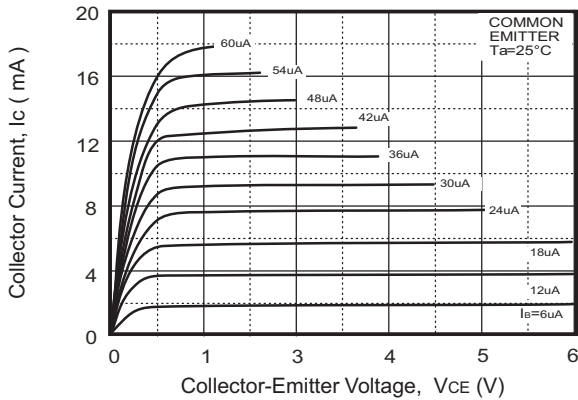

Fig.2- $h_{FE} - I_c$

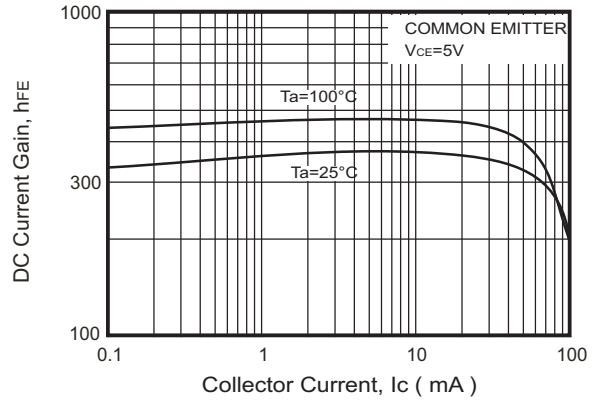

Fig.3- $V_{CEsat} - I_c$

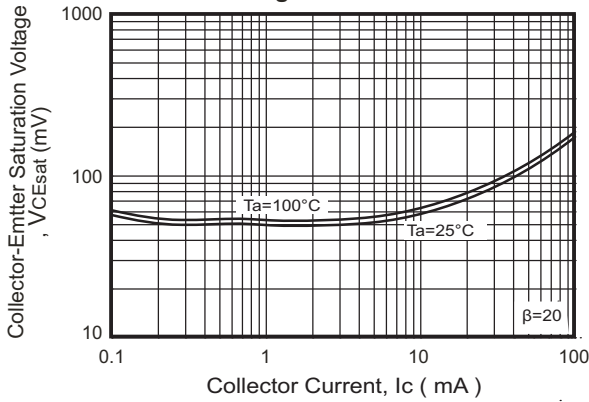

Fig.4- $V_{BEsat} - I_c$

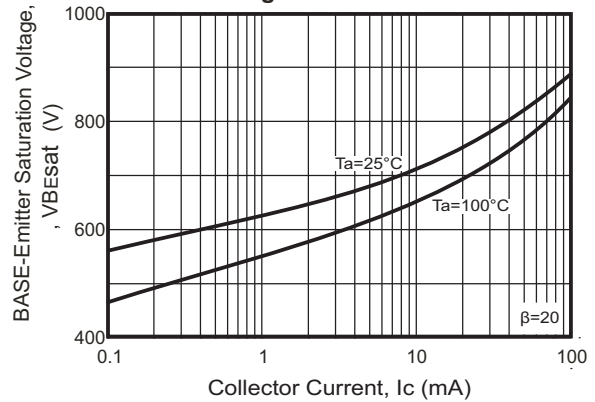

Fig.5- $I_c - V_{BE}$

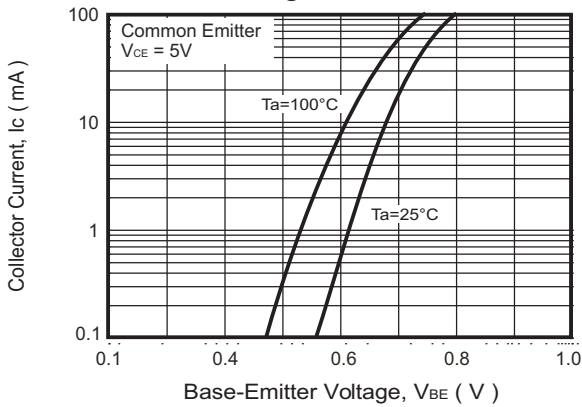

Fig.6- $C_{ob}/C_{ib} - V_{CB}/V_{EB}$

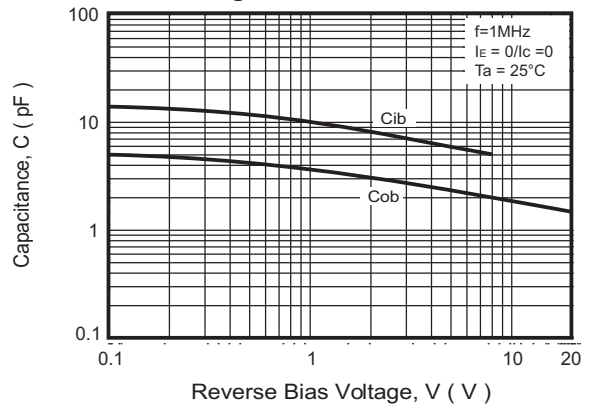

Fig.7- $f_r - I_c$

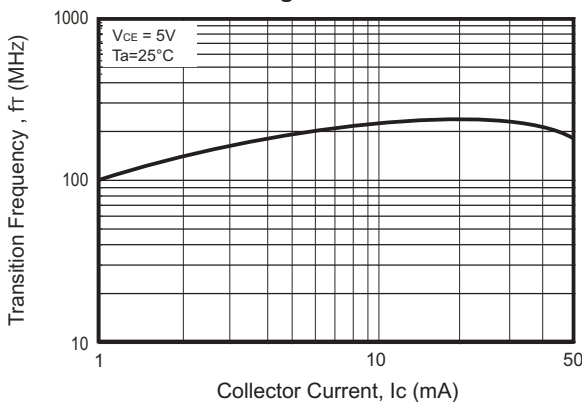
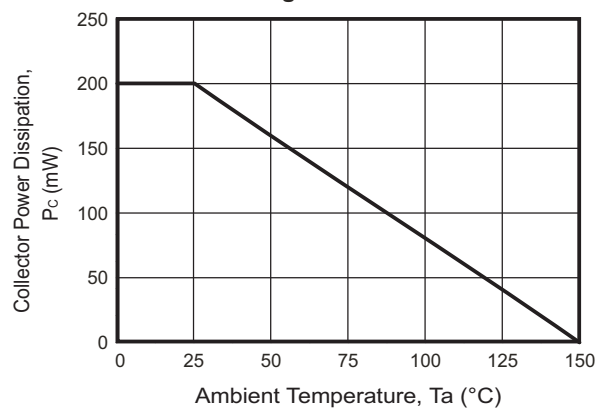
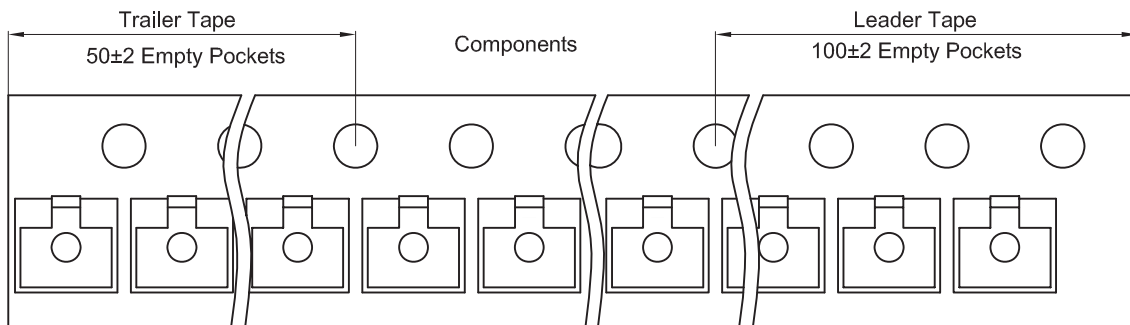
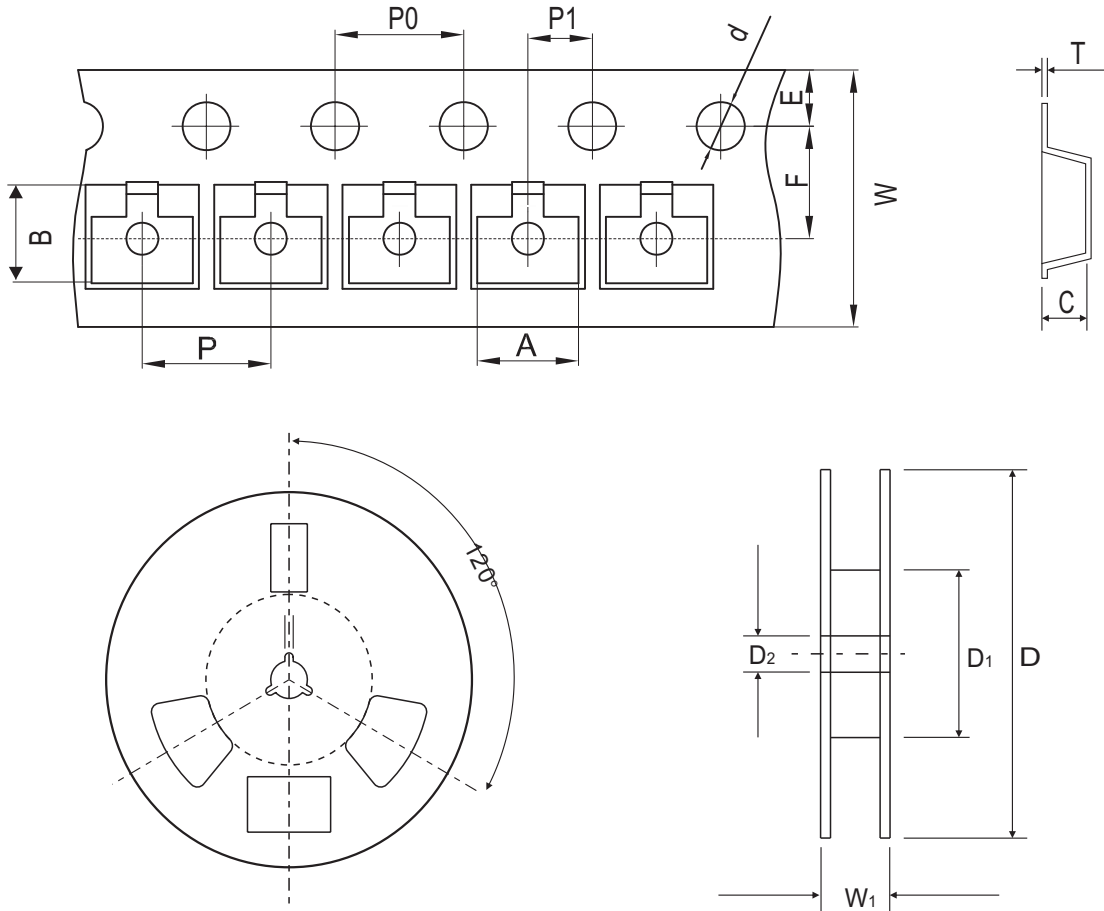

Fig.8- $P_c - T_a$



Reel Taping Specification



SOT-23	SYMBOL	A	B	C	d	D	D1	D2
	(mm)	3.15 ± 0.10	2.77 ± 0.10	1.22 ± 0.10	1.50 ± 0.10	178 ± 2.00	54.40 ± 1.00	13.00 ± 1.00
	(inch)	0.124 ± 0.004	0.109 ± 0.004	0.048 ± 0.004	0.059 ± 0.004	7.008 ± 0.079	2.142 ± 0.039	0.512 ± 0.039

SOT-23	SYMBOL	E	F	P	P0	P1	W	W1
	(mm)	1.75 ± 0.10	3.50 ± 0.10	4.00 ± 0.10	4.00 ± 0.10	2.00 ± 0.10	8.00 + 0.30 / - 0.10	12.30 ± 1.00
	(inch)	0.069 ± 0.004	0.138 ± 0.004	0.157 ± 0.004	0.157 ± 0.004	0.079 ± 0.004	0.315 + 0.012 / - 0.004	0.484 ± 0.039