

BC856AW-G Thru. BC858CW-G (PNP)

RoHS Device



Features

- Ideally suited for automatic insertion
- For Switching and AF Amplifier Applications
- Power dissipation
PCM: 0.15W (@TA=25°C)
- Collector current
ICM: -0.1A
- Collector-base voltage
VCBO: BC856W= -80V
BC857W= -50V
BC858W= -30V
- Operating and storage junction temperature range: TJ, TSTG= -65 to +150°C

Mechanical data

- Case: SOT-323, molded plastic.
- Terminals: solderable per MIL-STD-750, method 2026.

Circuit diagram

- 1.BASE
- 2.EMITTER
- 3.COLLECTOR

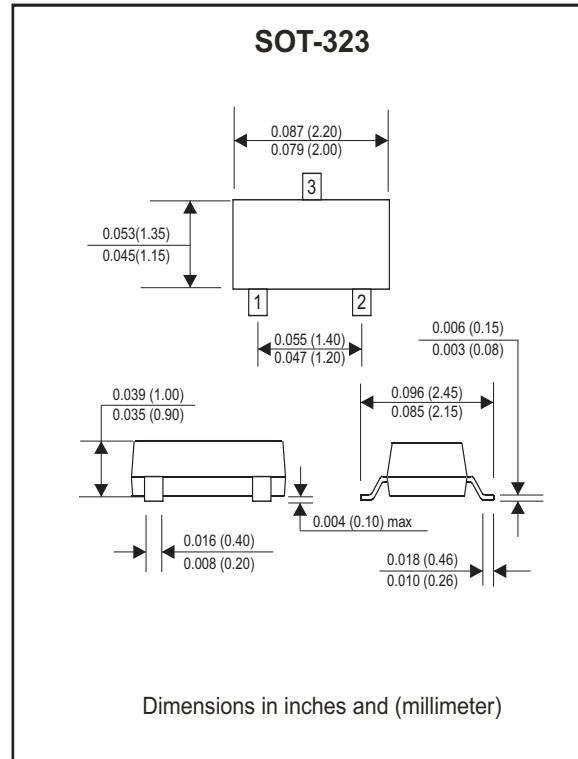
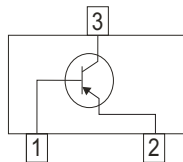

Maximum Ratings (at Ta=25°C unless otherwise noted)

Parameter	Symbol	Value	Units
Collector-Base Voltage BC856W-G BC857W-G BC858W-G	VCBO	-80 -50 -30	V
Collector-Emitter Voltage BC856W-G BC857W-G BC858W-G	VCEO	-65 -45 -30	V
Emitter-Base Voltage	VEBO	-5	V
Collector Current -Continuous	IC	-0.1	A
Collector Power Dissipation	PC	150	mW
Junction Temperature	TJ	150	°C
Storage Temperature Range	TSTG	-65 to +150	°C

Electrical Characteristics (T_A= 25 °C unless otherwise specified)

Parameter	Symbol	Test Conditions	MIN	MAX	Units
Collector-Base Breakdown Voltage BC856W-G BC857W-G BC858W-G	V _{CBO}	I _C = -10μA , I _E =0	-80 -50 -30		V
Collector-Emitter Breakdown Voltage BC856W-G BC857W-G BC858W-G	V _{CEO}	I _C = -10mA , I _B =0	-65 -45 -30		V
Emitter-Base Breakdown Voltage	V _{EBO}	I _E = -1μA , I _C =0	-5		V
Collector Cut-off Current	I _{CBO}	V _{CB} = -30V , I _E =0		-15	nA
DC Current Gain BC856AW,857AW,858AW BC856BW,857BW,858BW BC857CW,858CW	h _{FE}	V _{CE} = -5V , I _C = -2mA	125 220 420	250 475 800	
Collector-Emitter Saturation Voltage	V _{CE(sat)}	I _C = -100mA , I _B =-5mA		-0.65	V
Base-Emitter Saturation Voltage	V _{BE(sat)}	I _C = -100mA , I _B =-5mA		-1.1	V
Transition Frequency	f _r	V _{CE} =-5V , I _C =-10mA f=100MHz	100		MHz
Collector Capacitance	C _{ob}	V _{CB} = -10V , f=1MHz		4.5	pF

Electrical Characteristic Curves (BC856AW-G Thru. BC858CW-G)

Fig.1- DC current gain as a function fo collector current ;typical values.

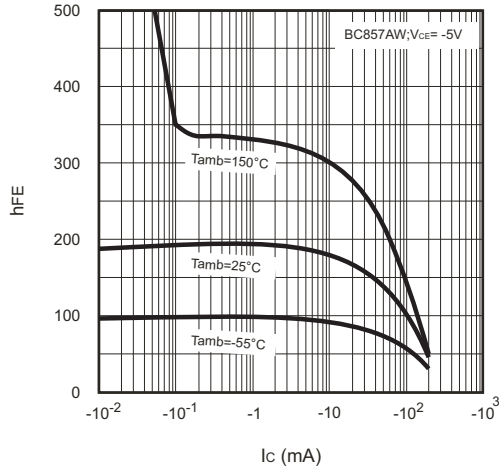

Fig.2- Base-Emitter Voltage as a function of collector current;typical values

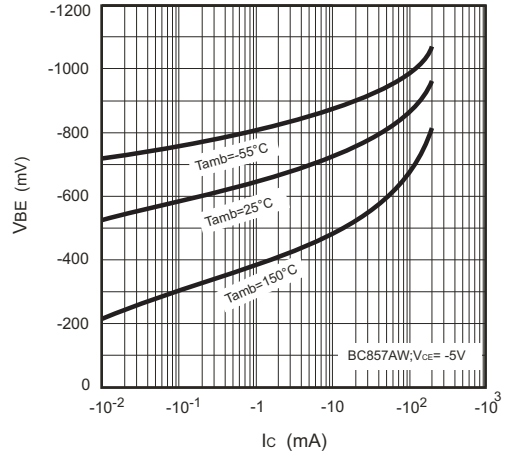

Fig.3- Collector-emitter saturation voltage as a function of collector current; typical values.

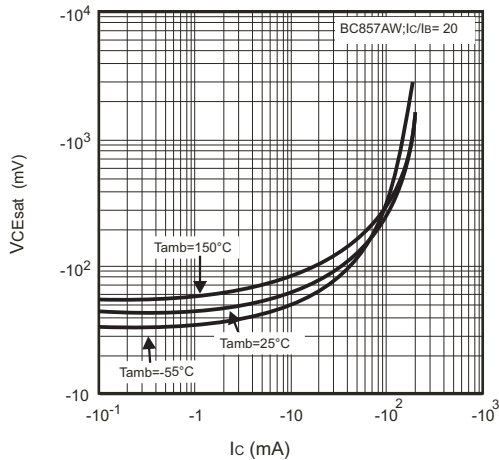

Fig.4- Base-emitter saturation voltage as a function of collector current; typical values

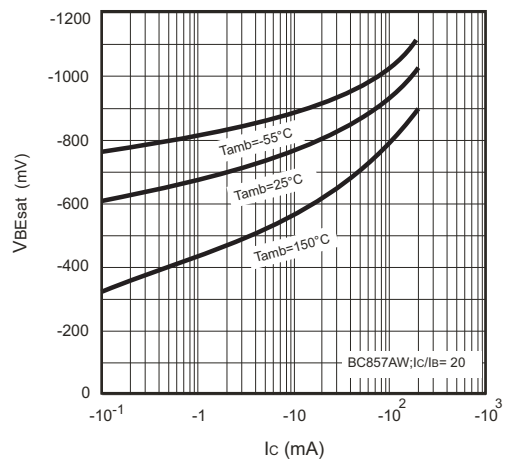

Fig.5- DC current gain as a function fo collector current ;typical values.

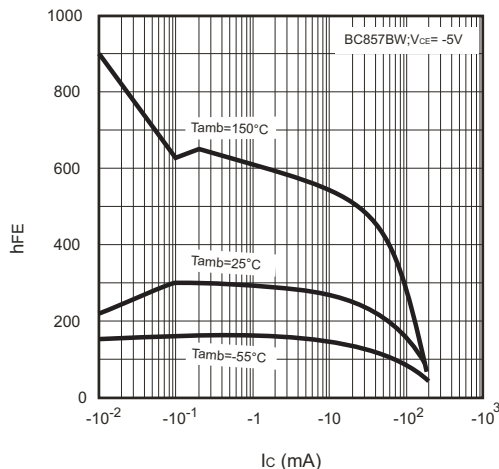
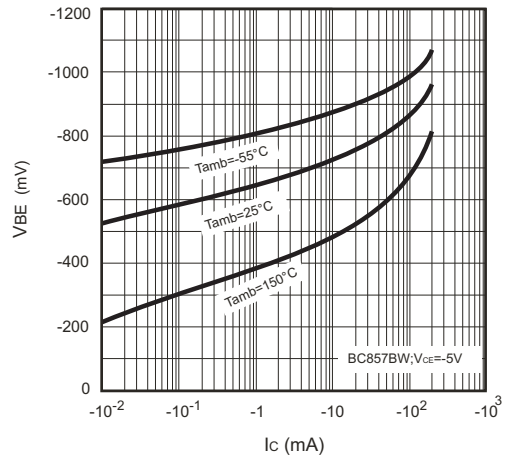

Fig.6- Base-emitter voltage as a function of collector current;typical values.



Electrical Characteristic Curves (BC856AW-G Thru. BC858CW-G)

Fig.7- Collector-emitter saturation voltage as a function of collector current typical values.

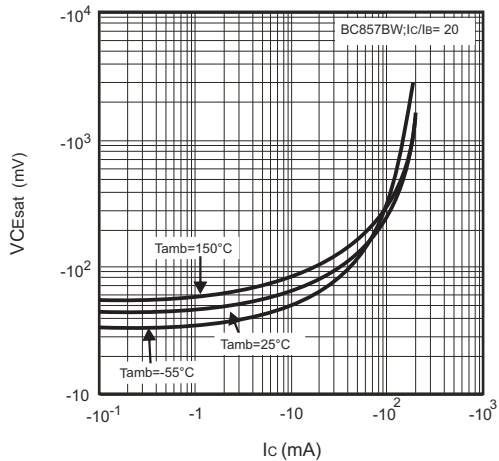

Fig.8- Base-Emitter Saturation Voltage as a function of collector current; typical values

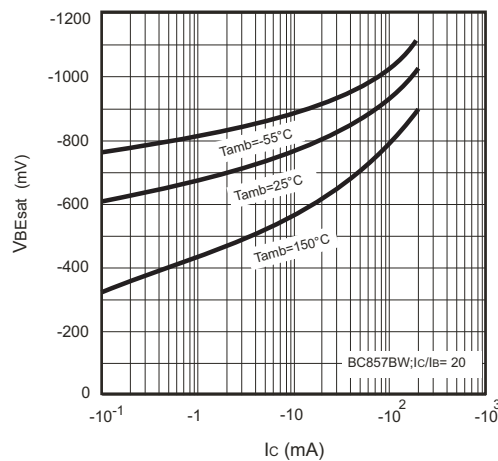

Fig.9- DC current gain as a function of collector current ; typical values.

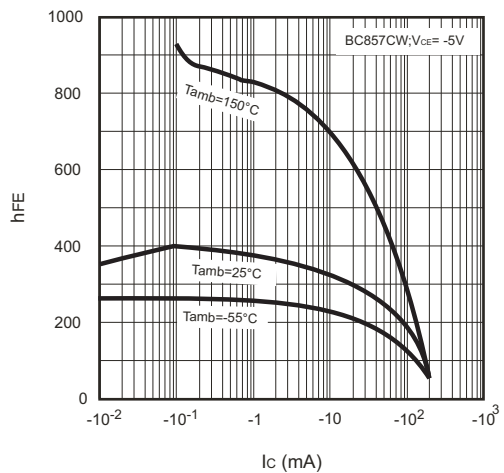

Fig.10- Base-Emitter Voltage as a function of collector current; typical values

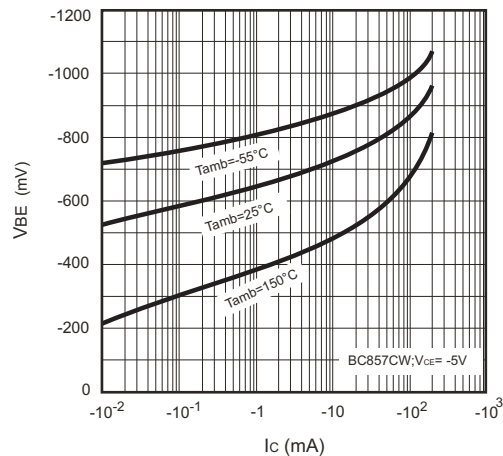

Fig.11- Collector-emitter saturation voltage as a function of collector current; typical values.

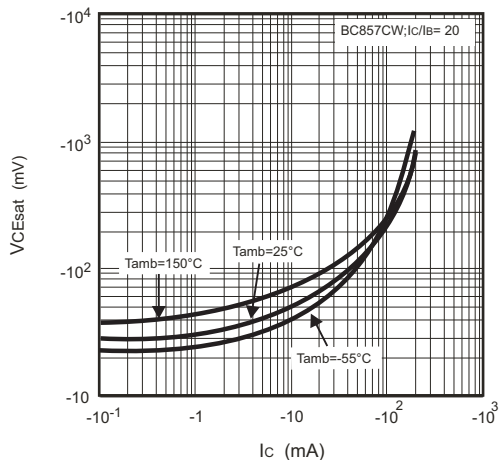
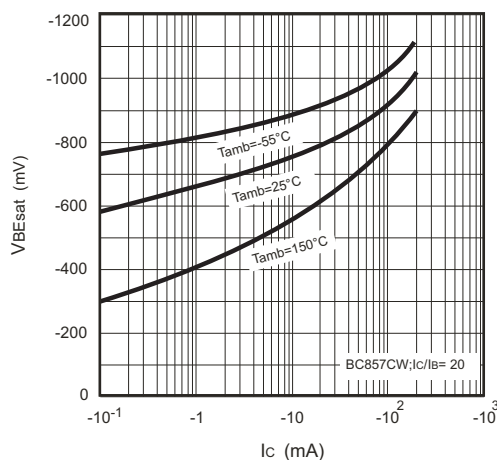
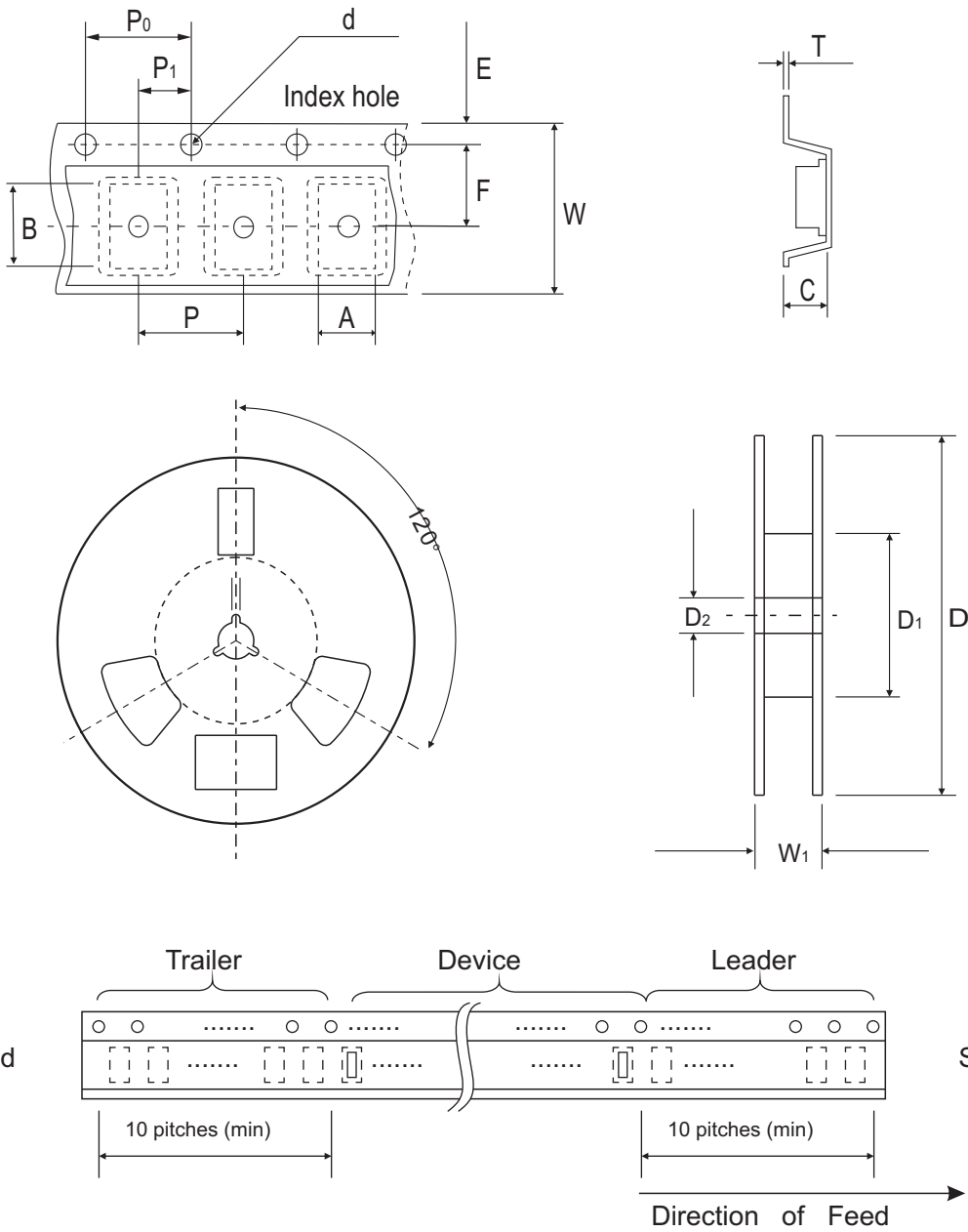

Fig.12- Base-Emitter Saturation Voltage as a function of collector current; typical values



Reel Taping Specification



SOT-323	SYMBOL	A	B	C	d	D	D1	D2
	(mm)	2.25 ± 0.10	2.55 ± 0.10	1.19 ± 0.10	1.55 ± 0.10	178 ± 1.00	54.40 ± 0.40	13.0 ± 0.20
	(inch)	0.089 ± 0.004	0.100 ± 0.004	0.047 ± 0.004	0.061 ± 0.004	7.008 ± 0.039	2.142 ± 0.016	0.512 ± 0.008

SOT-323	SYMBOL	E	F	P	P0	P1	W	W1
	(mm)	1.75 ± 0.10	3.50 ± 0.05	4.00 ± 0.10	4.00 ± 0.10	2.00 ± 0.10	8.00 + 0.30 / - 0.10	9.50 ± 1.00
	(inch)	0.069 ± 0.004	0.138 ± 0.002	0.158 ± 0.004	0.158 ± 0.004	0.079 ± 0.004	0.315 + 0.012 / - 0.004	0.374 ± 0.039