

FEATURES

- Ideally suited for automatic insertion
- For Switching and AF Amplifier Applications

SOT-23

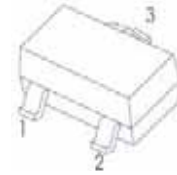

1. BASE
2. EMITTER
3. COLLECTOR

MAXIMUM RATINGS (T_a=25°C unless otherwise noted)

| Symbol | Parameter | Value | Unit |
|------------------------|---|----------|------|
| V_{CBO} | Collector-Base Voltage | | |
| | BC856 | -80 | V |
| | BC857 | -50 | |
| BC858 | -30 | | |
| V_{CEO} | Collector-Emitter Voltage | | |
| | BC856 | -65 | V |
| | BC857 | -45 | |
| BC858 | -30 | | |
| V_{EBO} | Emitter-Base Voltage | -5 | V |
| I_C | Collector Current –Continuous | -0.1 | A |
| P_C | Collector Power Dissipation | 200 | mW |
| R_{θJA} | Thermal Resistance From Junction To Ambient | 625 | °C/W |
| T_J | Junction Temperature | 150 | °C |
| T_{stg} | Storage Temperature | -65~+150 | °C |

ELECTRICAL CHARACTERISTICS (T_a=25°C unless otherwise specified)

| Parameter | Symbol | Test conditions | Min | Max | Unit |
|--------------------------------------|--------------------|---|--------------------------|------|---------|
| Collector-base breakdown voltage | BC856 | $I_C = -10\mu A, I_E = 0$ | -80 | | V |
| | BC857 | | -50 | | |
| | BC858 | | -30 | | |
| Collector-emitter breakdown voltage | BC856 | $I_C = -10mA, I_B = 0$ | -65 | | V |
| | BC857 | | -45 | | |
| | BC858 | | -30 | | |
| Emitter-base breakdown voltage | V_{EBO} | $I_E = -1\mu A, I_C = 0$ | -5 | | V |
| Collector cut-off current | BC856 | $V_{CB} = -70V, I_E = 0$ | | | μA |
| | BC857 | | $V_{CB} = -45V, I_E = 0$ | -0.1 | |
| | BC858 | | $V_{CB} = -25V, I_E = 0$ | | |
| Collector cut-off current | BC856 | $V_{CE} = -60V, I_B = 0$ | | | μA |
| | BC857 | | $V_{CE} = -40V, I_B = 0$ | -0.1 | |
| | BC858 | | $V_{CE} = -25V, I_B = 0$ | | |
| Emitter cut-off current | I_{EBO} | $V_{EB} = -5V, I_C = 0$ | | -0.1 | μA |
| DC current gain | BC856A, 857A, 858A | $V_{CE} = -5V, I_C = -2mA$ | 125 | 250 | |
| | BC856B, 857B, 858B | | 220 | 475 | |
| | BC857C, BC858C | | 420 | 800 | |
| Collector-emitter saturation voltage | $V_{CE(sat)}$ | $I_C = -100mA, I_B = -5mA$ | | -0.5 | V |
| Base-emitter saturation voltage | $V_{BE(sat)}$ | $I_C = -100mA, I_B = -5mA$ | | -1.1 | V |
| Transition frequency | f_T | $V_{CE} = -5V, I_C = -10mA$ $f = 100MHz$ | 100 | | MHz |
| Collector capacitance | C_{ob} | $V_{CB} = -10V, f = 1MHz$ | | 4.5 | pF |

RATING AND CHARACTERISTICS CURVES (BC856 THRU BC858)

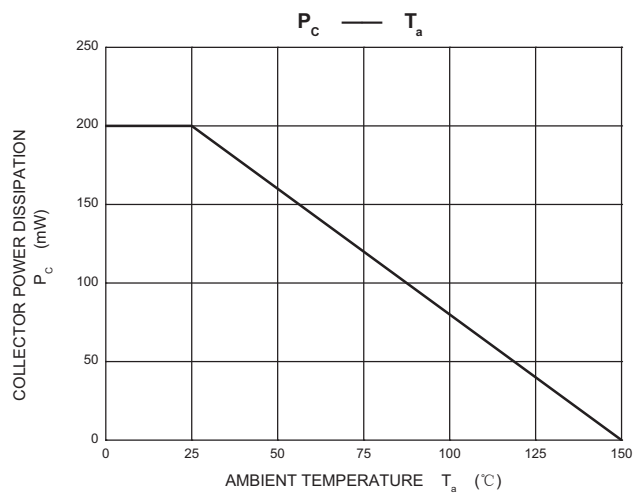
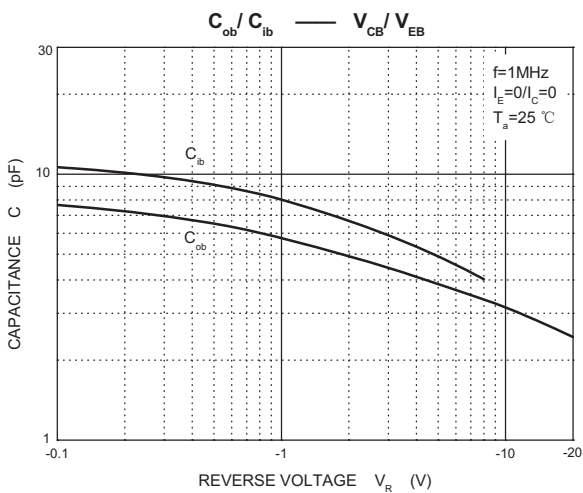

RATING AND CHARACTERISTICS CURVES (BC856 THRU BC858)

Static Characteristic

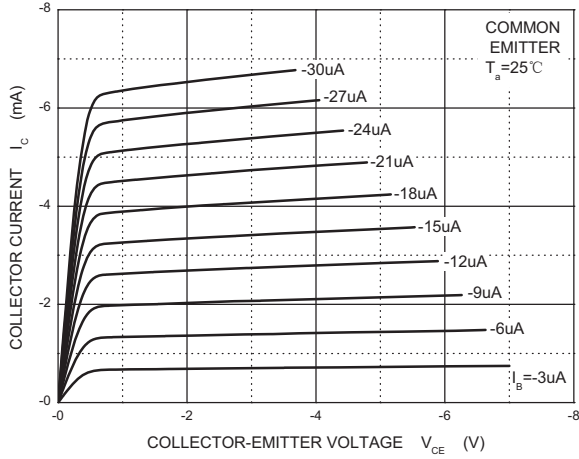

h_{FE} — I_c

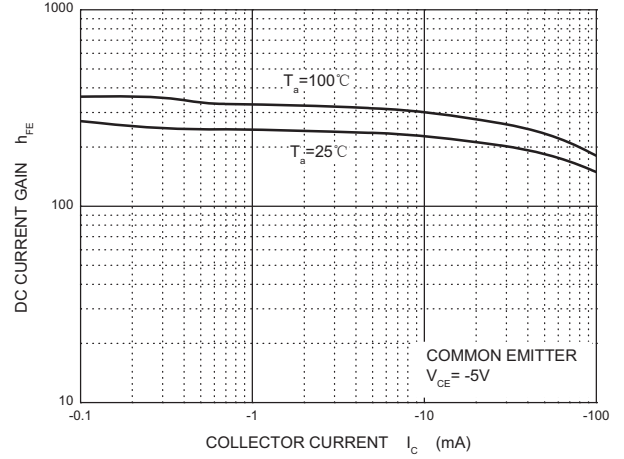

V_{CEsat} — I_c

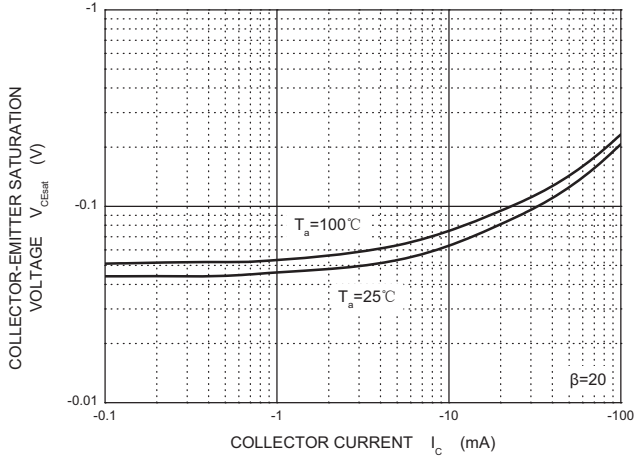

V_{BEsat} — I_c

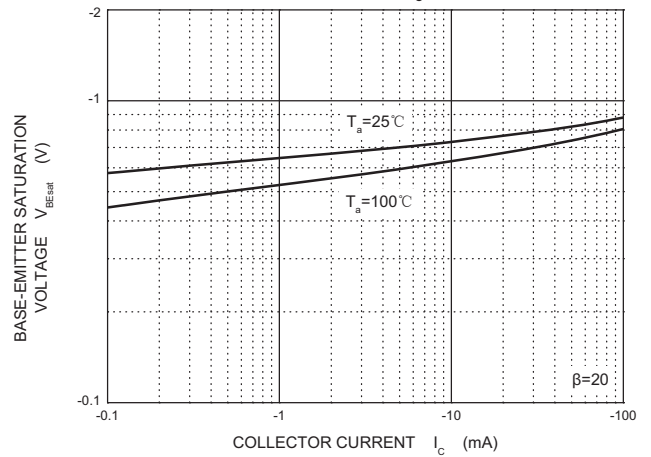

I_c — V_{BE}

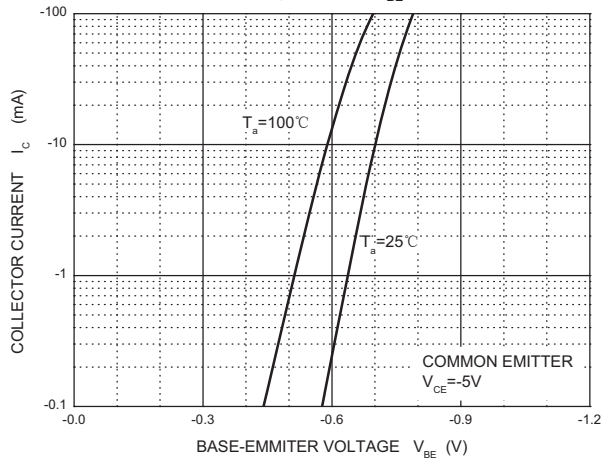

f_T — I_c

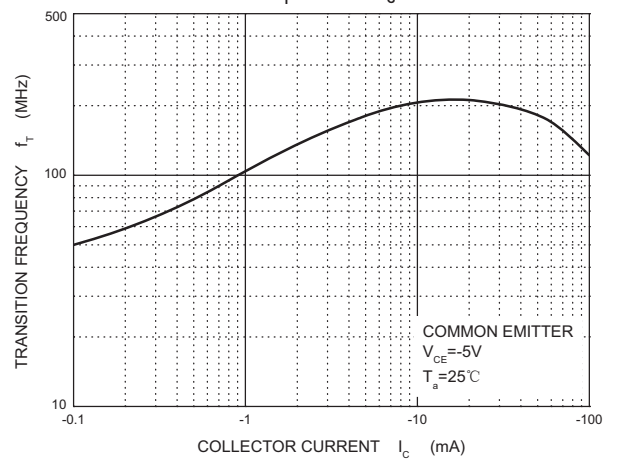

SOT-23 Package Outline Dimensions

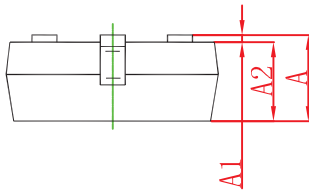
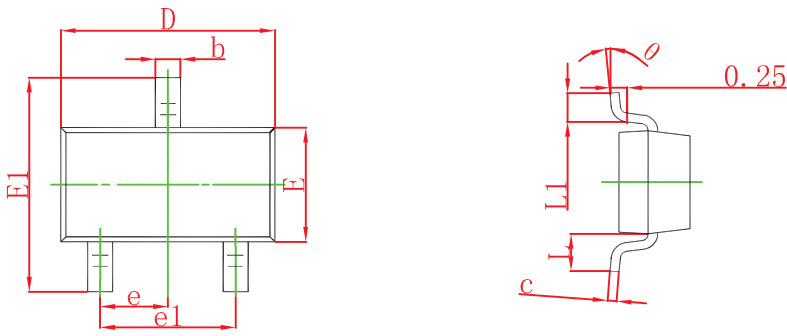

| Symbol | Dimensions In Millimeters | | Dimensions In Inches | |
|--------|---------------------------|-------|----------------------|-------|
| | Min | Max | Min | Max |
| A | 0.900 | 1.150 | 0.035 | 0.045 |
| A1 | 0.000 | 0.100 | 0.000 | 0.004 |
| A2 | 0.900 | 1.050 | 0.035 | 0.041 |
| b | 0.300 | 0.500 | 0.012 | 0.020 |
| c | 0.080 | 0.150 | 0.003 | 0.006 |
| D | 2.800 | 3.000 | 0.110 | 0.118 |
| E | 1.200 | 1.400 | 0.047 | 0.055 |
| E1 | 2.250 | 2.550 | 0.089 | 0.100 |
| e | 0.950 TYP | | 0.037 TYP | |
| e1 | 1.800 | 2.000 | 0.071 | 0.079 |
| L | 0.550 REF | | 0.022 REF | |
| L1 | 0.300 | 0.500 | 0.012 | 0.020 |
| theta | 0° | 8° | 0° | 8° |

SOT-23 Suggested Pad Layout

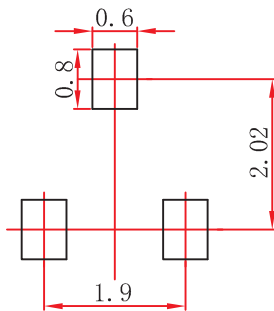

Note:

1. Controlling dimension: in millimeters.
2. General tolerance: $\pm 0.05\text{mm}$.
3. The pad layout is for reference purposes only.

DEVICE MARKING

BC856A=3A; BC856B=3B;
 BC857A=3E; BC857B=3F; BC857C=3G;
 BC858A=3J; BC858B=3K; BC858C=3L

SOT-23 Tape and Reel

SOT-23 Embossed Carrier Tape

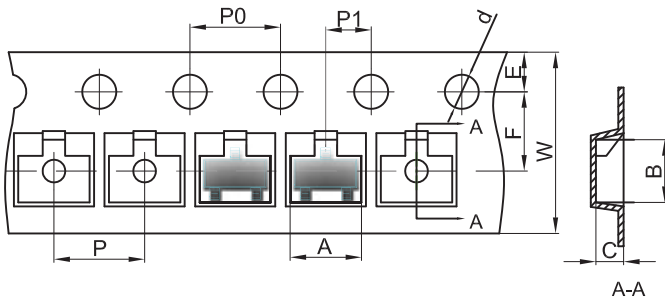

Packaging Description:

SOT-23 parts are shipped in tape. The carrier tape is made from a dissipative (carbon filled) polycarbonate resin. The cover tape is a multilayer film (Heat Activated Adhesive in nature) primarily composed of polyester film, adhesive layer, sealant, and anti-static sprayed agent. These reeled parts in standard option are shipped with 3,000 units per 7" or 17.8cm diameter reel. The reels are clear in color and is made of polystyrene plastic (anti-static coated).

Dimensions are in millimeter

| Pkg type | A | B | C | d | E | F | P0 | P | P1 | W |
|----------|------|------|------|-------|------|------|------|------|------|------|
| SOT-23 | 3.15 | 2.77 | 1.22 | Ø1.50 | 1.75 | 3.50 | 4.00 | 4.00 | 2.00 | 8.00 |

SOT-23 Tape Leader and Trailer

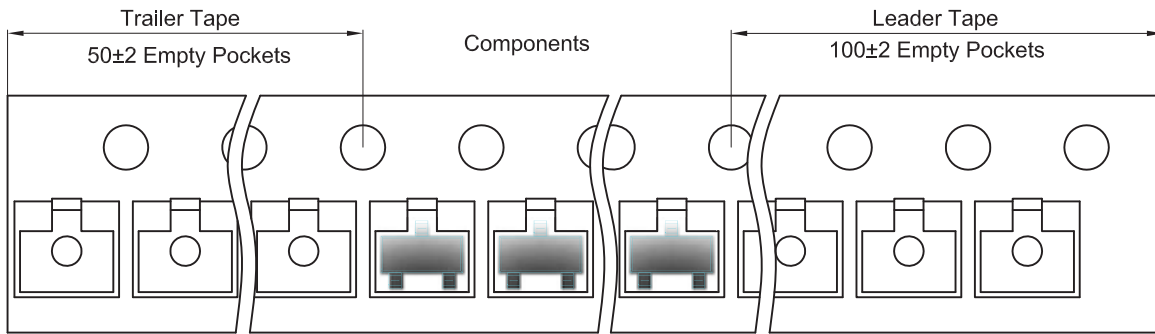

SOT-23 Reel

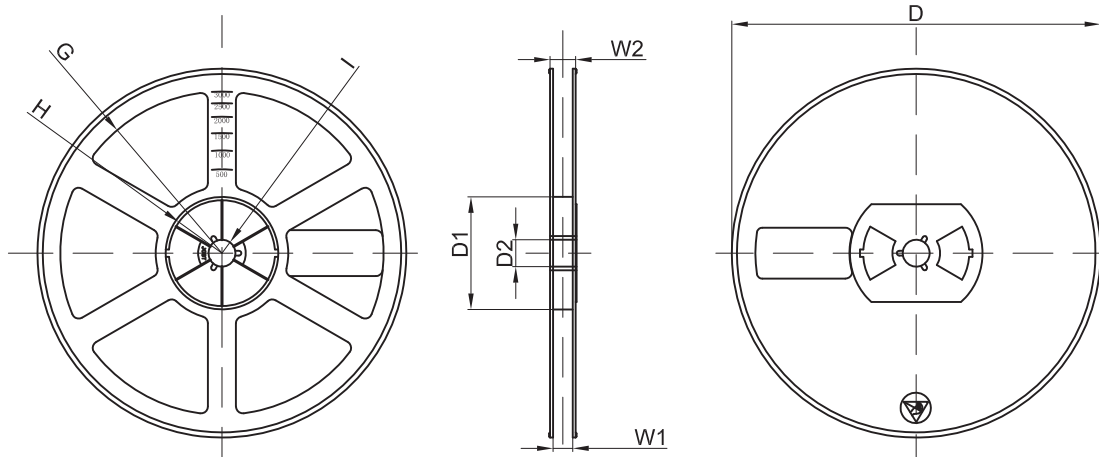

Dimensions are in millimeter

| Reel Option | D | D1 | D2 | G | H | I | W1 | W2 |
|-------------|---------|-------|-------|--------|--------|-------|------|-------|
| 7" Dia | Ø178.00 | 54.40 | 13.00 | R78.00 | R25.60 | R6.50 | 9.50 | 12.30 |

| REEL | Reel Size | Box | Box Size(mm) | Carton | Carton Size(mm) | G.W.(kg) |
|----------|-----------|------------|--------------|-------------|-----------------|----------|
| 3000 pcs | 7 inch | 45,000 pcs | 203×203×195 | 180,000 pcs | 438×438×220 | |