

BC856-HF Thru. BC858-HF Series (PNP)

RoHS Device
Halogen Free



Features

- Ideally suited for automatic insertion
- Power dissipation
PCM: 0.25W (@TA=25°C)
- Low current.(max. 100mA)
- Collector-base voltage
VCBO: BC856 = -80V
BC857 = -50V
BC858 = -30V
- Operating and storage junction temperature range: TJ, TSTG= -65 to +150°C

Mechanical data

- Case: SOT-23, molded plastic.
- Terminals: Solderable per MIL-STD-750, method 2026.

Circuit diagram

- 1.BASE
- 2.EMITTER
- 3.COLLECTOR

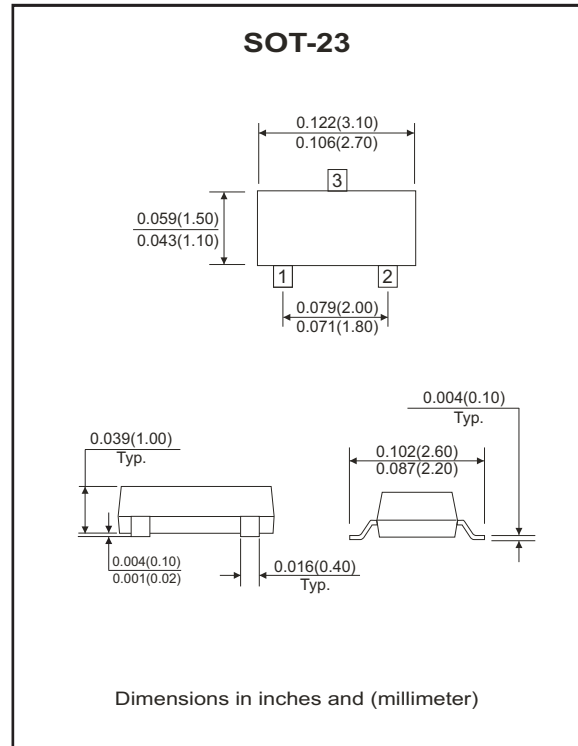
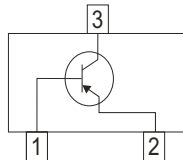

Maximum Ratings (at Ta=25°C unless otherwise noted)

Parameter	Symbol	Value	Unit	
Collector-Base voltage	BC856 BC857 BC858	VCBO	-80 -50 -30	V
Collector-Emitter voltage	BC856 BC857 BC858	VCEO	-65 -45 -30	V
Emitter-Base voltage		VEBO	-5	V
Collector current-continuous		IC	-0.1	A
Collector dissipation		PC	250	mW
Junction temperature range		TJ	-65 to +150	°C
Storage temperature range		TSTG	-65 to +150	°C

Electrical Characteristics (T_A= 25°C unless otherwise specified)

Parameter	Symbol	Test Conditions	MIN	TYP	MAX	Unit
Collector-Base breakdown voltage	BC856 BC857 BC858 V _{(BR)CBO}	I _C = -10μA , I _E =0	-80 -50 -30			V
Collector-Emitter breakdown voltage	BC856 BC857 BC858 V _{(BR)CEO}	I _C = -10mA , I _B =0	-65 -45 -30			V
Emitter-Base breakdown voltage	V _{(BR)EBO}	I _E = -1μA , I _C =0	-5			V
Collector cut-off current	I _{CBO}	V _{CB} = -30V , I _E =0		-1	-15	nA
Emitter cut-off current	I _{EBO}	V _{EB} = -5V , I _C =0			-0.1	μA
DC current gain	BC856A ,857A ,858A BC856B ,857B ,858B BC857C ,858C h _{FE}	V _{CE} = -5V , I _C = -2.2mA	125 220 420		250 475 800	
Collector-Emitter saturation voltage	V _{CE(sat)}	I _C = -100mA , I _B =-5mA I _C = -10mA , I _B =-0.5mA			-0.65 -0.3	V
Base-Emitter saturation voltage	V _{BE(sat)}	I _C = -10mA , I _B =-0.5mA I _C = -100mA , I _B =-5mA		-0.7 -0.85		V
Base-Emitter voltage	V _{BE(on)}	I _C = -2mA , V _{CE} =-5V I _C = -10mA , V _{CE} =-5V	-0.6	-0.65	-0.75 -0.82	V
Collector capacitance	C _C	V _{CB} = -10V , I _E =I _e =0 f=1MHz		4.5		pF
Transition frequency	F	I _C =-200uA, V _{CE} =-5V R _S =2kΩ, f=1kHz, B=200Hz		2	10	dB
Transition frequency	f _T	V _{CE} =-5V, I _C =-10mA f=100MHz	100			MHz

Electrical Characteristic Curves (BC856-HF Thru. BC858-HF Series)

Fig.1 - DC current gain as a function fo collector current; typical values.

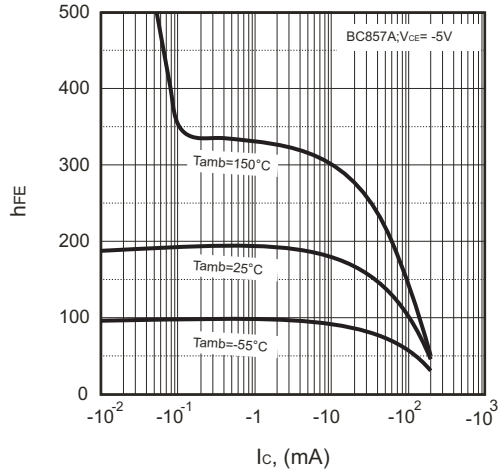

Fig.2 - Base-Emitter voltage as a function of collector current; typical values

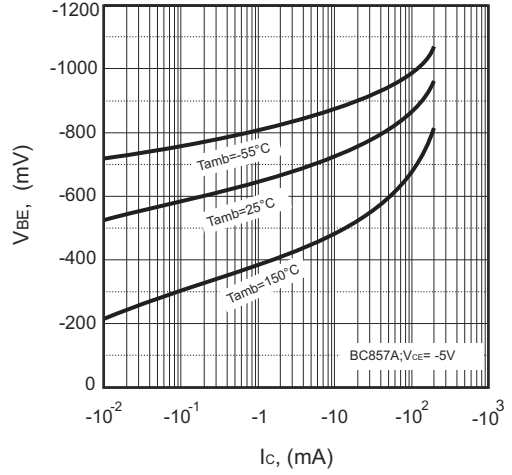

Fig.3 - Collector-Emitter saturation voltage as a function of collector current; typical values.

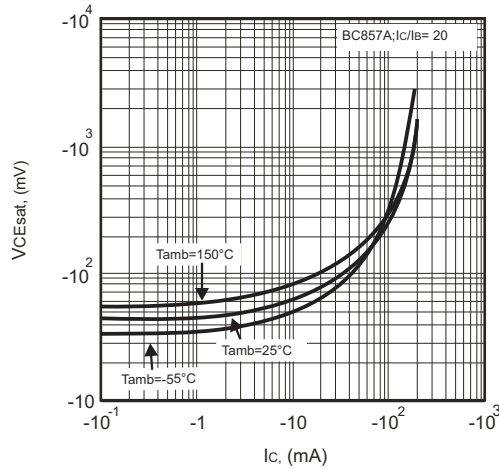

Fig.4 - Base-Emitter saturation voltage as a function of collector current; typical values

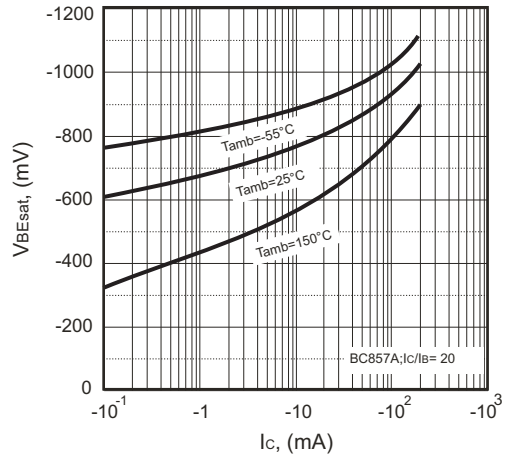

Fig.5 - DC current gain as a function fo collector current; typical values.

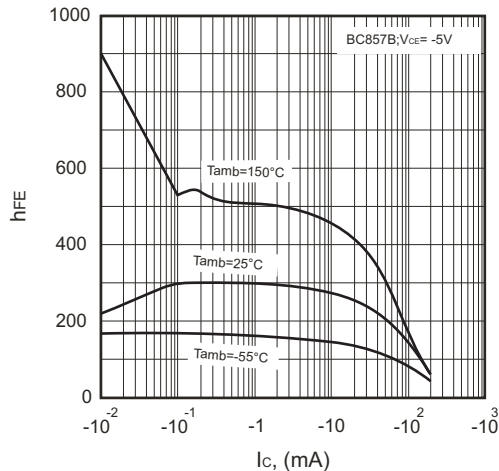
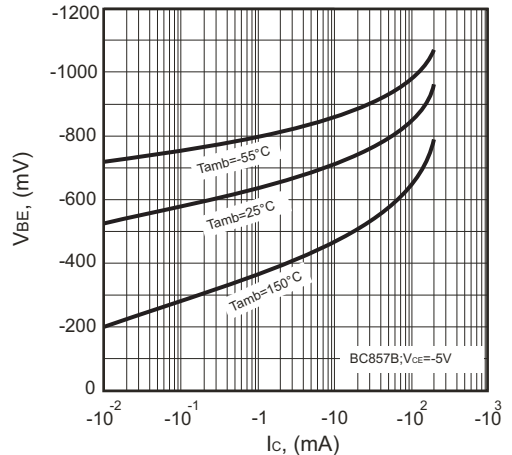

Fig. 6 - Base-Emitter voltage as a function of collector current; typical values.



Electrical Characteristic Curves (BC856-HF Thru. BC858-HF Series)

Fig.7 - Collector-Emitter saturation voltage as a function of collector current typical values.

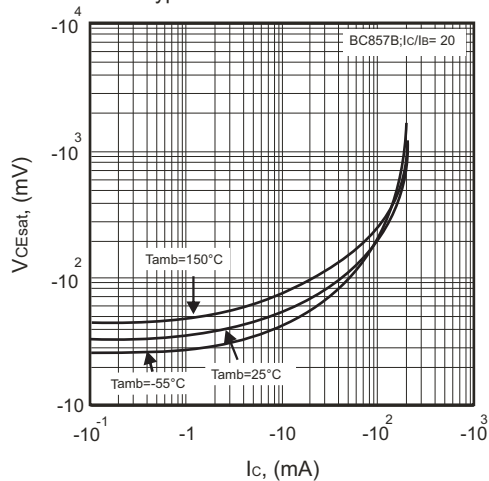

Fig.8 - Base-Emitter saturation voltage as a function of collector current; typical values

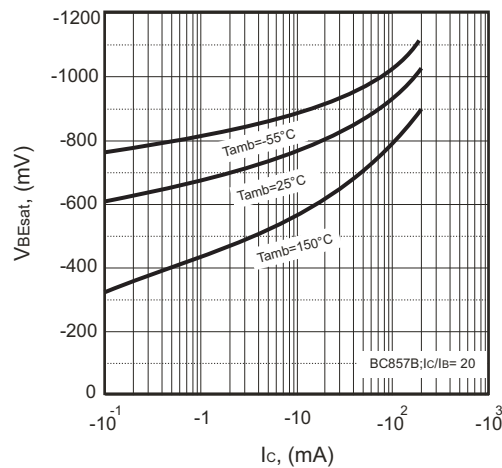

Fig.9 - DC current gain as a function fo collector current; typical values.

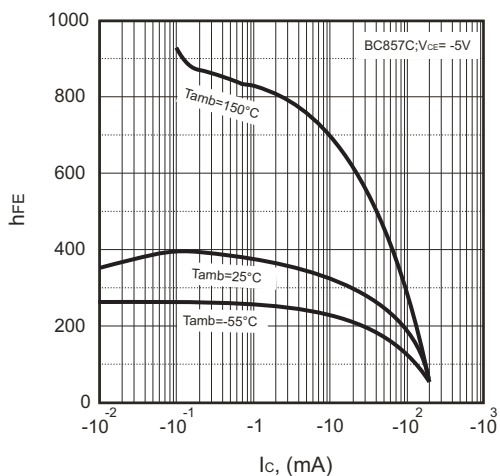

Fig.10 - Base-Emitter voltage as a function of collector current; typical values

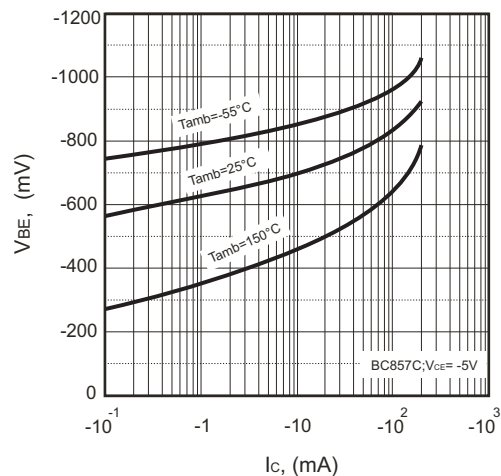

Fig.11 - Collector-Emitter saturation voltage as a function of collector current; typical values.

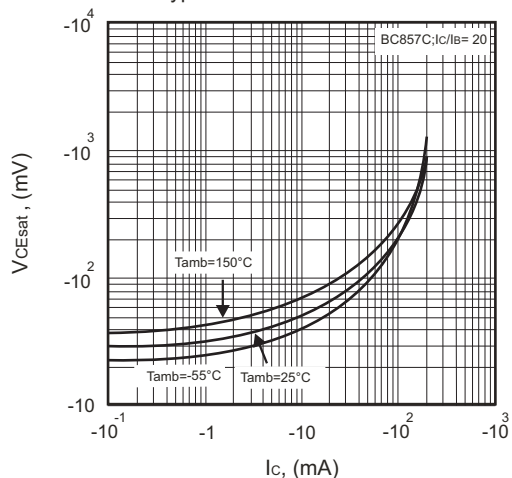
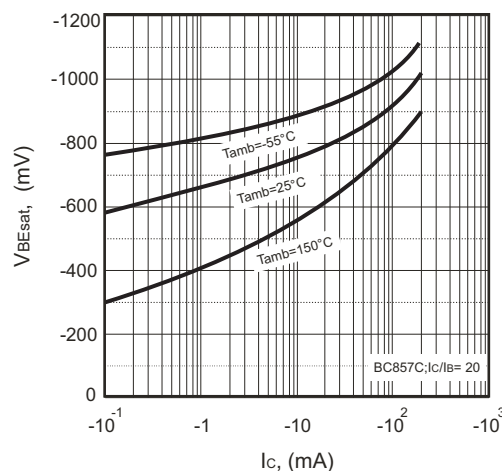
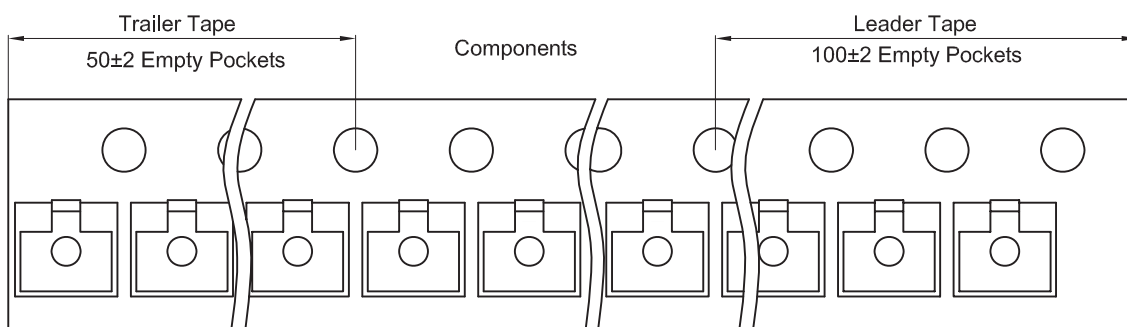
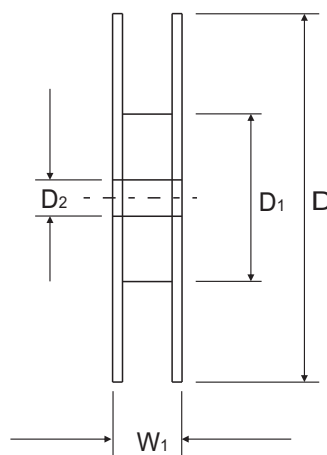
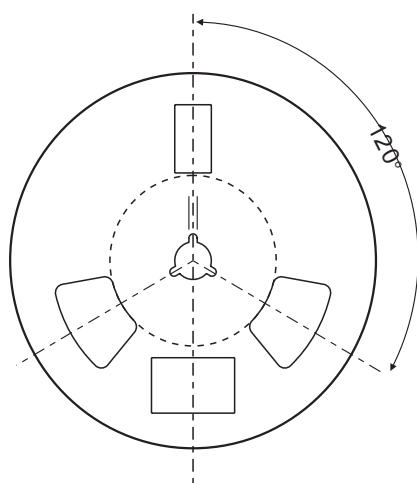
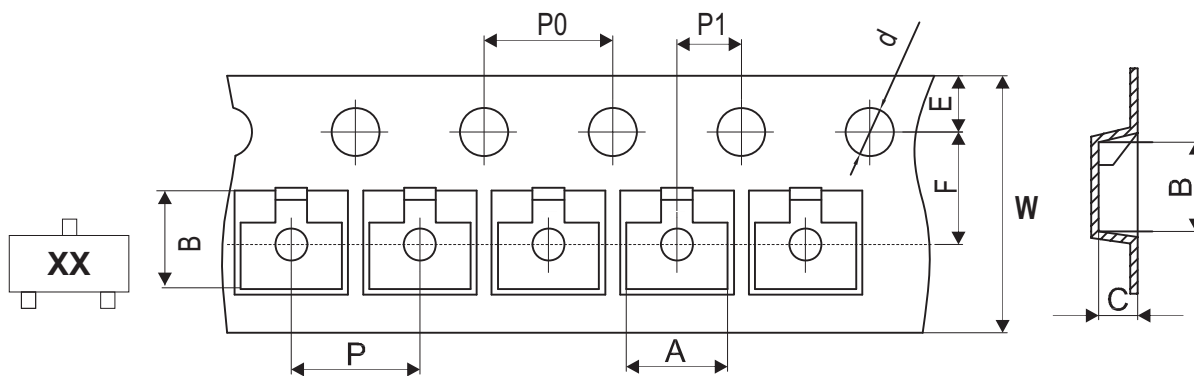

Fig.12 - Base-Emitter saturation voltage as a function of collector current; typical values



Reel Taping Specification



SOT-23	SYMBOL	A	B	C	d	D	D1	D2
	(mm)	3.15 ± 0.10	2.77 ± 0.10	1.22 ± 0.10	1.50 ± 0.10	178.00 ± 1.00	54.40 ± 0.50	13.00 ± 0.50
	(inch)	0.124 ± 0.004	0.109 ± 0.004	0.048 ± 0.004	0.059 ± 0.004	7.008 ± 0.039	2.142 ± 0.020	0.512 ± 0.020

SOT-23	SYMBOL	E	F	P	P0	P1	W	W1
	(mm)	1.75 ± 0.10	3.50 ± 0.05	4.00 ± 0.10	4.00 ± 0.10	2.00 ± 0.05	8.00 + 0.30 / - 0.10	12.50 ± 1.00
	(inch)	0.069 ± 0.004	0.138 ± 0.002	0.157 ± 0.004	0.157 ± 0.004	0.079 ± 0.002	0.315 + 0.012 / - 0.004	0.492 ± 0.039