

200mW, PNP Small Signal Transistor

FEATURES

- Low power loss, high efficiency
- Ideal for automated placement
- High surge current capability
- Moisture sensitivity level: level 1, per J-STD-020
- RoHS Compliant
- Halogen-free according to IEC 61249-2-21

APPLICATIONS

- Switching mode power supply (SMPS)
- Adapters
- Lighting application
- On-board DC/DC converter

MECHANICAL DATA

- Case: SOT-23
- Molding compound meets UL 94 V-0 flammability rating
- Terminal: Matte tin plated leads, solderable per J-STD-002
- Meet JESD 201 class 1A whisker test
- Weight: 0.008 g (approximately)

KEY PARAMETERS		
PARAMETER	VALUE	UNIT
V_{CBO}	-80	V
V_{CEO}	-65	V
V_{EBO}	-5	V
I_C	-0.1	A
h_{FE}	250-800	
Package	SOT-23	
Configuration	Single die	

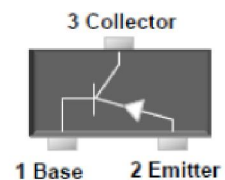

ABSOLUTE MAXIMUM RATINGS ($T_A = 25^\circ\text{C}$ unless otherwise noted)				
PARAMETER		SYMBOL	VALUE	UNIT
Marking code on the device	BC856A		3A	
	BC856B		3B	
	BC857A		3E	
	BC857B		3F	
	BC857C		3G	
	BC858A		3J	
	BC858B		3K	
	BC858C		3L	
Power dissipation		P_D	200	mW

ABSOLUTE MAXIMUM RATINGS ($T_A = 25^\circ\text{C}$ unless otherwise noted)				
PARAMETER		SYMBOL	VALUE	UNIT
Collector-base voltage	BC856	V_{CBO}	-80	V
	BC857		-50	
	BC858		-30	
Collector-emitter voltage	BC856	V_{CEO}	-65	V
	BC857		-45	
	BC858		-30	
Emitter-base voltage		V_{EBO}	-5	V
Collector current		I_C	-0.1	A
Junction temperature		T_J	-55 to +150	$^\circ\text{C}$
Storage temperature		T_{STG}	-55 to +150	$^\circ\text{C}$

ELECTRICAL SPECIFICATIONS ($T_A = 25^\circ\text{C}$ unless otherwise noted)						
PARAMETER	CONDITIONS		SYMBOL	MIN	MAX	UNIT
Collector cutoff current	$V_{CB} = -70\text{ V}, I_E = 0$	BC856	I_{CBO}	-	-100	nA
	$V_{CB} = -45\text{ V}, I_E = 0$	BC857		-	-100	
	$V_{CB} = -25\text{ V}, I_E = 0$	BC858		-	-100	
Emitter cutoff current	$V_{EB} = -5\text{ V}, I_C = 0$		I_{EBO}	-	-0.1	μA
Collector-base voltage	$I_C = -10\ \mu\text{A}, I_E = 0$	BC856	V_{CBO}	-80	-	V
		BC857		-50	-	
		BC858		-30	-	
Collector-emitter voltage	$I_C = -10\text{ mA}, I_B = 0$	BC856	V_{CEO}	-65	-	V
		BC857		-45	-	
		BC858		-30	-	
Emitter-base voltage	$I_E = -1\ \mu\text{A}, I_C = 0$		V_{EBO}	-5	-	V
DC current gain	$V_{CE} = -5\text{ V}, I_C = -2\text{ mA}$	BC856A/BC857A/BC858A	h_{FE}	125	250	
		BC856B/BC857B/BC858B		220	475	
		BC857C/BC858C		420	800	
Collector-emitter saturation voltage	$I_C = -100\text{ mA}, I_B = -5\text{ mA}$		$V_{CE(sat)}$	-	-0.65	V
Base-emitter saturation voltage	$I_C = -100\text{ mA}, I_B = -5\text{ mA}$		$V_{BE(sat)}$	-	-1.10	V
Transition frequency	$V_{CE} = -5\text{ V}, I_C = -10\text{ mA}, f = 100\text{ MHz}$		f_T	100	-	MHz

ORDERING INFORMATION		
ORDERING CODE (Note1, 2)	PACKAGE	PACKING
BC85XX RF	SOT-23	3K / 7" Reel
BC85XX RFG	SOT-23	3K / 7" Reel

Note:

1. "xx" is device code "6A" to "8C"
2. "G" means green compound (halogen free)

CHARACTERISTICS CURVES

($T_A = 25^\circ\text{C}$ unless otherwise noted)

Fig.1 Static Characteristic

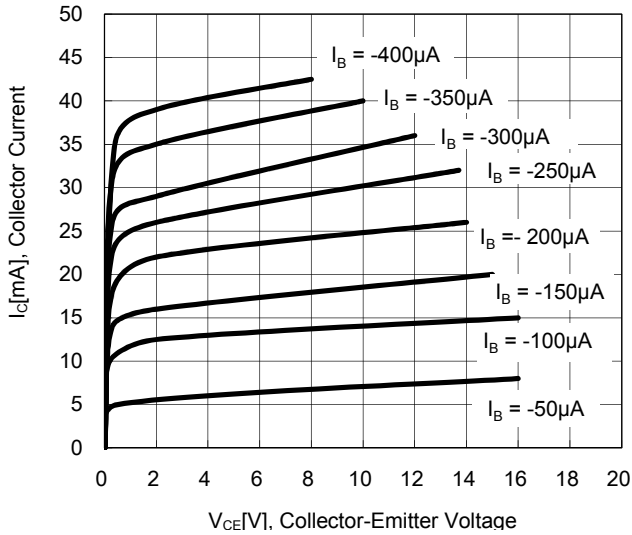

Fig. 2 DC Current Gain

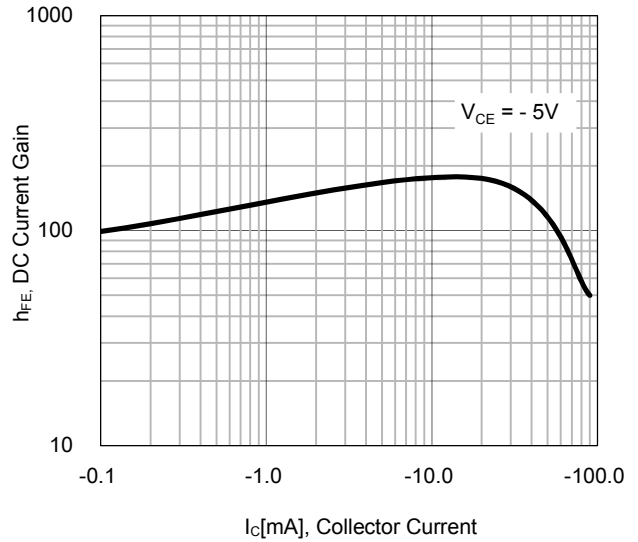

Fig.3 Base-Emitter Saturation Voltage VS. Collector-Emitter Saturation

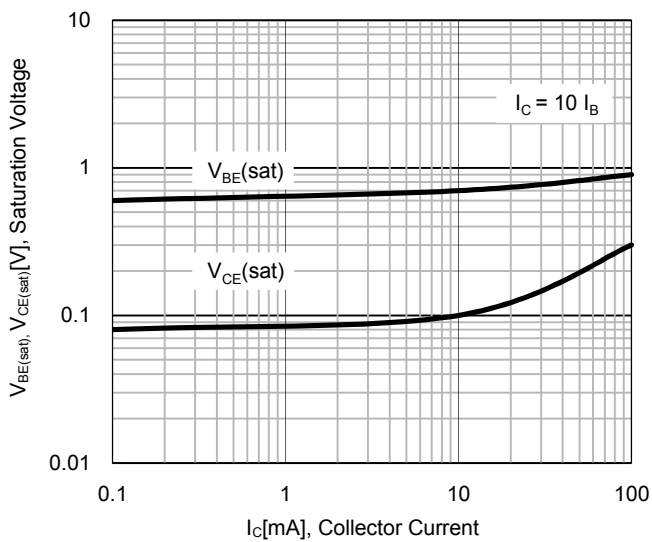
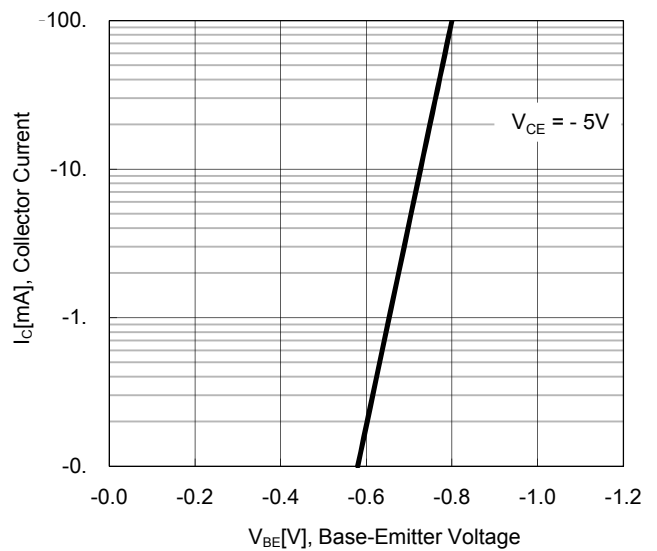

Fig.4 Base-Emitter On Voltage



CHARACTERISTICS CURVES

($T_A = 25^\circ\text{C}$ unless otherwise noted)

Fig.5 Collector Output Capacitance

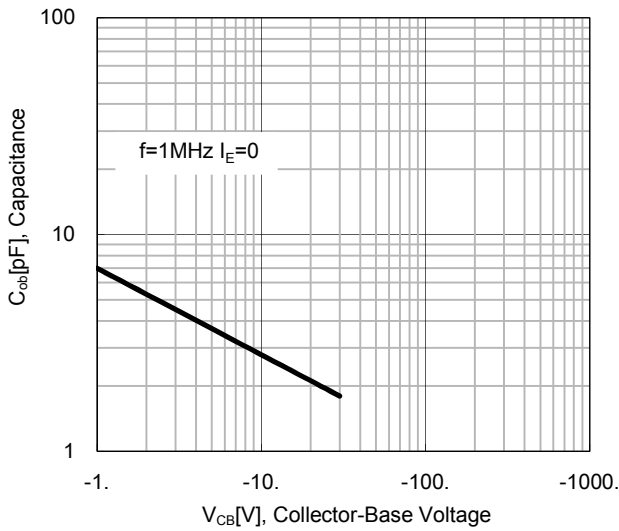

Fig. 6 Current Gain Bandwidth Product

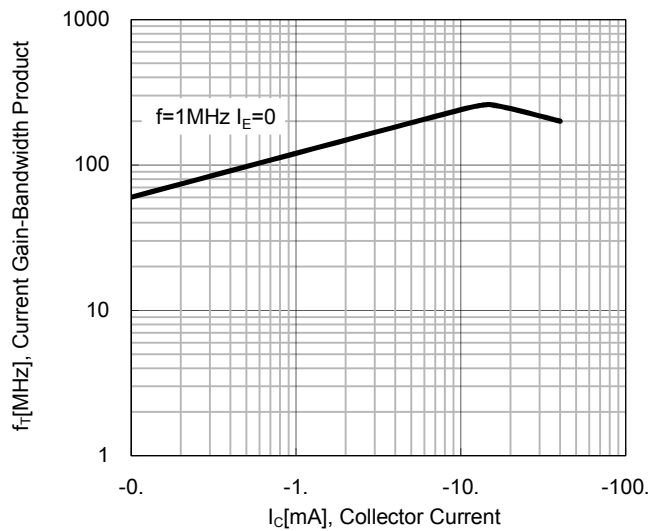

Fig.7 DC Current Gain as a Function of Collector Current; Typical Values

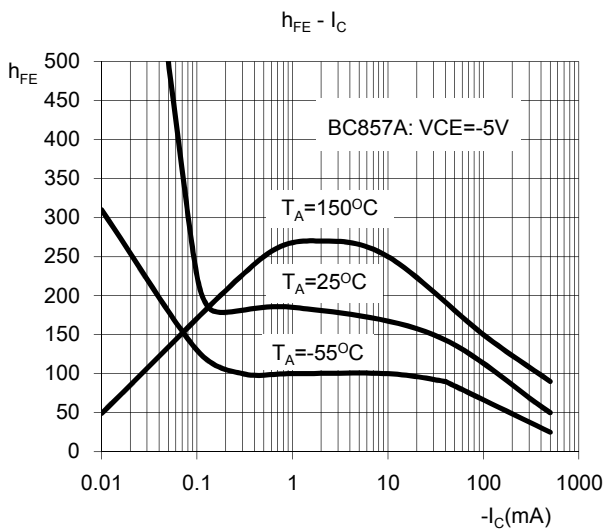
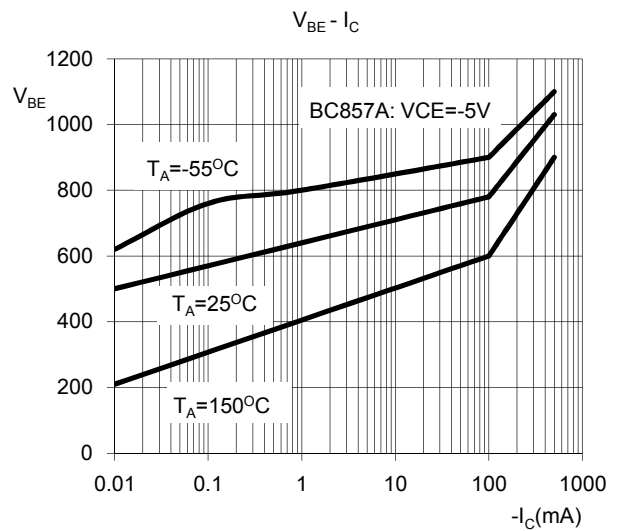
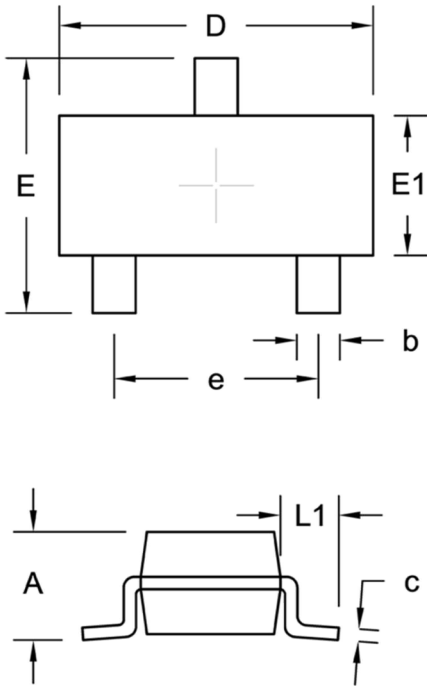

Fig.8 Base-Emitter Voltage as a Function of Collector Current; Typical Values



PACKAGE OUTLINE DIMENSION

SOT-23



DIM.	Unit (mm)		Unit (inch)	
	Min.	Max.	Min.	Max.
A	0.89	1.12	0.035	0.044
b	0.30	0.50	0.012	0.020
c	0.08	0.20	0.003	0.008
D	2.80	3.04	0.110	0.120
E	2.10	2.64	0.083	0.104
E1	1.20	1.40	0.047	0.055
e	1.90 BSC		0.075 BSC	
L1	0.54 REF.		0.021 REF.	

SUGGESTED PAD LAYOUT

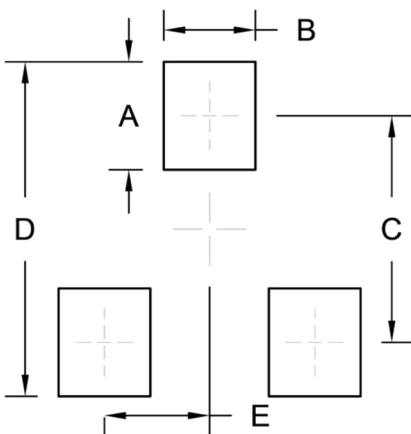

Symbol	Unit (mm)	Unit (inch)
A	1.00	0.039
B	0.85	0.033
C	2.10	0.083
D	3.10	0.122
E	0.98	0.039