

BCR16FM-12LB

600V - 16A - Triac

Medium Power Use

R07DS1188EJ0201

Rev.2.01

Feb. 19, 2019

Features

- $I_{T(RMS)}$: 16 A
- V_{DRM} : 600 V
- T_j : 150 °C
- I_{FGTI} , I_{RGTI} , $I_{RGT III}$: 30 mA(20mA)^{Note5}
- Insulated Type
- Planar Passivation Type
- Viso: 2000V

Outline

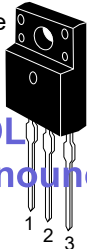
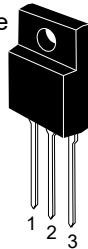
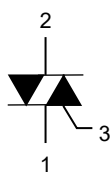
<p>RENESAS Package code: PRSS0003AG-A (Package name: TO-220FP) Ordering code #BB0</p>  <p>EOL announced</p>	<p>RENESAS Package code: PRSS0003AP-A (Package name: TO-220FPA) Ordering code #BG0 #BH0</p> 	 <p>1. T₁ Terminal 2. T₂ Terminal 3. Gate Terminal</p>
--	--	---

Application

Motor control, Heater control, Power supply, Solid state relay, and other general purpose AC control applications.

Maximum Ratings

Parameter	Symbol	Voltage class		Unit
		12		
Repetitive peak off-state voltage ^{Note1}	V_{DRM}	600		V
Non-repetitive peak off-state voltage ^{Note1}	V_{DSM}	720		V

Parameter	Symbol	Ratings	Unit	Conditions
RMS on-state current	$I_{T(RMS)}$	16	A	Commercial frequency, sine full wave 360°conduction, $T_c = 98^\circ\text{C}$ (#BB0, #BH0) ^{Note2} $T_c = 87^\circ\text{C}$ (#BG0) ^{Note2}
Surge on-state current	I_{TSM}	160	A	50 Hz sinewave 1 full cycle, peak value, non-repetitive
I^2t for fusion	I^2t	106.5	A ² s	Value corresponding to 1 cycle of half wave 50 Hz, surge on-state current
Peak gate power dissipation	P_{GM}	5	W	
Average gate power dissipation	$P_{G(AV)}$	0.5	W	
Peak gate voltage	V_{GM}	10	V	
Peak gate current	I_{GM}	2	A	
Junction Temperature	T_j	-40 to +150	°C	
Storage temperature	T_{stg}	-40 to +150	°C	
Isolation voltage ^{Note7}	V_{iso}	2000	V	$T_a=25^\circ\text{C}$, AC 1 minute, $T_1 \cdot T_2 \cdot G$ terminal to case

- Notes: 1. Gate open.
2. Please refer to the Ordering Information.

Electrical Characteristics

Parameter	Symbol	Min.	Typ.	Max.	Unit	Test conditions	
Repetitive peak off-state current	I_{DRM}	—	—	2.0	mA	$T_j = 150^\circ\text{C}$, V_{DRM} applied	
On-state voltage	V_{TM}	—	—	1.5	V	$T_c = 25^\circ\text{C}$, $I_{TM} = 25\text{ A}$, instantaneous measurement	
Gate trigger voltage ^{Note3}	I	V_{FGTI}	—	—	1.5	V	$T_j = 25^\circ\text{C}$, $V_D = 6\text{ V}$, $R_L = 6\ \Omega$, $R_G = 330\ \Omega$
	II	V_{RGTI}	—	—	1.5	V	
	III	V_{RGTIII}	—	—	1.5	V	
Gate trigger current ^{Note3}	I	I_{FGTI}	—	—	30 ^{Note6}	mA	$T_j = 25^\circ\text{C}$, $V_D = 6\text{ V}$, $R_L = 6\ \Omega$, $R_G = 330\ \Omega$
	II	I_{RGTI}	—	—	30 ^{Note6}	mA	
	III	I_{RGTIII}	—	—	30 ^{Note6}	mA	
Gate non-trigger voltage	V_{GD}	0.2	—	—	V	$T_j = 125^\circ\text{C}$, $V_D = 1/2 V_{DRM}$	
		0.1	—	—		$T_j = 150^\circ\text{C}$, $V_D = 1/2 V_{DRM}$	
Thermal resistance	$R_{th(j-c)}$	—	—	2.9	$^\circ\text{C/W}$	Junction to case ^{Note4} (#BB0, #BH0) ^{Note2}	
		—	—	3.5	$^\circ\text{C/W}$	Junction to case ^{Note4} (#BG0) ^{Note2}	
Critical-rate of rise of off-state commutation voltage ^{Note5}	$(dv/dt)_c$	10	—	—	V/ μs	$T_j = 125^\circ\text{C}$	
		1	—	—		$T_j = 150^\circ\text{C}$	

Notes: 3. Measurement using the gate trigger characteristics measurement circuit.

4. The contact thermal resistance $R_{th(c-f)}$ in case of greasing is 0.5°C/W .

5. Test conditions of the critical-rate of rise of off-state commutation voltage is shown in the table below.

6. High sensitivity ($I_{GT} \leq 20\text{ mA}$) is also available. (I_{GT} item:1)

7. Make sure that your finished product containing this device meets your safe isolation requirements.

For safety, it's advisable that heatsink is electrically floating.

Test conditions	Commutating voltage and current waveforms (inductive load)
1. Junction temperature $T_j = 125^\circ\text{C}/150^\circ\text{C}$ 2. Rate of decay of on-state commutating current $(di/dt)_c = -8\text{ A/ms}$ 3. Peak off-state voltage $V_D = 400\text{ V}$	

Performance Curves

Maximum On-State Characteristics

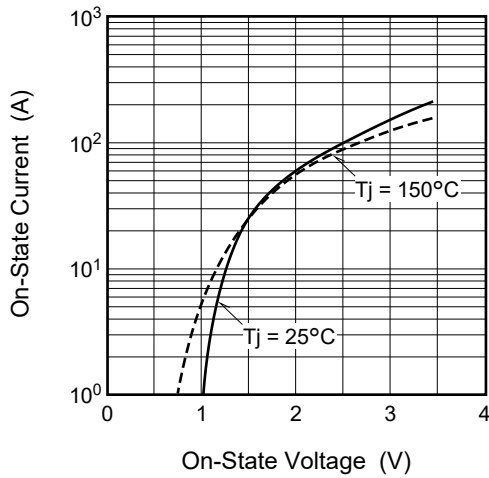

Rated Surge On-State Current

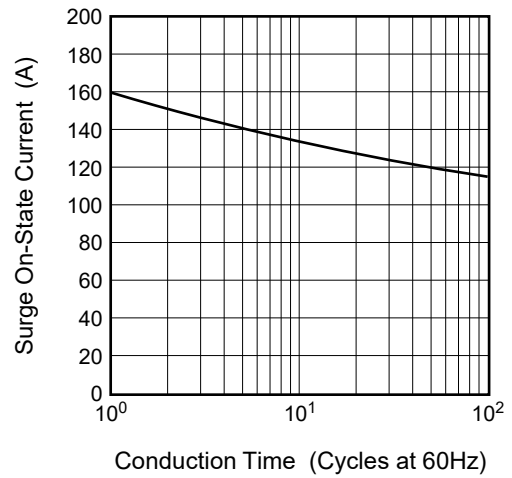

Gate Characteristics (I, II and III)

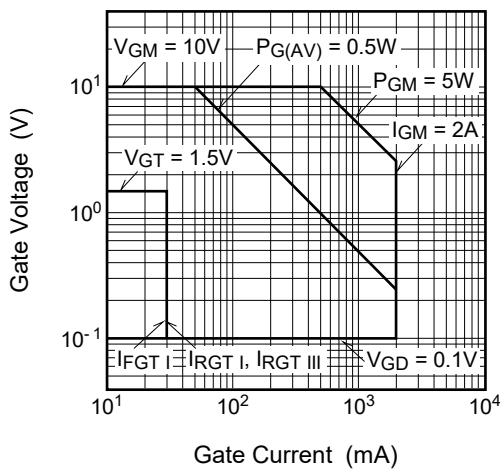

Gate Trigger Current vs. Junction Temperature

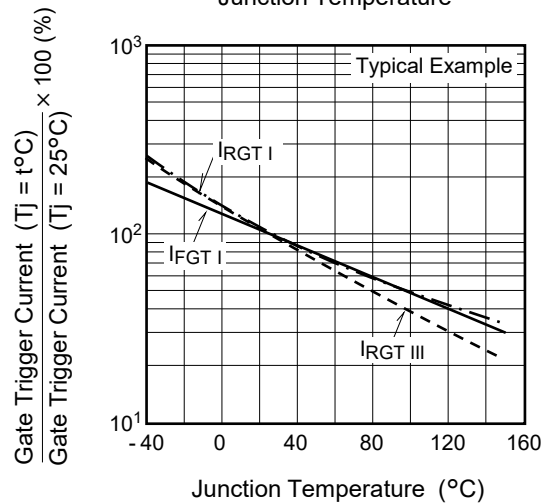

Gate Trigger Voltage vs. Junction Temperature

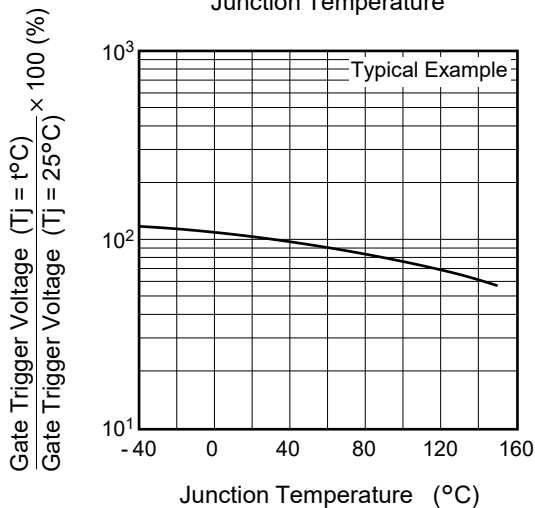

Gate Trigger Current vs. Gate Current Pulse Width

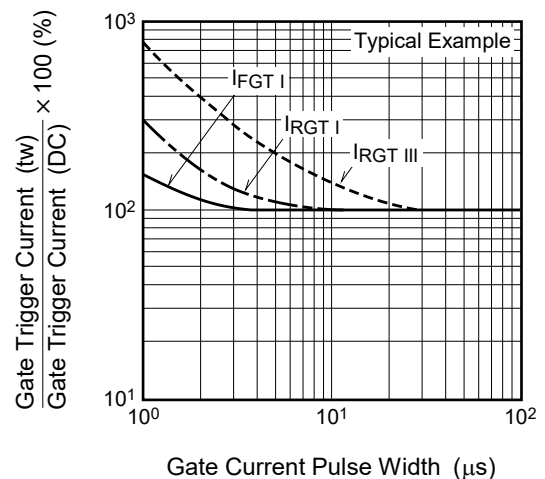

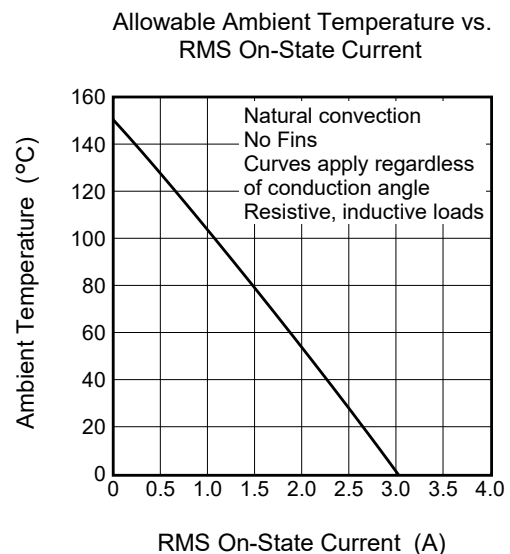
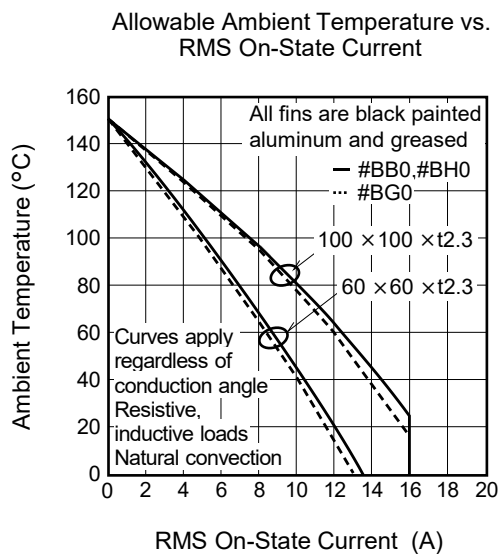
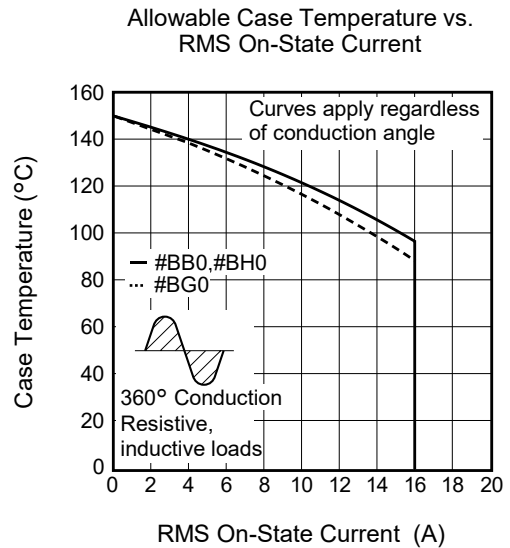
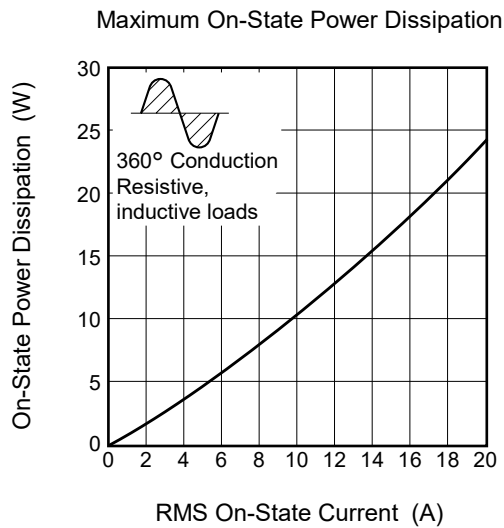
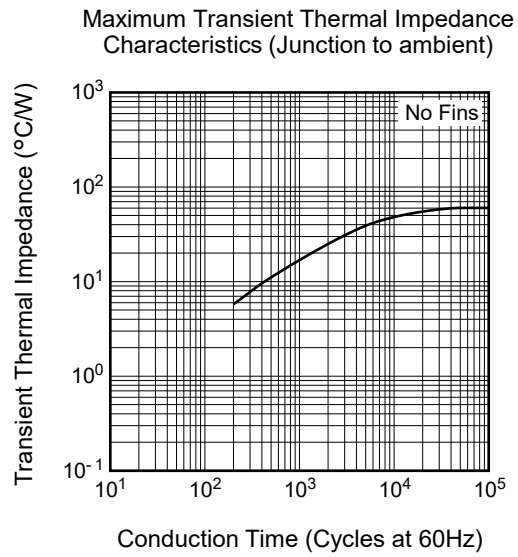
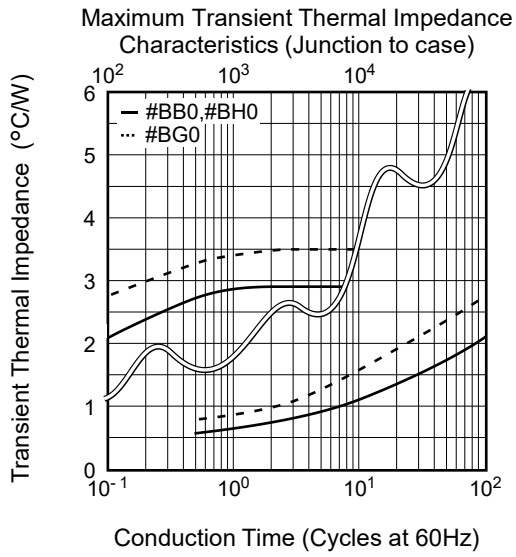

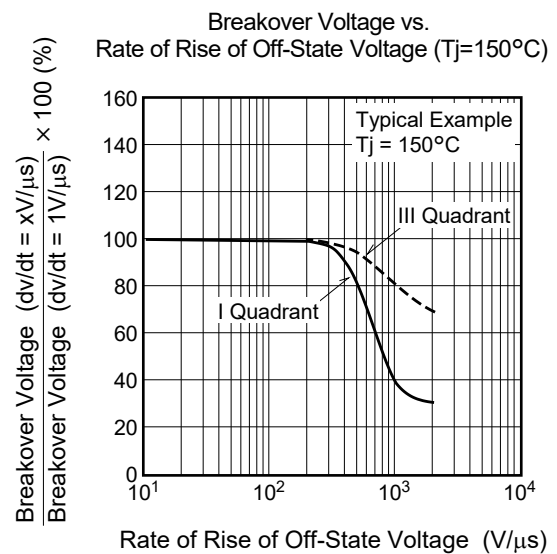
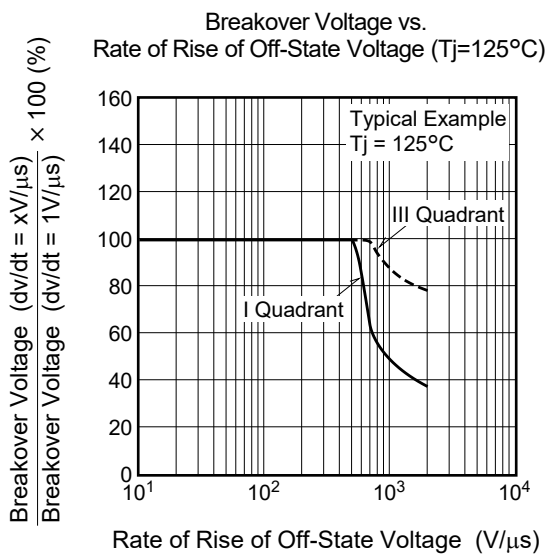
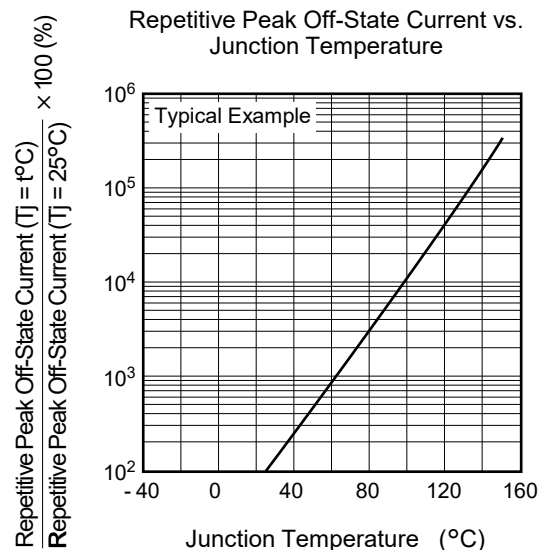
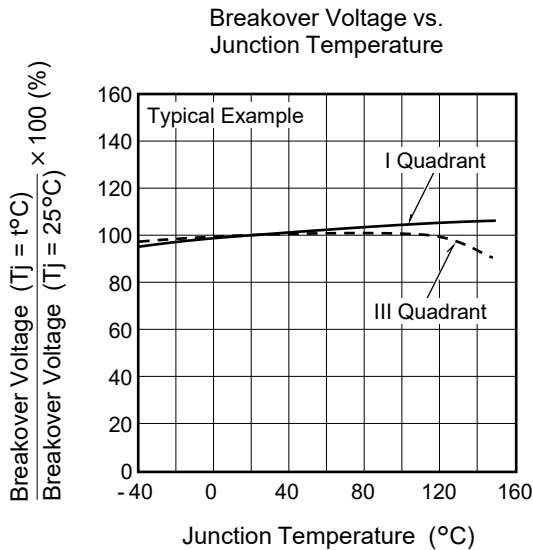
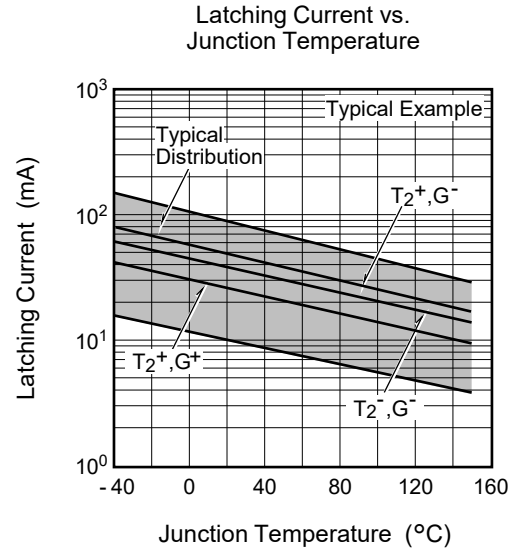
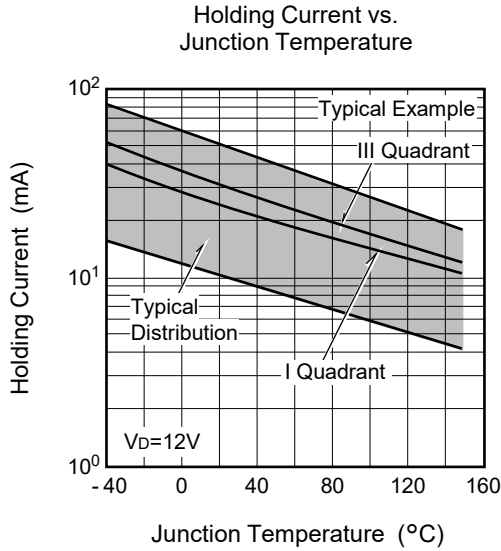

Commutation Characteristics (Tj=125°C)

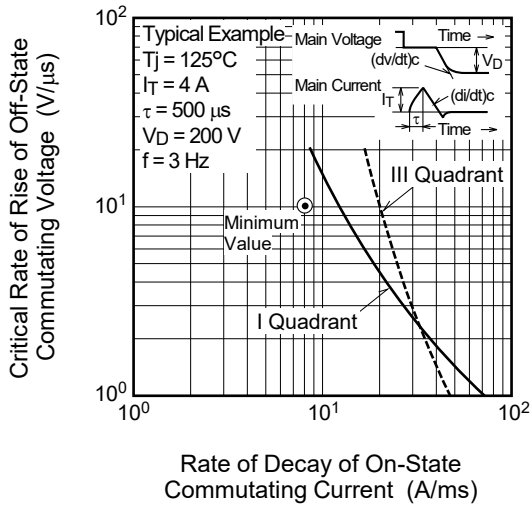

Commutation Characteristics (Tj=150°C)

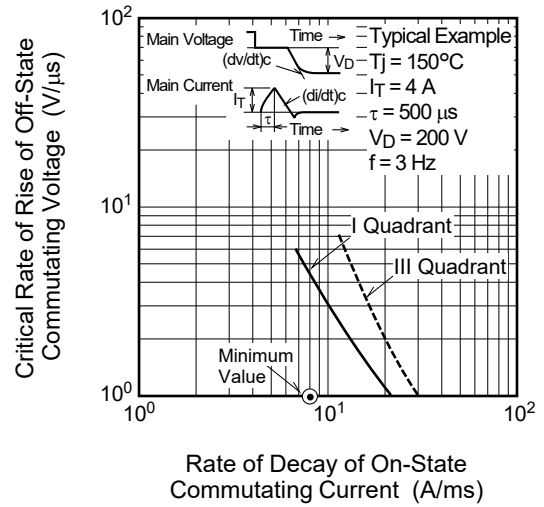

Gate Trigger Characteristics Test Circuits

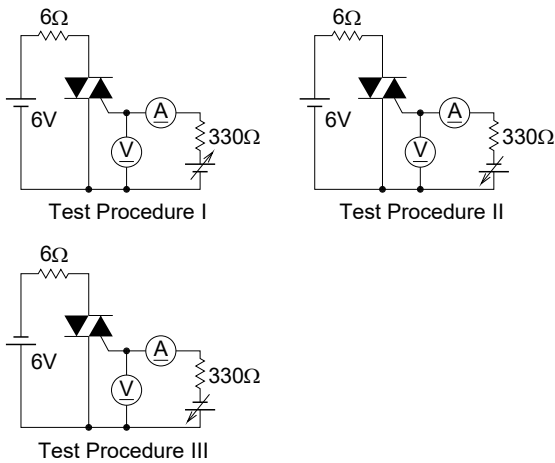

Recommended peripheral components for Triac

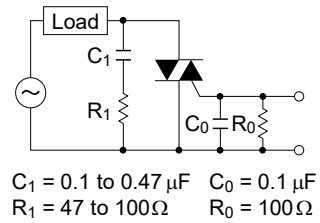

Package Dimensions

Ordering code: #BG0, #BH0

JEITA Package Code	RENESAS Code	Previous Code	MASS (Typ) [g]
-	PRSS0003AP-A	TO-220FPA	1.65

Unit: mm

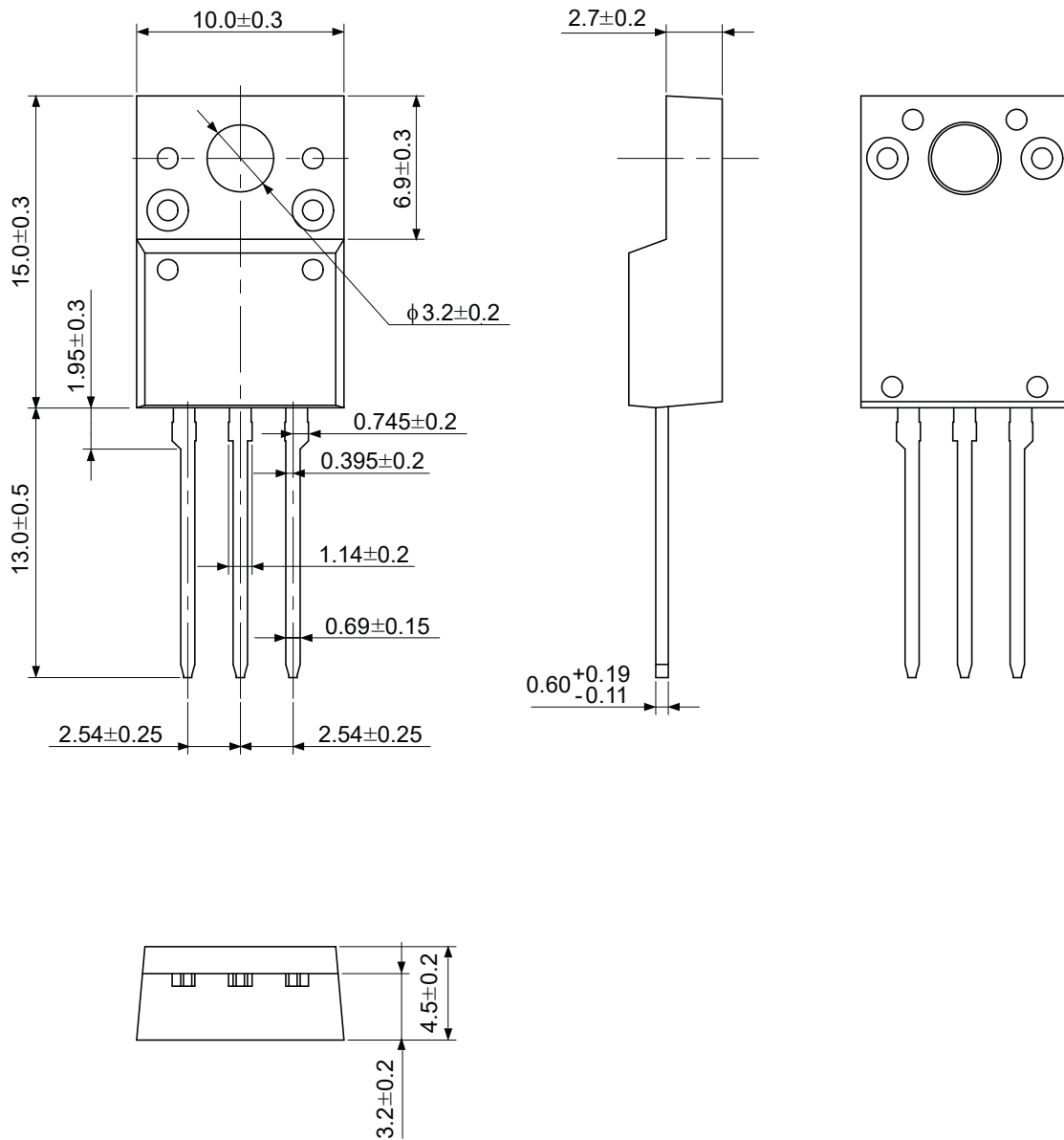

Package Dimensions

Ordering code: #BB0 <EOL announced>

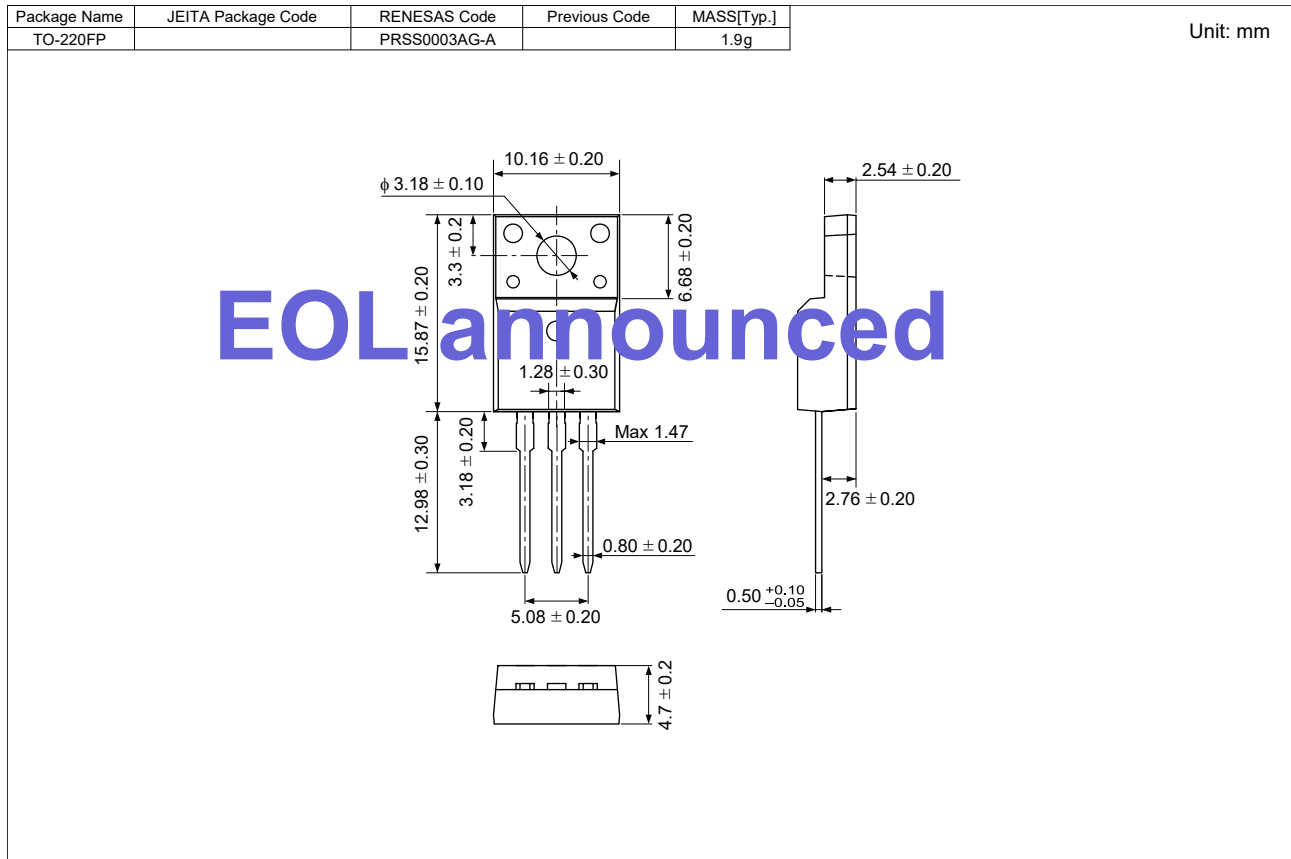

Ordering Information

Orderable Part Number	Package	Quantity ^{Note8}	Remark	Status
BCR16FM-12LB#BG0	TO-220FPA	50 pcs./ tube	Straight type	Mass Production
BCR16FM-12LB-1#BG0	TO-220FPA	50 pcs./ tube	Straight type, IGT item:1	
BCR16FM-12LB□□#BG0	TO-220FPA	50 pcs./ tube	□□:Lead form type	
BCR16FM12LB1□□#BG0	TO-220FPA	50 pcs./ tube	□□:Lead form type, IGT item:1	
BCR16FM-12LB#BH0	TO-220FPA	50 pcs./ tube	Straight type	
BCR16FM-12LB-1#BH0	TO-220FPA	50 pcs./ tube	Straight type, IGT item:1	
BCR16FM-12LB□□#BH0	TO-220FPA	50 pcs./ tube	□□:Lead form type	
BCR16FM12LB1□□#BH0	TO-220FPA	50 pcs./ tube	□□:Lead form type, IGT item:1	
BCR16FM-12LB#BB0	TO-220FP	50 pcs./ tube	Straight type	EOL announced
BCR16FM-12LB-1#BB0	TO-220FP	50 pcs./ tube	Straight type, IGT item:1	
BCR16FM12LB1□□#BB0	TO-220FP	50 pcs./ tube	□□:Lead form type, IGT item:1	

Notes: 8. Please confirm the specification about the shipping in detail.