

# BCR5AS-12B

600V - 5A - Triac

Medium Power Use

R07DS1442EJ0500  
 (Previous: REJ03G0451-0400)  
 Rev.5.00  
 May. 10, 2019

## Features

- $I_{T(RMS)}$  : 5 A
- $V_{DRM}$  : 600 V
- $I_{FGT}$ ,  $I_{RGT}$ ,  $I_{RGT III}$ : 30 mA
- $T_j$ : 150 °C
- Planar Passivation Type

## Outline

RENESAS Package code: PRSS0004ZG-A  
 (Package name: MP-3A)

1. T<sub>1</sub> Terminal  
 2. T<sub>2</sub> Terminal  
 3. Gate Terminal  
 4. T<sub>2</sub> Terminal

## Application

Small motor control, heater control, and other general purpose AC control applications.

## Maximum Ratings

Parameter	Symbol	Voltage class	Unit
		12	
Repetitive peak off-state voltage <sup>Note1</sup>	$V_{DRM}$	600	V
Non-repetitive peak off-state voltage <sup>Note1</sup>	$V_{DSM}$	720	V

Notes: 1. Gate open.

Parameter	Symbol	Ratings	Unit	Conditions
RMS on-state current	$I_{T(RMS)}$	5	A	Commercial frequency, sine full wave 360°conduction, $T_c = 128^\circ\text{C}$ <sup>Note3</sup>
Surge on-state current	$I_{TSM}$	50	A	60 Hz sinewave 1 full cycle, peak value, non-repetitive
$I^2t$ for fusing	$I^2t$	10.4	A <sup>2</sup> s	Value corresponding to 1 cycle of half wave 60 Hz, surge on-state current
Peak gate power dissipation	$P_{GM}$	3	W	
Average gate power dissipation	$P_{G(AV)}$	0.3	W	
Peak gate voltage	$V_{GM}$	10	V	
Peak gate current	$I_{GM}$	2	A	
Junction Temperature	$T_j$	-40 to +150	°C	
Storage temperature	$T_{stg}$	-40 to +150	°C	

## Electrical Characteristics

Parameter	Symbol	Min.	Typ.	Max.	Unit	Test conditions	
Repetitive peak off-state current	$I_{DRM}$	—	—	2.0	mA	$T_j = 150^\circ\text{C}$ , $V_{DRM}$ applied	
On-state voltage	$V_{TM}$	—	—	1.8	V	$T_c = 25^\circ\text{C}$ , $I_{TM} = 7\text{ A}$ , instantaneous measurement	
Gate trigger voltage <sup>Note2</sup>	I	$V_{FGTI}$	—	—	1.5	V	$T_j = 25^\circ\text{C}$ , $V_D = 6\text{ V}$ , $R_L = 6\ \Omega$ , $R_G = 330\ \Omega$
	II	$V_{RGTI}$	—	—	1.5	V	
	III	$V_{RGTIII}$	—	—	1.5	V	
Gate trigger current <sup>Note2</sup>	I	$I_{FGTI}$	—	—	30	mA	$T_j = 25^\circ\text{C}$ , $V_D = 6\text{ V}$ , $R_L = 6\ \Omega$ , $R_G = 330\ \Omega$
	II	$I_{RGTI}$	—	—	30	mA	
	III	$I_{RGTIII}$	—	—	30	mA	
Gate non-trigger voltage	$V_{GD}$	0.2	—	—	V	$T_j = 125^\circ\text{C}$ , $V_D = 1/2 V_{DRM}$	
		0.1	—	—		$T_j = 150^\circ\text{C}$ , $V_D = 1/2 V_{DRM}$	
Thermal resistance	$R_{th(j-c)}$	—	—	3.0	$^\circ\text{C/W}$	Junction to case <sup>Note3</sup>	
Critical-rate of rise of off-state commutating voltage <sup>Note4</sup>	$(dv/dt)_c$	5	—	—	V/ $\mu\text{s}$	$T_j = 125^\circ\text{C}$	
		1	—	—		$T_j = 150^\circ\text{C}$	

Notes: 2. Measurement using the gate trigger characteristics measurement circuit.

3. Case temperature is measured on the  $T_2$  tab.

4. Test conditions of the critical-rate of rise of off-state commutating voltage is shown in the table below.

Test conditions	Commutating voltage and current waveforms (inductive load)
1. Junction temperature $T_j = 125^\circ\text{C}/150^\circ\text{C}$ 2. Rate of decay of on-state commutating current $(di/dt)_c = -2.5\text{ A/ms}$ 3. Peak off-state voltage $V_D = 400\text{ V}$	

Performance Curves

Maximum On-State Characteristics

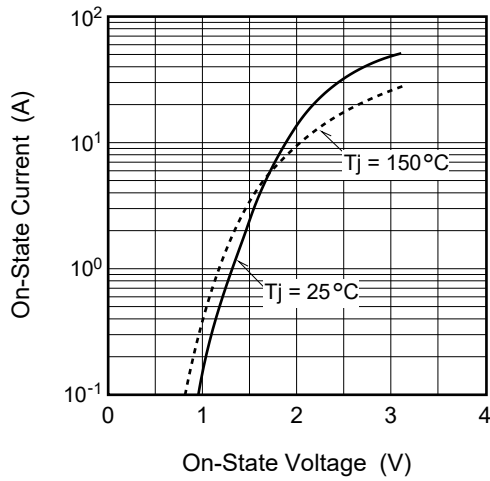

Rated Surge On-State Current

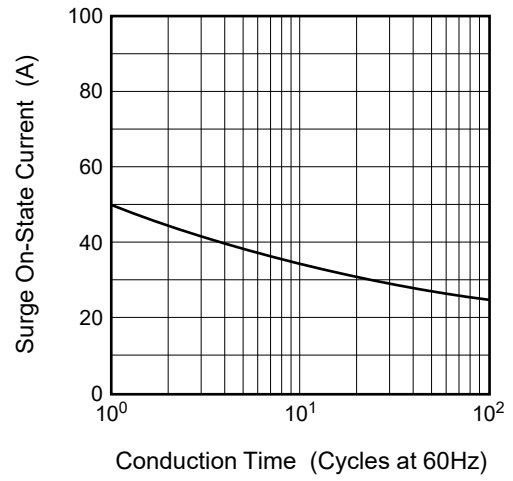

Gate Characteristics (I, II and III)

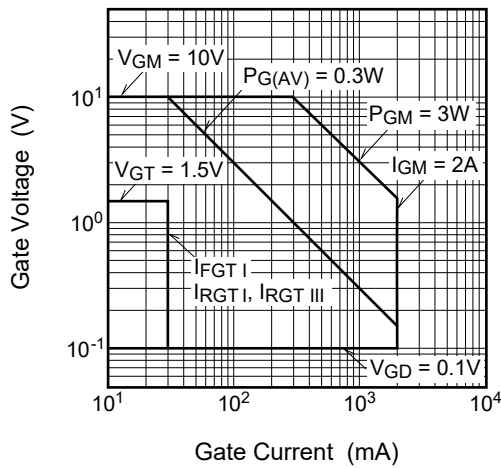

Gate Trigger Current vs. Junction Temperature

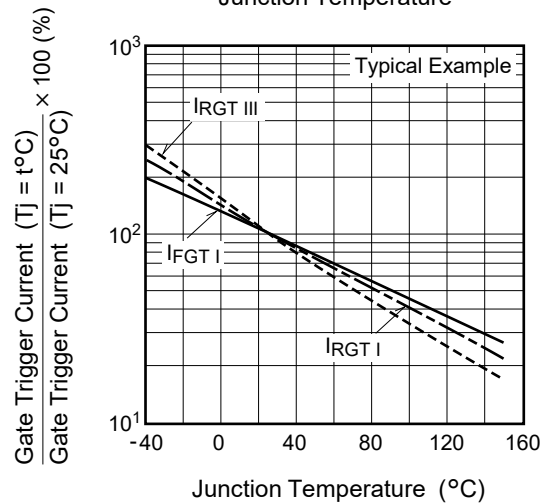

Gate Trigger Voltage vs. Junction Temperature

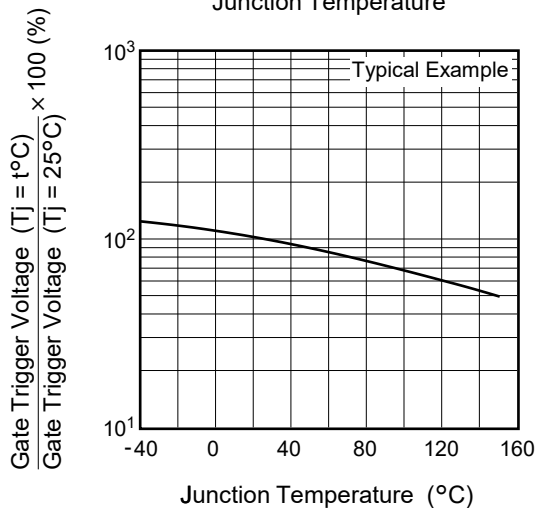

Gate Trigger Current vs. Gate Current Pulse Width

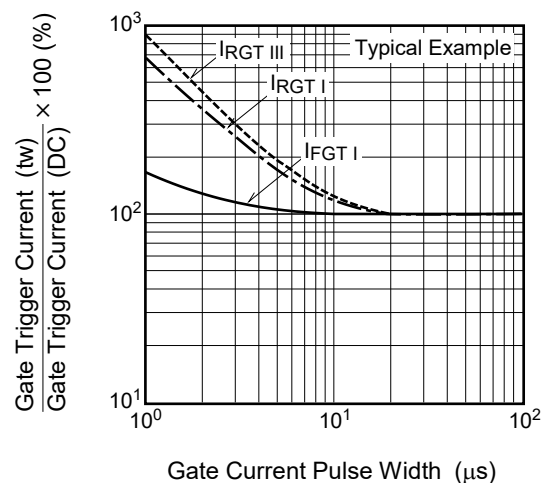

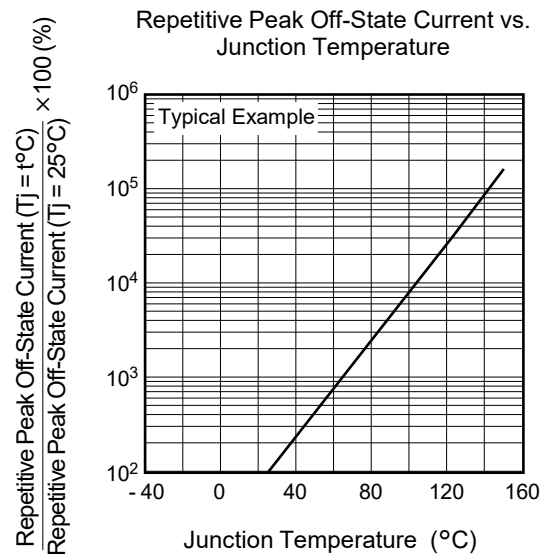
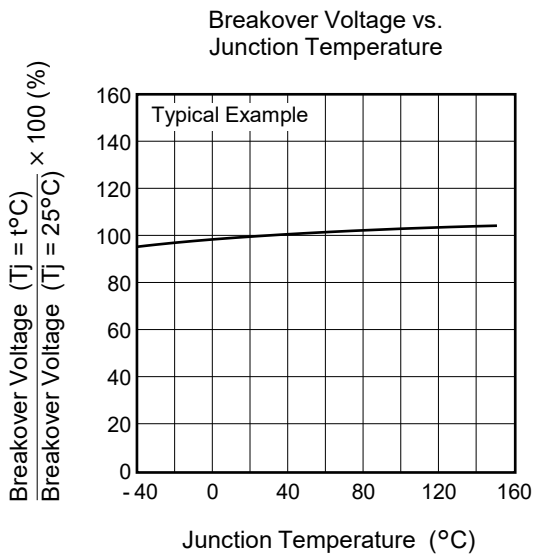
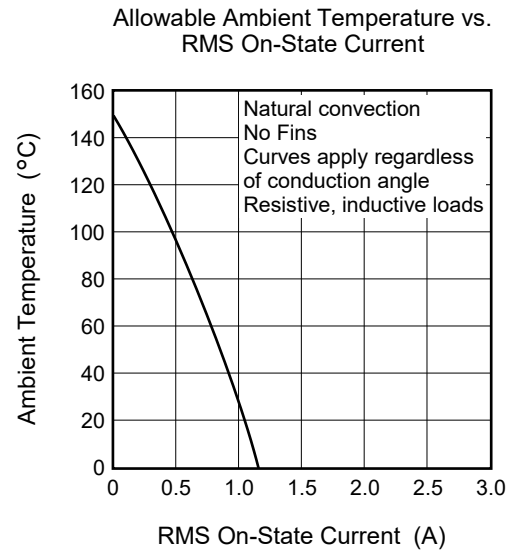
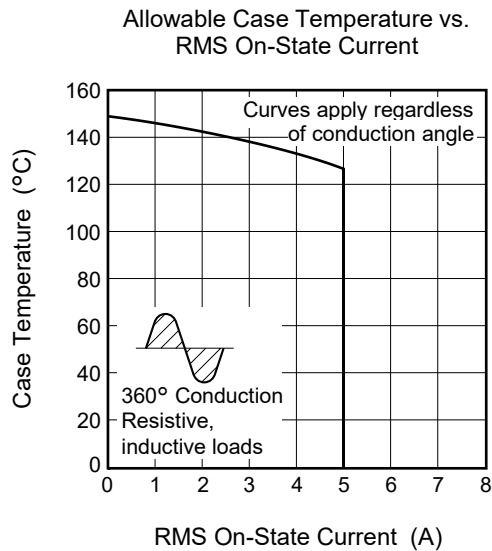
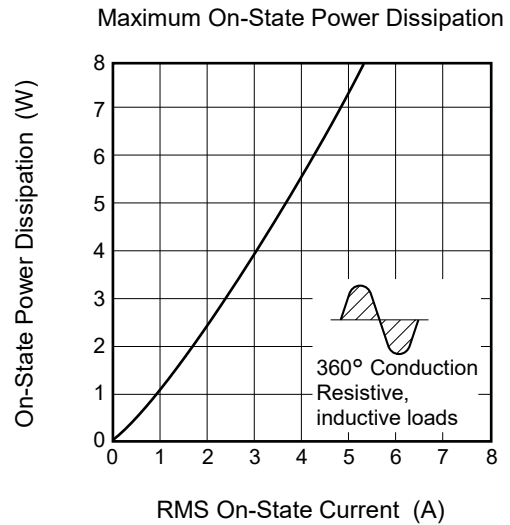
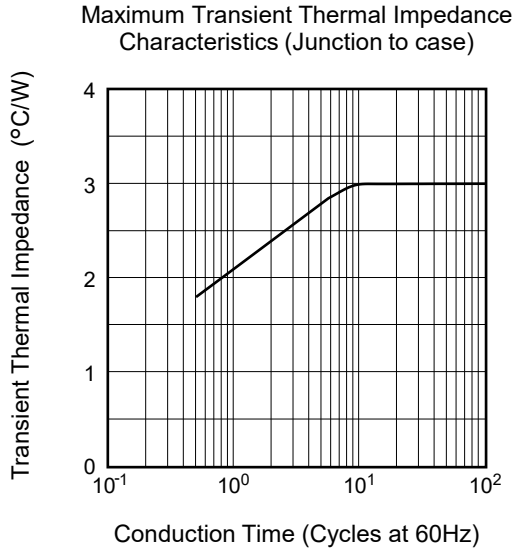

Holding Current vs. Junction Temperature

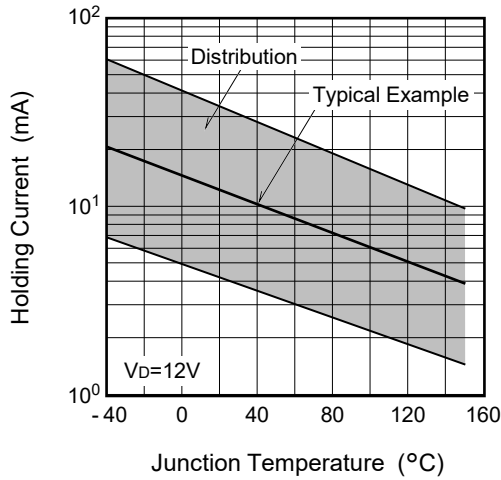

Latching Current vs. Junction Temperature

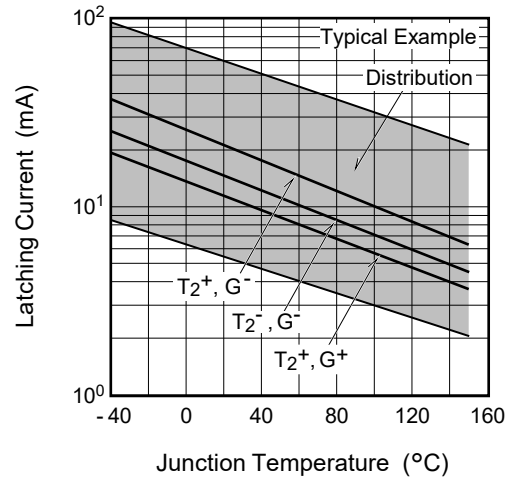

Breakover Voltage vs. Rate of Rise of Off-State Voltage (T<sub>J</sub>=125°C)

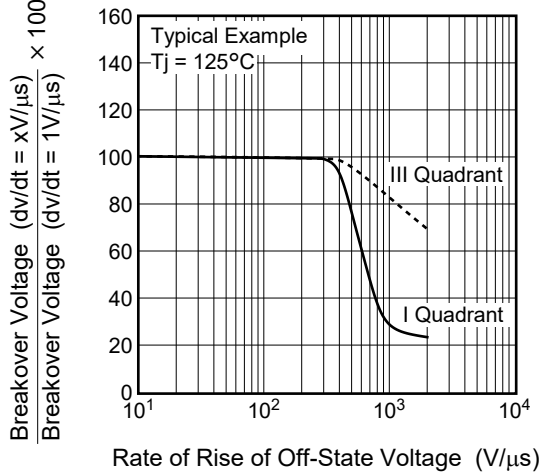

Breakover Voltage vs. Rate of Rise of Off-State Voltage (T<sub>J</sub>=150°C)

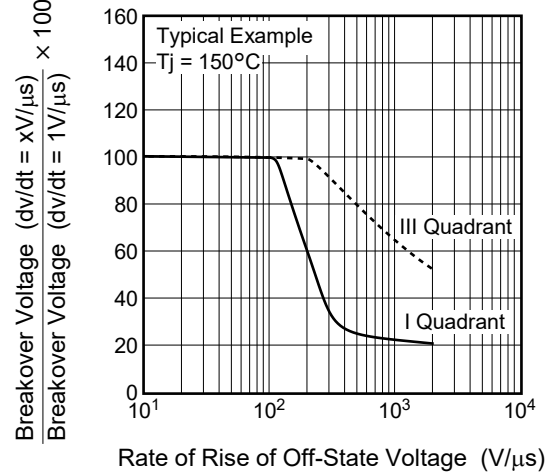

Commutation Characteristics (T<sub>J</sub>=125°C)

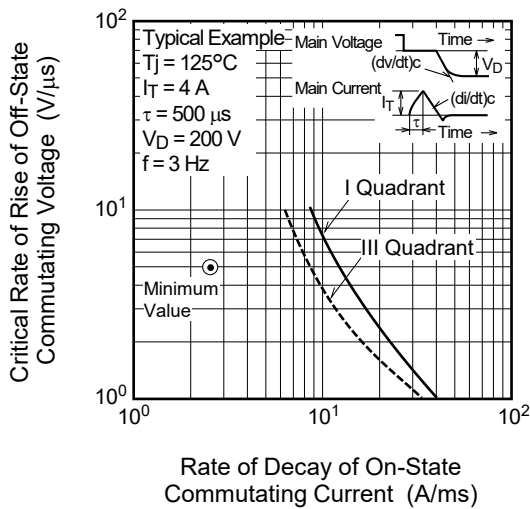

Commutation Characteristics (T<sub>J</sub>=150°C)

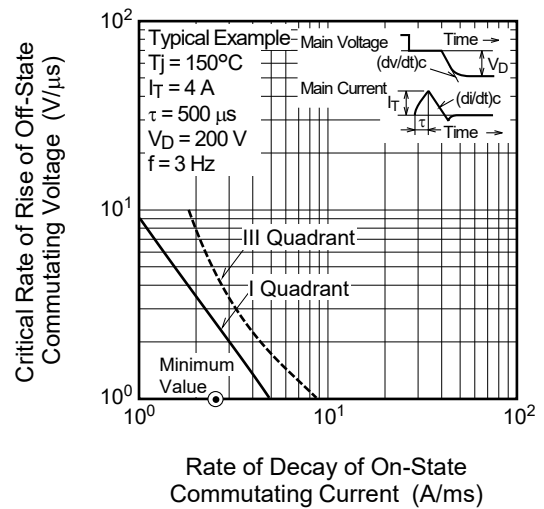

Gate Trigger Characteristics Test Circuits

Recommended peripheral components for Triac

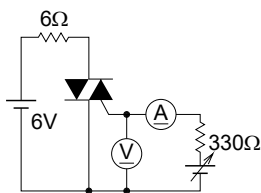

Test Procedure I

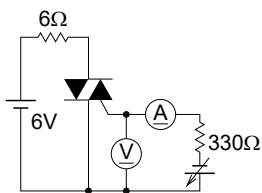

Test Procedure II

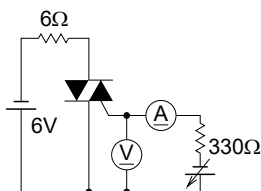

Test Procedure III

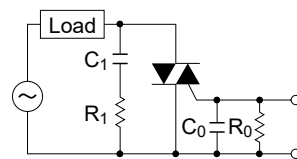

$C_1 = 0.1 \text{ to } 0.47 \mu\text{F}$      $C_0 = 0.1 \mu\text{F}$   
 $R_1 = 47 \text{ to } 100\Omega$      $R_0 = 100\Omega$

## Package Dimensions

Package Name: MP-3A

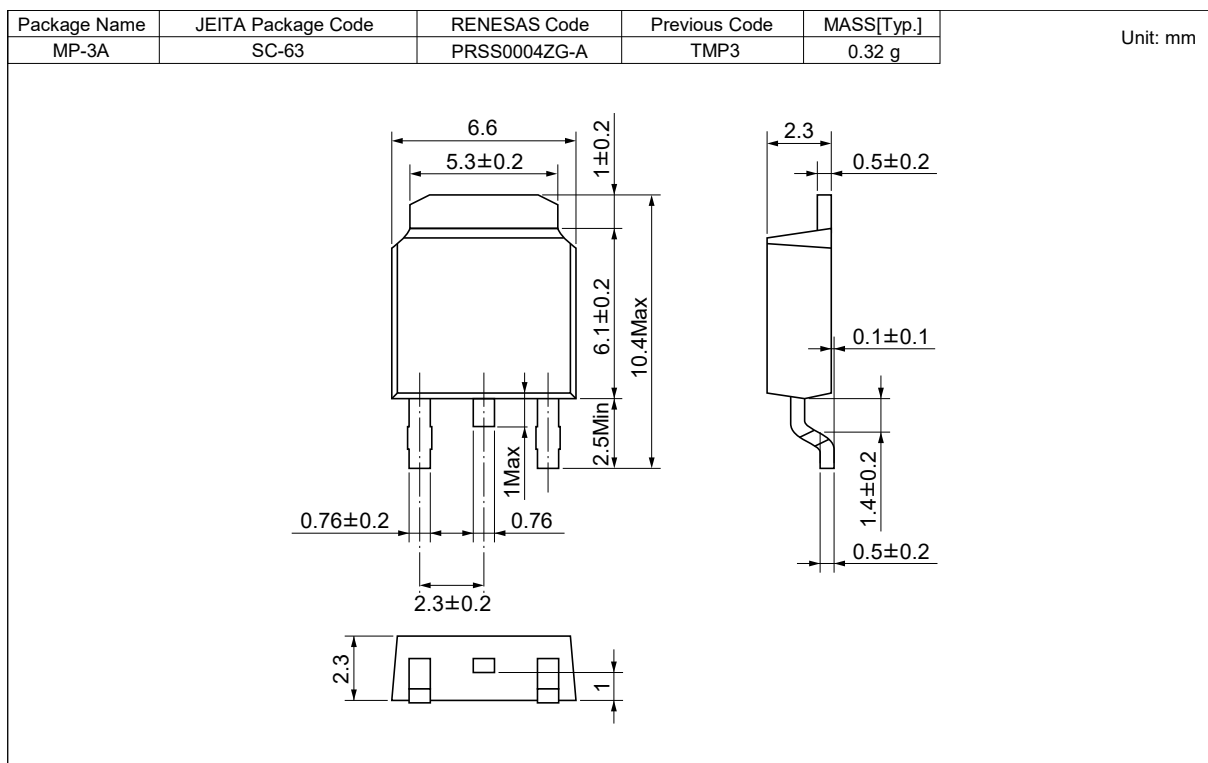

## Ordering Information

Orderable Part Number	Package	Packing <sup>Note5</sup>	Quantity	Remark
BCR5AS-12B-T13#B01	MP-3A	Embossed tape	3000 pcs.	
BCR5AS-12B#B01	MP-3A	Tube	75 pcs.	Tube packing is to be abolished.

Note: 5. Please confirm the specification about the shipping in detail.