



BD1040CS~BD10200CS

SURFACE MOUNT SCHOTTKY BARRIER RECTIFIERS

Voltage

40~200 V

Current

10 A

TO-252

Unit : inch(mm)

Features

- Plastic package has Underwriters Laboratory Flammability Classification 94V-O.
- For through hole applications
- Low power loss, High efficiency
- High surge capacity
- For use in low voltage, high frequency inverters free wheeling, and polarity protection applications
- Lead free in compliance with EU RoHS 2011/65/EU directive.
- Green molding compound as per IEC61249 Std..(Halogen Free)

Mechanical Data

- Case: TO-252 Molded plastic
- Terminals: Solder plated, solderable per MIL-STD-750, Method 2026
- Polarity: As marking
- Standard packaging: 16mm tape (EIA-481)
- Approx. Weight: 0.0104 ounces, 0.297 grams
- Marking: Part number

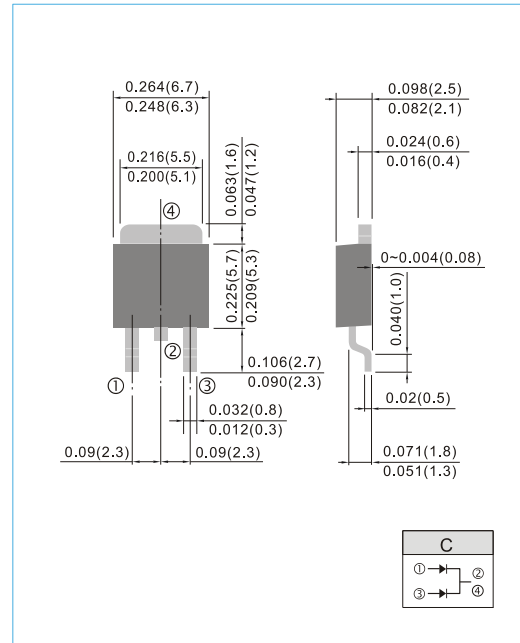

Maximum Ratings ($T_A=25^{\circ}\text{C}$ unless otherwise noted)

PARAMETER	SYMBOL	BD1040CS	BD1045CS	BD1050CS	BD1060CS	BD1080CS	BD1090CS	BD10100CS	BD10150CS	BD10200CS	UNIT	
Maximum repetitive peak reverse voltage	V_{RRM}	40	45	50	60	80	90	100	150	200	V	
Maximum rms voltage	V_{RMS}	28	31.5	35	42	56	63	70	105	140	V	
Maximum dc blocking voltage	V_R	40	45	50	60	80	90	100	150	200	V	
Maximum average forward rectified current	$I_{F(AV)}$	10									A	
Peak forward surge current : 8.3ms single half sine-wave superimposed on rated load	I_{FSM}	100									A	
Maximum forward voltage at 5A per diode	V_F	0.7		0.75		0.8		0.9			V	
Maximum dc reverse current at rated dc blocking voltage	I_R	0.05									20	mA
Typical thermal resistance	$R_{\theta JC}$	3									$^{\circ}\text{C/W}$	
Operating junction and storage temperature range	T_J, T_{STG}	-55 to +150				-65 to +175					$^{\circ}\text{C}$	

Note: Both Bonding and Chip structure are available.



BD1040CS~BD10200CS

TYPICAL CHARACTERISTIC CURVES

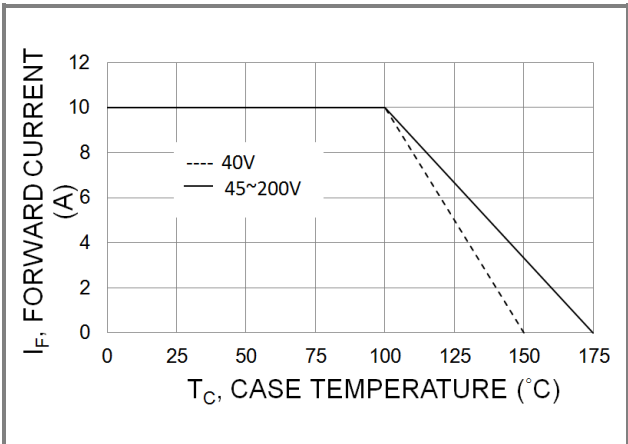

Fig.1 Forward Current Derating Curve

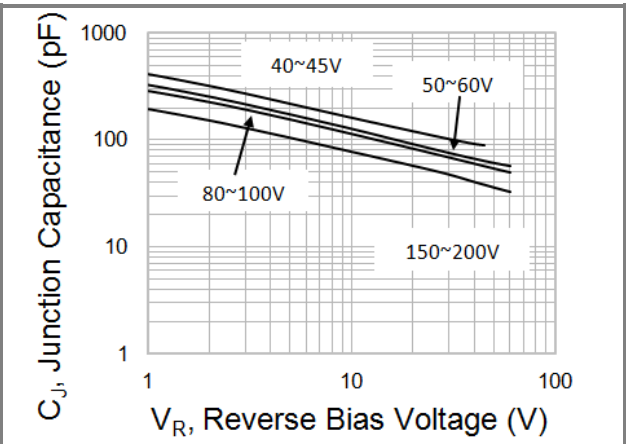

Fig.2 Typical Junction Capacitance

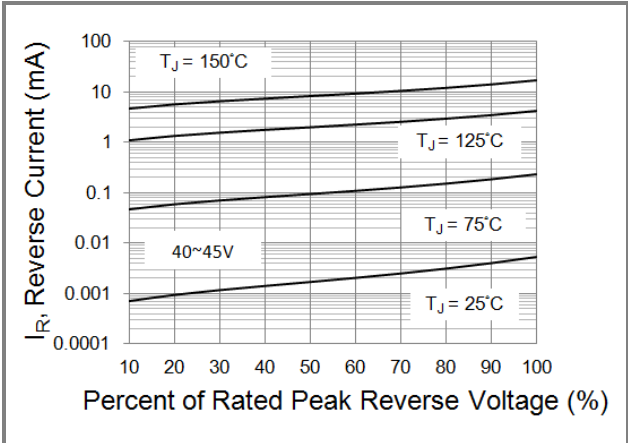

Fig.3 Typical Reverse Characteristics

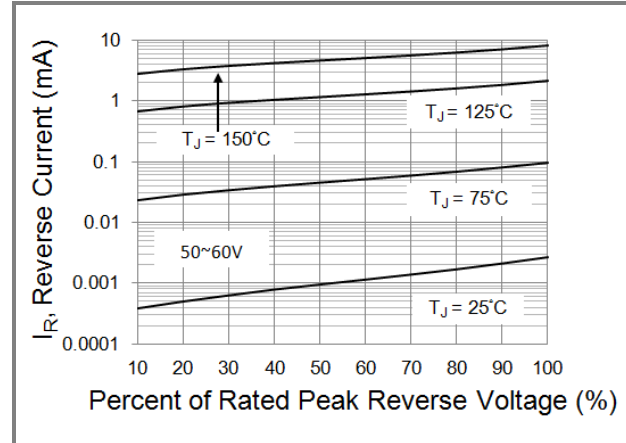

Fig.4 Typical Reverse Characteristics

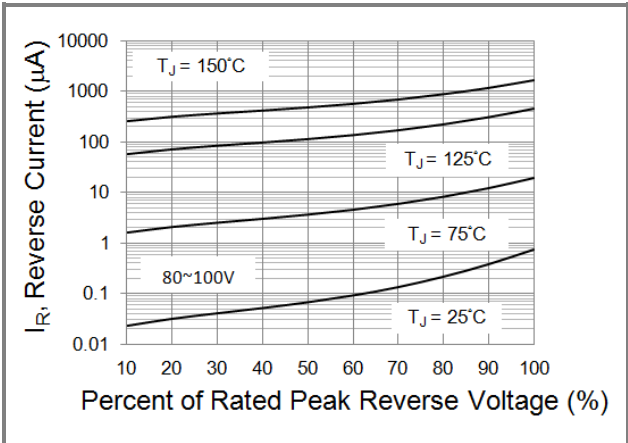

Fig.5 Typical Reverse Characteristics

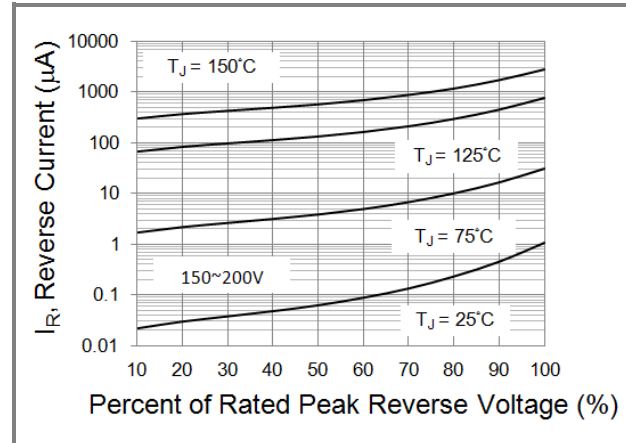

Fig.6 Typical Reverse Characteristics



BD1040CS~BD10200CS

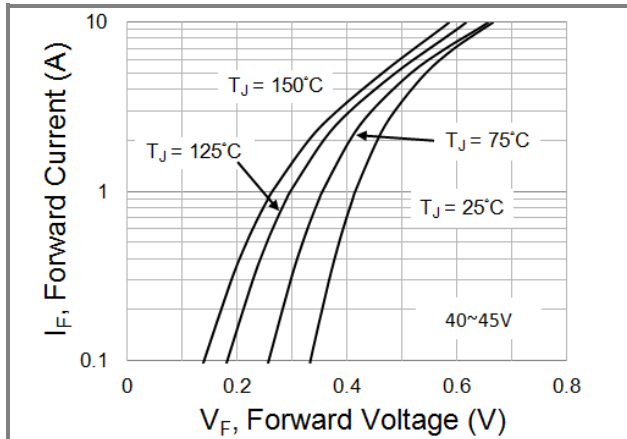

Fig.7 Typical Forward Characteristics

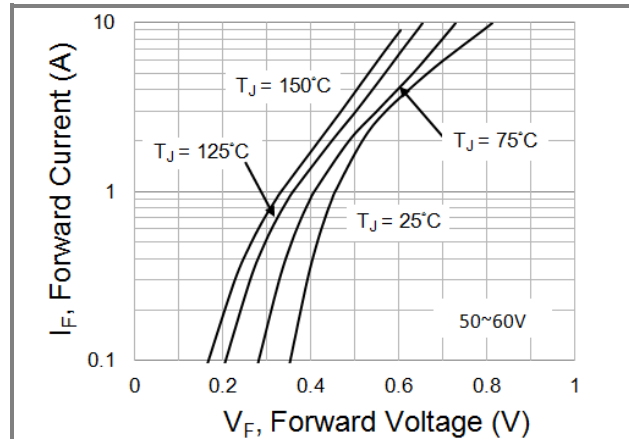

Fig.8 Typical Forward Characteristics

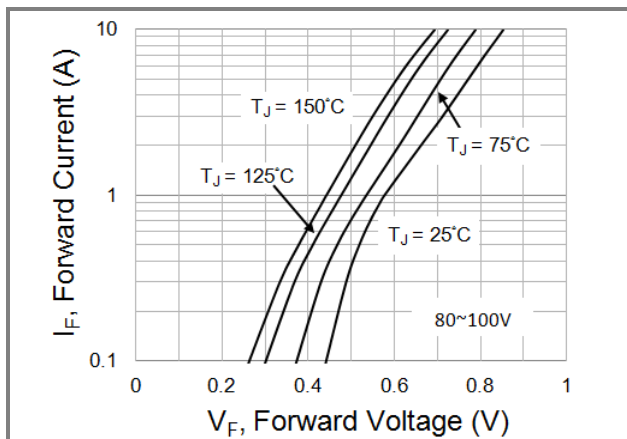

Fig.9 Typical Forward Characteristics

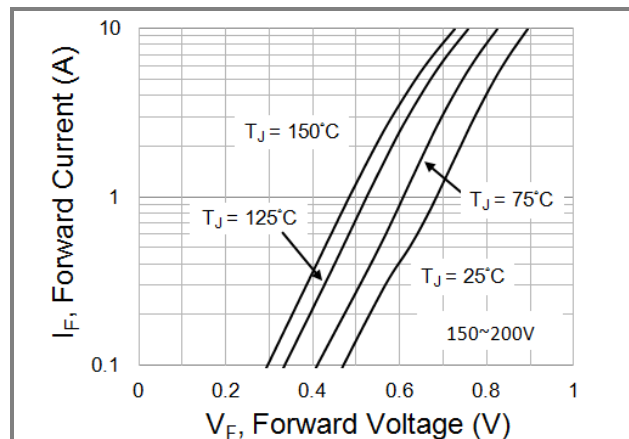

Fig.10 Typical Forward Characteristics

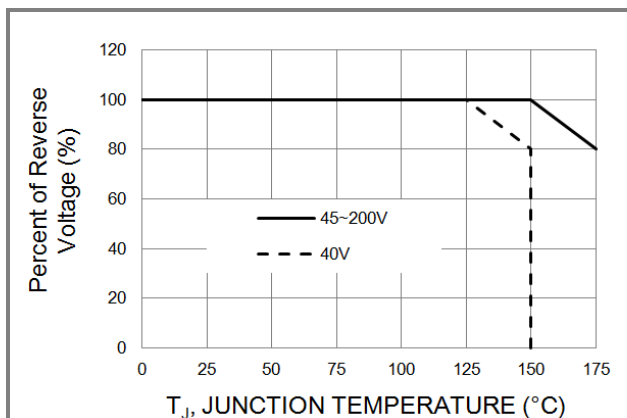
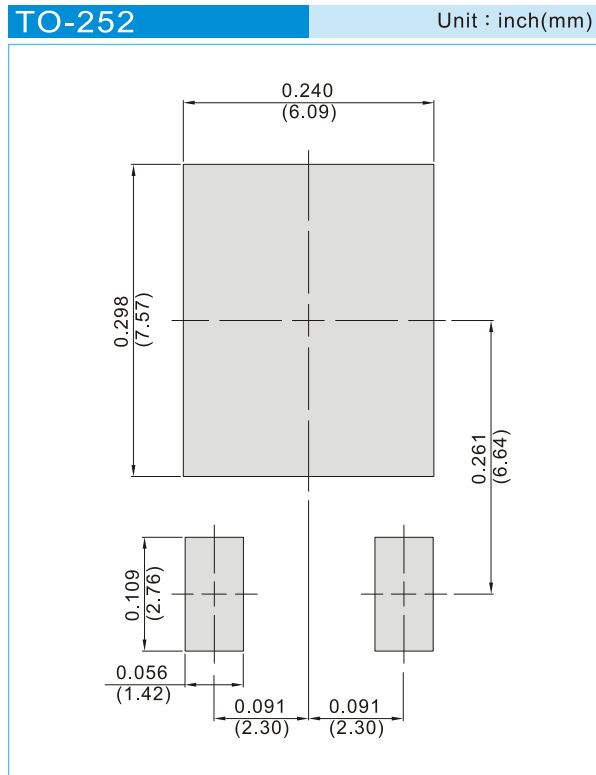

Fig.11 Operating Temperature Derating Curve



BD1040CS~BD10200CS

MOUNTING PAD LAYOUT



ORDER INFORMATION

- Packing information
T/R – 3K per 13" plastic Reel



BD1040CS~BD10200CS

Part No_packing code_Version

BD1040CS_L2_00001

BD1040CS_S2_00001

For example :

RB500V-40_R2_00001

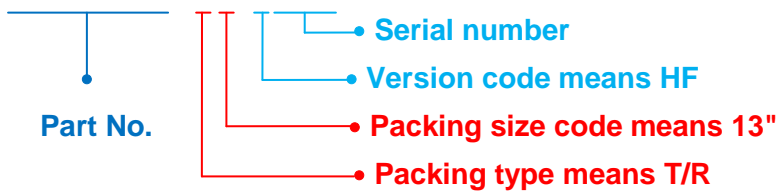

Packing Code XX				Version Code XXXXX		
Packing type	1 st Code	Packing size code	2 nd Code	HF or RoHS	1 st Code	2 nd ~5 th Code
Tape and Ammunition Box (T/B)	A	N/A	0	HF	0	serial number
Tape and Reel (T/R)	R	7"	1	RoHS	1	serial number
Bulk Packing (B/P)	B	13"	2			
Tube Packing (T/P)	T	26mm	X			
Tape and Reel (Right Oriented) (TRR)	S	52mm	Y			
Tape and Reel (Left Oriented) (TRL)	L	PANASERT T/B CATHODE UP (PBCU)	U			
FORMING	F	PANASERT T/B CATHODE DOWN (PBCD)	D			