

## Complementary power Darlingtons

### Features

- Good  $h_{FE}$  linearity
- High  $f_T$  frequency
- Monolithic Darlingtons configuration with integrated antiparallel collector-emitter diode

### Applications

- Linear and switching industrial equipment

### Description

The devices are manufactured in planar base island technology with monolithic Darlingtons configuration.

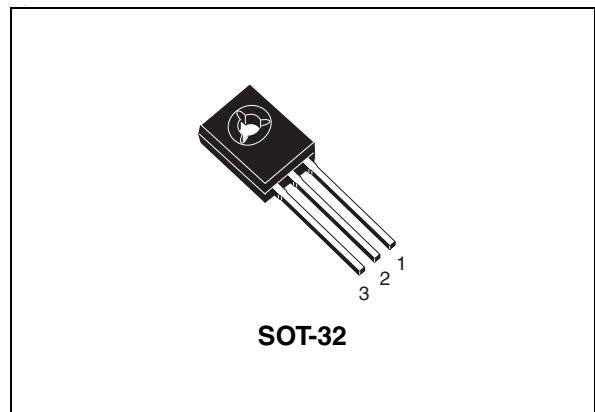

**Figure 1. Internal schematic diagram**

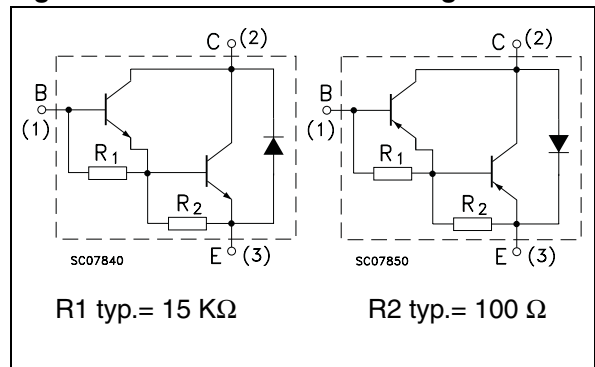

**Table 1. Device summary**

Order codes	Marking	Package	Packaging
BD677	BD677	SOT-32	Tube
BD677A	BD677A		
BD678	BD678		
BD678A	BD678A		
BD679	BD679		
BD679A	BD679A		
BD680	BD680		
BD680A	BD680A		
BD681	BD681		
BD682	BD682		

# Contents

<b>1</b>	<b>Absolute maximum ratings</b> .....	<b>3</b>
<b>2</b>	<b>Electrical characteristics</b> .....	<b>4</b>
2.1	Typical characteristic (curves) .....	6
2.2	Test circuit .....	8
<b>3</b>	<b>Package mechanical data</b> .....	<b>9</b>
<b>4</b>	<b>Revision history</b> .....	<b>11</b>

# 1 Absolute maximum ratings

**Table 2. Absolute maximum ratings**

Symbol	Parameter	Value			Unit	
		NPN	BD677 BD677A	BD679 BD679A		BD681
		PNP	BD678 BD678A	BD680 BD680A		BD682
$V_{CBO}$	Collector-base voltage ( $I_E = 0$ )	60	80	100	V	
$V_{CEO}$	Collector-emitter voltage ( $I_B = 0$ )					
$V_{EBO}$	Emitte-base voltage ( $I_C = 0$ )	5			V	
$I_C$	Collector current	4			A	
$I_{CM}$	Collector peak current	6			A	
$I_B$	Base current	0.1			A	
$P_{TOT}$	Total dissipation at $T_{case} = 25^\circ\text{C}$	40			W	
$T_{stg}$	Storage temperature	-65 to 150			$^\circ\text{C}$	
$T_J$	Max. operating junction temperature	150			$^\circ\text{C}$	

*Note:* For PNP types voltage and current values are negative

## 2 Electrical characteristics

( $T_{case} = 25^{\circ}C$ ; unless otherwise specified)

**Table 3. Electrical characteristics**

Symbol	Parameter	Test conditions	Min.	Typ.	Max.	Unit
$I_{CEO}$	Collector cut-off current ( $I_B = 0$ )	$V_{CE} = \text{half rated } V_{CEO}$			0.5	mA
$I_{CBO}$	Collector cut-off current ( $I_E = 0$ )	$V_{CE} = \text{rated } V_{CBO}$ $V_{CE} = \text{rated } V_{CBO}$ $T_C = 100^{\circ}C$			0.2 2	mA
$I_{EBO}$	Emitter cut-off current ( $I_C = 0$ )	$V_{EB} = 5 V$			2	mA
$V_{CEO(sus)}^{(1)}$	Collector-emitter sustaining voltage ( $I_B = 0$ )	for BD677, BD677A, BD678, BD678A $I_C = 50 \text{ mA}$	60			V
		for BD679, BD679A, BD680, BD680A $I_C = 50 \text{ mA}$	80			
		for BD681, BD682 $I_C = 50 \text{ mA}$	100			
$V_{CE(sat)}^{(1)}$	Collector-emitter saturation voltage	for BD677, BD678, BD679, BD680, BD681, BD682 $I_C = 1.5 \text{ A}$ $I_B = 30 \text{ mA}$			2.5	V
		for BD677A, BD678A, BD679A, BD680A $I_C = 2 \text{ A}$ $I_B = 40 \text{ mA}$			2.8	
$V_{BE}^{(1)}$	Base-emitter voltage	for BD677, BD678, BD679, BD680, BD681, BD682 $I_C = 1.5 \text{ A}$ $V_{CE} = 3 \text{ V}$			2.5	V
		for BD677A, BD678A, BD679A, BD680A $I_C = 2 \text{ A}$ $V_{CE} = 3 \text{ V}$				

Table 3. Electrical characteristics (continued)

Symbol	Parameter	Test conditions	Min.	Typ.	Max.	Unit
$h_{FE}^{(1)}$	DC current gain	for BD677, BD678, BD679, BD680, BD681, BD682 $I_C = 1.5 \text{ A}$ $V_{CE} = 3 \text{ V}$	750			
		for BD677A, BD678A, BD679A, BD680A $I_C = 2 \text{ A}$ $V_{CE} = 3 \text{ V}$				

1. Pulsed duration = 300 ms, duty cycle  $\geq 1.5\%$ .

*Note:* For PNP types voltage e current values are negative.

## 2.1 Typical characteristic (curves)

Figure 2. DC current gain (NPN)

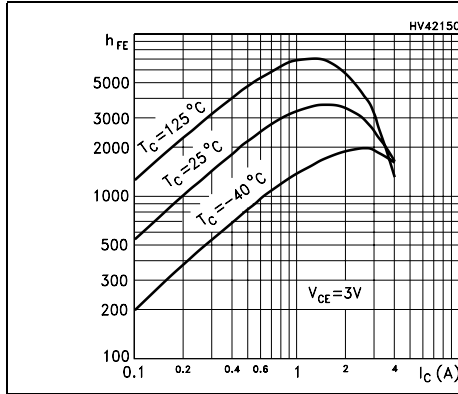

Figure 3. DC current gain (PNP)

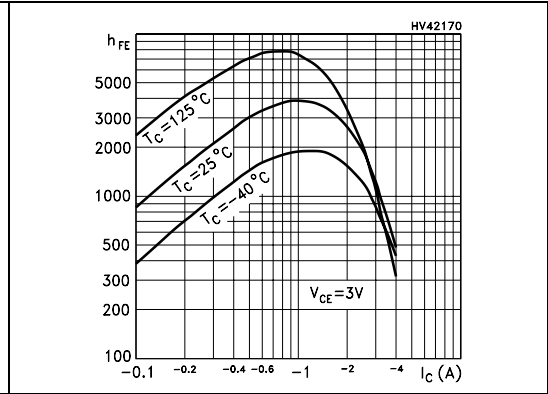

Figure 4. DC current gain (NPN)

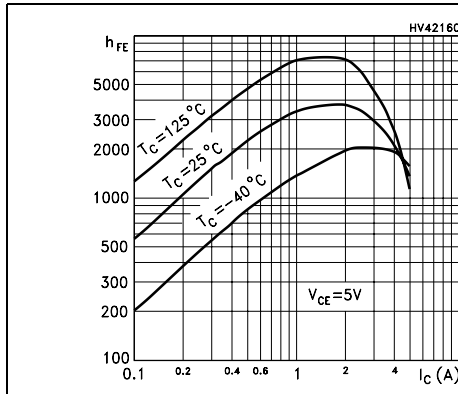

Figure 5. DC current gain (PNP)

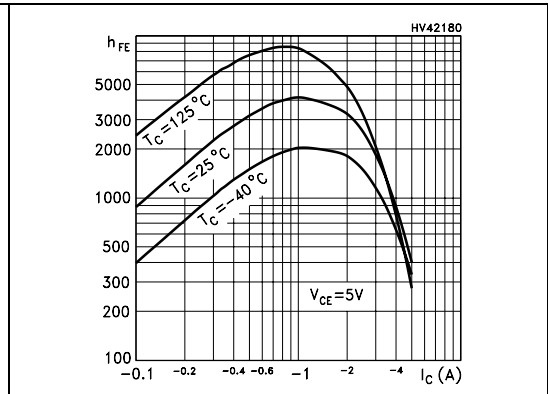

Figure 6. Collector-emitter saturation voltage (NPN)

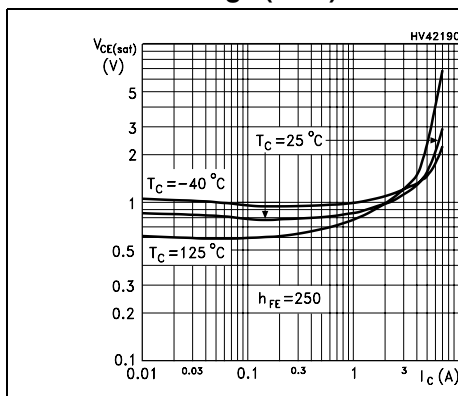
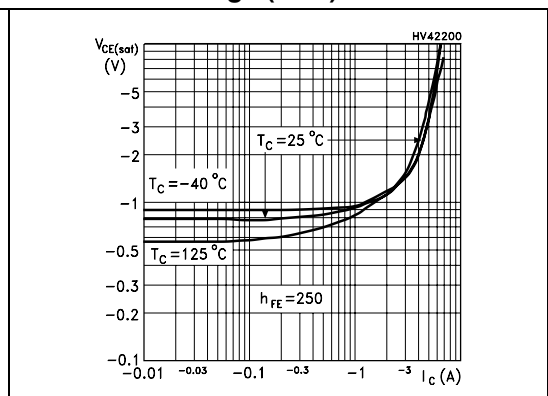
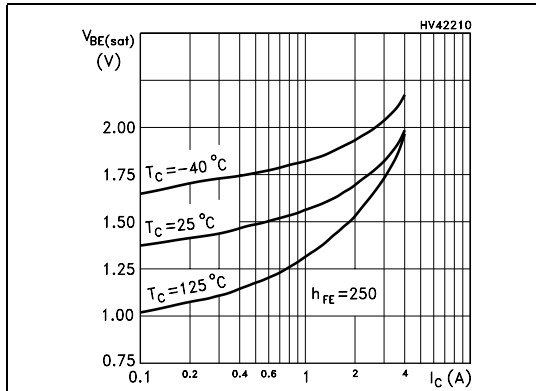

Figure 7. Collector-emitter saturation voltage (PNP)



**Figure 8. Base-emitter saturation voltage (NPN)**



**Figure 9. Base-emitter saturation voltage (PNP)**

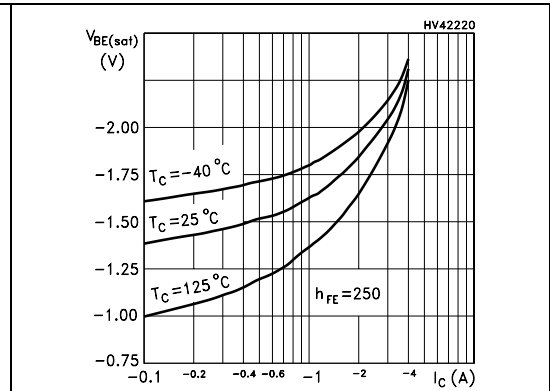

**Figure 10. Base-emitter voltage (NPN)**

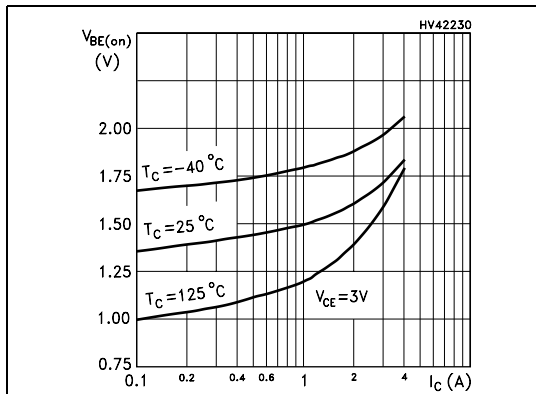

**Figure 11. Base-emitter voltage (PNP)**

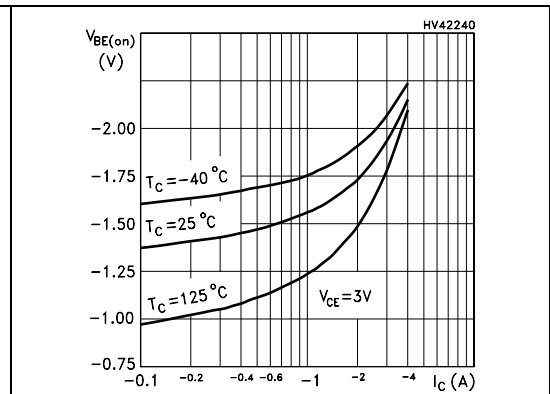

**Figure 12. Resistive load switching time (NPN, on)**

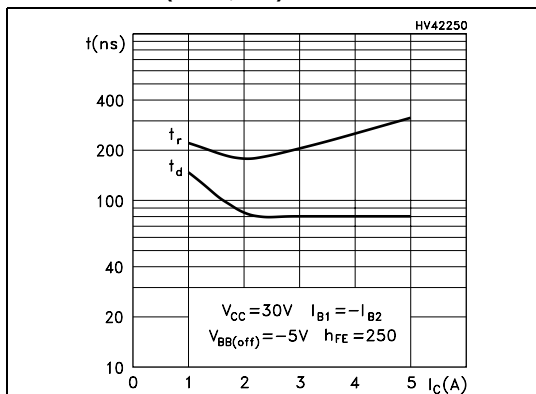

**Figure 13. Resistive load switching time (PNP, on)**

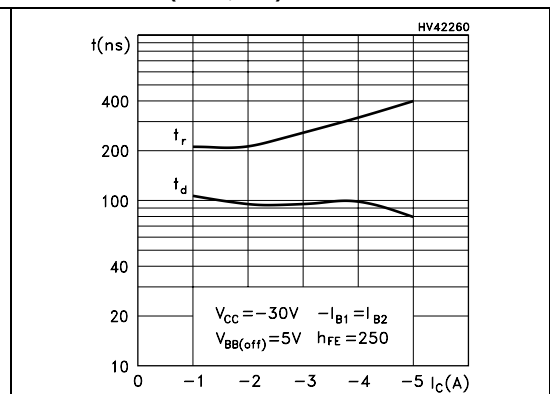

**Figure 14. Resistive load switching time (NPN, off)**      **Figure 15. Resistive load switching time (PNP, off)**



## 2.2 Test circuit

**Figure 16. Resistive load switching test circuit**



*Note: For PNP types voltage e current values are negative.*



### 3 Package mechanical data

In order to meet environmental requirements, ST offers these devices in ECOPACK® packages. These packages have a lead-free second level interconnect . The category of second level interconnect is marked on the package and on the inner box label, in compliance with JEDEC Standard JESD97. The maximum ratings related to soldering conditions are also marked on the inner box label. ECOPACK is an ST trademark. ECOPACK specifications are available at: [www.st.com](http://www.st.com)

**SOT-32 (TO-126) MECHANICAL DATA**

DIM.	mm.		
	MIN.	TYP	MAX.
A	2.4		2.9
B	0.64		0.88
B1	0.39		0.63
D	10.5		11.05
E	7.4		7.8
e	2.04	2.29	2.54
e1	4.07	4.58	5.08
L	15.3		16
P	2.9		3.2
Q		3.8	
Q1	1		1.52
H2		2.15	
l		1.27	



## 4 Revision history

**Table 4. Document revision history**

Date	Revision	Changes
21-Jun-2004	4	
14-Jan-2008	5	<ol style="list-style-type: none"><li>1. Technology change from epybase to planar.</li><li>2. Updated <a href="#">Section 2.1: Typical characteristic (curves) on page 6</a></li><li>3. Content reworked to improve readability.</li></ol>