

ROHM Battery Charger Solutions

BD99954MWV Evaluation Kit

Contents

Item No.	Topic	Page No.
1	Introduction	2
1.2	Description	2
1.3	Applications	2
1.4	Features	2
2	Evaluation Board Operating Limits and Absolute Maximum Ratings	2
3	Power Up Procedure	2
3.1	Evaluation Kit Description	3
4	BD99954 GUI Installation	4
4.1	BD99954 GUI Uninstall	10
5	Miscellaneous Controls and Menus	11
5.1	Slave Address Indicator and Input Box	11
5.2	Write all Button	11
5.3	Device Connectivity Status Indicator	11
5.4	Edit Menu -> Change Device	11
5.5	Help Menu	11
5.6	About	11
6	Battery Charging Profile	12
6.1	Block Diagram of the Set Up for Battery Charging	12
6.2	Procedure and Set Up for Battery Charging	12
7	Additional Topics	16
7.1	Block Diagram of the Set Up for Reverse Buck Boost	16
7.2	Procedure and Set Up for Reverse Buck Boost	16
7.3	1-4 Cell Selection	17
7.4	Input Current Limit Upon Power Up	17
7.5	BC1.2 Detection	17
8	BD99954 Schematic	19
8.1	USB-to-I2C Schematic	20
9	Board Layout	20
9.1	Top View	20
9.2	GND Inner Layer1	21
9.3	PWR Inner Layer2	21
9.4	Bottom Layer	22
10	Bill of Materials	22
10.1	Bill of Materials: USB-to-I2C Schematic	23

ROHM Battery Charger Solutions

BD99954MWW Evaluation Kit

1 Introduction

This application note provides information on the BD99954MWW EVK board, which includes the bill of materials, schematics, board layout, and application data. In addition to this, a user manual for the I2C control software is included to help program the BD99954MWW.

1.1 Description

The BD99954MWW EVK acts as a platform for the BD99954 battery management LSI. With the included software GUI, users can access the battery charging profile and modify and read back the registers of the BD99954.

1.2 Applications

1-4 Li-ion Cells (in series) Battery Charging

1.3 Features

Reverse Buck/Boost Option

On-Board USB-to-I2C Communication Circuit

Input Operating Range: 3.8V to 25V

2 Evaluation Board Operating Limits and Absolute Maximum Ratings

	MIN	MAX	UNIT
Input Voltage - VBUS	3.8	25	V
Input Voltage - VCC	3.8	25	V
Output Voltage - VSYS	2.56	19.2	V
Output Voltage - VBATT	0	19.2	V
Input Current - IIN	-	16	A
System Current - ISYS	-	16	A
Battery Charging Current - ICHARGE	-	16	A

Table 1. BD99954 EVK Limits and Absolute Max. Ratings

3 Power up Procedure

1. Attach power supply to VBUS/VCC banana jacks. BD99954 will detect which node is being used to power up IC, but if both VBUS and VCC (Figure 1) are connected to a source, VBUS will have priority to power up IC unless programmed otherwise.
2. If battery charging is in order, attach cell(s) to the VBATT (Figure 1) banana jacks.
3. Set up power supply voltage to between 3.8V to 25V. Note that on powering up that the default input current limit is set to 512mA by a resistor divider on the board (R5 and R6) (Refer to Schematic pg.12). The ILIM can be modified by changing the IBUS_LIM_SET(Reg 8h) or ICC_LIM_SET(Reg 7h) for VBUS or VCC inputs respectively, through the software.
4. Turn on power supply. Voltage on VSYS (Figure 1) should be around 8.9V. This is the default value that is programmed into the chip upon power up.
5. If user would like to program the registers of the BD99954, connect micro-USB (Figure 1) to the board (J48) to the USB port of a computer, then utilize the BD99954 I2C Control Software. Refer to BD99954 I2C Control Software User Manual for more information.

3.1 Evaluation Kit (EVK) Description

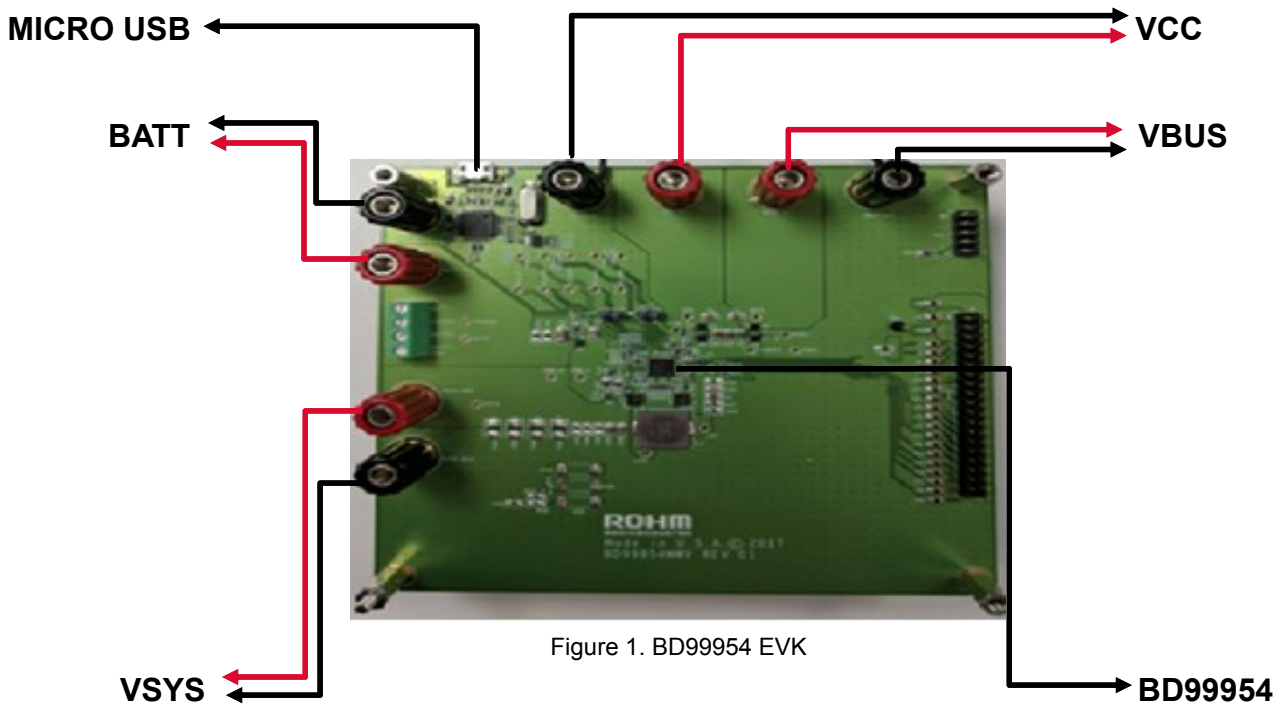

Figure 1. BD99954 EVK

4 BD99954 GUI Installation

1. Make sure PC meets Minimum System Requirements.

Operating System	Windows 7 or Higher
USB Port	USB 2.0 or Higher
Memory	512 MB or Higher
Video Card	512 MB or Higher
Minimum Resolution	At least 1024 x 768
Driver	D2XX

Table 2. System requirements for BD99954 GUI software

2. Download BD99956 I2C Control Setup Wizard from (location). Once downloaded, double-click the executable file to initiate the setup wizard. (Image subject to change)
- 3.

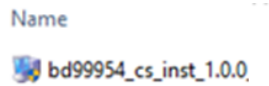

4. Make sure to follow the instructions of the setup wizard. Click "Next" to proceed.

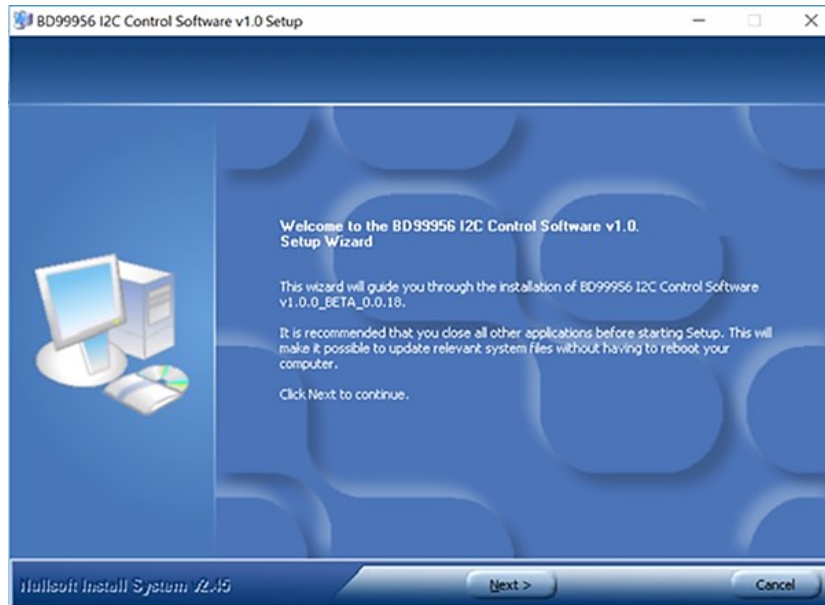

Figure 2. Software Installation Step (1/7)

5. Agree to the Terms and Conditions

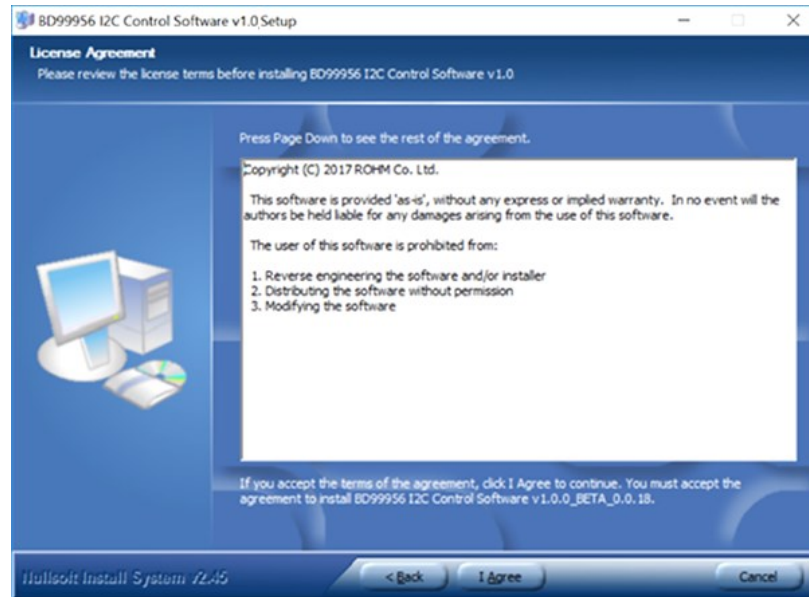

Figure 3. Software Installation Step (2/7)

6. Before installing the program, the default Destination Folder is set to **C:\Program Files(x86)\ROHM_BD99954_Battery_Charger**. Once destination folder is set, click "Install" to begin installation.



Figure 4. Software Installation Step (3/7)

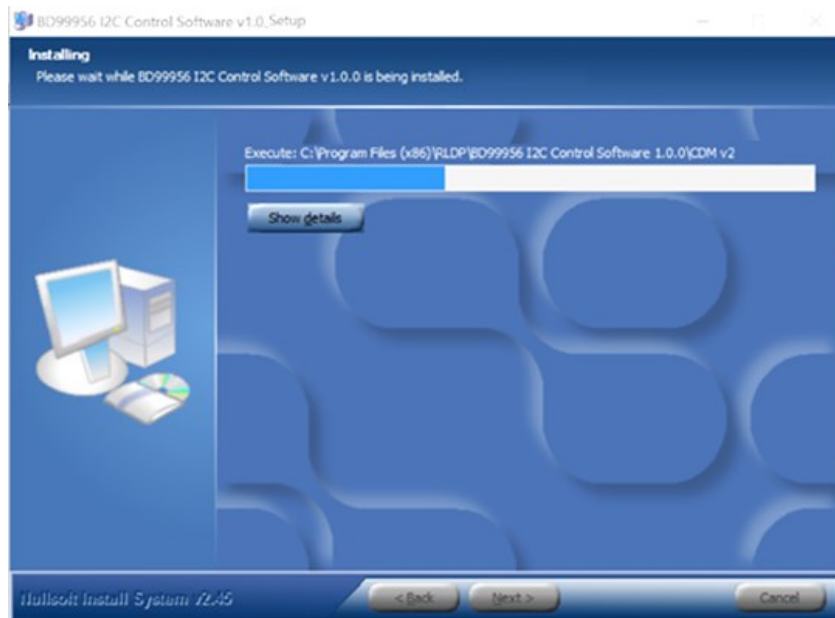

Figure 5. Software Installation Step (4/7)

7. Once base software installation is complete, begin Device Driver Installation Wizard by clicking "Next" and clicking "Extract" to extract and install drivers. Once installation is complete, click "Finish".

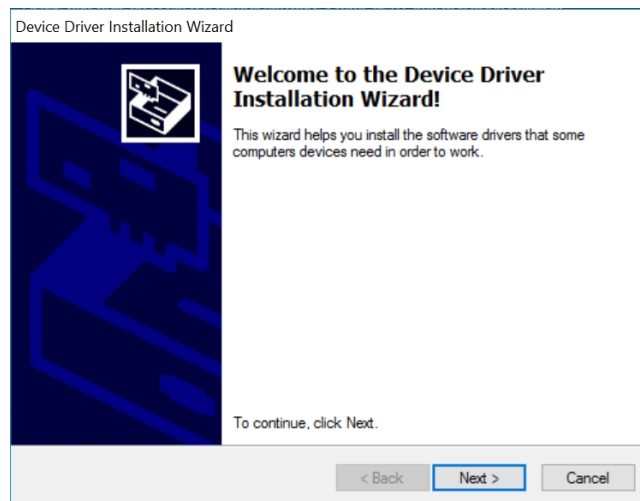

Figure 6. Software Installation Step (5/7)

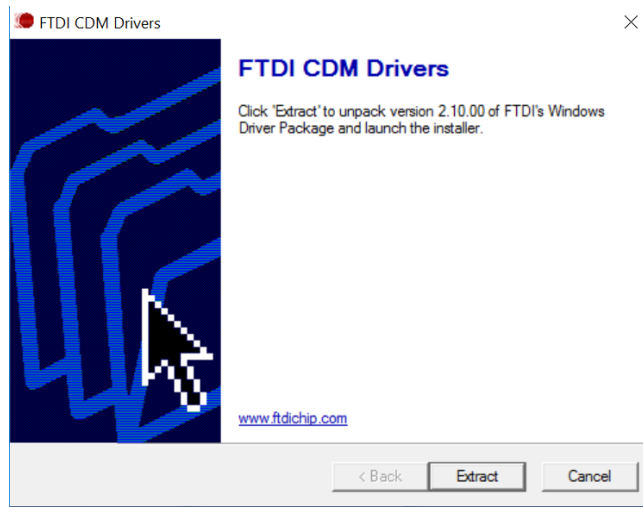

Figure 7. Software Installation Step (6/7)

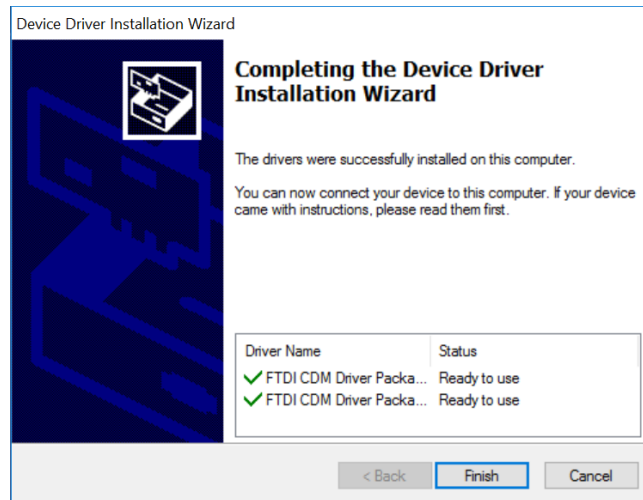

Figure 8. Software Installation Step (7/7)

- Before opening the application, make sure BD99954MWV board is connected to you PC via USB cable and is powered on with a power supply. Once connected, click on the BD99954 I2C Control icon located on your desktop or find the application in the Windows Start Menu to start the program.

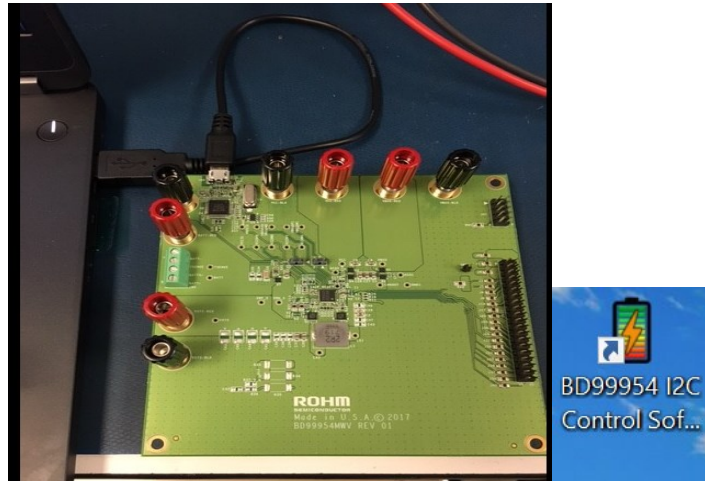

Figure 9. USB-I2C Communication Set Up and Desktop Shortcut

TIP: Make sure BD99954MWV Board has voltage above 3.8V-25V through VBATT, VCC, or VBUS so you won't get this error message.

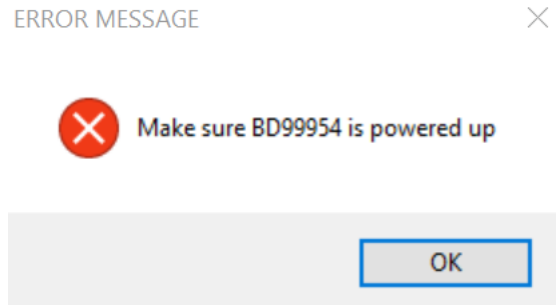

Figure 10. Error Message – No Input Power

TIP: Upon starting the program and BD99954 board is being powered up with the appropriate voltage, the software will indicate on the top-right corner if the board is connected properly.

4.1 BD99954 Uninstall Guide

1. Locate and run "Uninstall" of "BD99954 I2C Control Software v1.0.x" from the start menu.

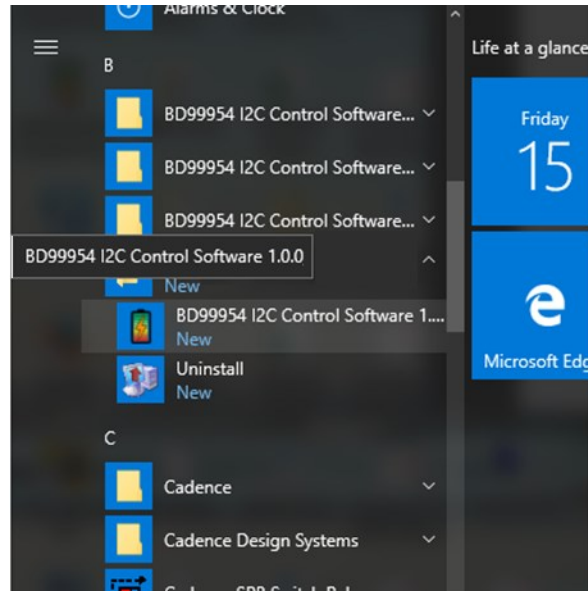

Figure 14. Uninstallation Step (1/2)

2. Click "OK" to completely remove software application, or click "Cancel" to quit.

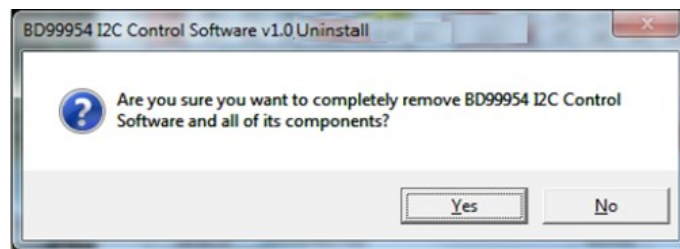

Figure 15. Uninstallation Step (2/2)

5 Miscellaneous Controls and Menus

5.1 Slave Address Indicator and Input Box – Indicates current address of the BD99954MWW EVK Board. It is pre-programmed to address 09h.

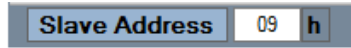

Figure 16. BD99954 Slave Address

5.2 Write all Button – When pressed, software performs a write command to all registers.

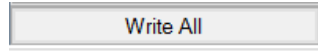

Figure 17. BD99954 Slave Address

5.3 Device Connectivity Status Indicator – Message will read whether BD99954MWW EVK is connected to the PC.



Figure 18. BD99954 EVK Connectivity Status

5.4 Edit Menu -> Change Device – Allows user to change FTDI communication device.

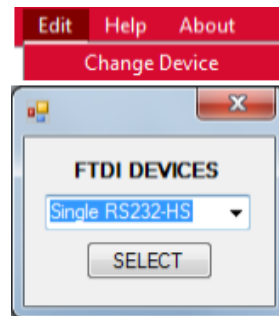

Figure 19. Changing FTDI Device

5.5 Help Menu – Provides resource links to aid in the operation of the BD99954MWW EVK Board/Software, and BD99954 IC.

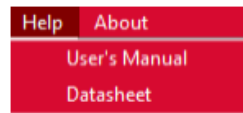

Figure 20. BD99954 GUI Help Menu

5.6 About – Software Developer Information.



Figure 21. BD99954 GUI About Box

6 Battery Charging Profile

The battery charging profile shown in Figure 22 can be seen dynamically on the software GUI which actively tracks the charging status of the charger.

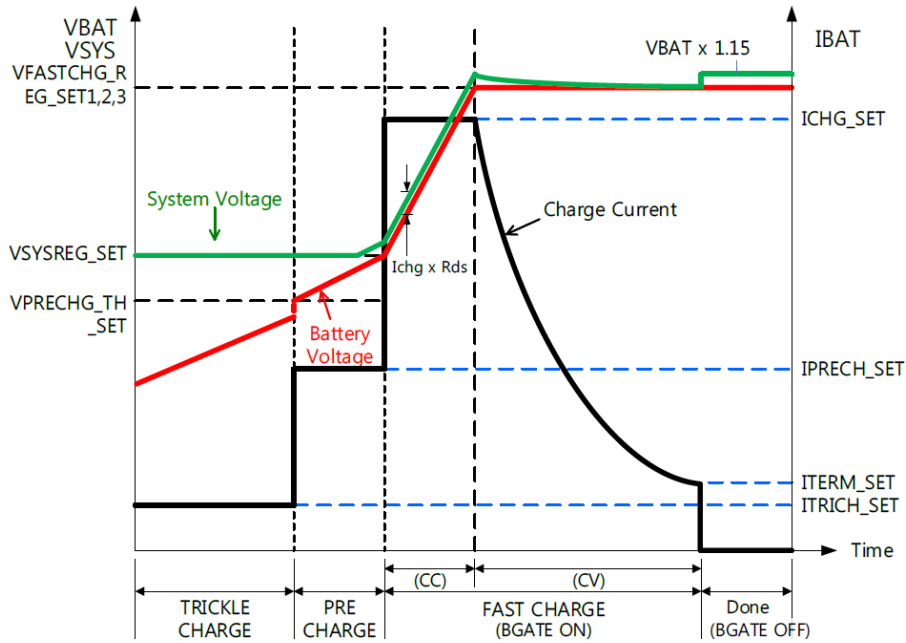

Figure 22. Battery Charging Profile

6.1 Block Diagram of the Set Up for Battery Charging

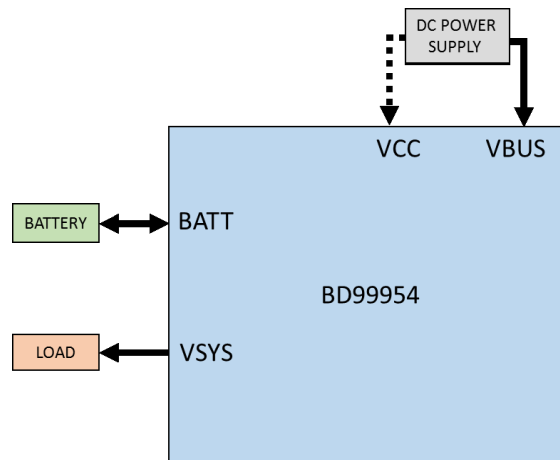

Figure 23. Set Up for Battery Charging

6.2 Procedure and Set Up for Battery Charging

1. Supply the input through VBUS or VCC as shown in Figure 23. Input range is from 3.8V to 25V
2. The OTP register settings for the part is for a 2S system and hence the part will power up with an output VSYS = 8.9V.
3. The default state is battery not charging (set through OTP).
4. The USB-I2C communication is set up by using a USB-micro USB cable as shown in Figure 9.
5. Since the OTP setting is for a 2S system. Please apply battery voltage less than 8.4V (2S = 2*4.2V) if connecting without changing any settings through the GUI.
6. The input current limit is limited by the voltage on the IADP pin and is 512mA upon power up. The required current limit is to

be written to IBUS_LIM_SET(Reg 7h) or ICC_LIM_SET(Reg 8h) depending on the preferred input VBUS or VCC respectively. The input current limit CUR_ILIM_VAL(Reg 5h) will reflect the change. (Refer Figure 24)

7. To trickle charge the battery, connect a battery which is below VPRECHG_TH_SET(Reg 18h) and click on the CHG_EN button on 'Battery Charging Profile'. The battery starts charging with trickle charge current set by ITRICH_SET(Reg 14h) as soon as the CHG_EN button turns green (CHG_EN = 1). The Trickle Charge area of the charging profile in the 'Battery Charging Profile' tab of the GUI should reflect the same. (Refer Figure 24)
8. As the battery gets charged and the battery voltage becomes higher than VPRECHG_TH_SET(Reg 18h), the charging state changes to Pre- Charge with pre charge current set by IPRECH_SET(Reg 15h). The Pre Charge area of the charging profile in the Battery Charging Profile' tab of the GUI should reflect the same. (Refer Figure 24 and 25)
9. Change the VSYSREG_SET(Reg 11h) to the required level at which the battery needs to start fast charging. When the battery voltage is higher than VSYSREG_SET(Reg 11h) the battery starts fast charging with fast charge current set by ICHG_SET(Reg 16h). The Fast Charge(CC) area of the charging profile in the Battery Charging Profile' tab of the GUI should reflect the same. (Refer Figure 24 and 26)
10. When the battery charges up to VFASTCHG_REG_SET1(Reg 18h) which is the max. battery charge level, the charging state changes from Fast Charge CC mode to Fast Charge CV mode and the charge current decays to the termination current set through ITERM_SET(Reg 17h). (Refer Figure 24 and 27)
11. If ITERM_SET(Reg 17h) is non-zero value, as the charge current decays and becomes lower than ITERM_SET(Reg 17h), then the charge state changes to Top-off. This state is not indicated in the charging profile in the 'Battery Charging Profile' tab of the GUI. The charge state remains in the Top-off state for 15s before changing to Done state.
12. In Done state, the battery stops charging and the output voltage VSYS is 15% above the battery voltage. (Refer Figure 28)

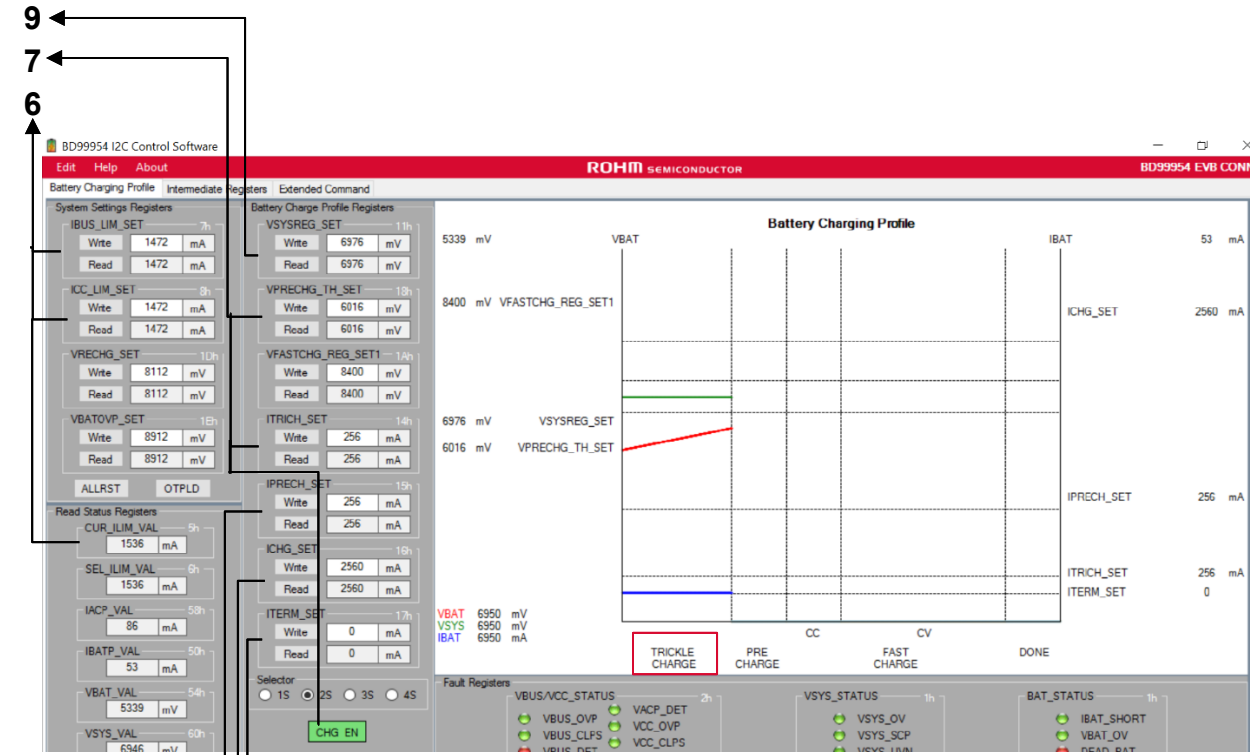

Figure 24. Trickle Charge (Label Numbers Refer to the Battery Charging Steps listed above)

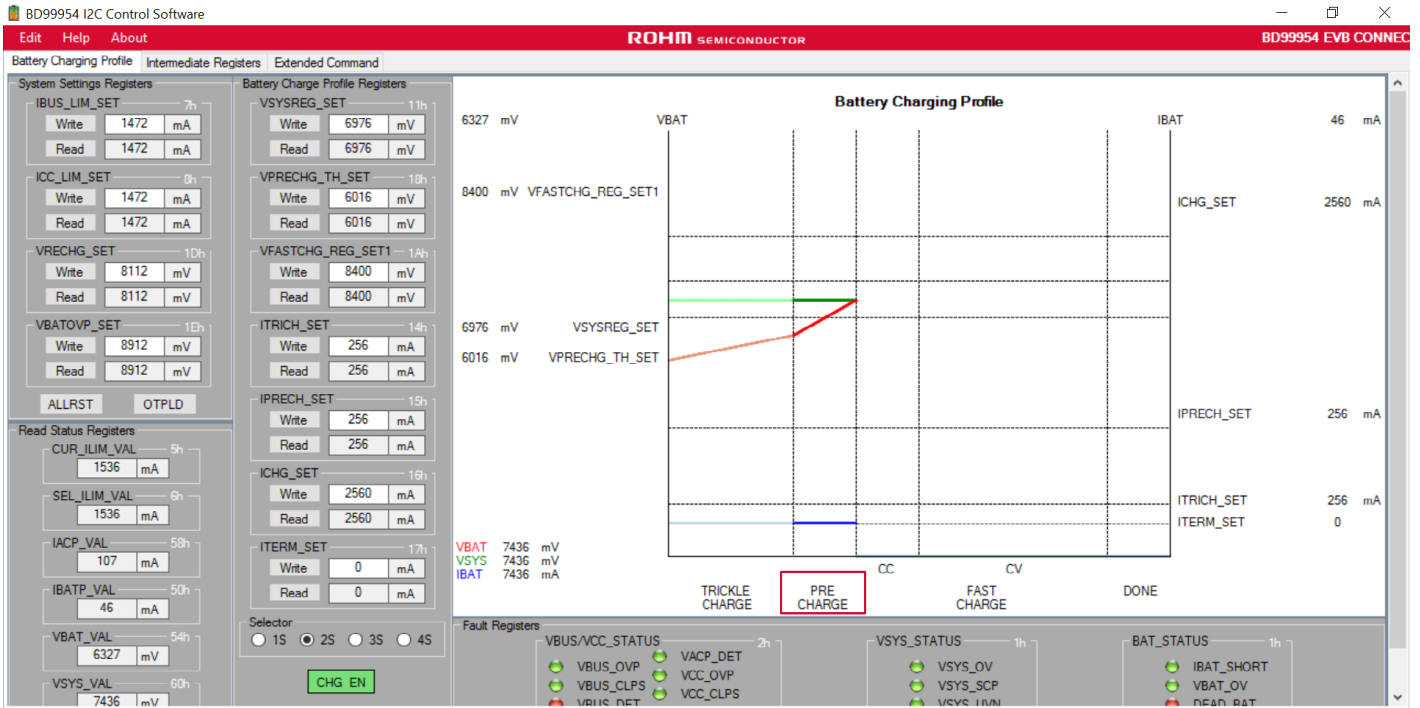

Figure 25. Pre Charge

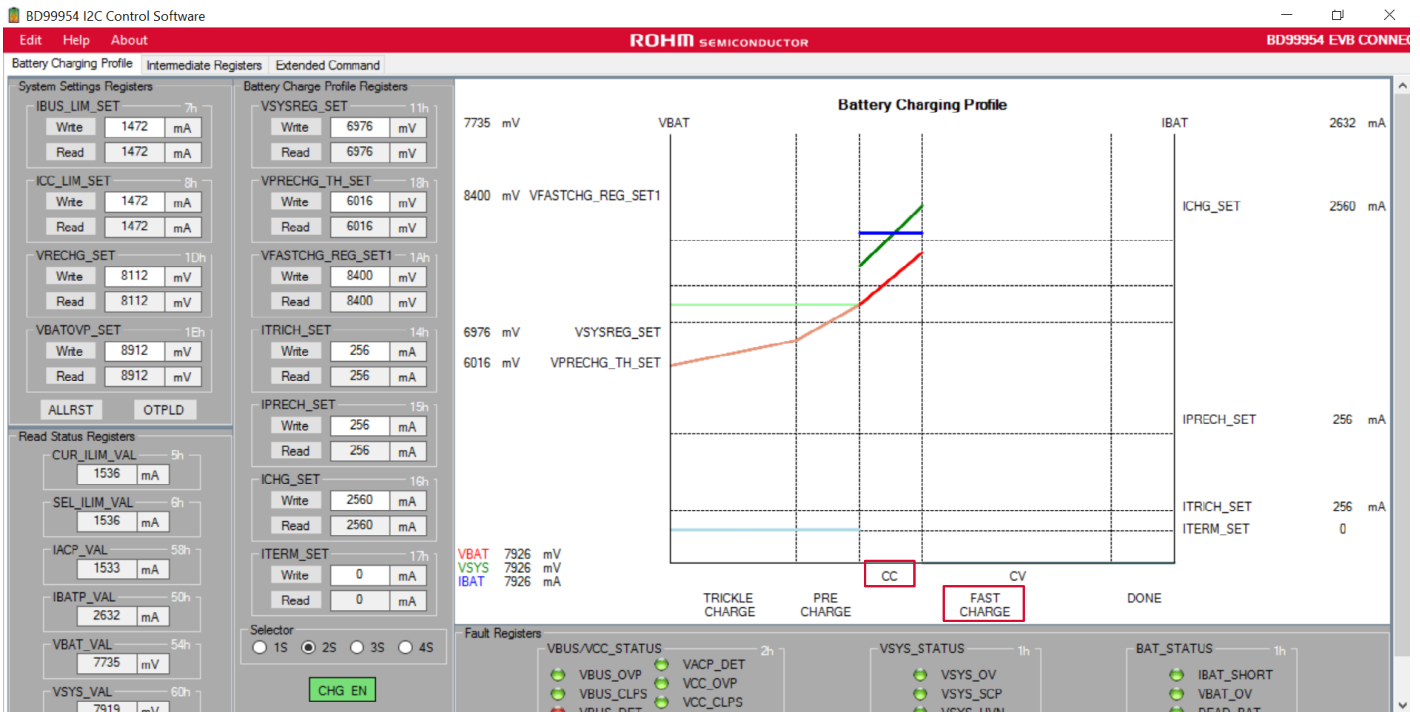

Figure 26. Fast Charge CC

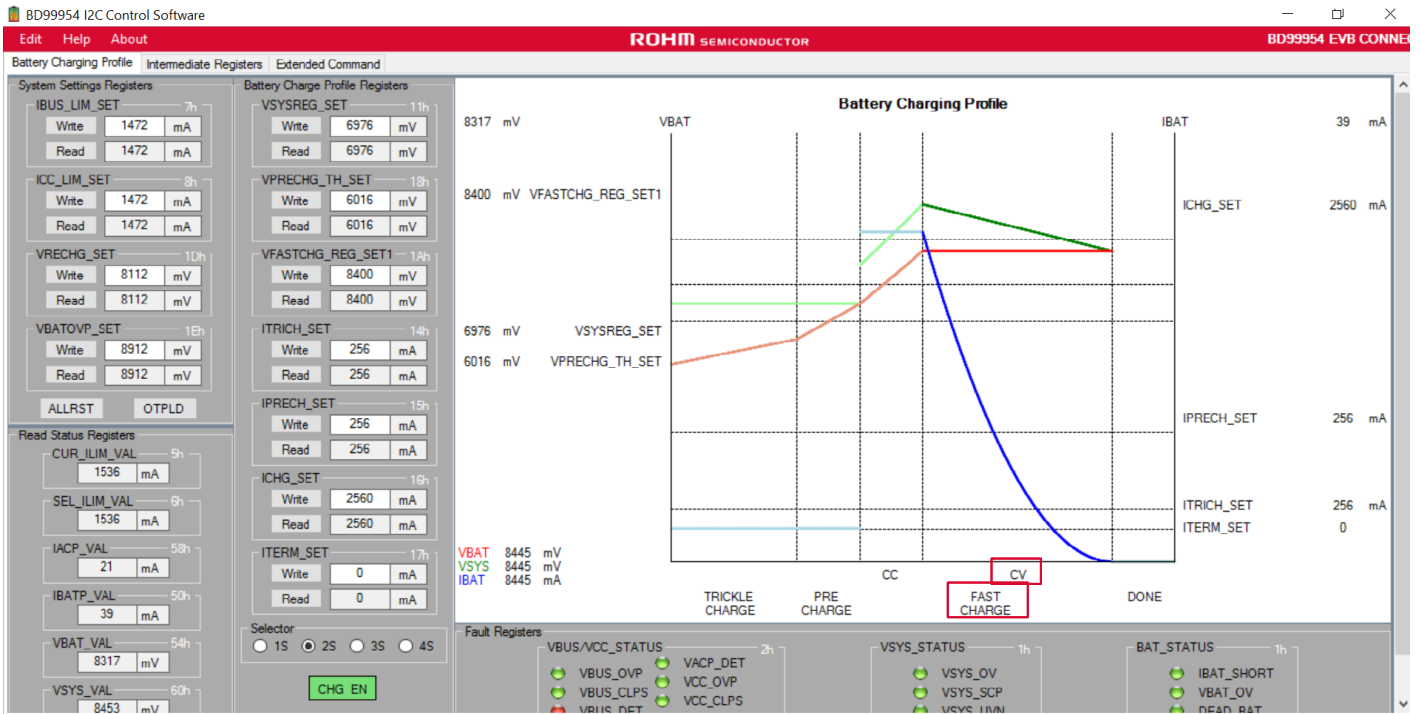

Figure 27. Fast Charge CV

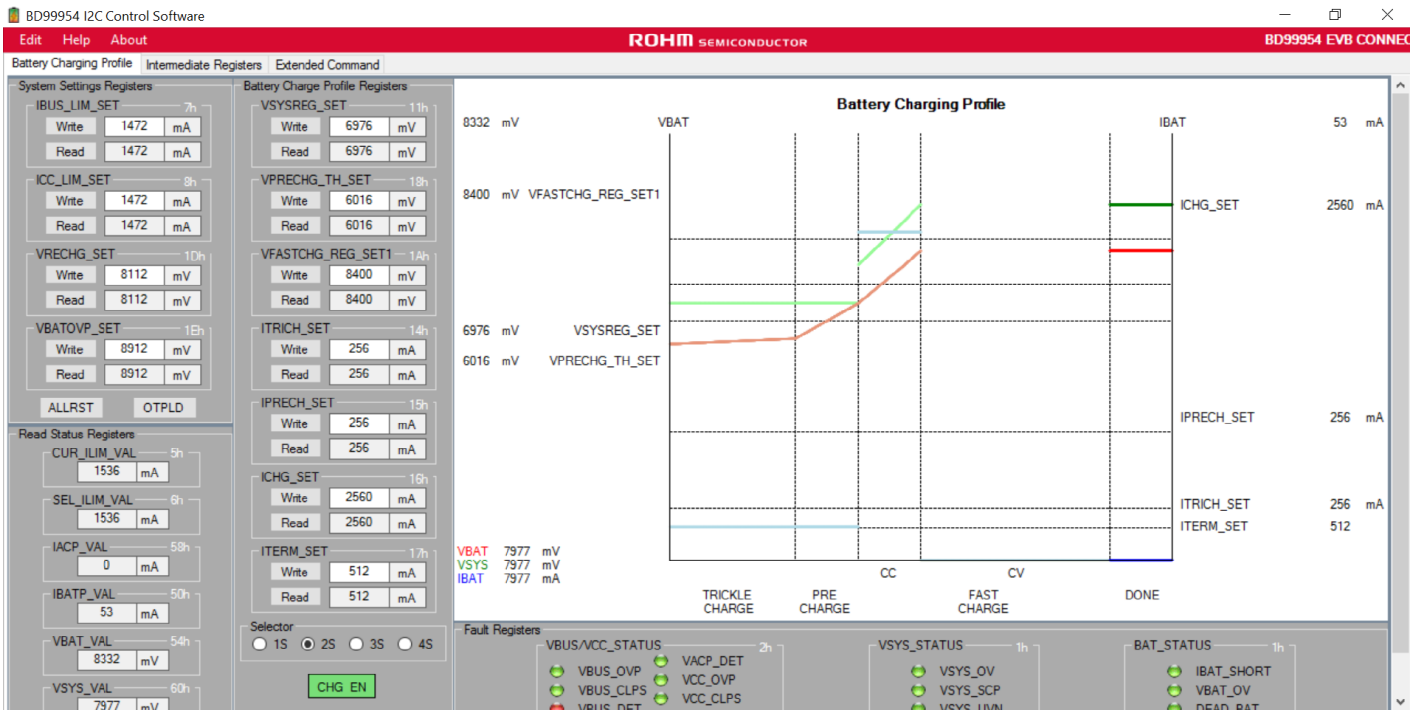

Figure 28. Done

7 Additional Topics

7.1 Block Diagram of the Set Up for Reverse Buck Boost

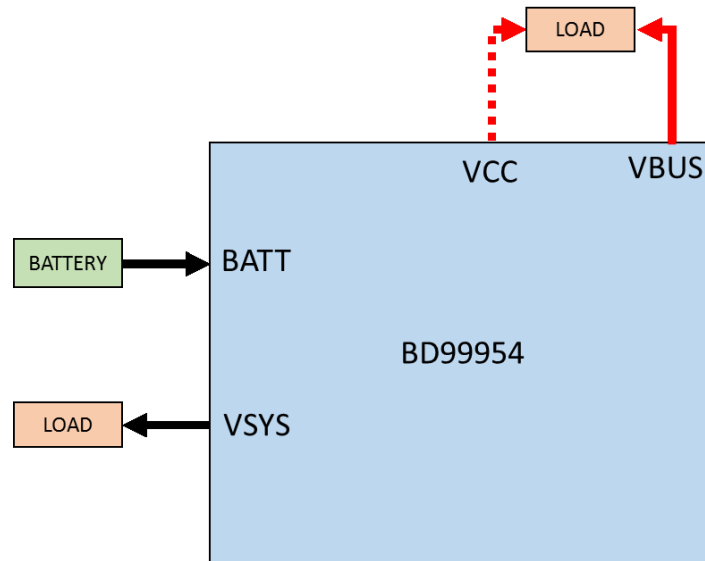
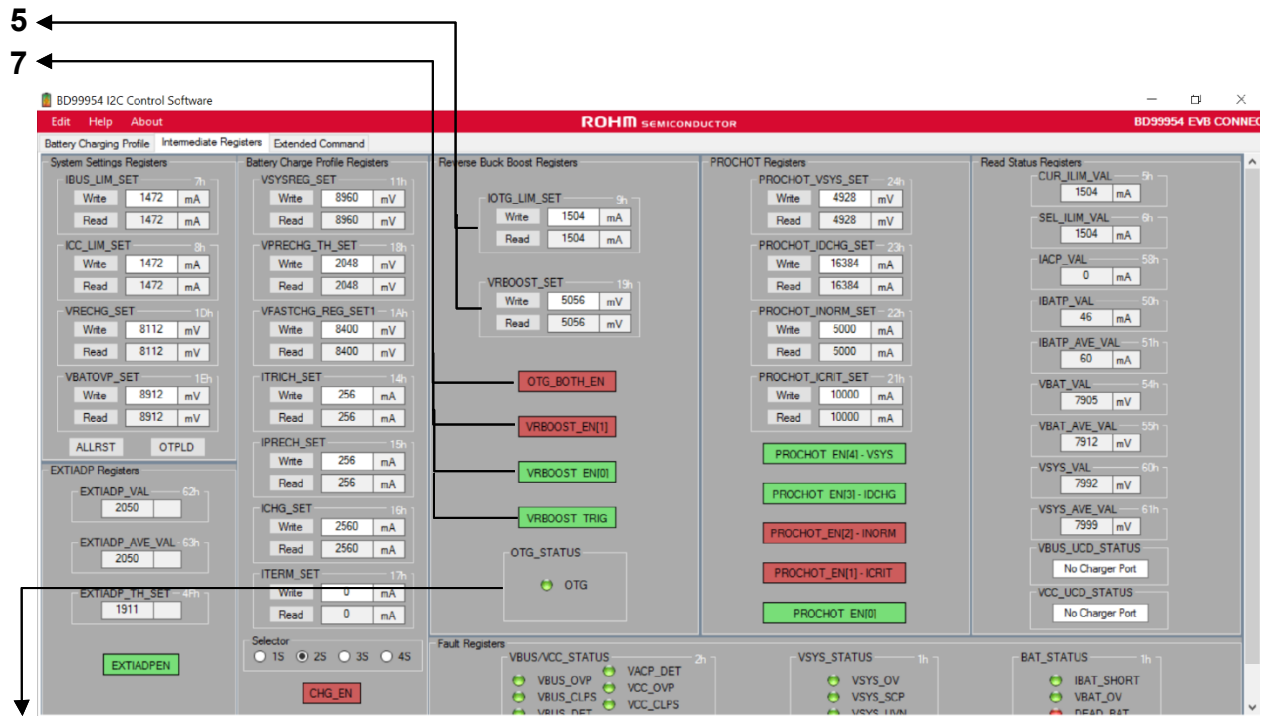

Figure 29. Set Up for Reverse Buck-Boost Operation

7.2 Procedure and Set Up for Reverse Buck Boost

1. Supply the input through battery at BATT as shown in Figure 29. Battery voltage 4S max, equal to 19.2V.
2. The output voltage VSYS will come up to the battery voltage.
3. The USB-I2C communication is set up by using a USB-micro USB cable as shown in Figure 9.
4. Since the OTP setting is not for reverse buck-boost condition, use 'Intermediate Registers' tab to set the registers for the reverse buck-boost condition.
5. The default voltage through OTP is 5V. It can be set through VRBOOST_SET (Reg 19h) and the current is 1.5A set through IOTG_LIM_SET(Reg 9h). (Refer Figure 30)
6. While using reverse buck-boost mode, care should be taken not to connect an input at VBUS/VCC. Set up the 'load' at the required input VBUS/VCC as shown in Figure 29.
7. Select the required input VBUS/VCC by clicking VRBOOST_EN[0]/VRBOOST_EN[1] respectively on the 'Intermediate Registers' tab. If both inputs are preferred then OTG_BOTH_EN is selected. (Refer Figure 30)
8. The reverse buck boost operation is triggered by clicking VRBOOST_TRIG button on the 'Intermediate Registers' tab. The voltage set by VRBOOST_SET (Reg 19h) with the current limit set by IOTG_LIM_SET(Reg 9h) can be observed at the selected input VBUS/VCC.
9. The OTG indicator on the 'Intermediate Registers' tab turns green after the reverse buck-boost operation is started. (Refer Figure 30)



9 Figure 30. Set Up for Reverse Buck-Boost Operation (Label Numbers Refer to the Reverse Buck Boost Steps listed above)

7.3 1-4 Cell Selection

The default OTP settings for BD99954 is 2S (2 cells in series). Cell selections need to be changed when 1S,3S and 4S operations are to be used. When the selections are made, typical register setting values are changed accordingly. Further changes can be made if necessary by using the GUI.

Before changing to 1S mode, both the battery voltage (BATT) and the system output (VSYS) needs to be below 5V. The system output VSYS can be changed by changing the register VSYSREG_SET(Reg 11h). If VSYS or BATT voltage is greater than 5V when 1S mode is selected, it could damage the part.

7.4 Input Current Limit Upon Power Up

The input current limit for BD99954 upon power up is based on the voltage on the IADP pin. On the EVK it is limited to 512mA on power up. Writing to IBUS_LIM_SET(Reg 7h) or ICC_LIM_SET(Reg 8h) whichever is relevant rewrites the current limit under normal circumstances.

If external IADP is disabled by clicking the EXTIADPEN button on the 'Intermediate Registers' tab of the GUI, then the charger no longer powers up with the input current limit based on the voltage at the IADP pin. External IADP disable causes the charger to power up with a current limit of default 128mA.

The input current limit upon power up can be changed by changing the voltage on the IADP pin. The resistor divider R5 and R6 of the schematic can be altered to change the input current limit on power up as per the Figure 30 below.

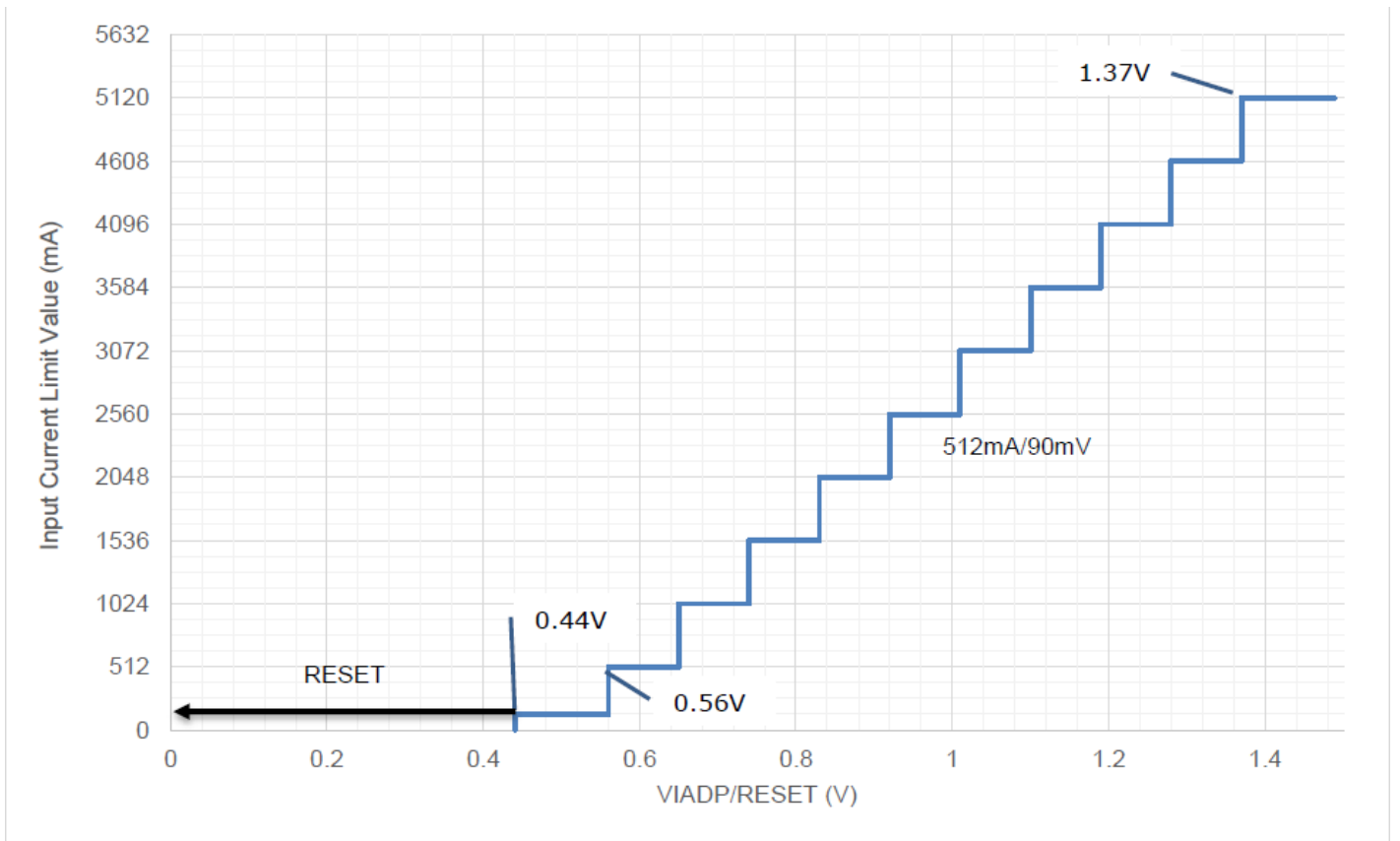

Figure 31. IADP Pin Input Current Limit Settings

7.5 BC1.2 Detection

The BD99954 battery charger is compatible with BC1.2. The DPI and DMI for VCC and VBUS that are shown in the schematic need to be connected if BC1.2 detection is desired. The connection is as shown in Figure 32. When the VBUS/VCC is plugged in, BD99954 asserts ACOK and starts the BC1.2 detection sequence. After the BC1.2 detection is completed, BD99954 limits the input current and reflects the BC1.2 status on VCC_UCD_Status(Reg 29h) and VBUS_UCD_Status(Reg 31h) depending on the settings on VCC_UCD_Set(Reg 28h) and VBUS_UCD_Set(Reg 30h) for VCC and VBUS respectively.

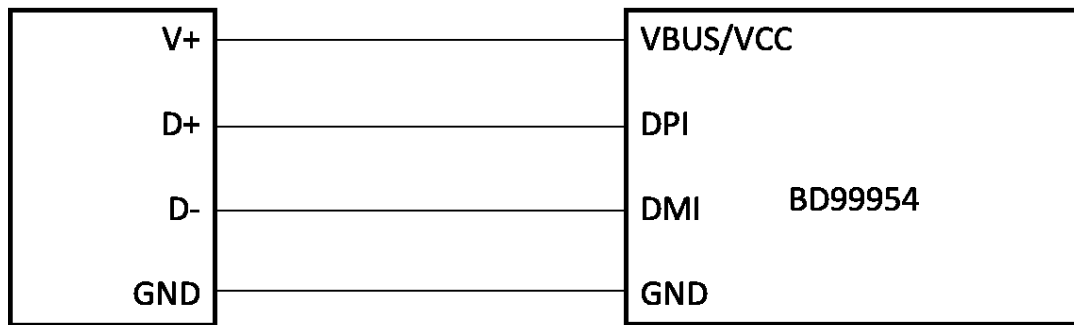

Figure 32. Connection for BC1.2 Detection

8 BD99954 Schematic

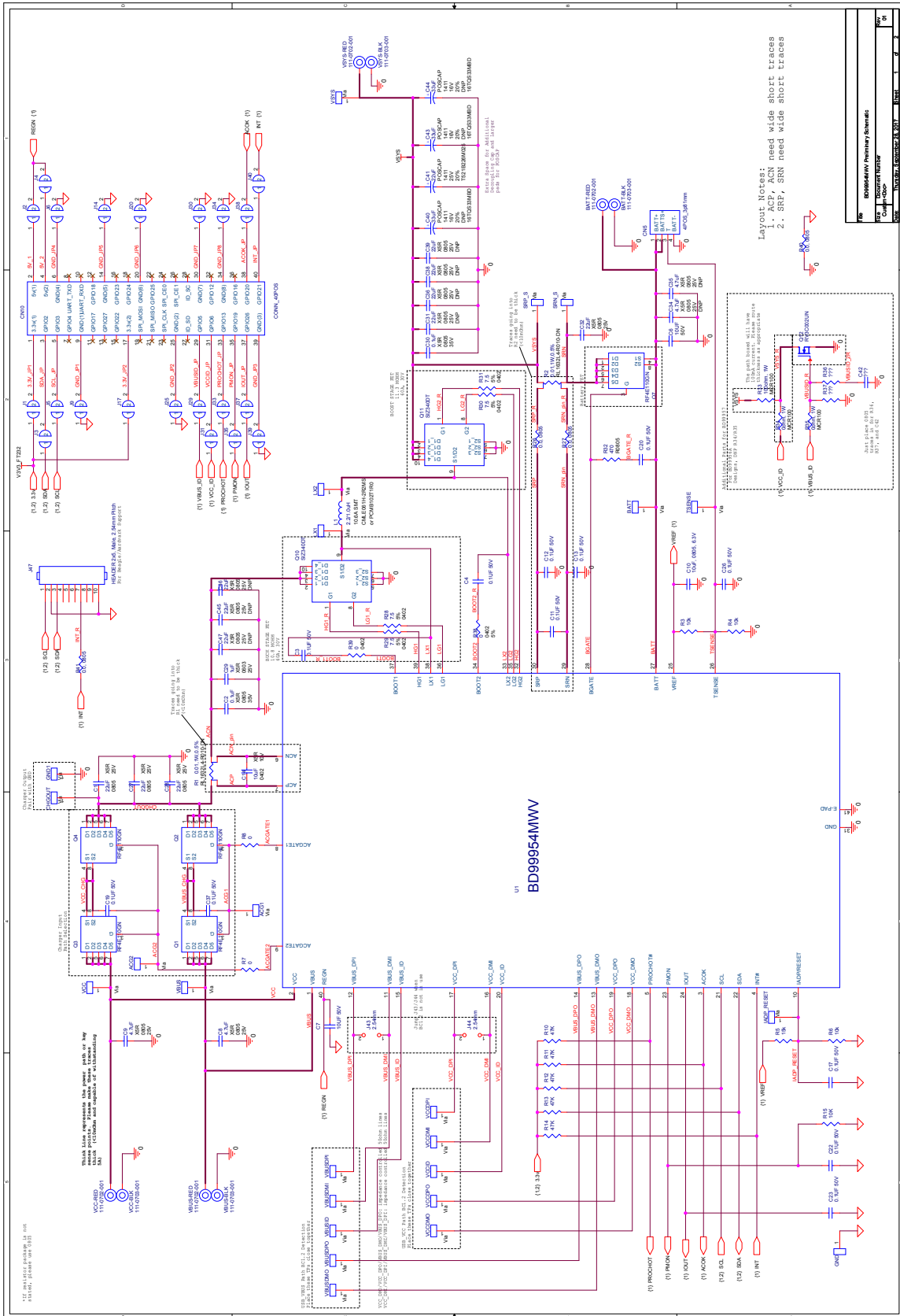

Figure 33. BD99954 Reference Schematic

8.1 USB-to-I2C Schematic

This part of the schematic is included in the EVK for the USB to I²C communication and are not required to be included in the reference design.

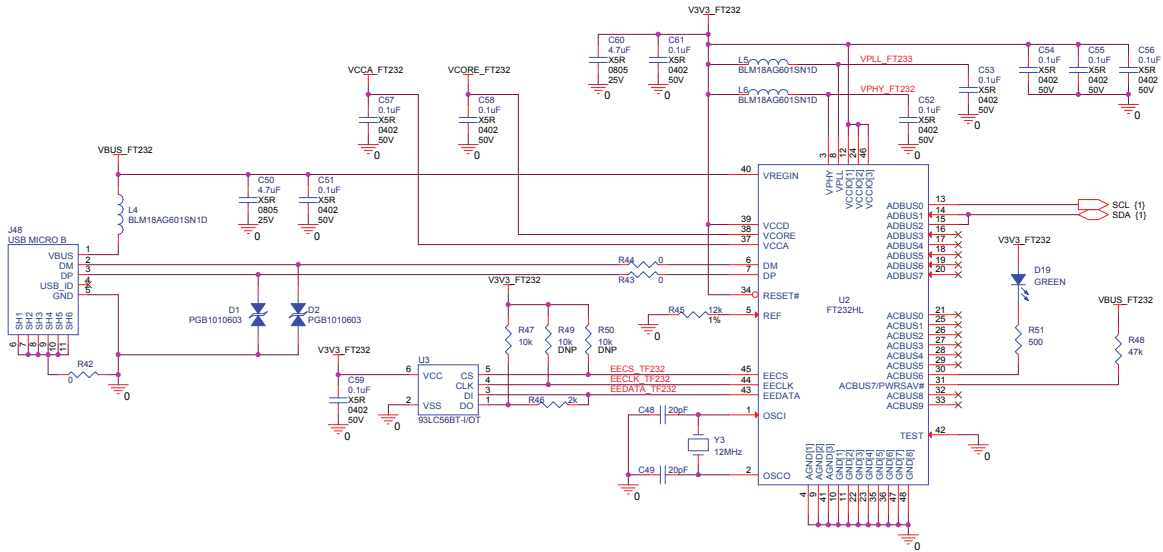

Figure 34. USB to I²C Schematic

9 Board Layout

9.1 Top View

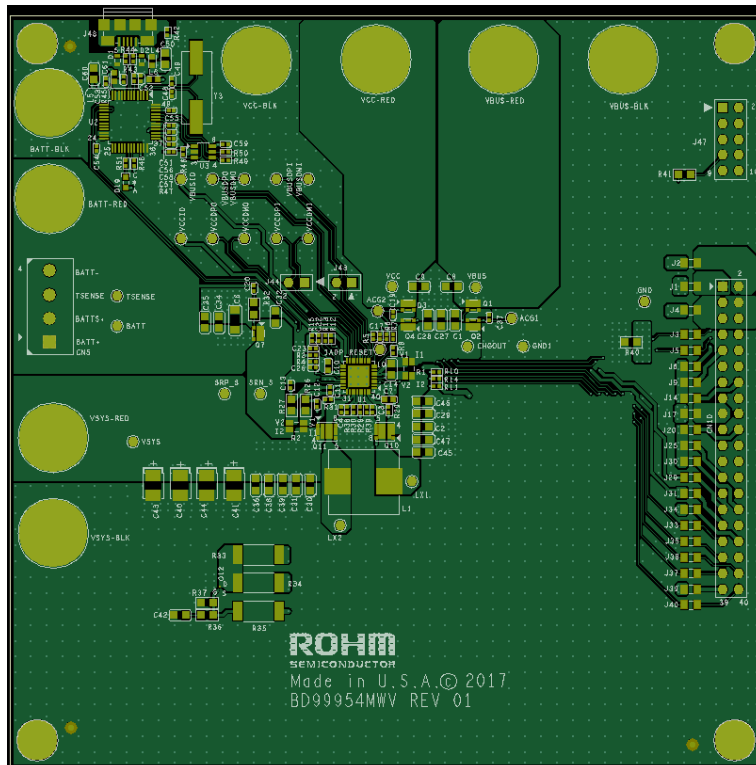

Figure 34. BD99954 EVK Top Layer

9.2 GND Inner Layer1

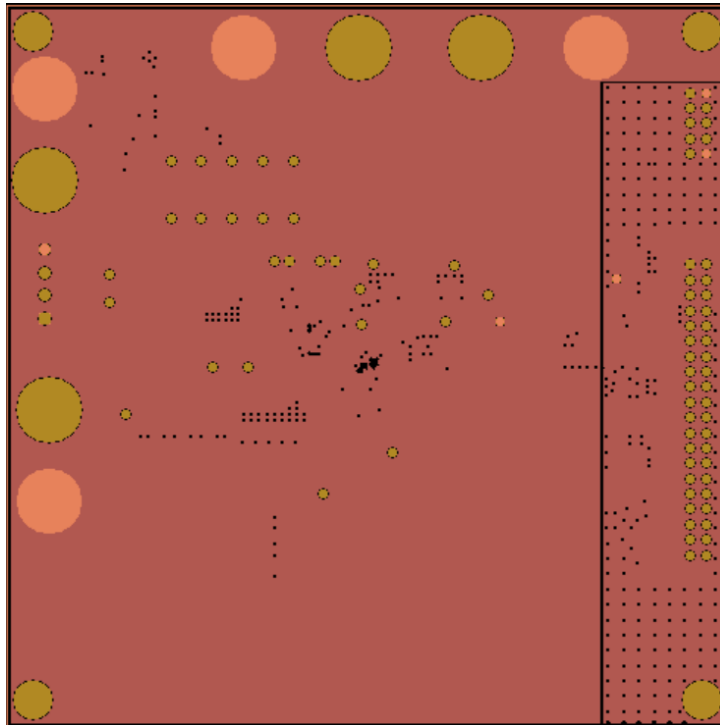

Figure 35. BD99954 EVK GND Inner Layer1

9.3 PWR Inner Layer2

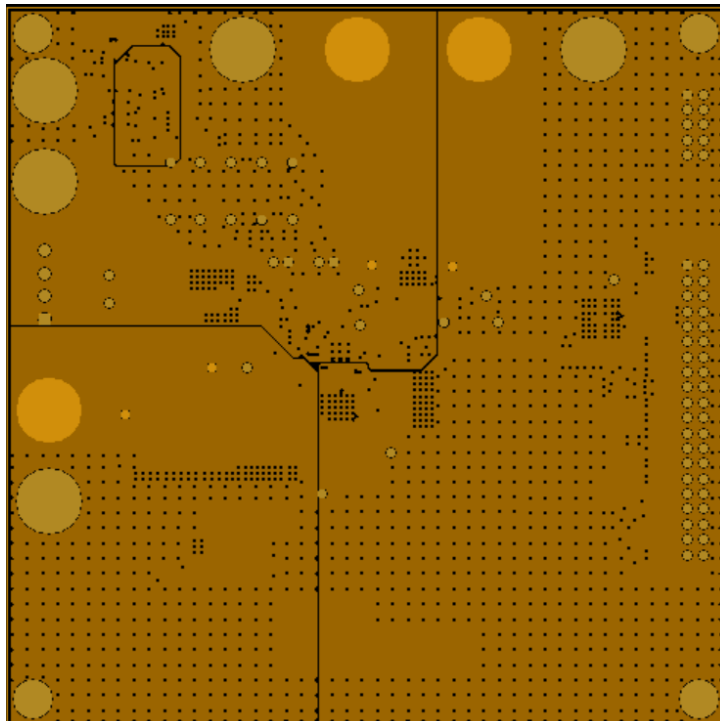

Figure 36. BD99954 EVK PWR Inner Layer2

9.4 Bottom Layer

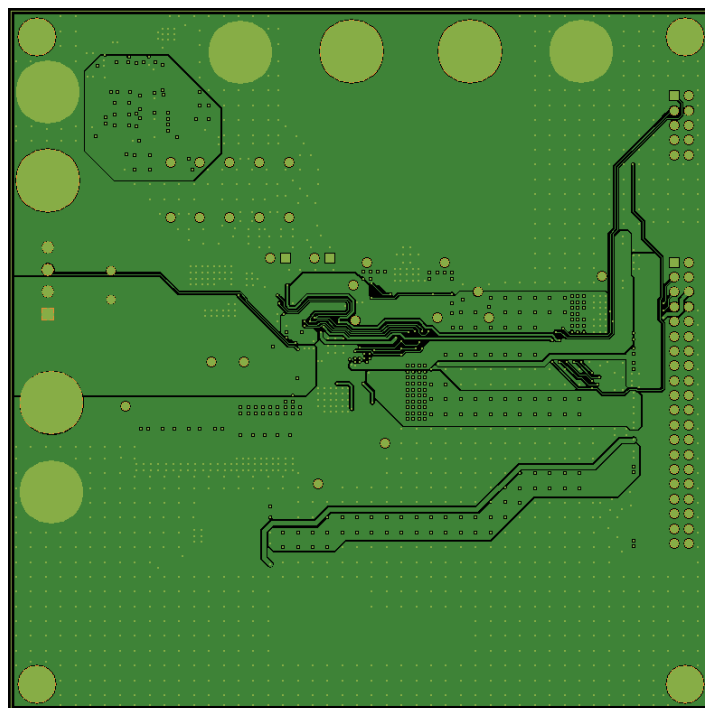

Figure 37. BD99954 EVK Bottom Layer

10 Bill of Materials

Item	Quantity	Reference	Description	Manufacturer	Manufacturer PN
1	1	CN5	CONN TERM BLOCK 4POS 3.81MM	PHOENIX CONTACT	1727036
2	1	CN10	CONN HEADER VERT DUAL 40POS	3M	961240-6404-AR
3	5	C1, C27, C28, C32	CAP CER 22UF 25V X5R 0805	Murata	GRM21BR61E226ME4 4K
4	2	C2, C30	CAP CER 0.1UF 35V X5R 0805	Taiyo Yuden	GMK212BJ104KGHT
5	12	C3, C4, C11, C12, C13, C17, C19, C20, C22, C23, C26, C37	CAP CER 0.1UF 50V X5R 0402	Murata	GRM155R61H104KE14 D
6	1	C6	CAP CER 10UF 50V X5R 1206	TDK Corporation	C3216X5R1H106K160 AB
7	1	C7	CAP CER 1UF 50V X5R 060301005	TDK Corporation	C1608X5R1H105M080 AB
8	3	C8, C9, C60	CAP CER 4.7UF 25V X5R 0805	Murata	GRM21BR61E475KA12 L
9	1	C10	CAP CER 1UF 50V X5R 060301005	TDK Corporation	C1608X5R1H105M080 AB
10	1	C14	CAP CER 10UF 10V X5R 0805	TDK Corporation	C2012X5R1A106M085 AB
11	1	C29	CAP CER 1UF 10V X5R 0805	Murata	GRM219R61A105KA01 D
12	1	C41	CAP TANT POLY 22UF 25V 1411	Kemet	T521B226M025ATE100
13	1	L1	INDUCTOR 11.2 X 10.3 X 1.5 2.2UH	Cyntec	CMLB101E-2R2MS

14	5	Q1, Q2, Q3, Q4, Q7	MOSFET N-CH 30V 11A 8-HUML	Rohm Semiconductor	RF4E110GN
15	2	Q10, Q11	MOSFET 2N-CH 30V 30A SOT-23	Vishay	SIZ340DT-T1-GE3
16	1	Q12	NCH 20V 150MA SM SIG MOSFET, VML	Rohm Semiconductor	RV3C002UNT2CL
17	2	R1, R2	0.01, 1W, 0.5%	Susumu	RL1632L4-R010-DN
18	4	R3, R4, R6, R15	RES SMD 10K OHM 5% 1/16W 0402	Rohm Semiconductor	MCR01MZPJ103
19	1	R5	RES SMD 15K OHM 5% 1/16W 0402	Rohm Semiconductor	MCR01MRTJ153
20	4	R7, R8, R38, R39	RES SMD 0.0OHM JUMPER 1/16W 0402	Rohm Semiconductor	MCR01MRTJ000
21	5	R10, R11, R12, R13, R14	RES SMD 47K OHM 5% 1/16W 0402	Rohm Semiconductor	MCR01MRTJ473
22	4	R26, R27, R40, R41	RES SMD 0.0 OHM JUMPER 1/8W 0805	Rohm Semiconductor	TRR10EZPJ000
23	4	R28, R29, R30, R31	RES SMD 7.5OHM 1/16W 0402	Rohm Semiconductor	MCR01MRTJ7R5
24	1	R32	RES SMD 470 OHM 5% 1/8W 0805	Rohm Semiconductor	MCR10ERTJ471
25	1	R33	RES SMD 100 OHM 1% 1W 2512	Rohm Semiconductor	MCR100JZHF1000
26	2	R34, R35	RES SMD 0.0 OHM JUMPER 1W 2512	Rohm Semiconductor	MCR100JZHJ000

Table 3. BD99954 EVK Reference Design BOM

10.1 Bill of Materials: USB-to-I2C Schematic

(These parts are included in the EVK for the USB to I2C communication and are not required to be included in the reference design)

Item	Quantity	Reference	Description	Manufacturer	Manufacturer PN
1	10	C57, C58, C61, C51, C59, C52, C53, C54, C55, C56	CAP CER 0.1UF 50V X5R 0402	Murata	GRM155R61H104KE14D
2	2	C48, C49	CAP CER 20PF 25V C0G/NP0 0402	Murata	GRM1555C1E200JA01D
3	1	C50	CAP CER 4.7UF 25V X5R 0805	Murata	GRM21BR61E475KA12L
4	3	L4, L5, L6	FERRITE BEAD 600 OHM 0603 1LN	Murata	BLM18AG601SN1D
5	3	R42, R43, R44	RES SMD 0.0OHM JUMPER 1/16W 0402	Rohm Semiconductor	MCR01MRTJ000
6	1	R46	RES SMD 2K OHM 5% 1/16W 0402	Rohm Semiconductor	MCR01MRTJ202
7	1	R47	RES SMD 10K OHM 5% 1/16W 0402	Rohm Semiconductor	MCR01MZPJ103
8	1	R45	RES SMD 12K OHM 1% 1/16W 0402	Rohm Semiconductor	MCR01MRTF1202
9	1	R51	RES SMD 47K OHM 5% 1/16W 0402	Rohm Semiconductor	MCR01MRTJ473
10	1	R48	RES SMD 47K OHM 5% 1/16W 0402	Rohm Semiconductor	MCR01MRTJ473
11	2	D1, D2	TVS DIODE 24VWM 150VC 0603	Littelfuse Inc	PGB1010603NRHF
12	1	D19	LED GREEN DIFFUSED 0603 SMD	OSRAM	LG L29K-F2J1-24-Z
13	1	Y3	CRYSTAL 12.000 MHZ 20PF SMD	ECS	ECS-120-20-5PX-TR
14	1	U2	IC HS USB TO UART/FIFO 48LQFP	FTDI	FT232HL-REEL
15	1	U3	IC EEPROM 2KBIT 2MHZ SOT23-6	Microchip	93LC56BT-I/OT

Table4. BD99954 EVK BOM for USB-I2C

Revision History

Revision No.	Description	Revision Date
001	Initial Release	4 th October 2017