



CERAMIC

Bandpass Filter

BFHK-6251+

50Ω 5.35 to 6.7 GHz

THE BIG DEAL

- Ultra-High Stopband Rejection Structure – 76 dB typical
- Surface mountable pick and place standard case style
- Standard small 1812 (4.5mm x 3.2mm) case style
- High quality distributed filter topology
- Wide rejection band
- Shielded construction preventing filter from de-tuning
- Reduced footprint area by employing LGA (land grid array)
- Suited for very high-volume production
- Protected by US Patents 11,638,370 and 11,744,057



Generic photo used for illustration purposes only

CASE STYLE: NM1812C-3

+RoHS Compliant

The +Suffix identifies RoHS Compliance. See our website for methodologies and qualifications

APPLICATIONS

- Test and Measurement
- Aerospace and Defense Signal Conditioning

PRODUCT OVERVIEW

The BFHK-6251+ LTCC Band Pass Filter achieves a miniature size and high repeatability of performance by utilizing a proprietary LTCC material system and distributed filter topology. The passband loss at 5.35 – 6.7 GHz is as low as 3.2 dB, with typical stopband rejections at 76 dB up to 15.5 GHz. This model handles up to 1W RF input power, and provides a wide operating temperature range from -55 to +125°C. Utilizing a proprietary LTCC material system and a distributed filter topology, this filter is able to achieve repeatable performance on a lot-to-lot basis.

KEY FEATURES

Feature	Advantages
Ultra-High Rejection	Typical stopband rejections at 76 dB up to 15.5 GHz
Cost effective	LTCC is scalable technology that is cost effective due to ease of production in high quantities.
Small size (4.5mm x 3.2mm)	Allows for high layout density of circuit boards, while minimizing effects of parasitics.
Surface Mountable	Suitable for very high volume automated assembly process.

REV. A
ECO-019695
BFHK-6251+
WY/CP/AM
231102





CERAMIC

Bandpass Filter

BFHK-6251+

ELECTRICAL SPECIFICATIONS¹ AT 25°C

Parameter	F#	Frequency (GHz)	Min.	Typ.	Max.	Units
Center Frequency	—	—	—	6.1	—	GHz
Pass Band	Insertion Loss	F1-F2	—	3.2	4.5	dB
	Return Loss	F1-F2	—	13.0	—	dB
Stop Band, Lower	Insertion Loss	DC-F3	70	80	—	dB
Stop Band, Upper	Insertion Loss	F4-F5	66	76	—	dB

1. Measured on Mini-Circuits Test Board TB-BFHK-6251C+ with feedline losses removed by normalization of S12 and S21 traces to measurements of TB thru-line

MAXIMUM RATINGS

Parameter	Ratings
Operating Temperature	-55°C to 125°C
Storage Temperature	-55°C to 125°C
RF Power Input	1W max.

Permanent damage may occur if any of these limits are exceeded

TYPICAL FREQUENCY RESPONSE

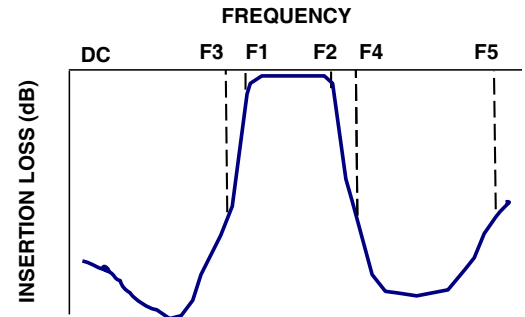

FUNCTIONAL SCHEMATIC

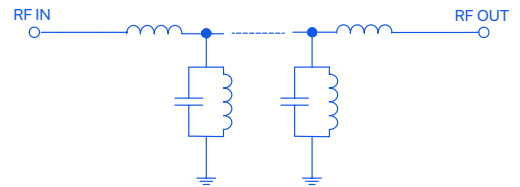



CERAMIC

Bandpass Filter

BFHK-6251+

EVALUATION BOARD MCL P/N: TB-BFHK-6251C+ SUGGESTED PCB LAYOUT: PL-730

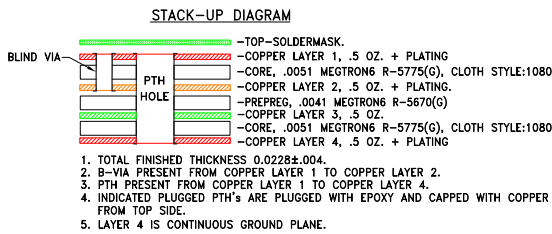
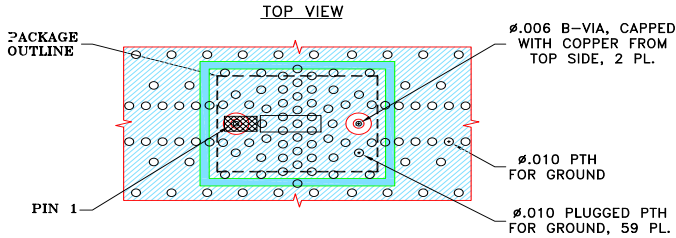

NOTES:

1. PCB IS MULTILAYER PCB, SEE STACK-UP DIAGRAM.
2. TRACE WIDTH & GAP PARAMETERS ARE SHOWN FOR MEGTRON6 R-5775(G), CLOTH STYLE:1080 WITH DIELECTRIC THICKNESS .0051; COPPER: 1/2 OZ.+PLATING. FOR OTHER MATERIALS TRACE WIDTH AND GAP MAY NEED TO BE MODIFIED.
3. COPPER LAYER 4 OF THE PCB ARE CONTINUOUS GROUND PLANE.

- DENOTES PCB COPPER LAYOUT WITH SMOBC (SOLDER MASK OVER BARE COPPER)
- DENOTES COPPER LAND PATTERN FREE OF SOLDER MASK

LAYER 2, B-VIA & PTH

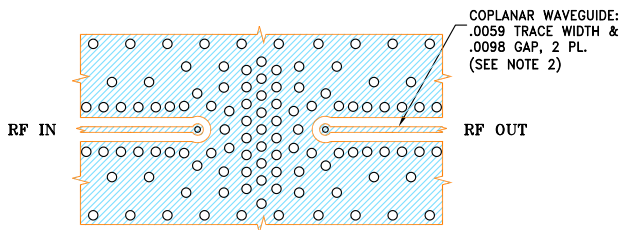

LAYER 3 & PTH

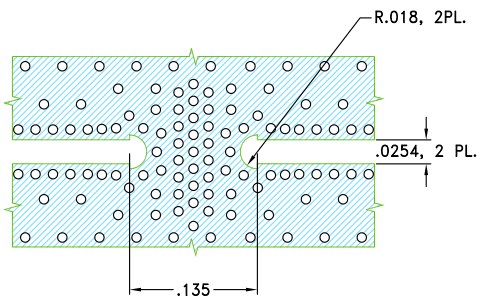

PAD CONNECTIONS

INPUT	1
OUTPUT	2
GROUND	3

PRODUCT MARKING: F479

OUTLINE DRAWING

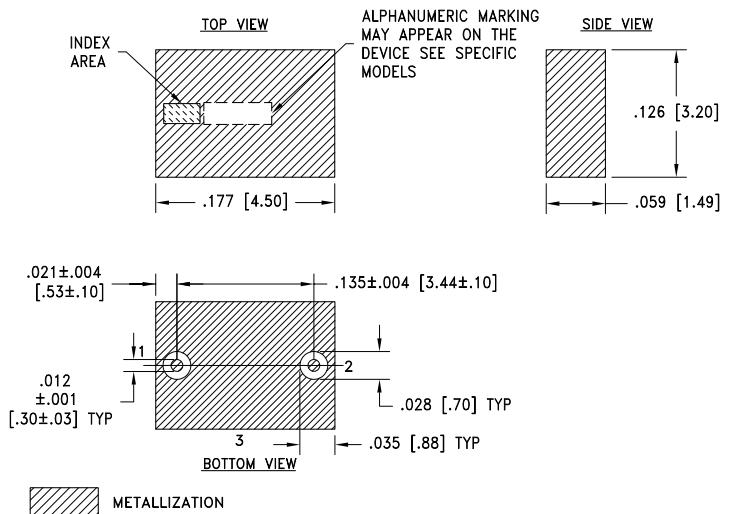

Weight: .126 grams.

Dimensions are in inches [mm]. Tolerances: 2Pl.±.01; 3Pl. ±.005