

BFP405

Surface mount wideband silicon NPN RF bipolar transistor



Product description

The BFP405 is a low noise device based on a grounded emitter (SIEGET™) that is part of Infineon’s established fourth generation RF bipolar transistor family. Its transition frequency f_T of 25 GHz and low current characteristics make the device suitable for oscillators up to 12 GHz. It remains cost competitive without compromising on ease of use.



Feature list

- Minimum noise figure $NF_{min} = 1.25$ dB at 1.8 GHz, 2 V, 2 mA
- High gain $G_{ms} = 23$ dB at 1.8 GHz, 2 V, 5 mA
- $OIP_3 = 15$ dBm at 1.8 GHz, 2 V, 5 mA

Product validation

Qualified for industrial applications according to the relevant tests of JEDEC47/20/22.

Potential applications

- Radio-frequency oscillators
- Broadband low noise amplifiers (LNAs) for CATV, DVB-T, DAB/DMB and FM/AM radio
- LNAs for sub-1 GHz ISM band applications

Device information

Table 1 Part information

Product name / Ordering code	Package	Pin configuration				Marking	Pieces / Reel
BFP405 / BFP405H6327XTSA1	SOT343	1 = B	2 = E	3 = C	4 = E	ALs	3000

Attention: ESD (Electrostatic discharge) sensitive device, observe handling precautions

Table of contents

Table of contents

	Product description	1
	Feature list	1
	Product validation	1
	Potential applications	1
	Device information	1
	Table of contents	2
1	Absolute maximum ratings	3
2	Thermal characteristics	4
3	Electrical characteristics	6
3.1	DC characteristics	6
3.2	General AC characteristics	6
3.3	Frequency dependent AC characteristics	7
3.4	Characteristic AC diagrams	8
4	Package information SOT343	13
	Revision history	14
	Disclaimer	15

Absolute maximum ratings

1 Absolute maximum ratings

Table 2 Absolute maximum ratings at $T_A = 25\text{ °C}$ (unless otherwise specified)

Parameter	Symbol	Values		Unit	Note or test condition	
		Min.	Max.			
Collector emitter voltage	V_{CEO}	-	4.5	V	Open base	
			4.1			$T_A = -55\text{ °C}$, open base
Collector emitter voltage	V_{CES}		15			E-B short circuited
Collector base voltage	V_{CBO}		15			Open emitter
Emitter base voltage	V_{EBO}		1.5			Open collector
Base current	I_B		3	mA	-	
Collector current	I_C		25			
Total power dissipation ¹⁾	P_{tot}			75	mW	$T_S \leq 110\text{ °C}$
Junction temperature	T_J		150	°C	-	
Storage temperature	T_{Stg}	-55				

Attention: *Stresses above the max. values listed here may cause permanent damage to the device. Exposure to absolute maximum rating conditions for extended periods may affect device reliability. Exceeding only one of these values may cause irreversible damage to the integrated circuit.*

¹ T_S is the soldering point temperature. T_S is measured on the emitter lead at the soldering point of the PCB.

Thermal characteristics

2 Thermal characteristics

Table 3 Thermal resistance

Parameter	Symbol	Values			Unit	Note or test condition
		Min.	Typ.	Max.		
Junction - soldering point	R_{thJS}	-	530	-	K/W	-

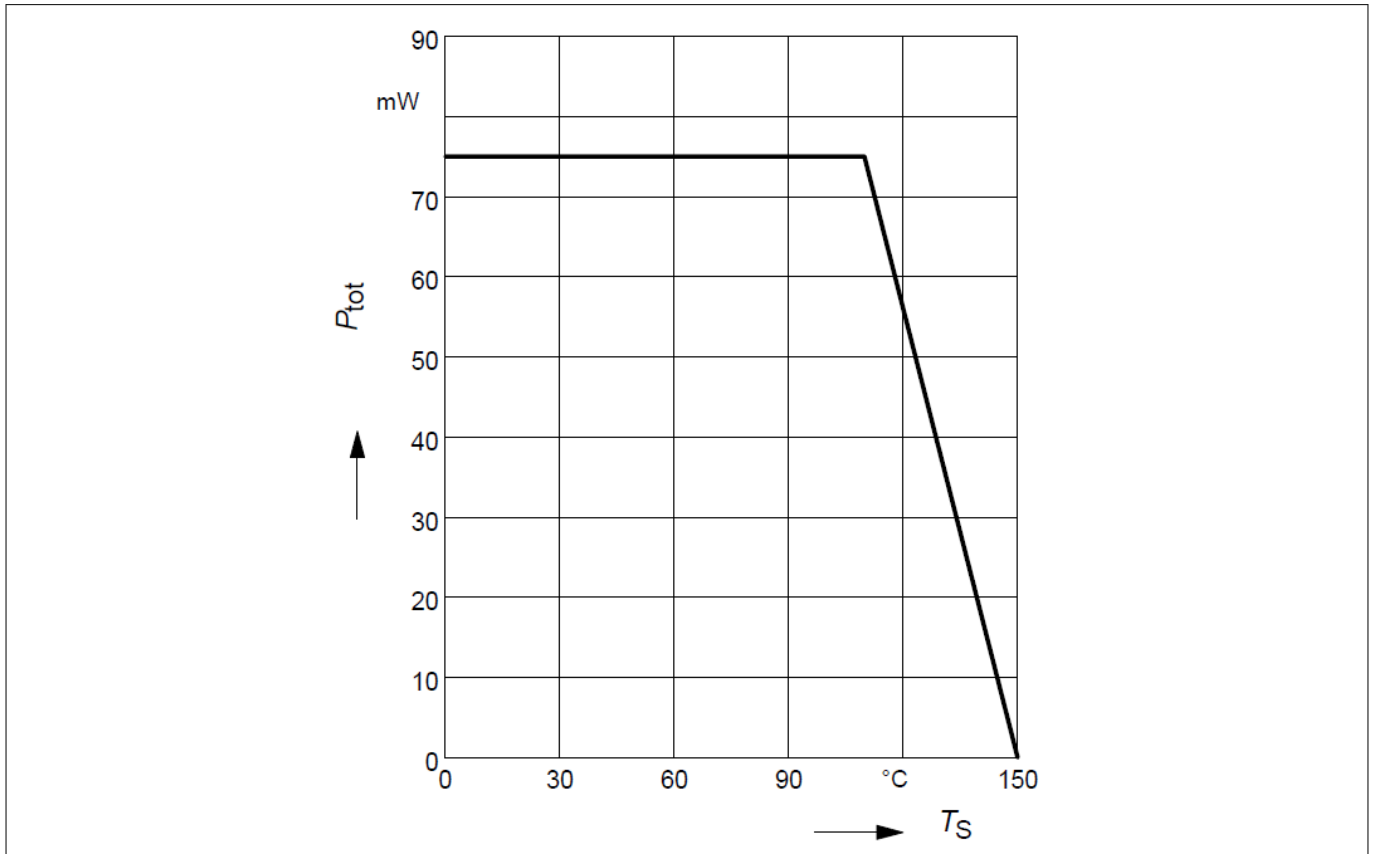

Figure 1 Total power dissipation $P_{tot} = f(T_S)$

Thermal characteristics

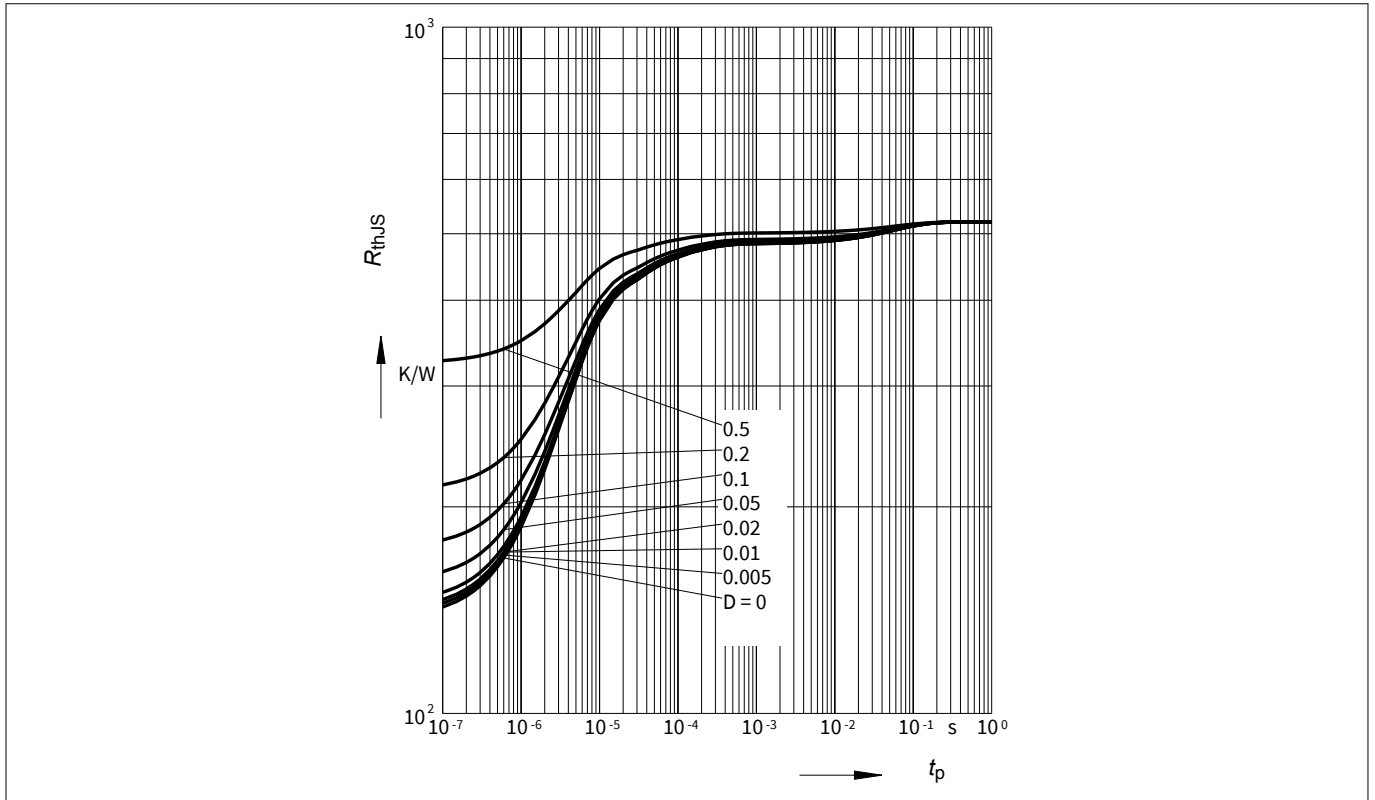

Figure 2 Permissible pulse load $R_{thJS} = f(t_p)$

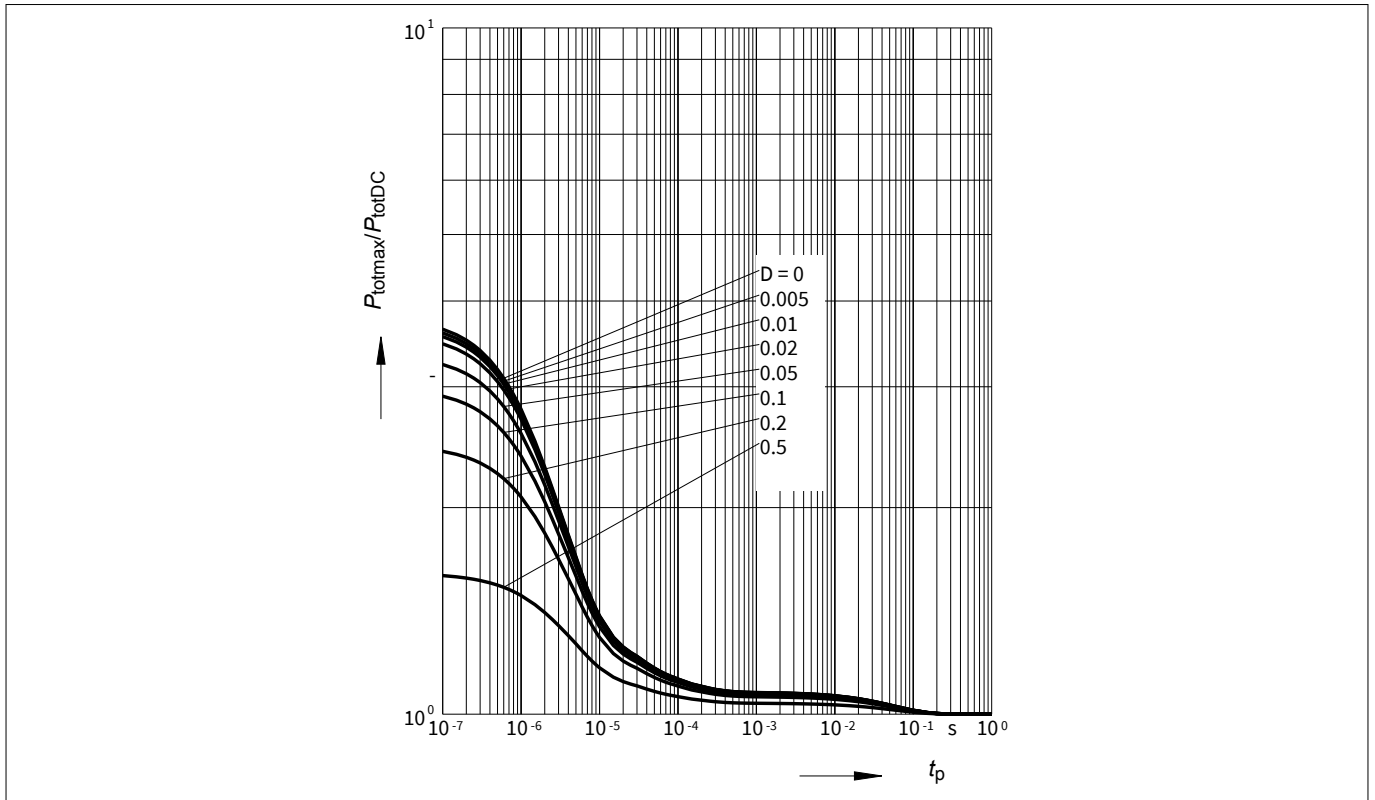

Figure 3 Permissible pulse load $P_{tot,max} / P_{tot,DC} = f(t_p)$

Electrical characteristics

3 Electrical characteristics

3.1 DC characteristics

Table 4 DC characteristics at $T_A = 25\text{ °C}$

Parameter	Symbol	Values			Unit	Note or test condition
		Min.	Typ.	Max.		
Collector emitter breakdown voltage	$V_{(BR)CEO}$	4.5	5	–	V	$I_C = 1\text{ mA}$, $I_B = 0$, open base
Collector emitter leakage current	I_{CES}	–	–	10 ²⁾	μA	$V_{CE} = 15\text{ V}$, $V_{BE} = 0$, E-B short circuited
Collector base leakage current	I_{CBO}			100 ²⁾	nA	$V_{CB} = 5\text{ V}$, $I_E = 0$, open emitter
Emitter base leakage current	I_{EBO}			1 ²⁾	μA	$V_{EB} = 0.5\text{ V}$, $I_C = 0$, open collector
DC current gain	h_{FE}	60	95	130		$V_{CE} = 4\text{ V}$, $I_C = 5\text{ mA}$, pulse measured

3.2 General AC characteristics

Table 5 General AC characteristics at $T_A = 25\text{ °C}$

Parameter	Symbol	Values			Unit	Note or test condition
		Min.	Typ.	Max.		
Transition frequency	f_T	18	25	–	GHz	$V_{CE} = 3\text{ V}$, $I_C = 10\text{ mA}$, $f = 2\text{ GHz}$
Collector base capacitance	C_{CB}	–	0.05	0.1	pF	$V_{CB} = 2\text{ V}$, $V_{BE} = 0$, $f = 1\text{ MHz}$, emitter grounded
Collector emitter capacitance	C_{CE}		0.24	–		$V_{CE} = 2\text{ V}$, $V_{BE} = 0$, $f = 1\text{ MHz}$, base grounded
Emitter base capacitance	C_{EB}		0.29			$V_{EB} = 0.5\text{ V}$, $V_{CB} = 0$, $f = 1\text{ MHz}$, collector grounded

²⁾ Maximum values not limited by the device but by the short cycle time of the 100% test.

Electrical characteristics

3.3 Frequency dependent AC characteristics

Measurement setup is a test fixture with Bias-T's in a 50 Ω system, $T_A = 25\text{ °C}$.

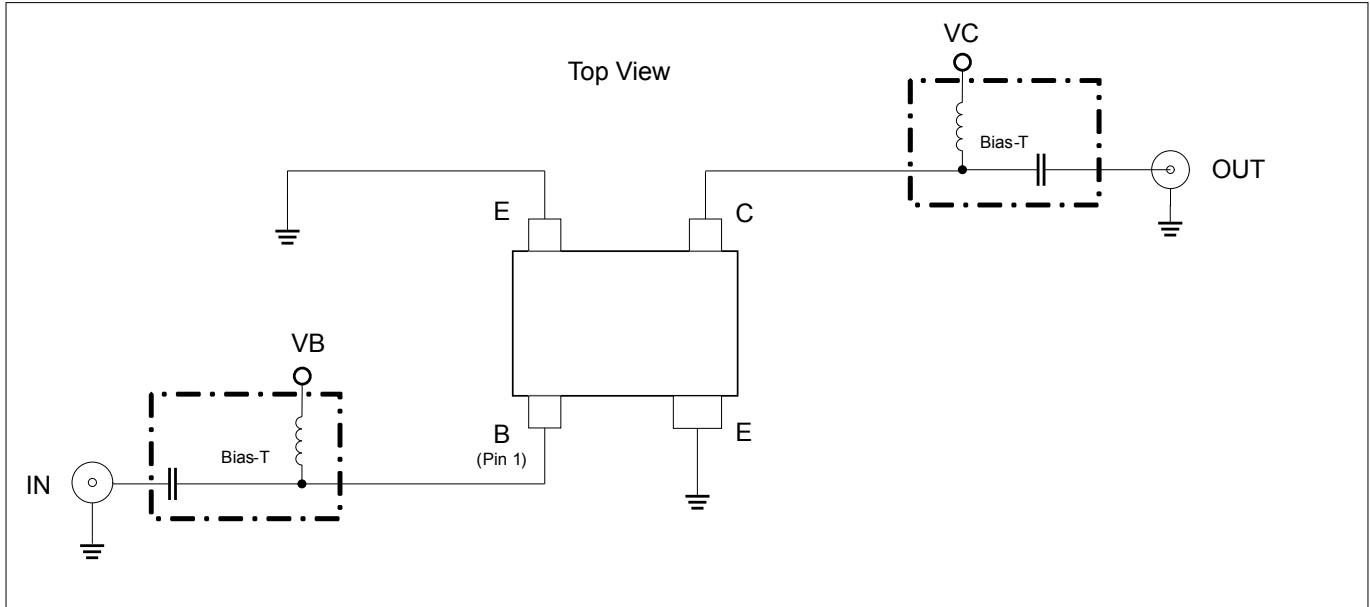

Figure 4 Testing circuit

Table 6 AC characteristics, $V_{CE} = 2\text{ V}$, $f = 1.8\text{ GHz}$

Parameter	Symbol	Values			Unit	Note or test condition
		Min.	Typ.	Max.		
Power gain					dB	$I_C = 5\text{ mA}$
• Maximum power gain	G_{ms}	–	23	–		
• Transducer gain	$ S_{21} ^2$	14	18.5			
Noise figure					dBm	$I_C = 2\text{ mA}$
• Minimum noise figure	NF_{min}	–	1.25			
Linearity						$Z_S = Z_L = 50\text{ }\Omega$, $I_C = 5\text{ mA}$
• 3rd order intercept point at output	OIP_3		15			
• 1 dB gain compression point at output	OP_{1dB}		5			

Note: $G_{ms} = IS_{21} / S_{12} I$ for $k < 1$; $G_{ma} = IS_{21} / S_{12} I (k - (k^2 - 1)^{1/2})$ for $k > 1$. In order to get the NF_{min} values stated in this chapter the test fixture losses have been subtracted from all measured results. OIP_3 value depends on termination of all intermodulation frequency components. Termination used for this measurement is 50 Ω from 0.1 MHz to 12 GHz.

Electrical characteristics

3.4 Characteristic AC diagrams

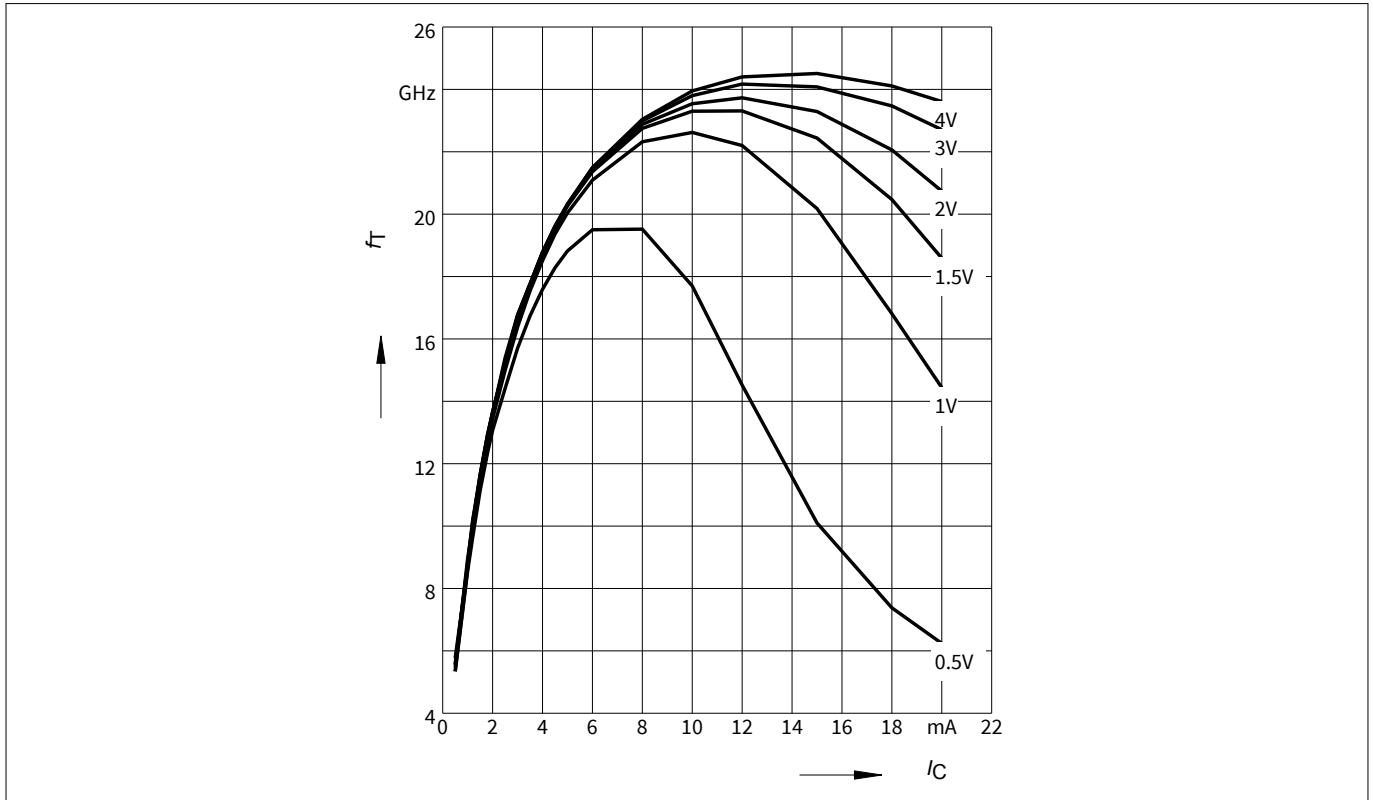

Figure 5 Transition frequency $f_T = f(I_C)$, $f = 2$ GHz, $V_{CE} = \text{parameter}$

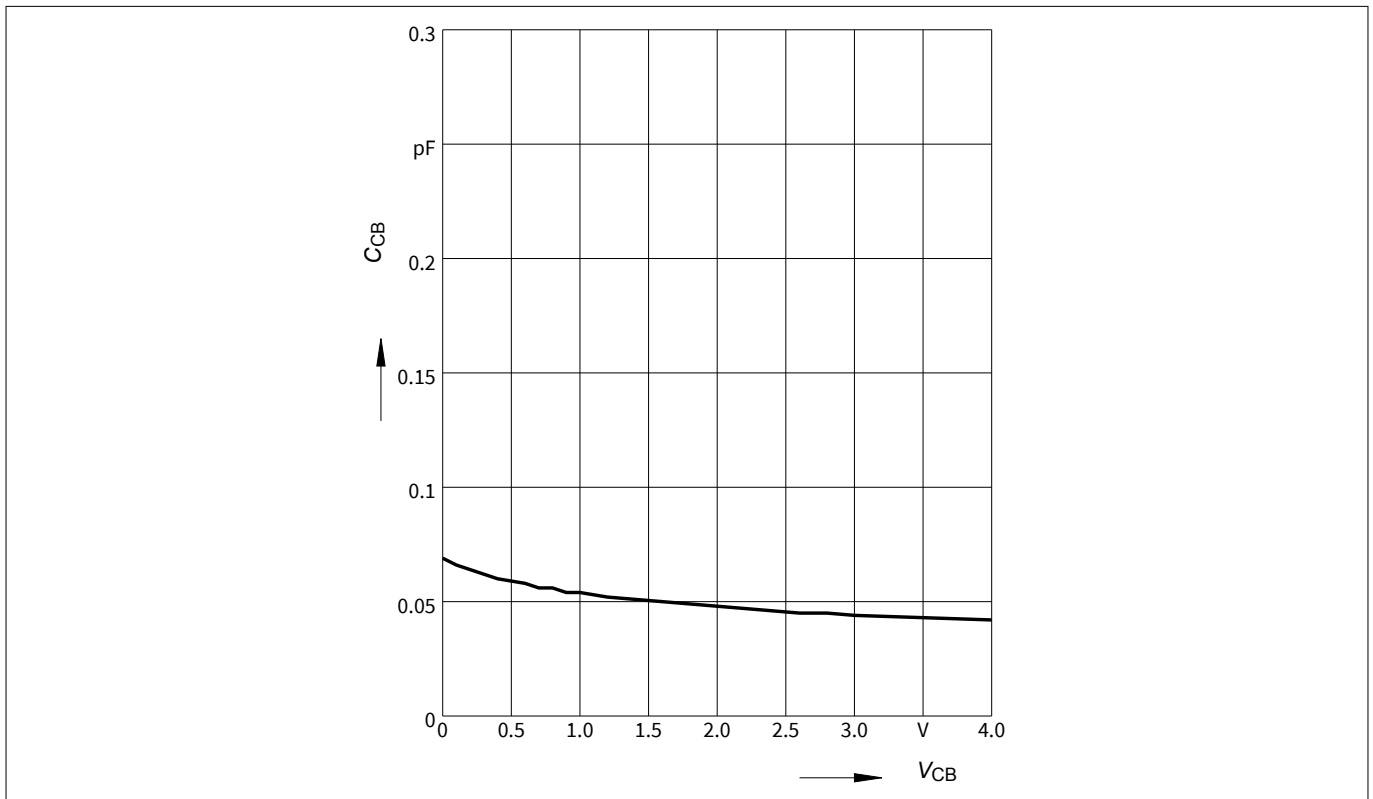

Figure 6 Collector base capacitance $C_{CB} = f(V_{CB})$, $f = 1$ MHz

Electrical characteristics

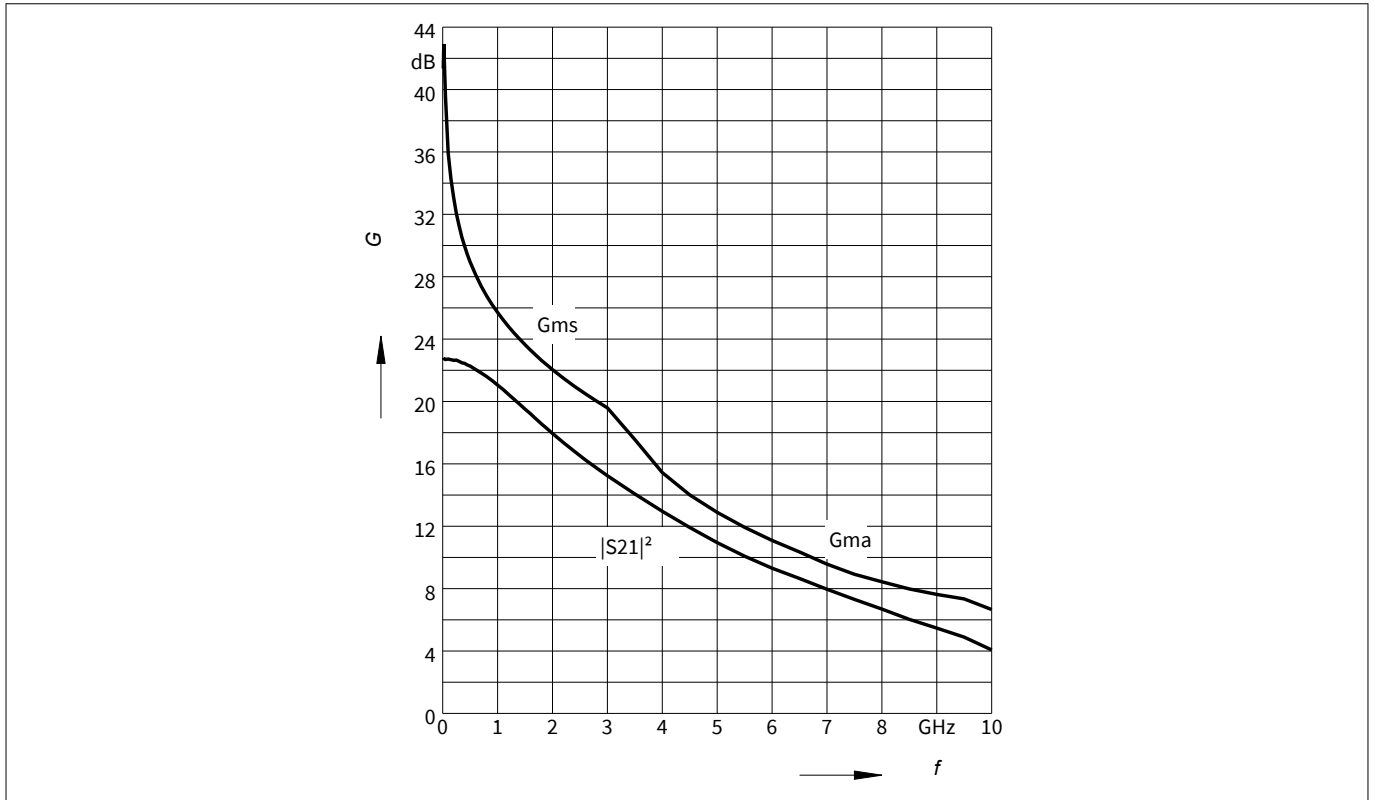

Figure 7 Gain G_{ma} , G_{ms} , $|S_{21}|^2 = f(f)$, $V_{CE} = 3\text{ V}$, $I_C = 5\text{ mA}$

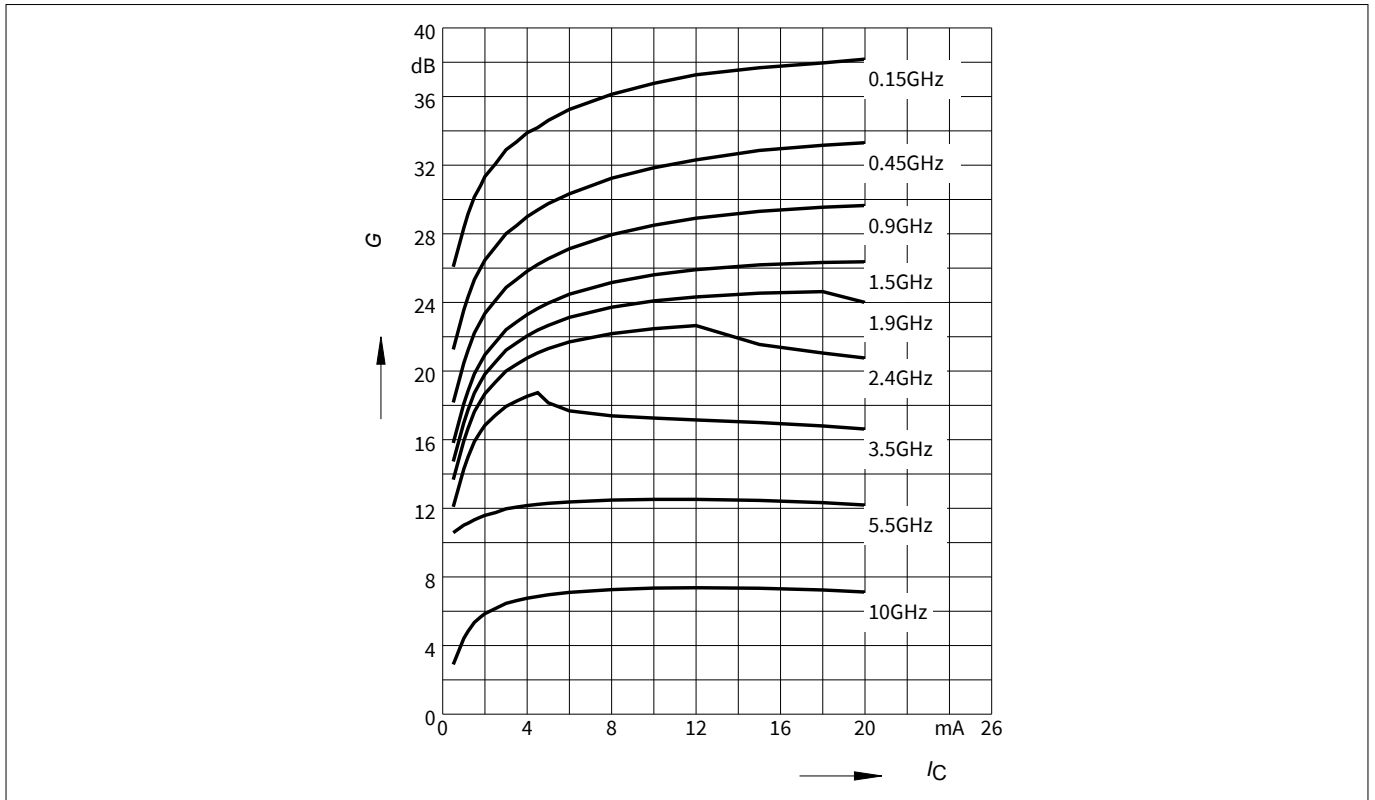

Figure 8 Maximum power gain $G_{max} = f(I_C)$, $V_{CE} = 3\text{ V}$, $f = \text{parameter in GHz}$

Electrical characteristics

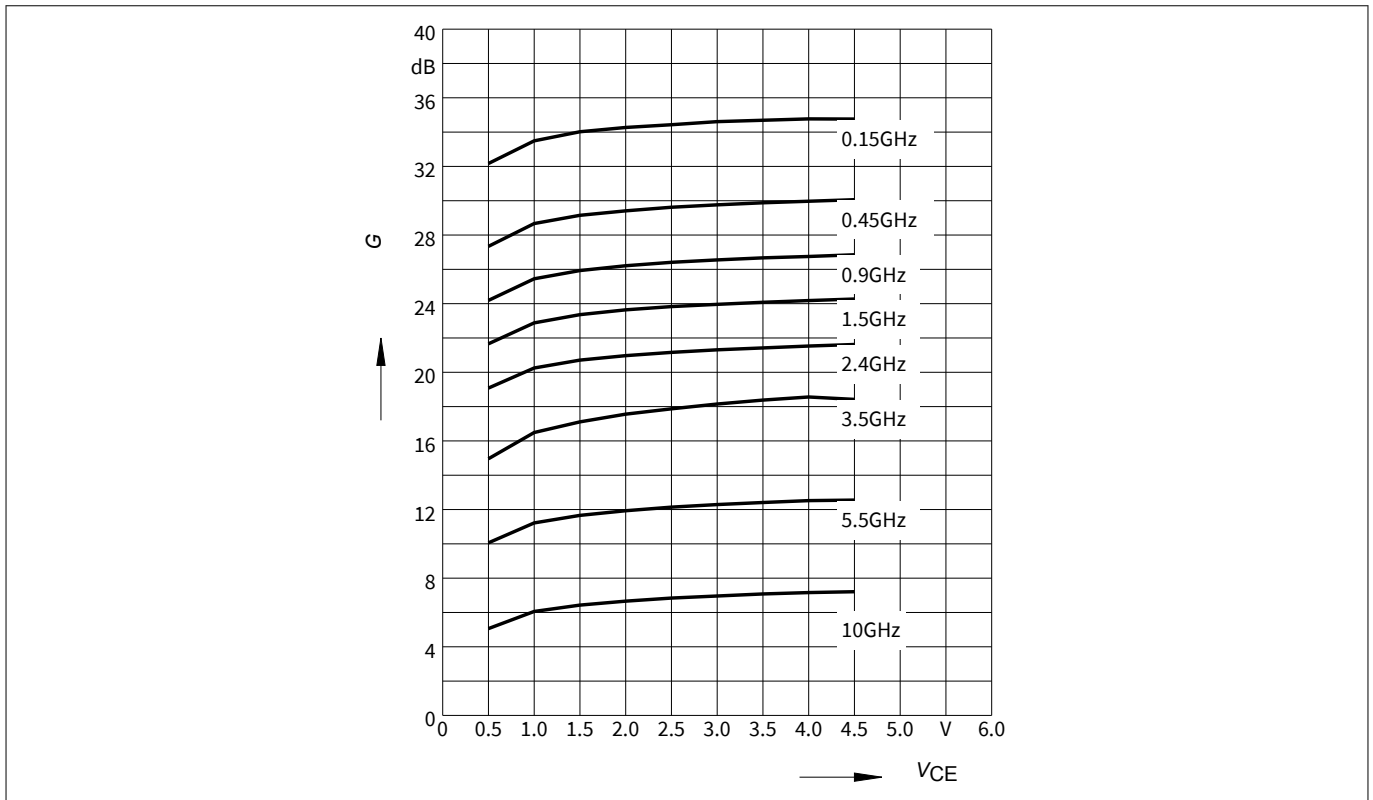

Figure 9 Maximum power gain $G_{max} = f(V_{CE})$, $I_C = 5 \text{ mA}$, $f = \text{parameter in GHz}$

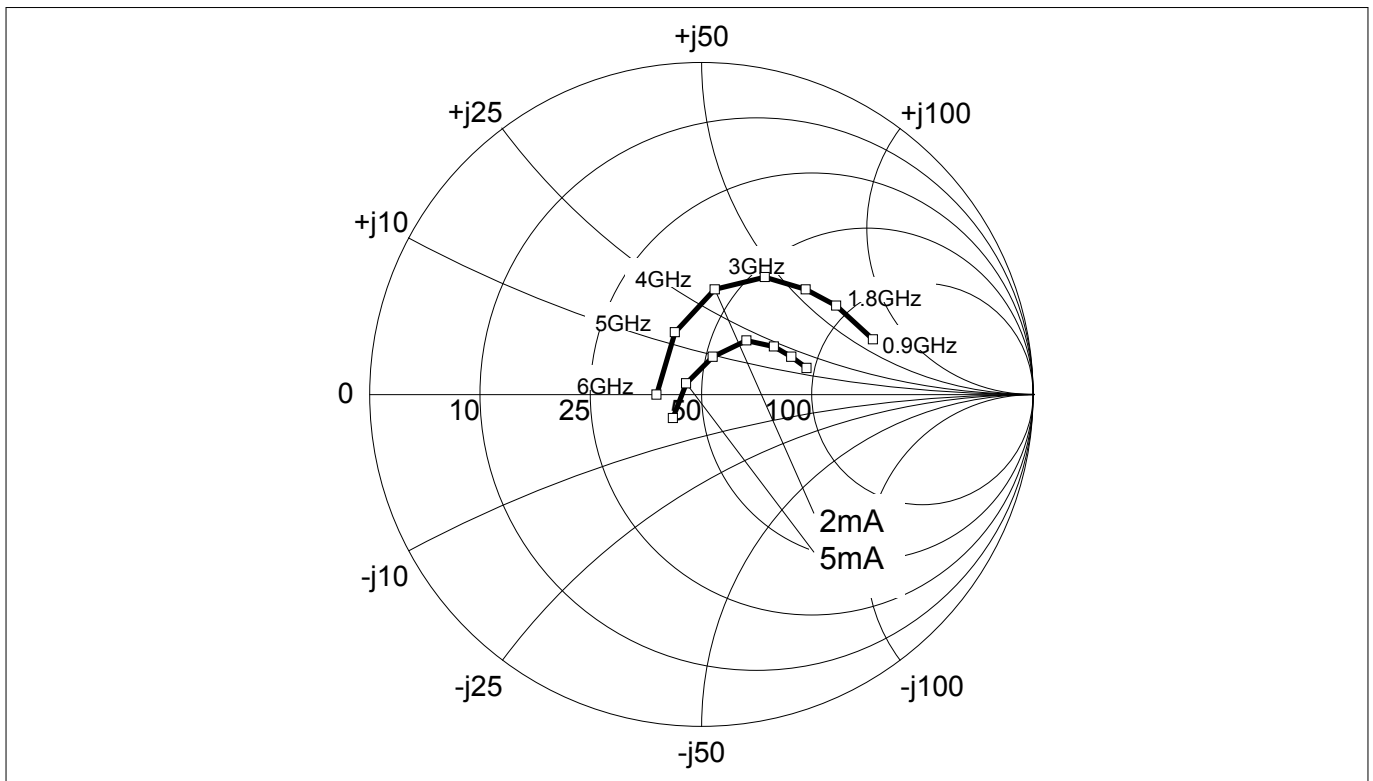

Figure 10 Source impedance for minimum noise figure $Z_{s,opt} = f(f)$, $V_{CE} = 3 \text{ V}$, $I_C = 2 / 5 \text{ mA}$

Electrical characteristics

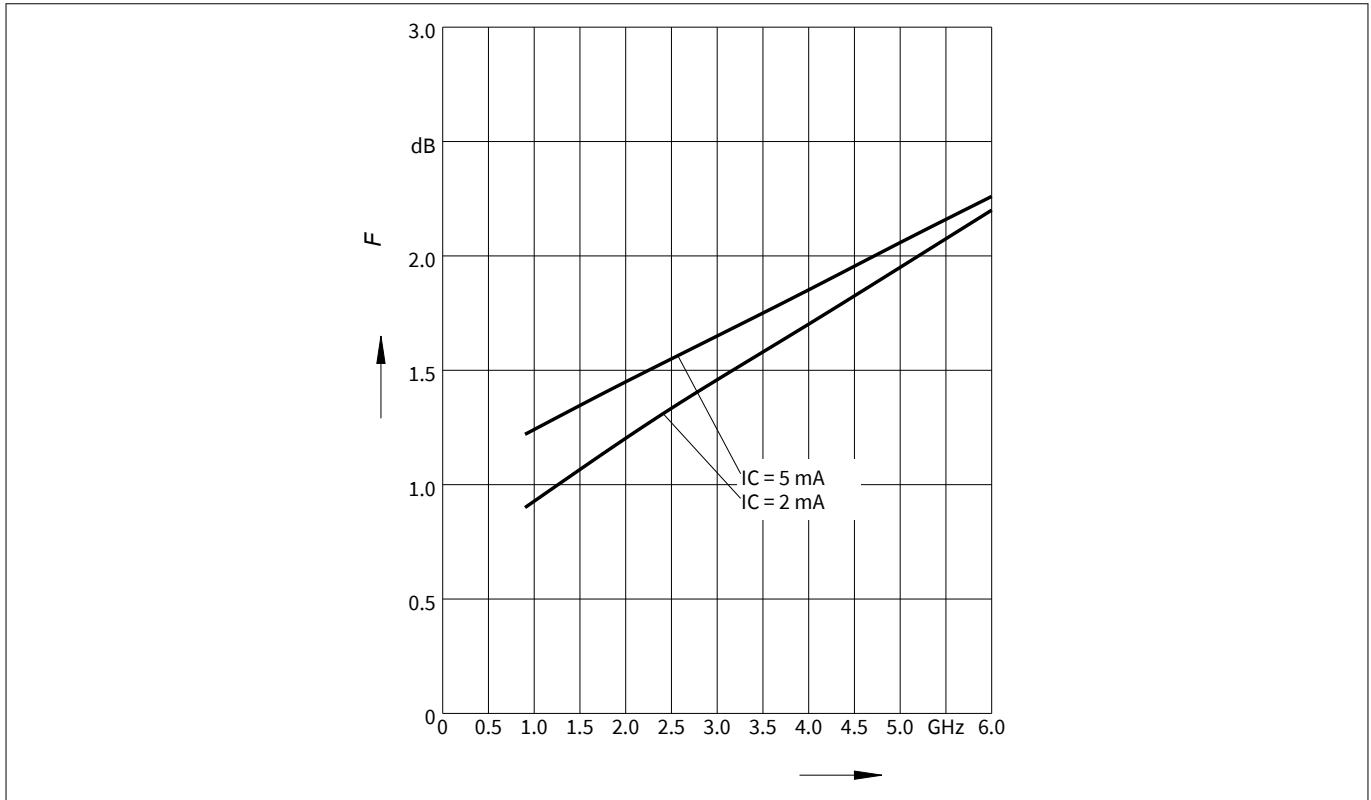

Figure 11 Noise figure $NF_{min} = f(f)$, $V_{CE} = 1\text{ V}$, $Z_S = Z_{S,opt}$, $I_C = 2 / 5\text{ mA}$

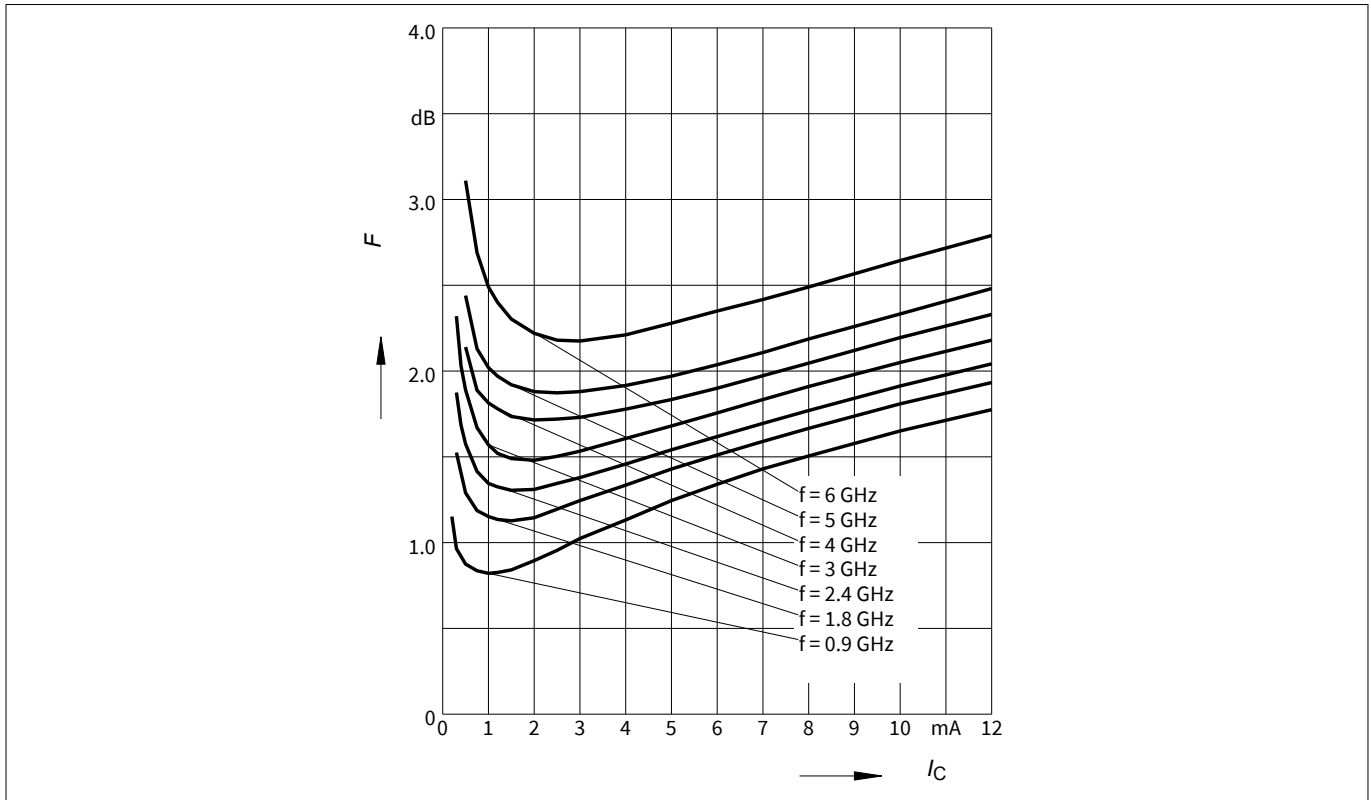

Figure 12 Noise figure $NF_{min} = f(I_C)$, $V_{CE} = 2\text{ V}$, $Z_S = Z_{S,opt}$, $f = \text{parameter in GHz}$

Electrical characteristics

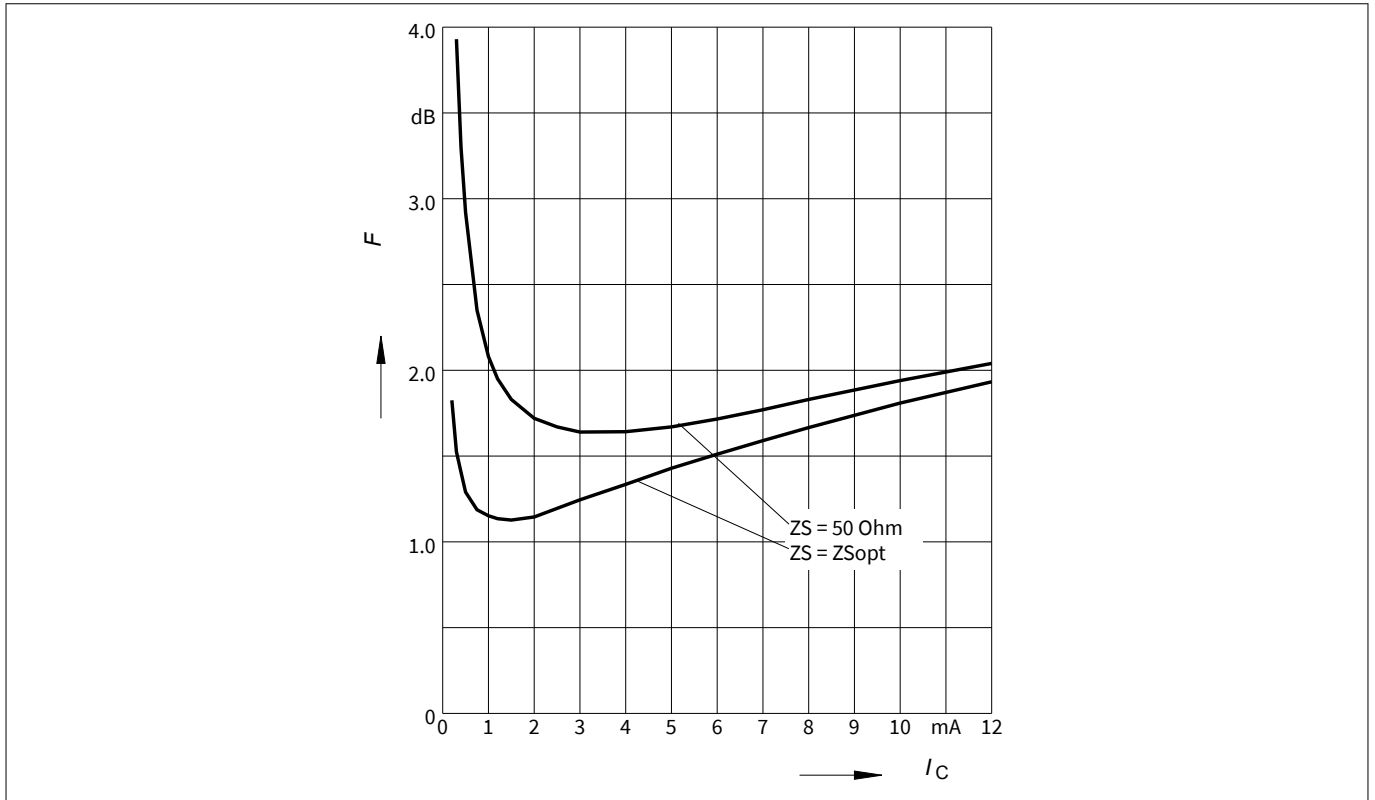

Figure 13 Noise figure $NF_{min} = f(I_C), Z_S = Z_{S,opt}, NF_{50} = f(I_C), Z_S = 50 \Omega, V_{CE} = 2 V, f = 1.8 GHz$

Note: The curves shown in this chapter have been generated using typical devices but shall not be considered as a guarantee that all devices have identical characteristic curves. $T_A = 25 \text{ }^\circ\text{C}$.

Package information SOT343

4 Package information SOT343

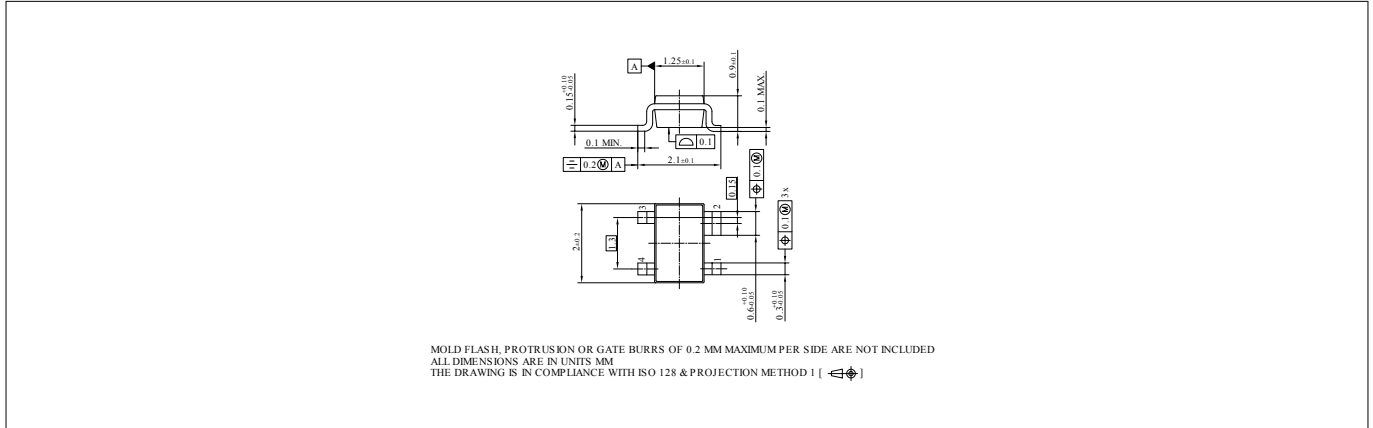

Figure 14 Package outline

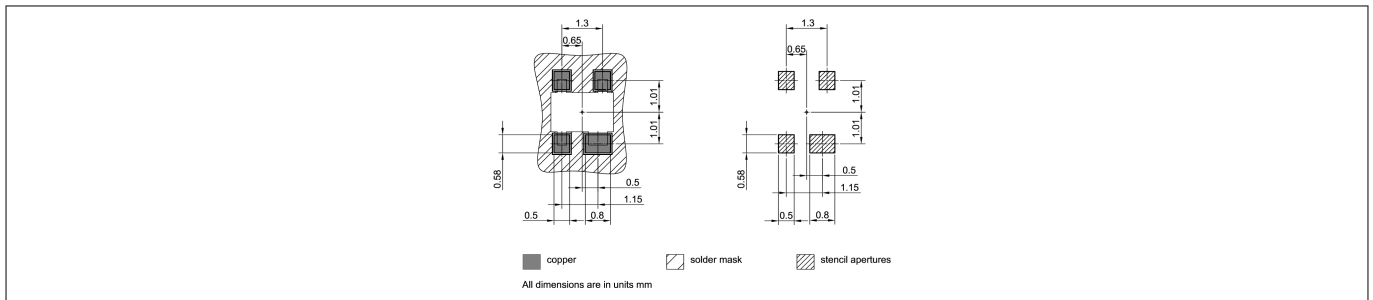

Figure 15 Foot print

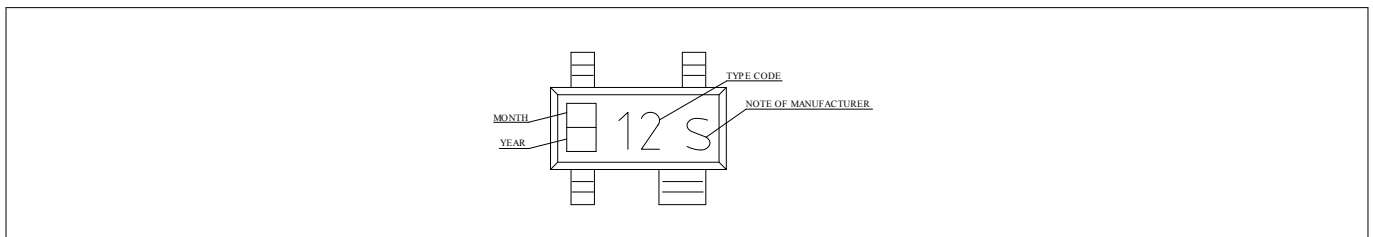

Figure 16 Marking layout example

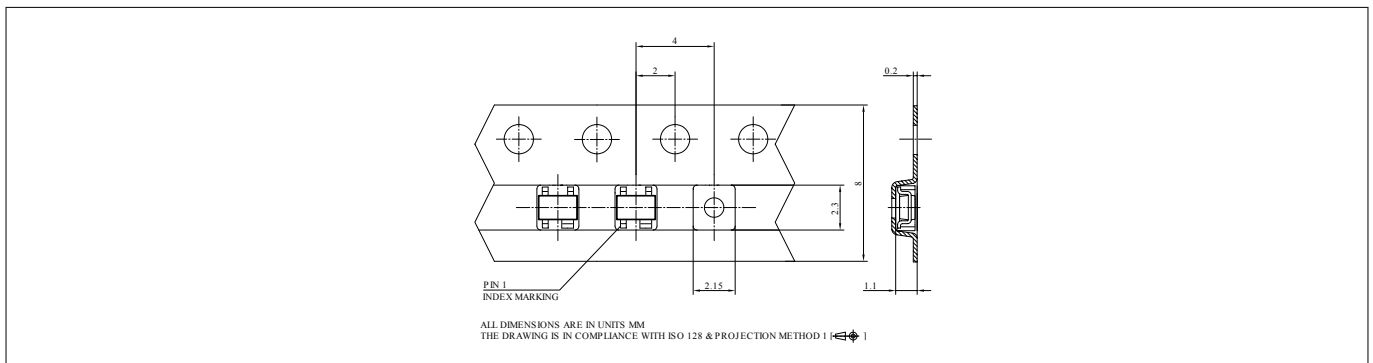

Figure 17 Tape dimensions

Revision history

Revision history

Document version	Date of release	Description of changes
Revision 2.0	2019-01-25	New datasheet layout.