

# BFP420F

## Low profile silicon NPN RF bipolar transistor



### Product description

The BFP420F is a low noise device based on a grounded emitter (SIEGET™) that is part of Infineon’s established fourth generation RF bipolar transistor family. Its transition frequency  $f_T$  of 25 GHz and low current characteristics make the device suitable for amplifiers up to 4.5 GHz. It remains cost competitive without compromising on ease of use.



### Feature list

- Minimum noise figure  $NF_{min} = 1.1$  dB at 1.9 GHz, 3 V, 4 mA
- High gain  $G_{ma} = 19$  dB at 1.9 GHz, 4 V, 40 mA
- $OIP_3 = 28$  dBm at 1.9 GHz, 4 V, 40 mA

### Product validation

Qualified for industrial applications according to the relevant tests of JEDEC47/20/22.

### Potential applications

- Radio-frequency oscillators
- Broadband low noise amplifiers (LNAs) for CATV, DVB-T, DAB/DMB and FM/AM radio
- LNAs for sub-1 GHz ISM band applications

### Device information

**Table 1** Part information

Product name / Ordering code	Package	Pin configuration				Marking	Pieces / Reel
BFP420F / BFP420FH6327XTSA1	TSFP-4-1	1 = B	2 = E	3 = C	4 = E	AMs	3000

**Attention:** ESD (Electrostatic discharge) sensitive device, observe handling precautions

---

**Table of contents**

**Table of contents**

	<b>Product description</b> .....	1
	<b>Feature list</b> .....	1
	<b>Product validation</b> .....	1
	<b>Potential applications</b> .....	1
	<b>Device information</b> .....	1
	<b>Table of contents</b> .....	2
<b>1</b>	<b>Absolute maximum ratings</b> .....	3
<b>2</b>	<b>Thermal characteristics</b> .....	4
<b>3</b>	<b>Electrical characteristics</b> .....	5
3.1	DC characteristics .....	5
3.2	General AC characteristics .....	5
3.3	Frequency dependent AC characteristics .....	6
3.4	Characteristic DC diagrams .....	10
3.5	Characteristic AC diagrams .....	13
<b>4</b>	<b>Package information TSFP-4-1</b> .....	20
	<b>Revision history</b> .....	21
	<b>Disclaimer</b> .....	22

**Absolute maximum ratings**

**1 Absolute maximum ratings**

**Table 2 Absolute maximum ratings at  $T_A = 25\text{ °C}$  (unless otherwise specified)**

Parameter	Symbol	Values		Unit	Note or test condition
		Min.	Max.		
Collector emitter voltage	$V_{CEO}$	-	4.5	V	Open base
			4.1		$T_A = -55\text{ °C}$ , open base
Collector base voltage	$V_{CBO}$		15		Open emitter
Collector emitter voltage	$V_{CES}$		15		E-B short circuited
Emitter base voltage	$V_{EBO}$		1.5		Open collector
Base current	$I_B$		9	mA	-
Collector current	$I_C$		60		
Total power dissipation <sup>1)</sup>	$P_{tot}$		210	mW	$T_S \leq 100\text{ °C}$
Junction temperature	$T_J$		150	°C	-
Storage temperature	$T_{Stg}$	-55			

**Attention:** *Stresses above the max. values listed here may cause permanent damage to the device. Exposure to absolute maximum rating conditions for extended periods may affect device reliability. Exceeding only one of these values may cause irreversible damage to the integrated circuit.*

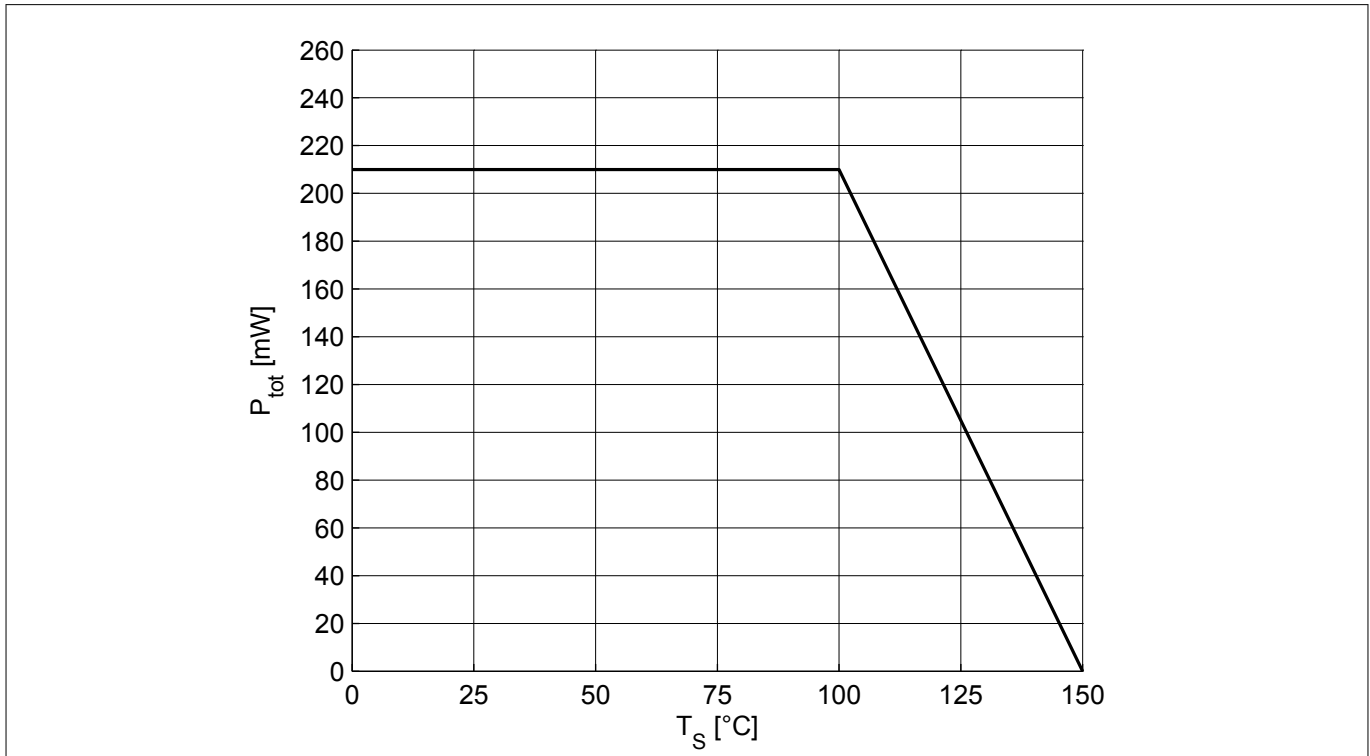
<sup>1</sup>  $T_S$  is the soldering point temperature.  $T_S$  is measured on the emitter lead at the soldering point of the PCB.

**Thermal characteristics**

**2 Thermal characteristics**

**Table 3 Thermal resistance**

Parameter	Symbol	Values			Unit	Note or test condition
		Min.	Typ.	Max.		
Junction - soldering point	$R_{thJS}$	-	240	-	K/W	-



**Figure 1 Total power dissipation  $P_{tot} = f(T_S)$**

**Electrical characteristics**

**3 Electrical characteristics**

**3.1 DC characteristics**

**Table 4 DC characteristics at  $T_A = 25\text{ }^\circ\text{C}$**

Parameter	Symbol	Values			Unit	Note or test condition
		Min.	Typ.	Max.		
Collector emitter breakdown voltage	$V_{(BR)CEO}$	4.5	5.5	–	V	$I_C = 1\text{ mA}$ , $I_B = 0$ , open base
Collector emitter leakage current	$I_{CES}$	–	–	10 <sup>2)</sup>	$\mu\text{A}$	$V_{CE} = 15\text{ V}$ , $V_{BE} = 0$ , $V_{CE} = 3\text{ V}$ , $V_{BE} = 0$ , E-B short circuited
			1	30 <sup>2)</sup>	nA	
Collector base leakage current	$I_{CBO}$		1	30 <sup>2)</sup>		$V_{CB} = 3\text{ V}$ , $I_E = 0$ , open emitter
Emitter base leakage current	$I_{EBO}$		10	100 <sup>2)</sup>		$V_{EB} = 0.5\text{ V}$ , $I_C = 0$ , open collector
DC current gain	$h_{FE}$	60	95	130		$V_{CE} = 4\text{ V}$ , $I_C = 5\text{ mA}$ , pulse measured

**3.2 General AC characteristics**

**Table 5 General AC characteristics at  $T_A = 25\text{ }^\circ\text{C}$**

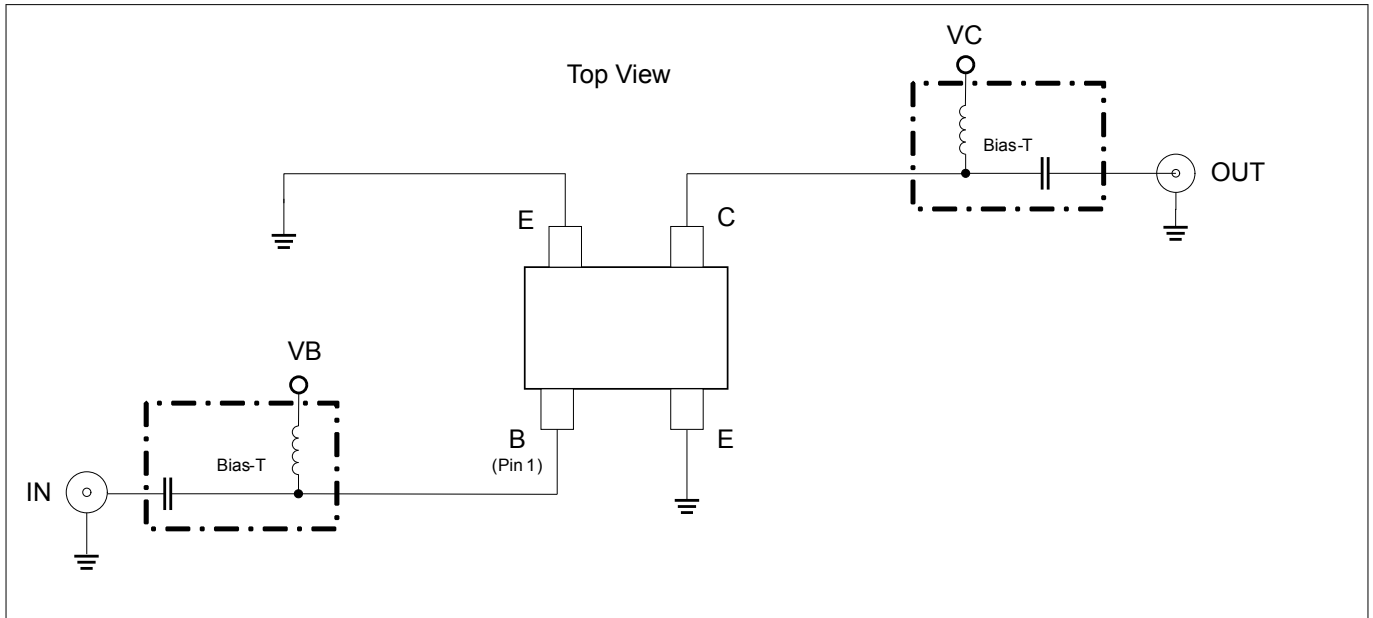
Parameter	Symbol	Values			Unit	Note or test condition
		Min.	Typ.	Max.		
Transition frequency	$f_T$	18	25	–	GHz	$V_{CE} = 3\text{ V}$ , $I_C = 30\text{ mA}$ , $f = 2\text{ GHz}$
Collector base capacitance	$C_{CB}$	–	0.15	0.3	pF	$V_{CB} = 2\text{ V}$ , $V_{BE} = 0$ , $f = 1\text{ MHz}$ , emitter grounded
Collector emitter capacitance	$C_{CE}$		0.46	–		$V_{CE} = 2\text{ V}$ , $V_{BE} = 0$ , $f = 1\text{ MHz}$ , base grounded
Emitter base capacitance	$C_{EB}$		0.55			$V_{EB} = 0.5\text{ V}$ , $V_{CB} = 0$ , $f = 1\text{ MHz}$ , collector grounded

<sup>2</sup> Maximum values not limited by the device but by the short cycle time of the 100% test.

**Electrical characteristics**

**3.3 Frequency dependent AC characteristics**

Measurement setup is a test fixture with Bias-T's in a 50 Ω system,  $T_A = 25\text{ °C}$ .



**Figure 2 Testing circuit**

**Table 6 AC characteristics,  $V_{CE} = 4\text{ V}$ ,  $f = 150\text{ MHz}$**

Parameter	Symbol	Values			Unit	Note or test condition
		Min.	Typ.	Max.		
Power gain		-		-	dB	$I_C = 40\text{ mA}$
<ul style="list-style-type: none"> <li>Maximum power gain</li> <li>Transducer gain</li> </ul>	$G_{ms}$ $ S_{21} ^2$		37 33			
Noise figure					dB	$V_{CE} = 3\text{ V}$ , $I_C = 4\text{ mA}$
<ul style="list-style-type: none"> <li>Minimum noise figure</li> <li>Associated gain</li> </ul>	$NF_{min}$ $G_{ass}$		0.9 24			
Linearity					dBm	$I_C = 40\text{ mA}$ , $Z_S = Z_L = 50\text{ }\Omega$
<ul style="list-style-type: none"> <li>3rd order intercept point at output</li> <li>1 dB gain compression point at output</li> </ul>	$OIP_3$ $OP_{1dB}$		25 15.5			

**Electrical characteristics**

**Table 7 AC characteristics,  $V_{CE} = 4\text{ V}$ ,  $f = 450\text{ MHz}$**

Parameter	Symbol	Values			Unit	Note or test condition
		Min.	Typ.	Max.		
Power gain	$G_{ms}$ $ S_{21} ^2$	-	31	-	dB	$I_C = 40\text{ mA}$
<ul style="list-style-type: none"> <li>Maximum power gain</li> <li>Transducer gain</li> </ul>			28.5			
Noise figure	$NF_{min}$ $G_{ass}$		0.9			$V_{CE} = 3\text{ V}$ , $I_C = 4\text{ mA}$
<ul style="list-style-type: none"> <li>Minimum noise figure</li> <li>Associated gain</li> </ul>			22.5			
Linearity	$OIP_3$ $OP_{1dB}$		26.5		dBm	$I_C = 40\text{ mA}$ , $Z_S = Z_L = 50\ \Omega$
<ul style="list-style-type: none"> <li>3rd order intercept point at output</li> <li>1 dB gain compression point at output</li> </ul>			16.5			

**Table 8 AC characteristics,  $V_{CE} = 4\text{ V}$ ,  $f = 900\text{ MHz}$**

Parameter	Symbol	Values			Unit	Note or test condition
		Min.	Typ.	Max.		
Power gain	$G_{ms}$ $ S_{21} ^2$	-	26.5	-	dB	$I_C = 40\text{ mA}$
<ul style="list-style-type: none"> <li>Maximum power gain</li> <li>Transducer gain</li> </ul>			24			
Noise figure	$NF_{min}$ $G_{ass}$		0.95			$V_{CE} = 3\text{ V}$ , $I_C = 4\text{ mA}$
<ul style="list-style-type: none"> <li>Minimum noise figure</li> <li>Associated gain</li> </ul>			20			
Linearity	$OIP_3$ $OP_{1dB}$		27.5		dBm	$I_C = 40\text{ mA}$ , $Z_S = Z_L = 50\ \Omega$
<ul style="list-style-type: none"> <li>3rd order intercept point at output</li> <li>1 dB gain compression point at output</li> </ul>			17			

**Table 9 AC characteristics,  $V_{CE} = 4\text{ V}$ ,  $f = 1.5\text{ GHz}$**

Parameter	Symbol	Values			Unit	Note or test condition
		Min.	Typ.	Max.		
Power gain	$G_{ma}$ $ S_{21} ^2$	-	22	-	dB	$I_C = 40\text{ mA}$
<ul style="list-style-type: none"> <li>Maximum power gain</li> <li>Transducer gain</li> </ul>			19.5			
Noise figure	$NF_{min}$ $G_{ass}$		1			$V_{CE} = 3\text{ V}$ , $I_C = 4\text{ mA}$
<ul style="list-style-type: none"> <li>Minimum noise figure</li> <li>Associated gain</li> </ul>			16.5			
Linearity	$OIP_3$ $OP_{1dB}$		27.5		dBm	$I_C = 40\text{ mA}$ , $Z_S = Z_L = 50\ \Omega$
<ul style="list-style-type: none"> <li>3rd order intercept point at output</li> <li>1 dB gain compression point at output</li> </ul>			16			

**Electrical characteristics**

**Table 10 AC characteristics,  $V_{CE} = 4\text{ V}$ ,  $f = 1.9\text{ GHz}$**

Parameter	Symbol	Values			Unit	Note or test condition
		Min.	Typ.	Max.		
Power gain	$G_{ma}$ $ S_{21} ^2$	-	19	-	dB	$I_C = 40\text{ mA}$
<ul style="list-style-type: none"> <li>Maximum power gain</li> <li>Transducer gain</li> </ul>						
Noise figure	$NF_{min}$ $G_{ass}$		1.1	15		$V_{CE} = 3\text{ V}$ , $I_C = 4\text{ mA}$
<ul style="list-style-type: none"> <li>Minimum noise figure</li> <li>Associated gain</li> </ul>						
Linearity	$OIP_3$ $OP_{1dB}$		28	17	dBm	$I_C = 40\text{ mA}$ , $Z_S = Z_L = 50\ \Omega$
<ul style="list-style-type: none"> <li>3rd order intercept point at output</li> <li>1 dB gain compression point at output</li> </ul>						

**Table 11 AC characteristics,  $V_{CE} = 4\text{ V}$ ,  $f = 2.4\text{ GHz}$**

Parameter	Symbol	Values			Unit	Note or test condition
		Min.	Typ.	Max.		
Power gain	$G_{ma}$ $ S_{21} ^2$	-	16.5	-	dB	$I_C = 40\text{ mA}$
<ul style="list-style-type: none"> <li>Maximum power gain</li> <li>Transducer gain</li> </ul>						
Noise figure	$NF_{min}$ $G_{ass}$		1.2	12.5		$V_{CE} = 3\text{ V}$ , $I_C = 4\text{ mA}$
<ul style="list-style-type: none"> <li>Minimum noise figure</li> <li>Associated gain</li> </ul>						
Linearity	$OIP_3$ $OP_{1dB}$		28	16.5	dBm	$I_C = 40\text{ mA}$ , $Z_S = Z_L = 50\ \Omega$
<ul style="list-style-type: none"> <li>3rd order intercept point at output</li> <li>1 dB gain compression point at output</li> </ul>						

**Table 12 AC characteristics,  $V_{CE} = 4\text{ V}$ ,  $f = 3.5\text{ GHz}$**

Parameter	Symbol	Values			Unit	Note or test condition
		Min.	Typ.	Max.		
Power gain	$G_{ma}$ $ S_{21} ^2$	-	13	-	dB	$I_C = 40\text{ mA}$
<ul style="list-style-type: none"> <li>Maximum power gain</li> <li>Transducer gain</li> </ul>						
Noise figure	$NF_{min}$ $G_{ass}$		1.6	10		$V_{CE} = 3\text{ V}$ , $I_C = 4\text{ mA}$
<ul style="list-style-type: none"> <li>Minimum noise figure</li> <li>Associated gain</li> </ul>						
Linearity	$OIP_3$ $OP_{1dB}$		26	17	dBm	$I_C = 40\text{ mA}$ , $Z_S = Z_L = 50\ \Omega$
<ul style="list-style-type: none"> <li>3rd order intercept point at output</li> <li>1 dB gain compression point at output</li> </ul>						



**Electrical characteristics**

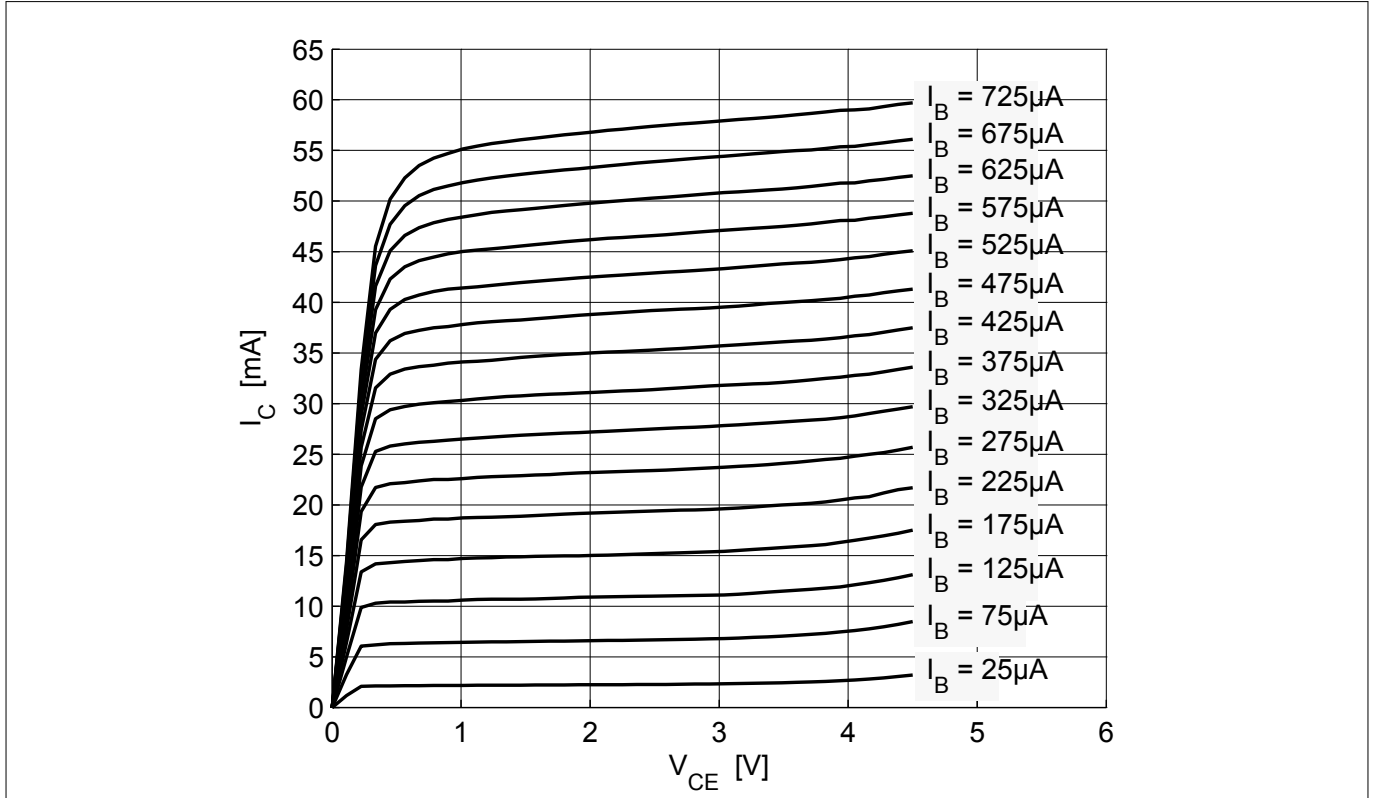
**Table 13 AC characteristics,  $V_{CE} = 4\text{ V}$ ,  $f = 5.5\text{ GHz}$**

Parameter	Symbol	Values			Unit	Note or test condition
		Min.	Typ.	Max.		
Power gain		-		-	dB	$I_C = 40\text{ mA}$
<ul style="list-style-type: none"> <li>Maximum power gain</li> <li>Transducer gain</li> </ul>	$G_{ma}$ $ S_{21} ^2$		 9 8			
Noise figure						$V_{CE} = 3\text{ V}$ , $I_C = 4\text{ mA}$
<ul style="list-style-type: none"> <li>Minimum noise figure</li> <li>Associated gain</li> </ul>	$NF_{min}$ $G_{ass}$	 2.2 5				
Linearity					dBm	$I_C = 40\text{ mA}$ , $Z_S = Z_L = 50\ \Omega$
<ul style="list-style-type: none"> <li>3rd order intercept point at output</li> <li>1 dB gain compression point at output</li> </ul>	$OIP_3$ $OP_{1dB}$	 26 17				

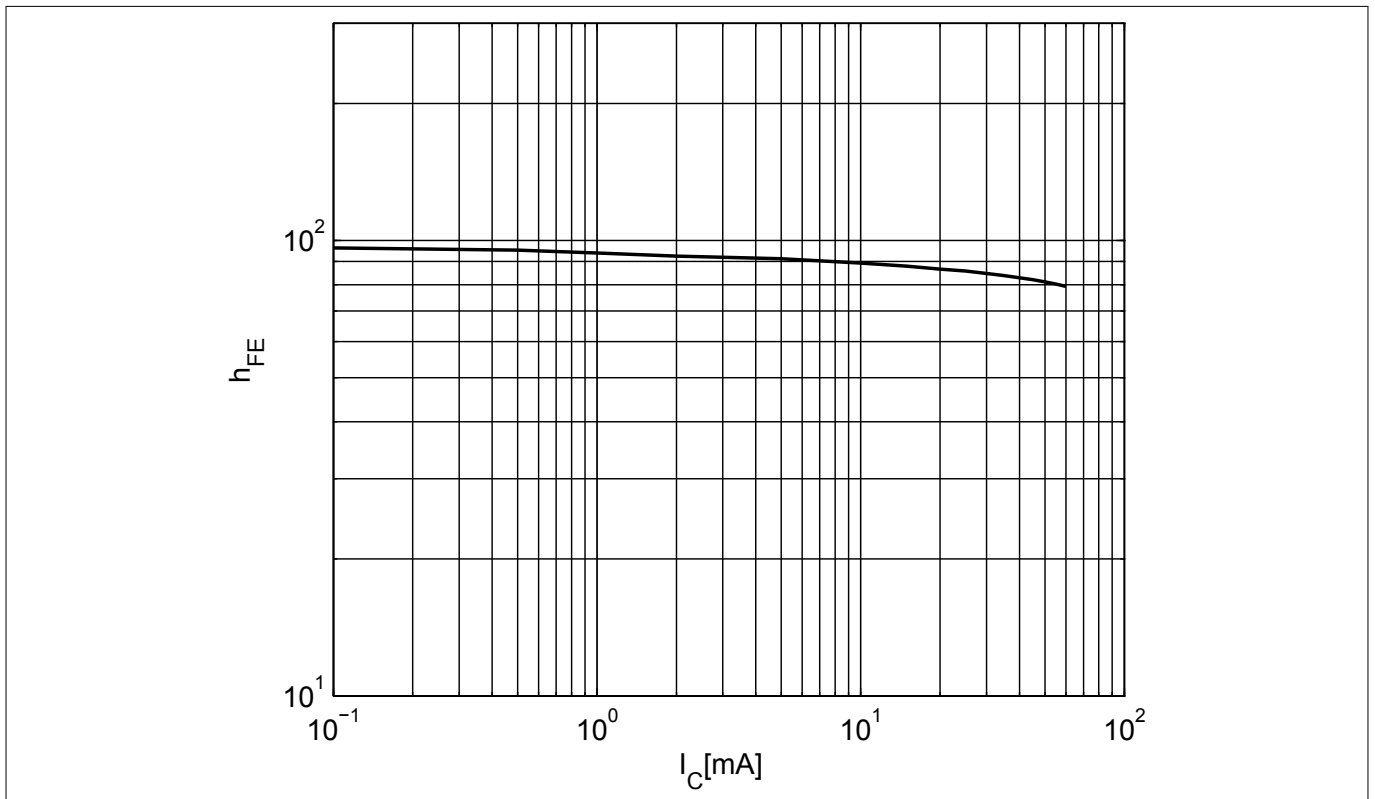
Note:  $G_{ms} = |S_{21}/S_{12}|$  for  $k < 1$ ;  $G_{ma} = |S_{21}/S_{12}|(k-(k^2-1)^{1/2})$  for  $k > 1$ . In order to get the  $NF_{min}$  values stated in this chapter, the test fixture losses have been subtracted from all measured results.  $OIP_3$  value depends on termination of all intermodulation frequency components. Termination used for this measurement is  $50\ \Omega$  from 0.2 MHz to 12 GHz.

Electrical characteristics

**3.4 Characteristic DC diagrams**

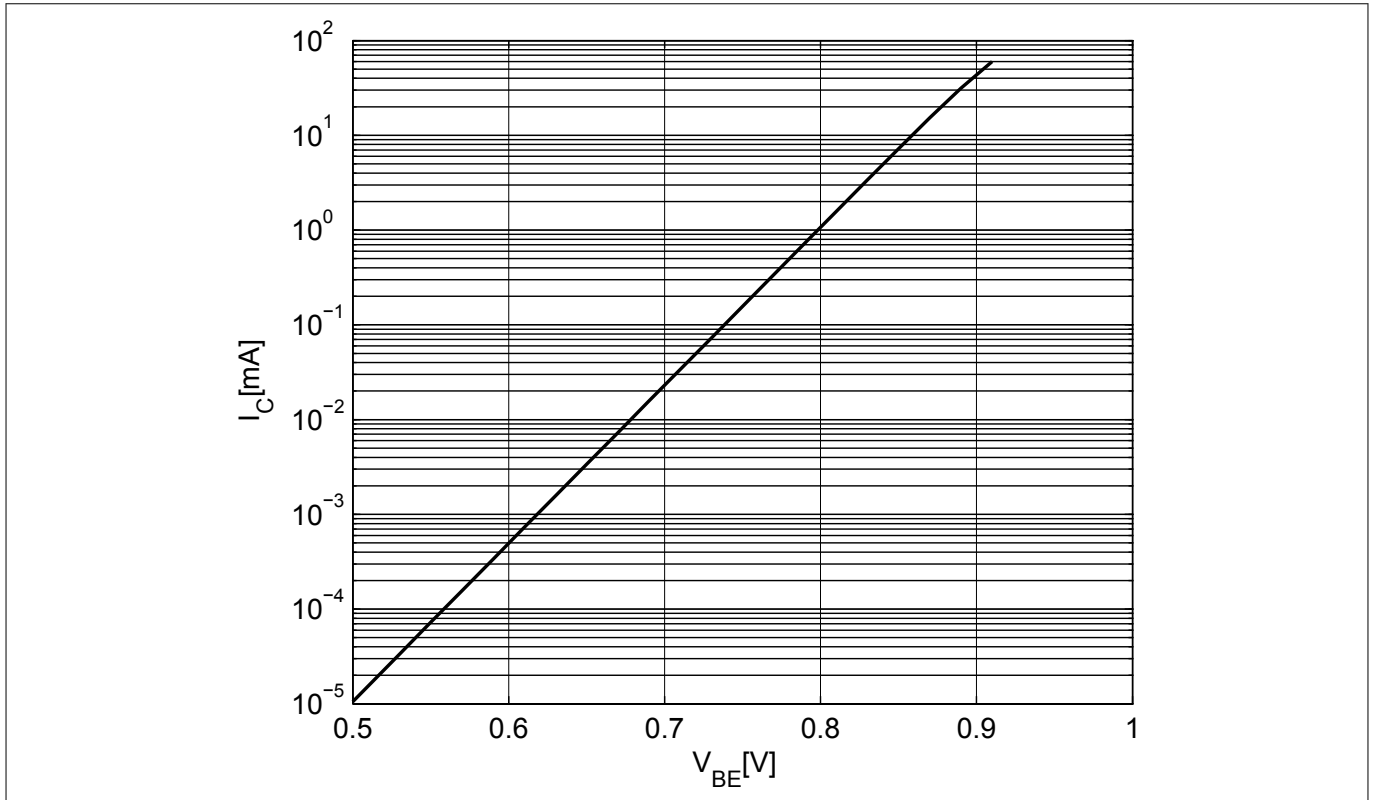


**Figure 3** Collector current vs. collector emitter voltage  $I_C = f(V_{CE})$ ,  $I_B = \text{parameter}$

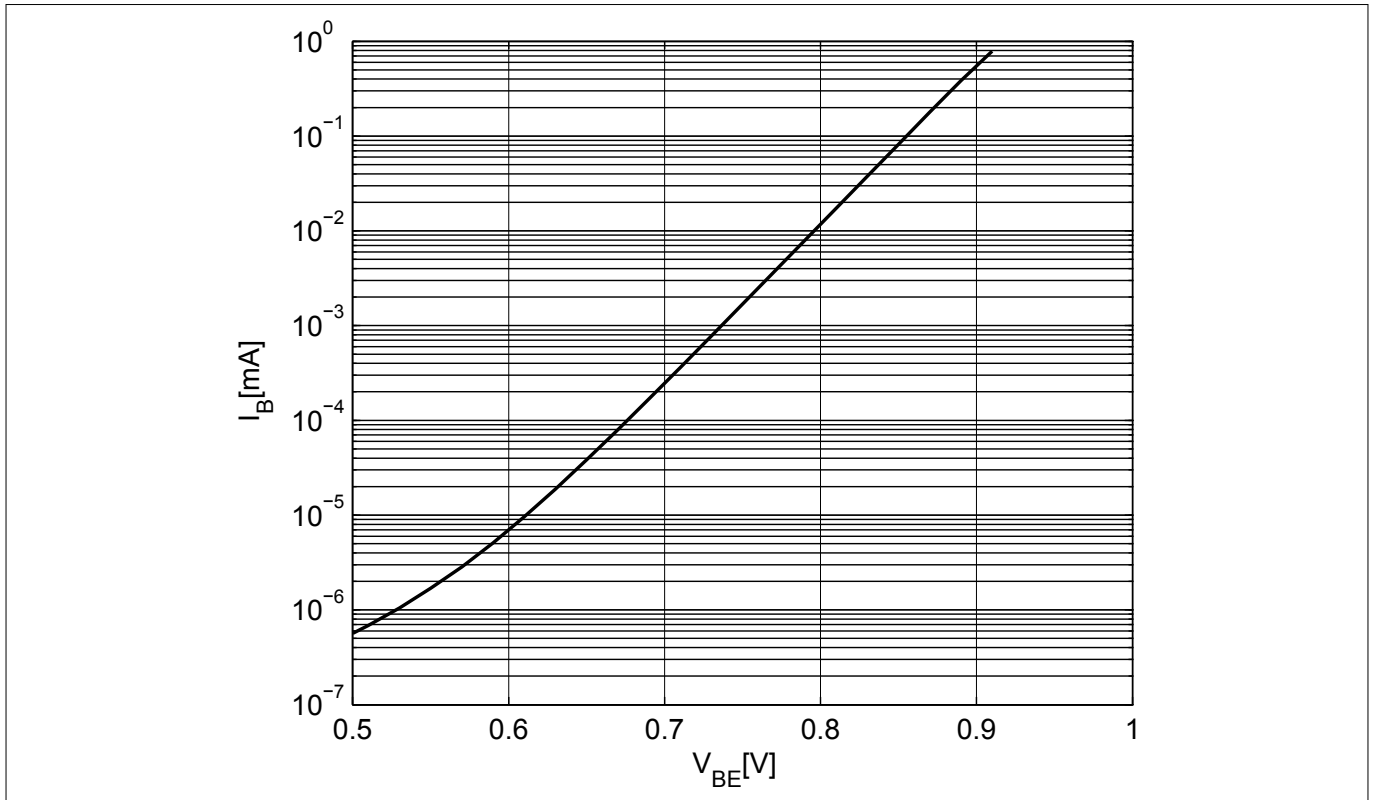


**Figure 4** DC current gain  $h_{FE} = f(I_C)$ ,  $V_{CE} = 3 V$

**Electrical characteristics**

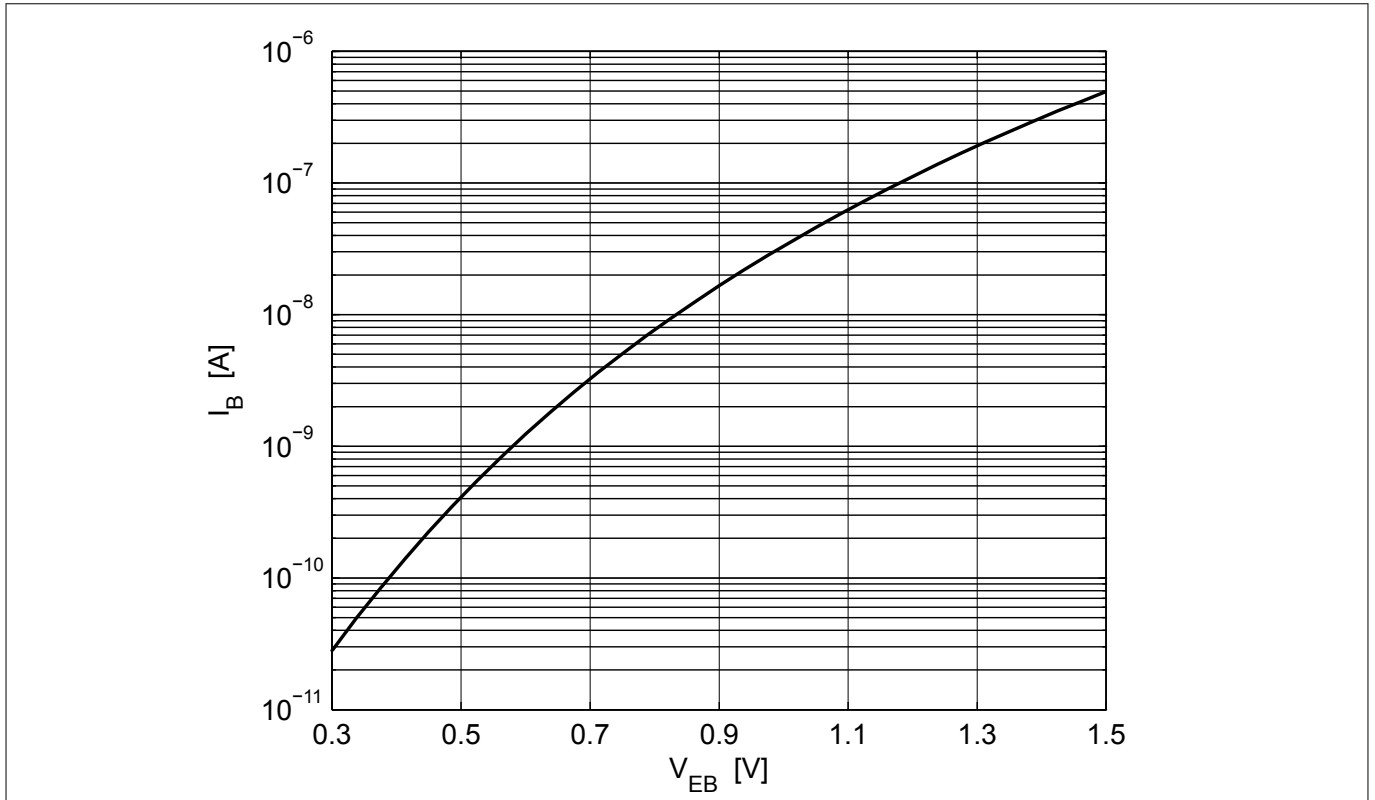


**Figure 5** Collector current vs. base emitter forward voltage  $I_C = f(V_{BE})$ ,  $V_{CE} = 3\text{ V}$

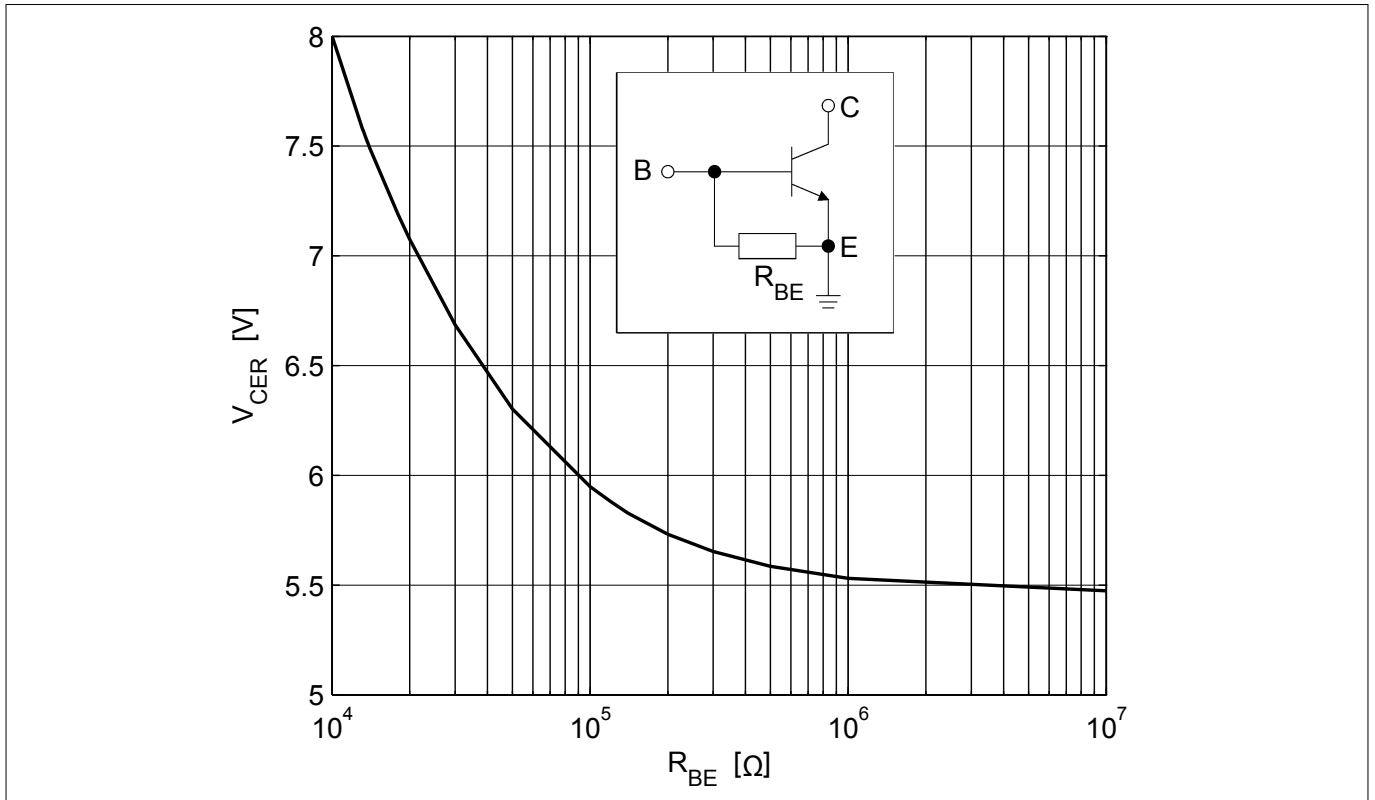


**Figure 6** Base current vs. base emitter forward voltage  $I_B = f(V_{BE})$ ,  $V_{CE} = 3\text{ V}$

**Electrical characteristics**



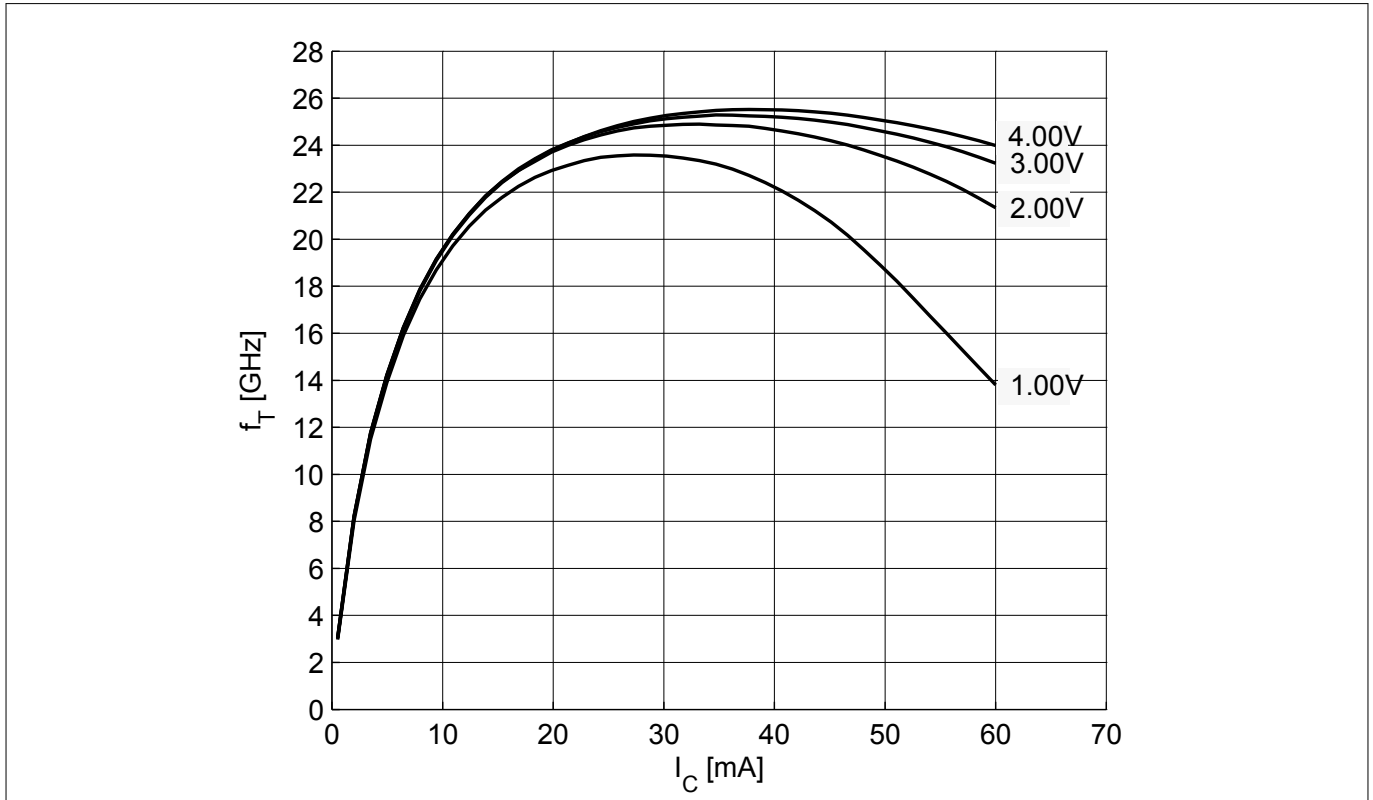
**Figure 7** Base current vs. base emitter reverse voltage  $I_B = f(V_{EB})$ ,  $V_{CE} = 3\text{ V}$



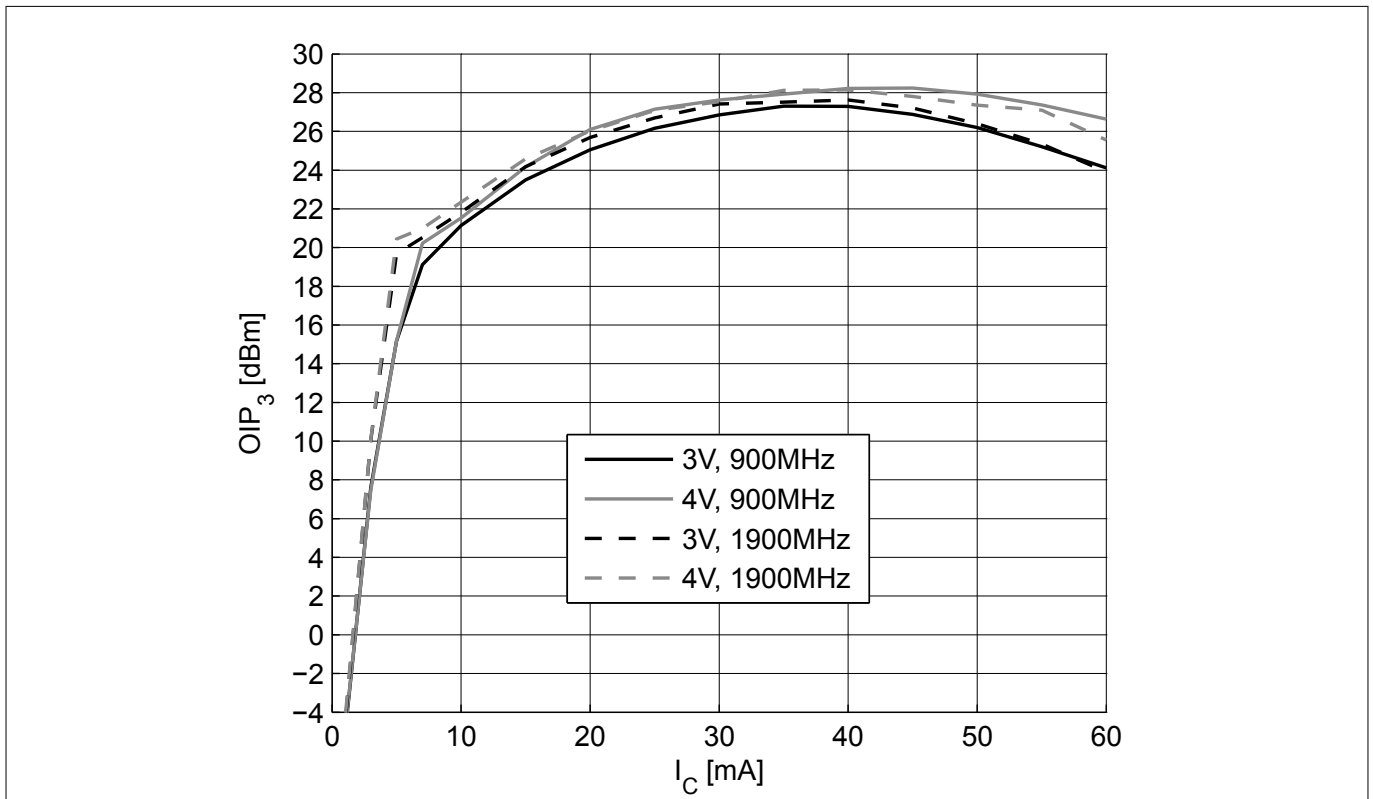
**Figure 8** Collector emitter breakdown voltage  $V_{CER} = f(R_{BE})$ ,  $I_C = 1\text{ mA}$

Electrical characteristics

**3.5 Characteristic AC diagrams**

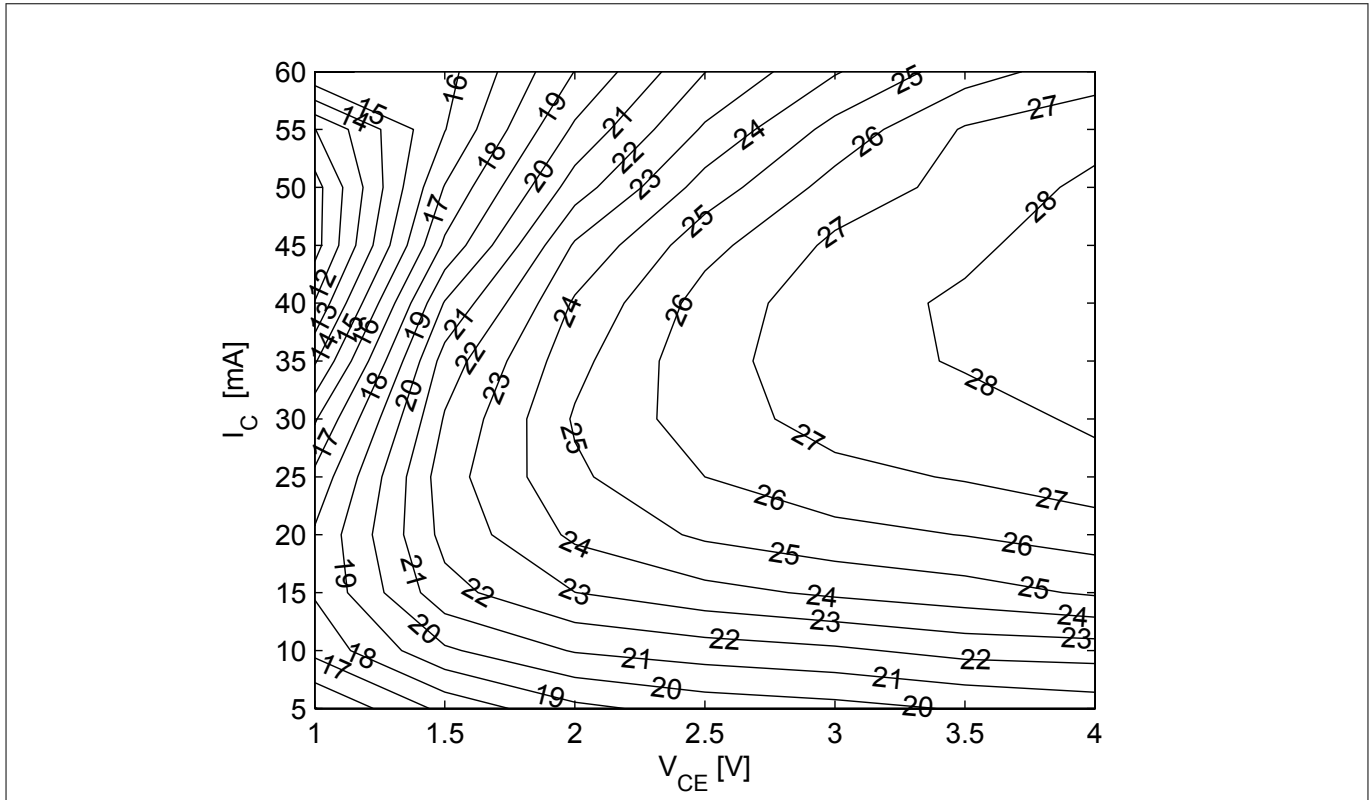


**Figure 9** Transition frequency  $f_T = f(I_C)$ ,  $f = 2 \text{ GHz}$ ,  $V_{CE} = \text{parameter}$

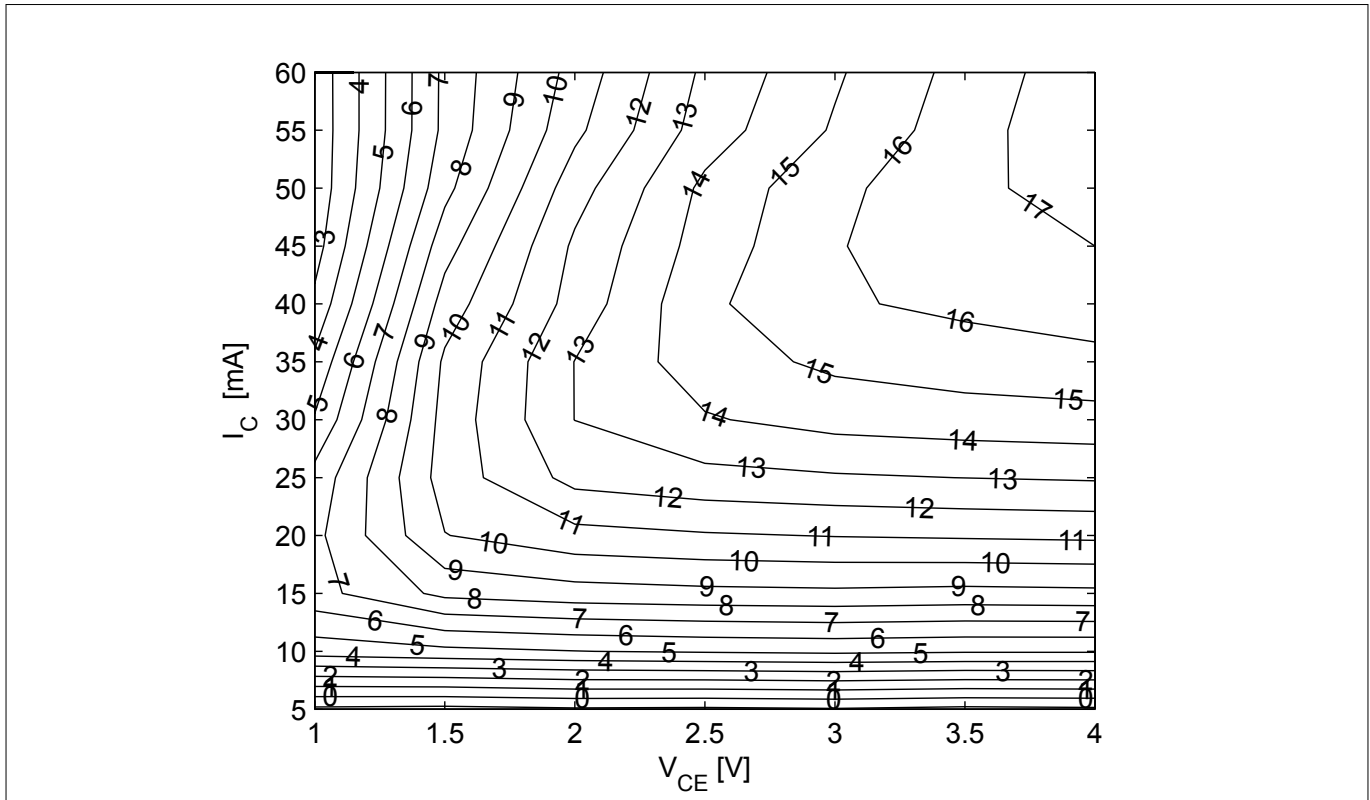


**Figure 10** 3rd order intercept point  $OIP_3 = f(I_C)$ ,  $Z_S = Z_L = 50 \Omega$ ,  $V_{CE}$ ,  $f = \text{parameters}$

**Electrical characteristics**

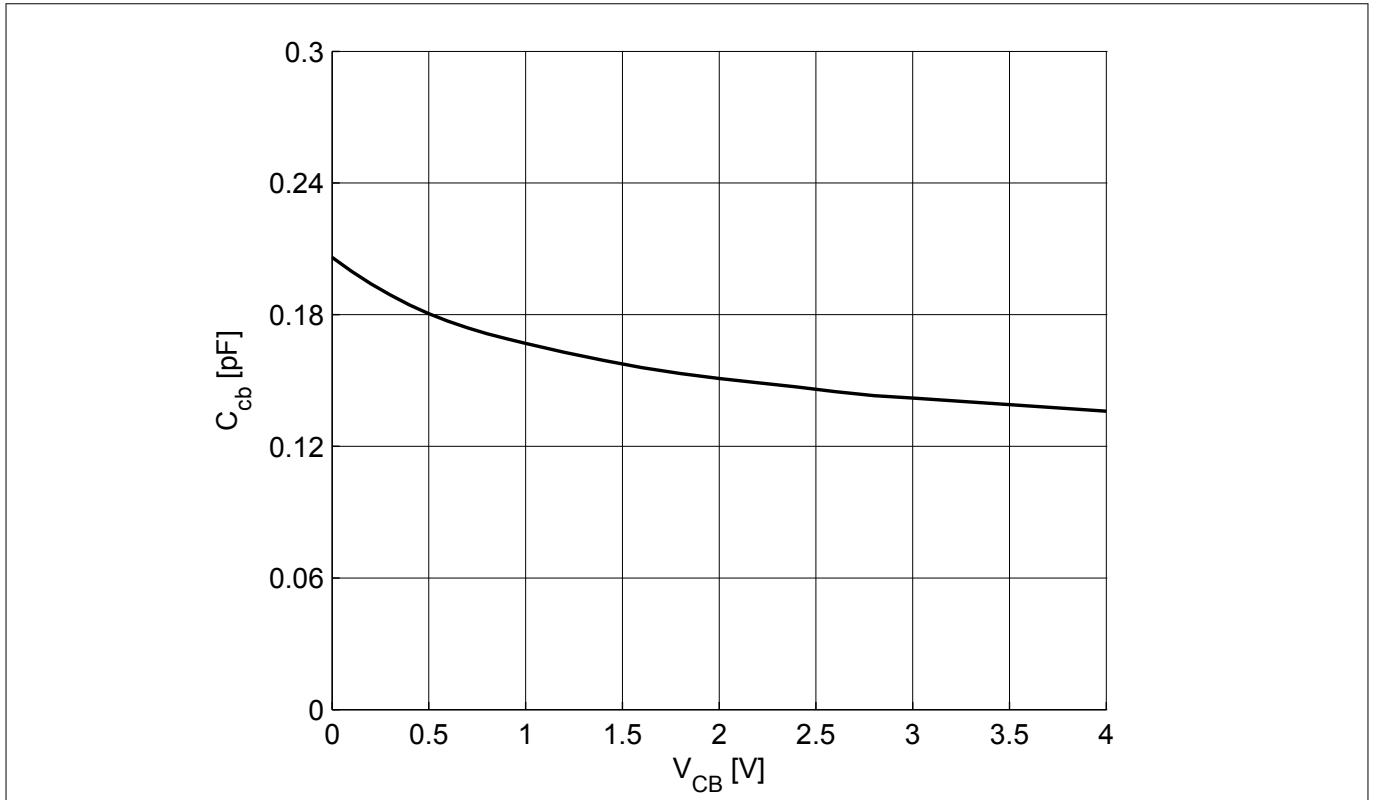


**Figure 11** 3rd order intercept point at output  $OIP_3$  [dBm] =  $f(I_C, V_{CE})$ ,  $Z_S = Z_L = 50 \Omega$ ,  $f = 1.9$  GHz

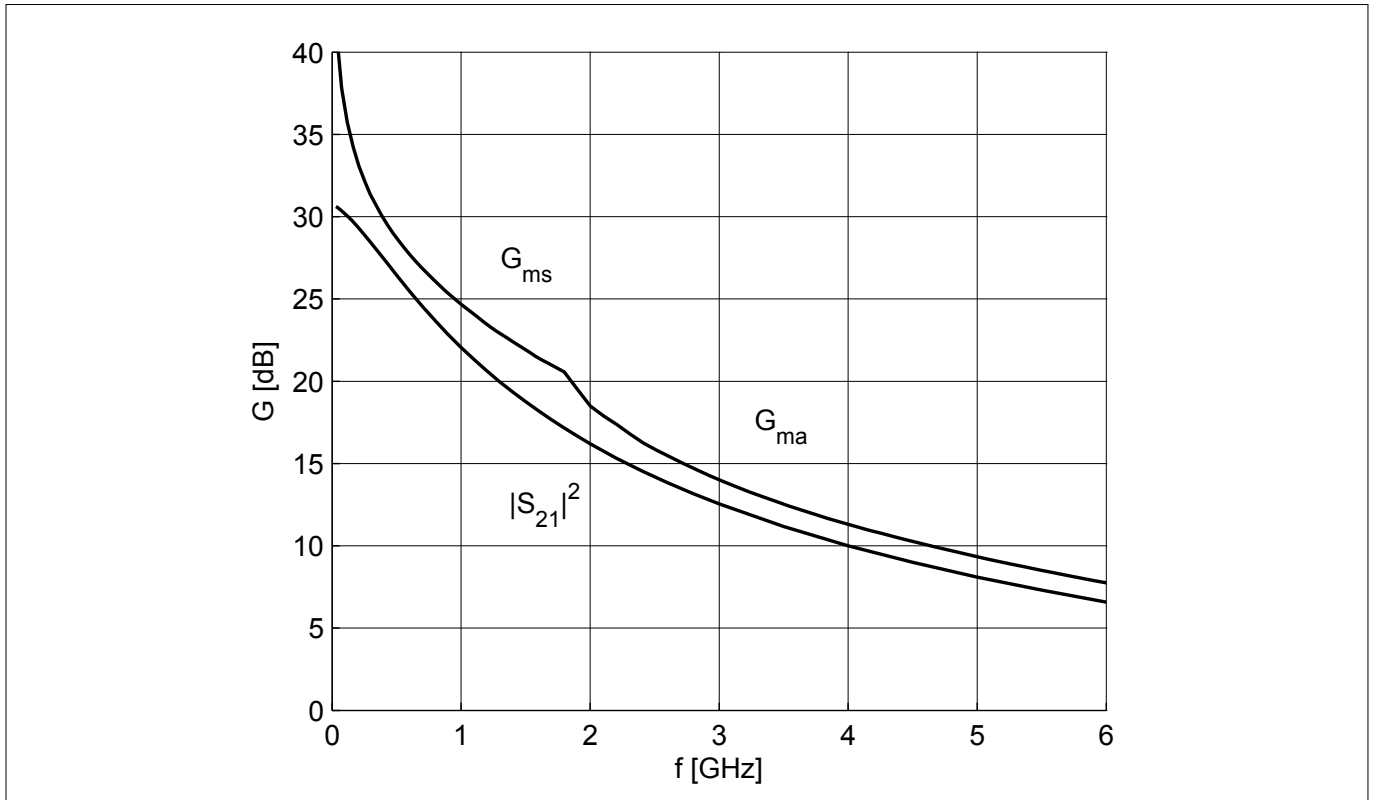


**Figure 12** Compression point at output  $OP_{1dB}$  [dBm] =  $f(I_C, V_{CE})$ ,  $Z_S = Z_L = 50 \Omega$ ,  $f = 1.9$  GHz

**Electrical characteristics**

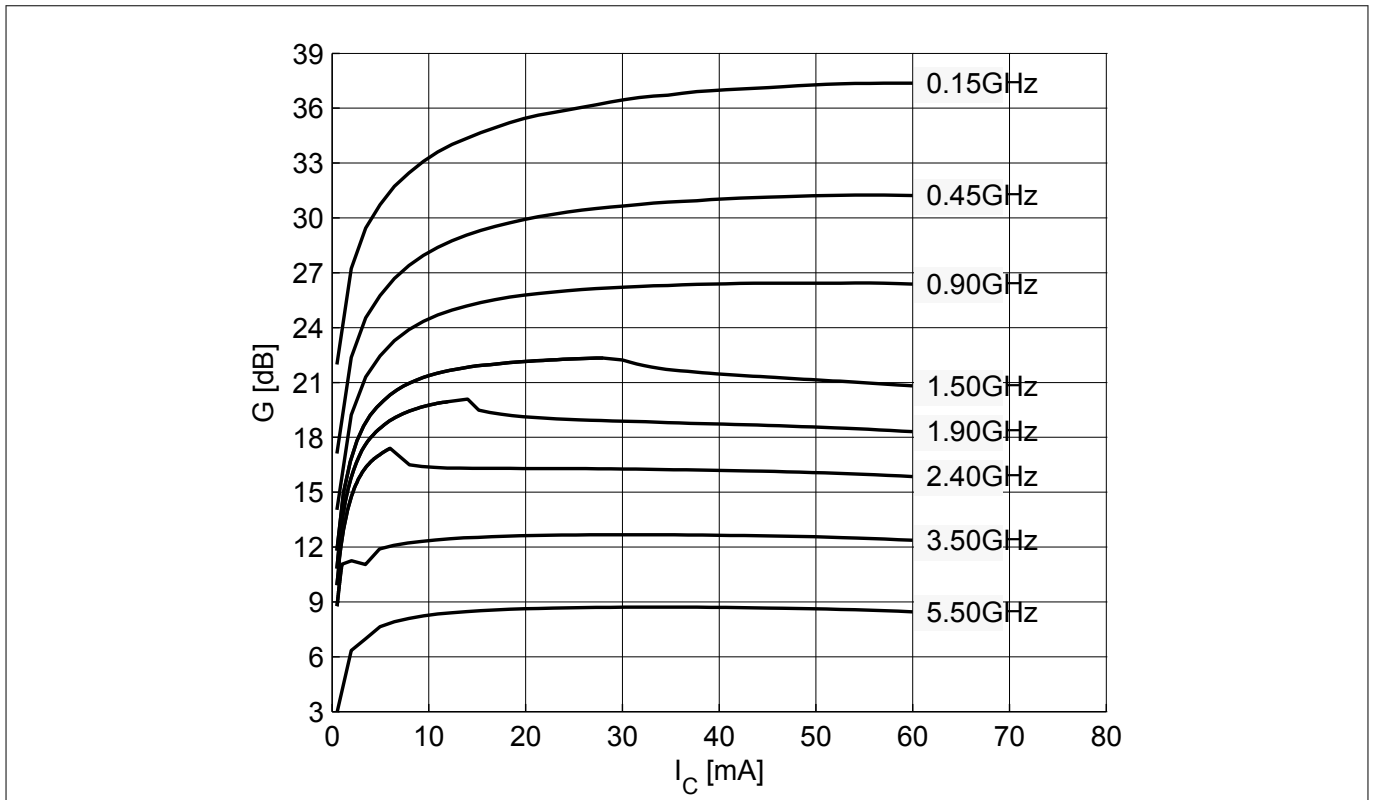


**Figure 13** Collector base capacitance  $C_{CB} = f(V_{CB}), f = 1 \text{ MHz}$

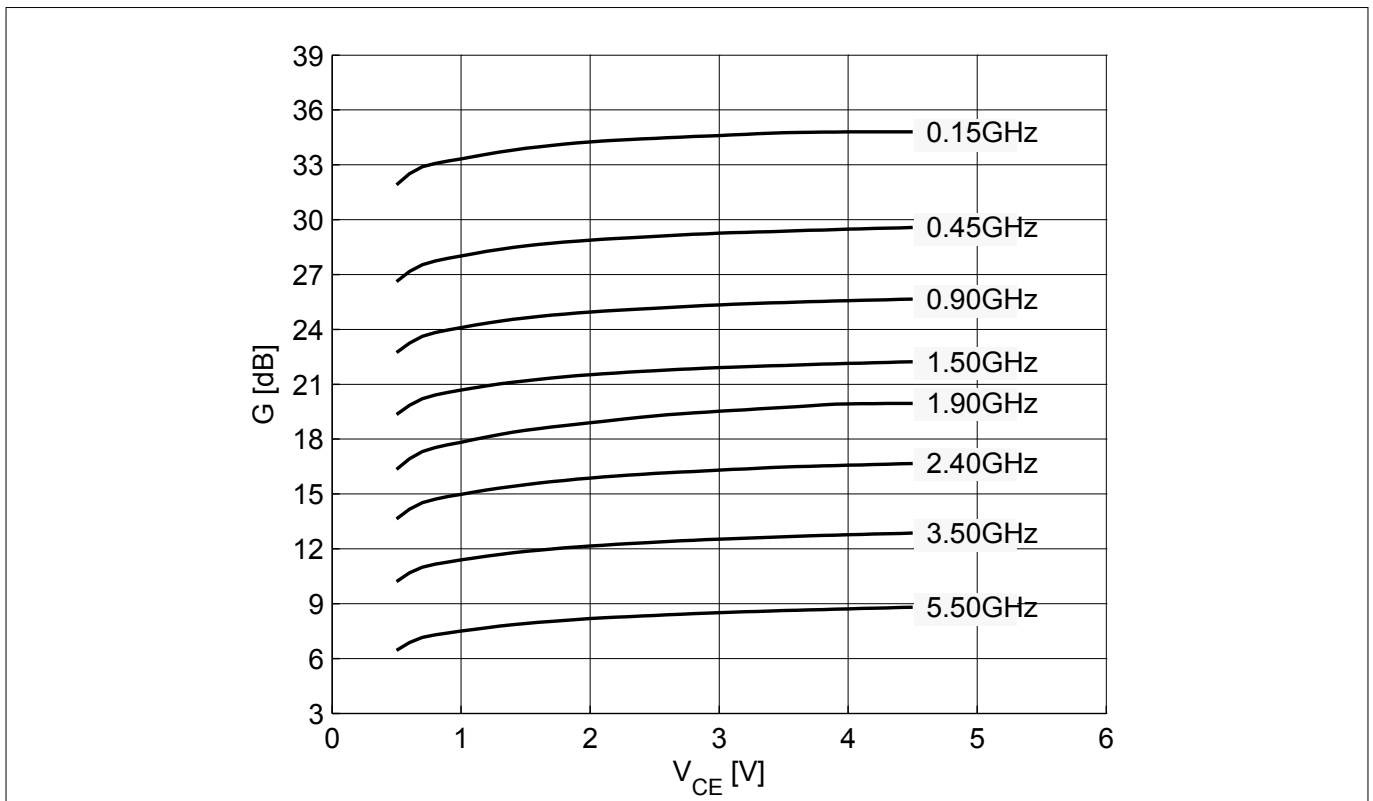


**Figure 14** Gain  $G_{ma}, G_{ms}, |S_{21}|^2 = f(f), V_{CE} = 3 \text{ V}, I_C = 15 \text{ mA}$

**Electrical characteristics**



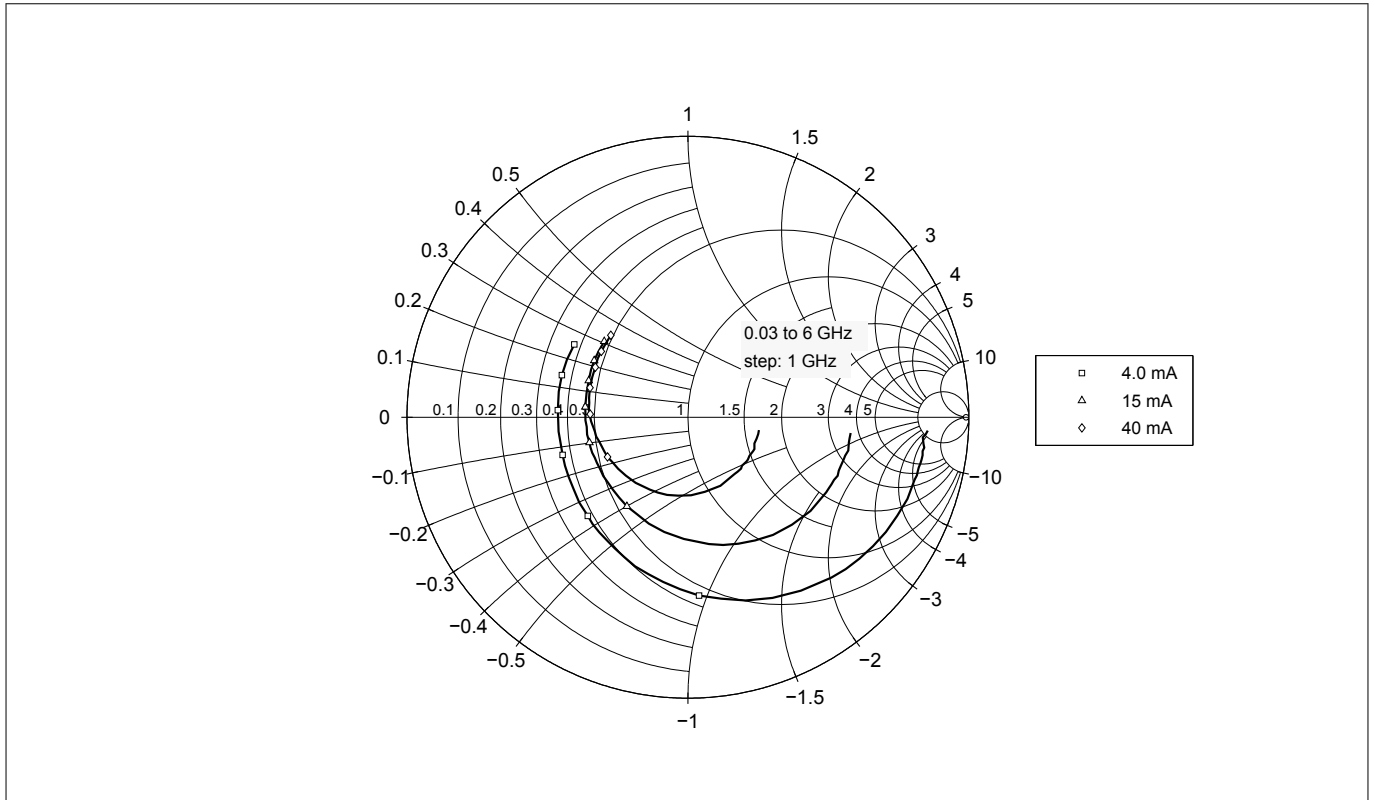
**Figure 15** Maximum power gain  $G_{max} = f(I_C)$ ,  $V_{CE} = 3\text{ V}$ ,  $f = \text{parameter in GHz}$



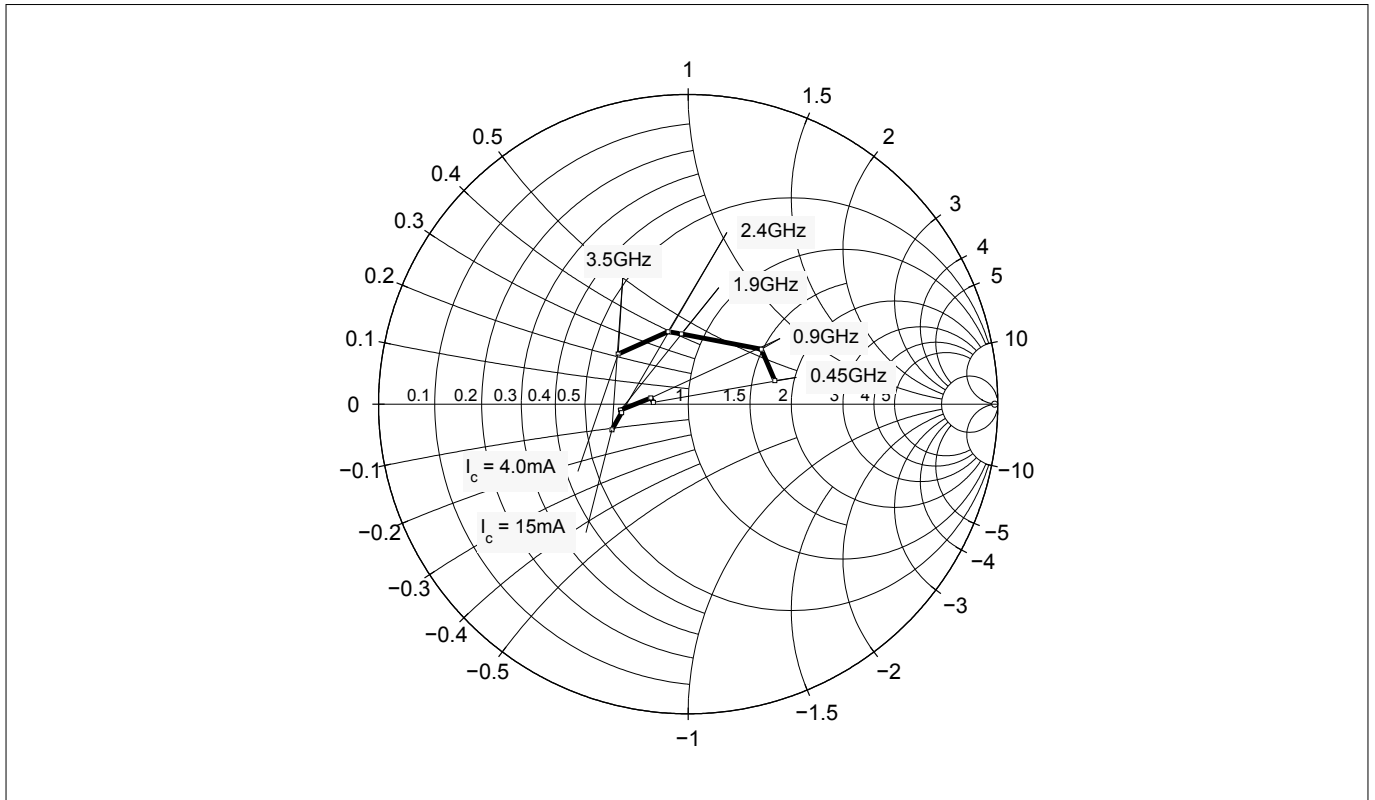
**Figure 16** Maximum power gain  $G_{max} = f(V_{CE})$ ,  $I_C = 15\text{ mA}$ ,  $f = \text{parameter in GHz}$



**Electrical characteristics**

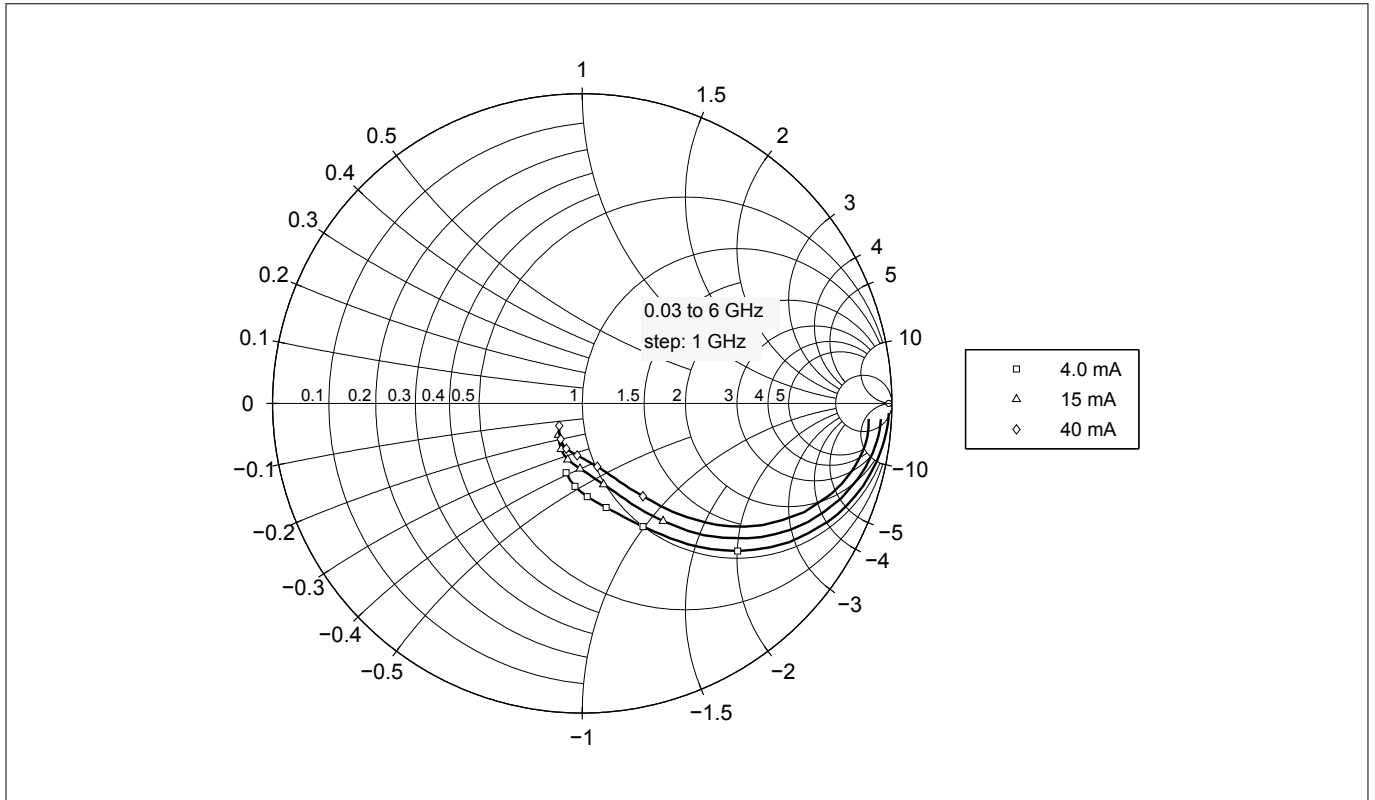


**Figure 17** Input reflection coefficient  $S_{11} = f(f)$ ,  $V_{CE} = 3\text{ V}$ ,  $I_C = 4 / 15 / 40\text{ mA}$

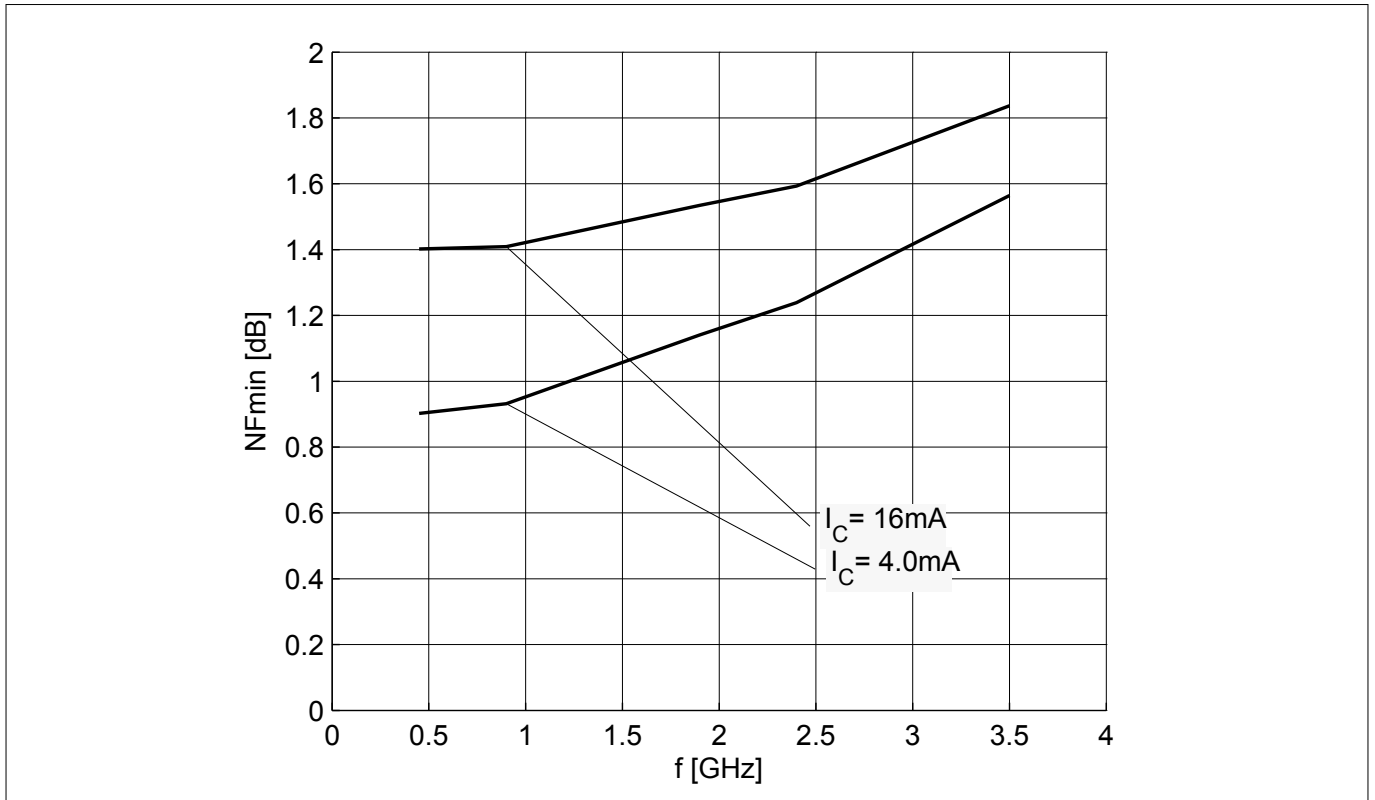


**Figure 18** Source impedance for minimum noise figure  $Z_{S,opt} = f(f)$ ,  $V_{CE} = 3\text{ V}$ ,  $I_C = 4 / 15\text{ mA}$

**Electrical characteristics**

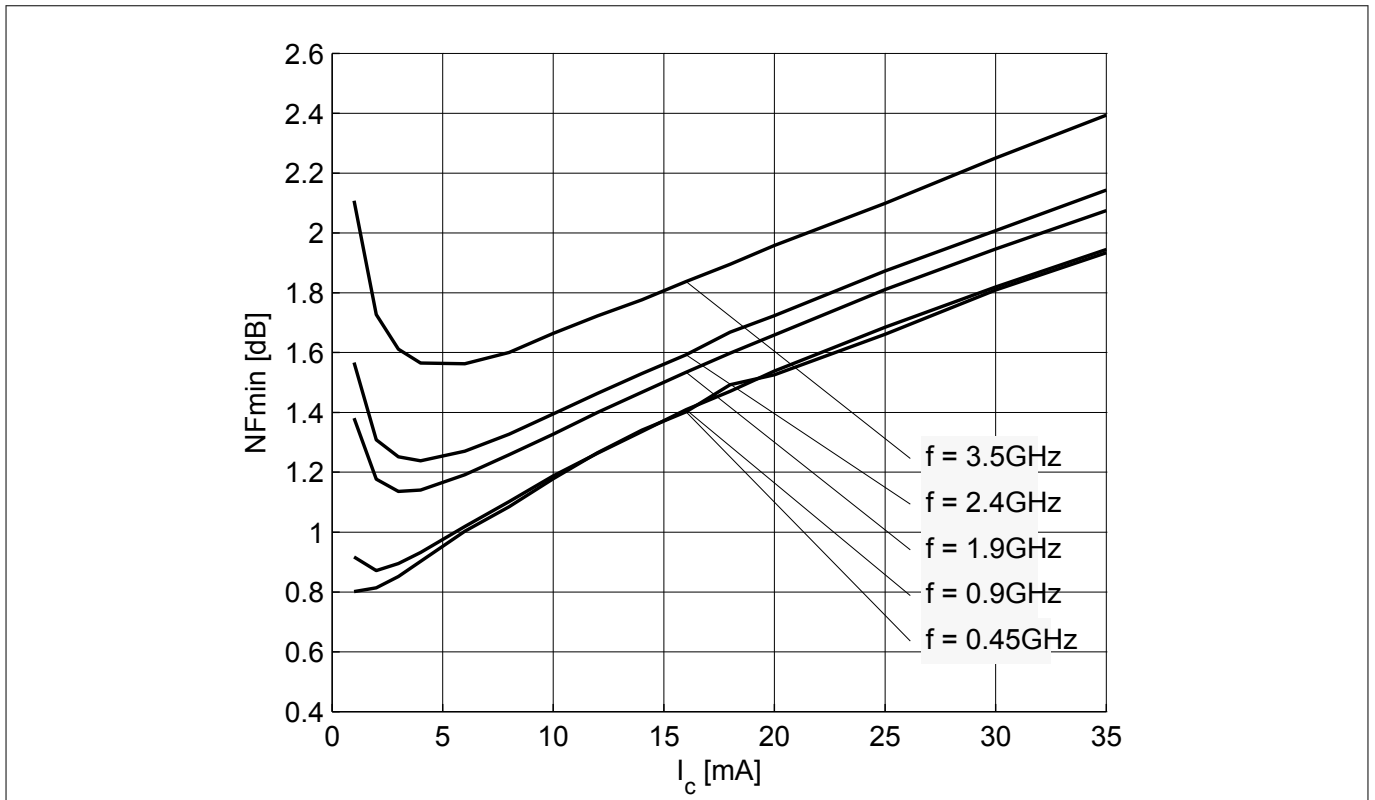


**Figure 19** Output reflection coefficient  $S_{22} = f(f)$ ,  $V_{CE} = 3\text{ V}$ ,  $I_C = 4 / 15 / 40\text{ mA}$

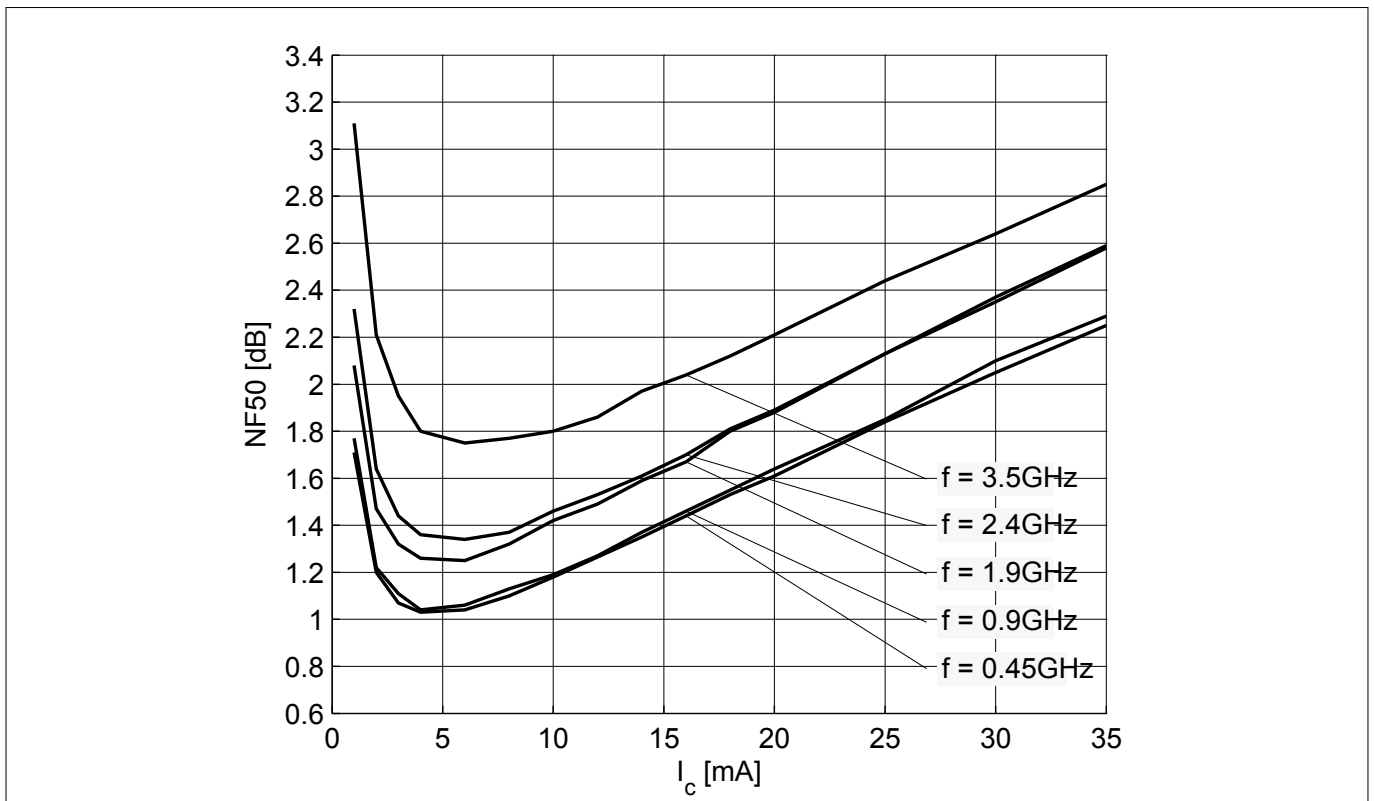


**Figure 20** Noise figure  $NF_{min} = f(f)$ ,  $V_{CE} = 3\text{ V}$ ,  $Z_S = Z_{S,opt}$ ,  $I_C = 4 / 16\text{ mA}$

**Electrical characteristics**



**Figure 21** Noise figure  $NF_{min} = f(I_C)$ ,  $V_{CE} = 3\text{ V}$ ,  $Z_S = Z_{S,opt}$ ,  $f = \text{parameter in GHz}$

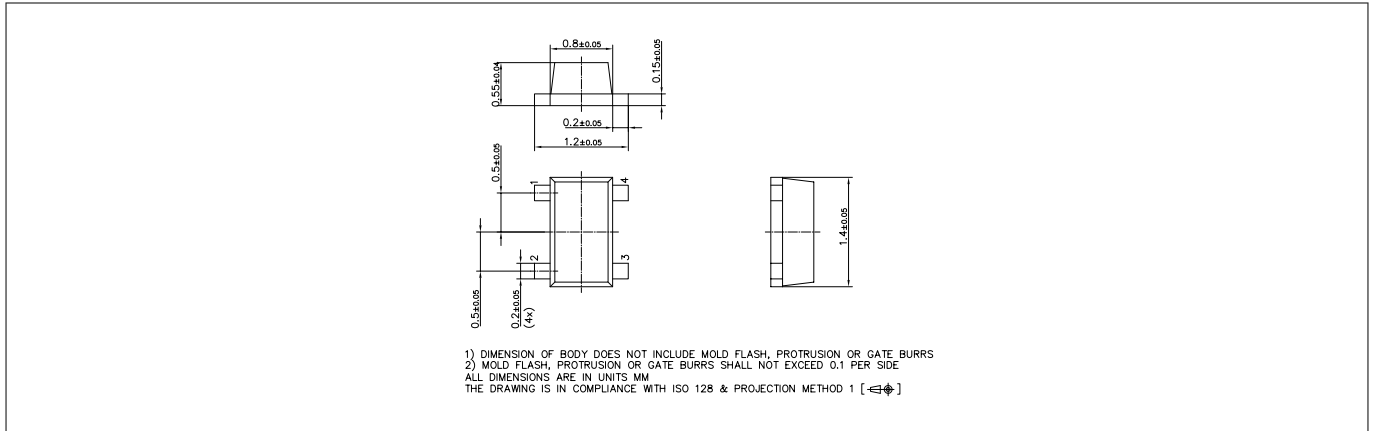


**Figure 22** Noise figure  $NF_{50} = f(I_C)$ ,  $V_{CE} = 3\text{ V}$ ,  $Z_S = 50\ \Omega$ ,  $f = \text{parameter in GHz}$

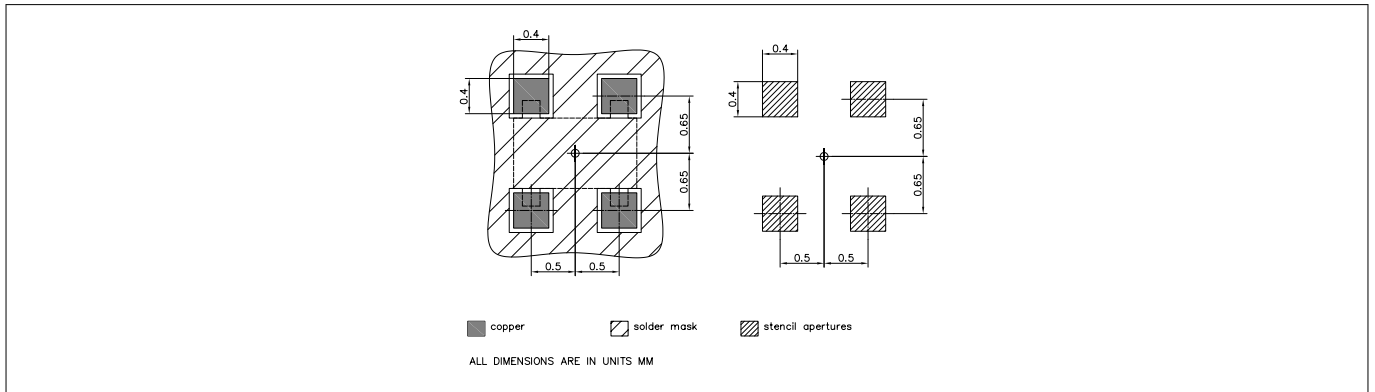
*Note:* The curves shown in this chapter have been generated using typical devices but shall not be considered as a guarantee that all devices have identical characteristic curves.  $T_A = 25\ ^\circ\text{C}$ .

**Package information TSFP-4-1**

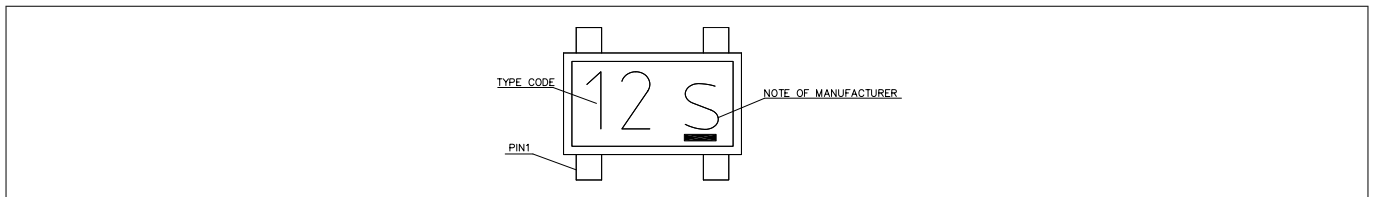
**4 Package information TSFP-4-1**



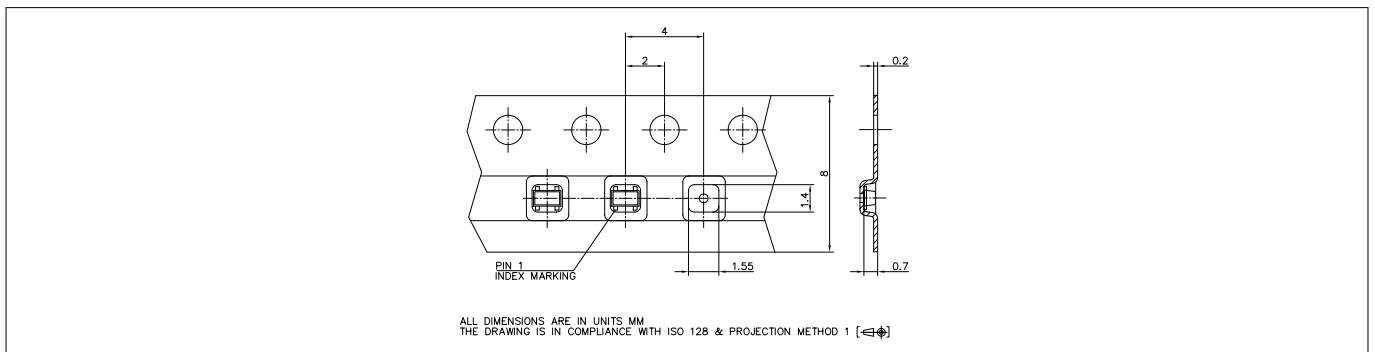
**Figure 23 Package outline**



**Figure 24 Foot print**



**Figure 25 Marking layout example**



**Figure 26 Tape dimensions**

---

Revision history

## Revision history

Document version	Date of release	Description of changes
Revision 2.0	2019-01-25	New datasheet layout.