

BFP540ESD

Surface mount robust silicon NPN RF bipolar transistor



Product description

The BFP540ESD is a low noise device based on a grounded emitter (SIEGET™) that is part of Infineon's established fifth generation RF bipolar transistor family. Its ESD structure provides high robustness. It remains cost competitive without compromising on ease of use.



Feature list

- Minimum noise figure $NF_{min} = 0.9$ dB at 1.8 GHz, 2 V, 5 mA
- High gain $G_{ms} = 21.5$ dB at 1.8 GHz, 2 V, 20 mA
- $OIP_3 = 24.5$ dBm at 1.8 GHz, 2 V, 20 mA
- High ESD robustness, typical 1 kV (HBM)

Product validation

Qualified for industrial applications according to the relevant tests of JEDEC47/20/22.

Potential applications

- Radio-frequency oscillators such as local oscillator in LNB
- Broadband low noise amplifiers (LNAs) for CATV, DVB-T, DAB/DMB and FM/AM radio
- LNAs for wireless communications such as cordless phones

Device information

Table 1 Part information

Product name / Ordering code	Package	Pin configuration				Marking	Pieces / Reel
BFP540ESD / BFP540ESDH6327XTSA1	SOT343	1 = B	2 = E	3 = C	4 = E	AUs	3000

Attention: ESD (Electrostatic discharge) sensitive device, observe handling precautions

Table of contents

Table of contents

	Product description	1
	Feature list	1
	Product validation	1
	Potential applications	1
	Device information	1
	Table of contents	2
1	Absolute maximum ratings	3
2	Thermal characteristics	4
3	Electrical characteristics	6
3.1	DC characteristics	6
3.2	General AC characteristics	6
3.3	Frequency dependent AC characteristics	7
3.4	Characteristic AC diagrams	8
4	Package information SOT343	13
	Revision history	14
	Disclaimer	15

Absolute maximum ratings

1 Absolute maximum ratings

Table 2 Absolute maximum ratings at $T_A = 25\text{ °C}$ (unless otherwise specified)

Parameter	Symbol	Values		Unit	Note or test condition
		Min.	Max.		
Collector emitter voltage	V_{CEO}	-	4.5	V	Open base
			4		$T_A = -55\text{ °C}$, open base
Collector emitter voltage	V_{CES}		10		E-B short circuited
Collector base voltage	V_{CBO}		10		Open emitter
Emitter base voltage	V_{EBO}		1		Open collector
Base current	I_B		8	mA	-
Collector current	I_C		80		
Total power dissipation ¹⁾	P_{tot}		250	mW	$T_S \leq 77\text{ °C}$
Junction temperature	T_J		150	°C	-
Ambient temperature	T_A		-55		
Storage temperature	T_{Stg}				

Attention: *Stresses above the max. values listed here may cause permanent damage to the device. Exposure to absolute maximum rating conditions for extended periods may affect device reliability. Exceeding only one of these values may cause irreversible damage to the integrated circuit.*

¹ T_S is the soldering point temperature. T_S is measured on the emitter lead at the soldering point of the PCB.

Thermal characteristics

2 Thermal characteristics

Table 3 Thermal resistance

Parameter	Symbol	Values			Unit	Note or test condition
		Min.	Typ.	Max.		
Junction - soldering point	R_{thJS}	-	290	-	K/W	-

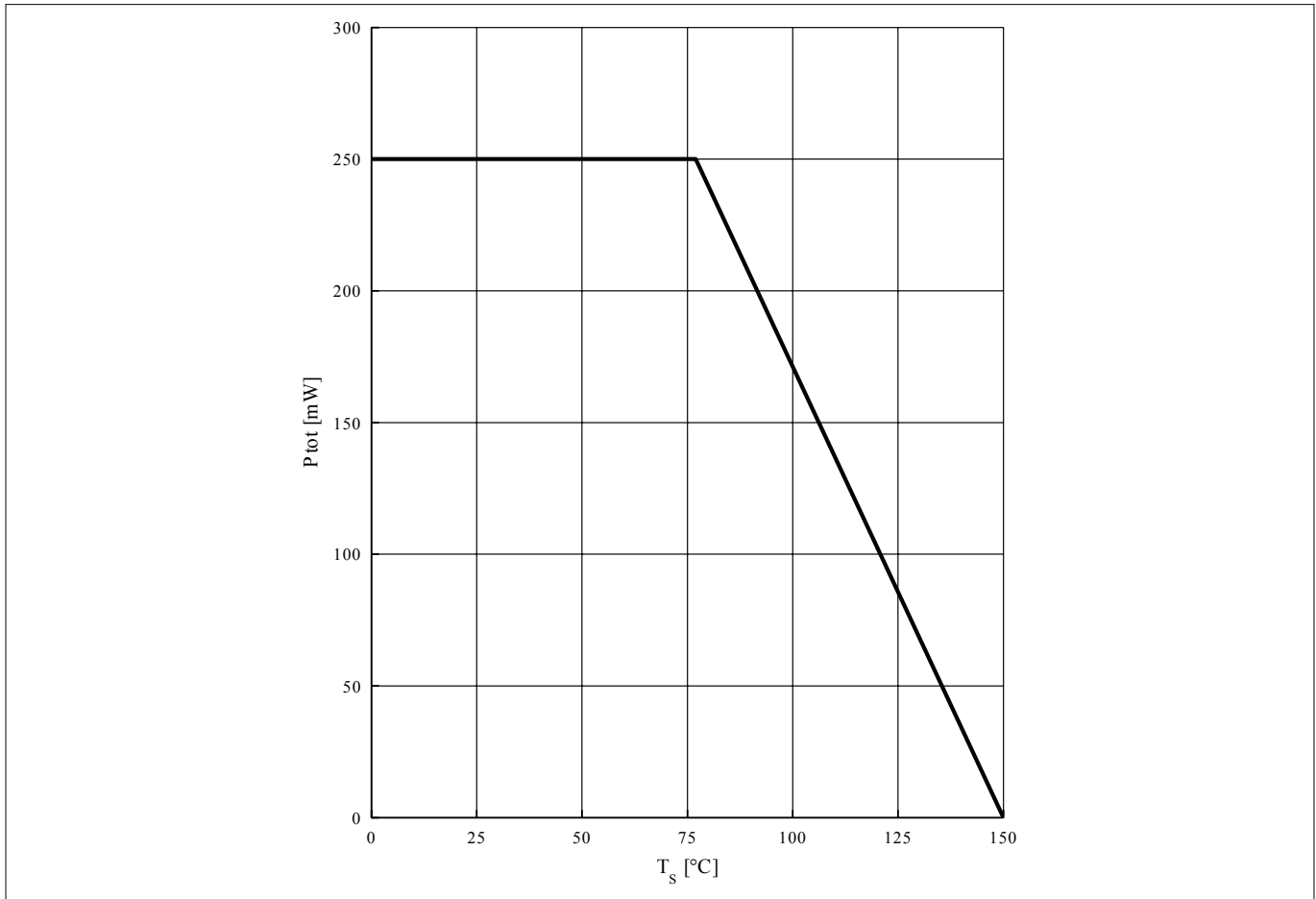

Figure 1 Total power dissipation $P_{tot} = f(T_s)$

Thermal characteristics

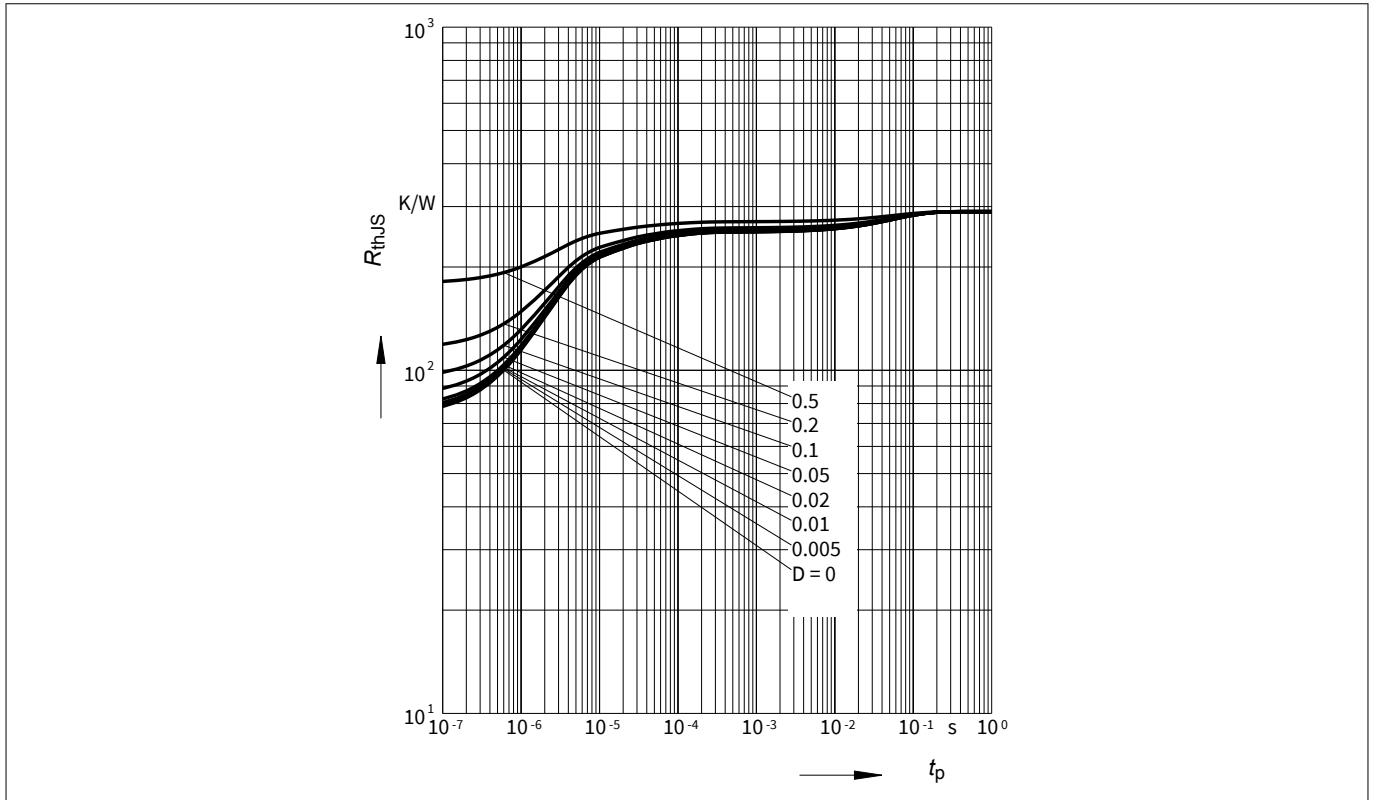

Figure 2 Permissible pulse load $R_{thJS} = f(t_p)$

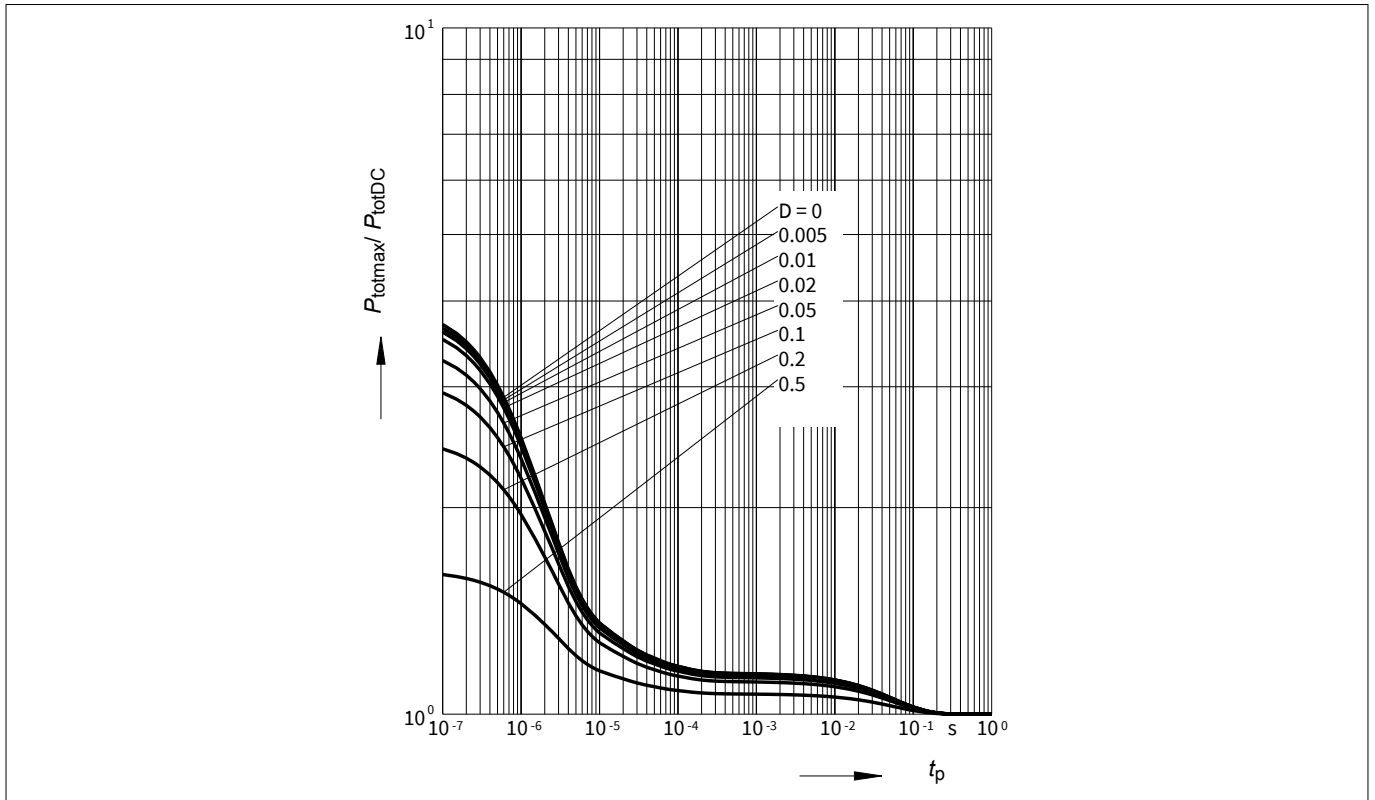

Figure 3 Permissible pulse load $P_{tot,max} / P_{tot,DC} = f(t_p)$

Electrical characteristics

3 Electrical characteristics

3.1 DC characteristics

Table 4 DC characteristics at $T_A = 25\text{ °C}$

Parameter	Symbol	Values			Unit	Note or test condition
		Min.	Typ.	Max.		
Collector emitter breakdown voltage	$V_{(BR)CEO}$	4.5	5	–	V	$I_C = 1\text{ mA}$, $I_B = 0$, open base
Collector emitter leakage current	I_{CES}	–	–	10 ²⁾	μA	$V_{CE} = 10\text{ V}$, $V_{BE} = 0$, E-B short circuited
Collector base leakage current	I_{CBO}			100 ²⁾	nA	$V_{CB} = 5\text{ V}$, $I_E = 0$, open emitter
Emitter base leakage current	I_{EBO}			10 ²⁾	μA	$V_{EB} = 0.5\text{ V}$, $I_C = 0$, open collector
DC current gain	h_{FE}	50	110	170		$V_{CE} = 3.5\text{ V}$, $I_C = 20\text{ mA}$, pulse measured

3.2 General AC characteristics

Table 5 General AC characteristics at $T_A = 25\text{ °C}$

Parameter	Symbol	Values			Unit	Note or test condition
		Min.	Typ.	Max.		
Transition frequency	f_T	21	30	–	GHz	$V_{CE} = 4\text{ V}$, $I_C = 50\text{ mA}$, $f = 1\text{ GHz}$
Collector base capacitance	C_{CB}	–	0.14	0.24	pF	$V_{CB} = 2\text{ V}$, $V_{BE} = 0$, $f = 1\text{ MHz}$, emitter grounded
Collector emitter capacitance	C_{CE}		0.41	–		$V_{CE} = 2\text{ V}$, $V_{BE} = 0$, $f = 1\text{ MHz}$, base grounded
Emitter base capacitance	C_{EB}		0.59			$V_{EB} = 0.5\text{ V}$, $V_{CB} = 0$, $f = 1\text{ MHz}$, collector grounded

² Maximum values not limited by the device but by the short cycle time of the 100% test.

Electrical characteristics

3.3 Frequency dependent AC characteristics

Measurement setup is a test fixture with Bias-T's in a 50 Ω system, $T_A = 25\text{ °C}$.

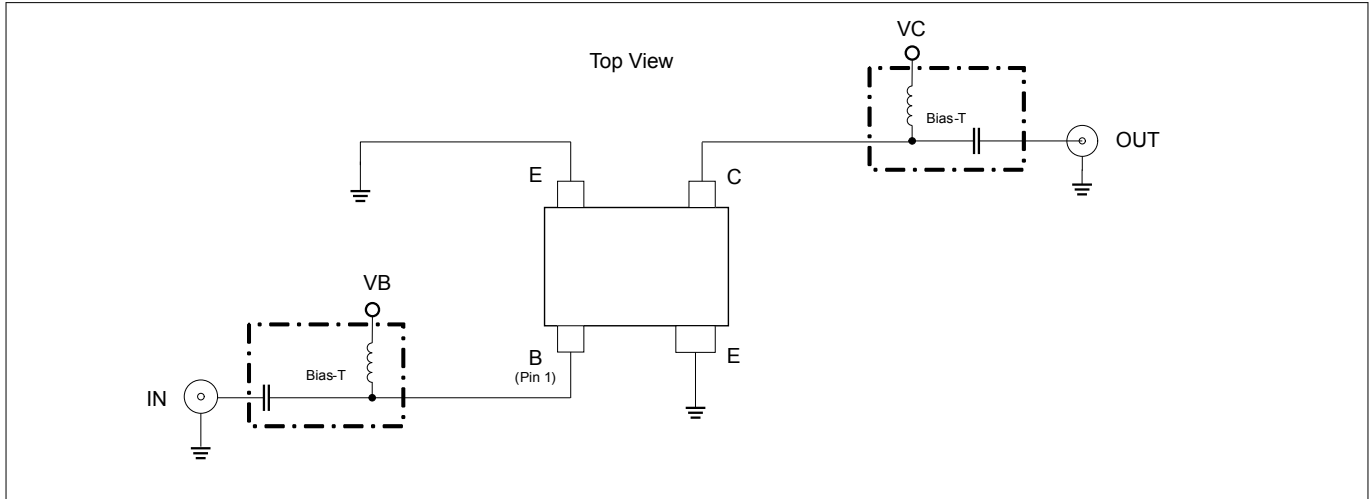

Figure 4 Testing circuit

Table 6 AC characteristics, $V_{CE} = 2\text{ V}$, $f = 1.8\text{ GHz}$

Parameter	Symbol	Values			Unit	Note or test condition
		Min.	Typ.	Max.		
Power gain					dB	$I_C = 20\text{ mA}$
<ul style="list-style-type: none"> Maximum stable power gain Transducer gain 	G_{ms} $ S_{21} ^2$	– 16	21.5 18.5	–		
Noise figure					dBm	$I_C = 5\text{ mA}$
<ul style="list-style-type: none"> Minimum noise figure 	NF_{min}	–	0.9	1.4		
Linearity					dBm	$I_C = 20\text{ mA}$, $Z_S = Z_L = 50\text{ }\Omega$
<ul style="list-style-type: none"> 3rd order intercept point at output 1 dB gain compression point at output 	OIP_3 OP_{1dB}		24.5 11	–		

Table 7 AC characteristics, $V_{CE} = 2\text{ V}$, $f = 3\text{ GHz}$

Parameter	Symbol	Values			Unit	Note or test condition
		Min.	Typ.	Max.		
Power gain					dB	$I_C = 20\text{ mA}$
<ul style="list-style-type: none"> Maximum available power gain Transducer gain 	G_{ma} $ S_{21} ^2$	–	16 14	–		
Noise figure					dBm	$I_C = 5\text{ mA}$
<ul style="list-style-type: none"> Minimum noise figure 	NF_{min}		1.3			

Note: $G_{ms} = |S_{21}/S_{12}|$ for $k < 1$; $G_{ma} = |S_{21}/S_{12}| \sqrt{k/(k^2-1)^{1/2}}$ for $k > 1$. In order to get the NF_{min} values stated in this chapter, the test fixture losses have been subtracted from all measured results. OIP_3 value depends on termination of all intermodulation frequency components. Termination used for this measurement is 50 Ω from 0.1 MHz to 6 GHz.

Electrical characteristics

3.4 Characteristic AC diagrams

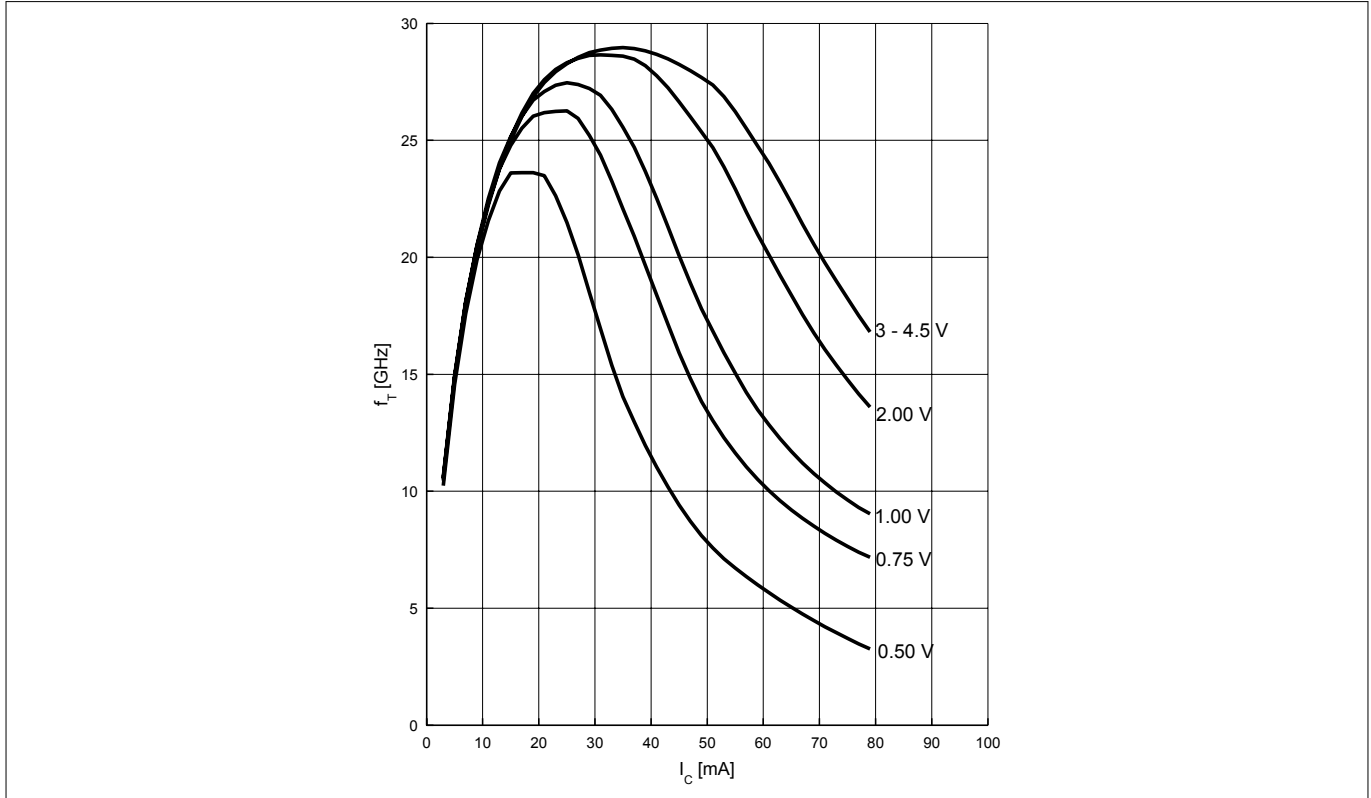

Figure 5 Transition frequency $f_T = f(I_C)$, $f = 2$ GHz, $V_{CE} = \text{parameter}$

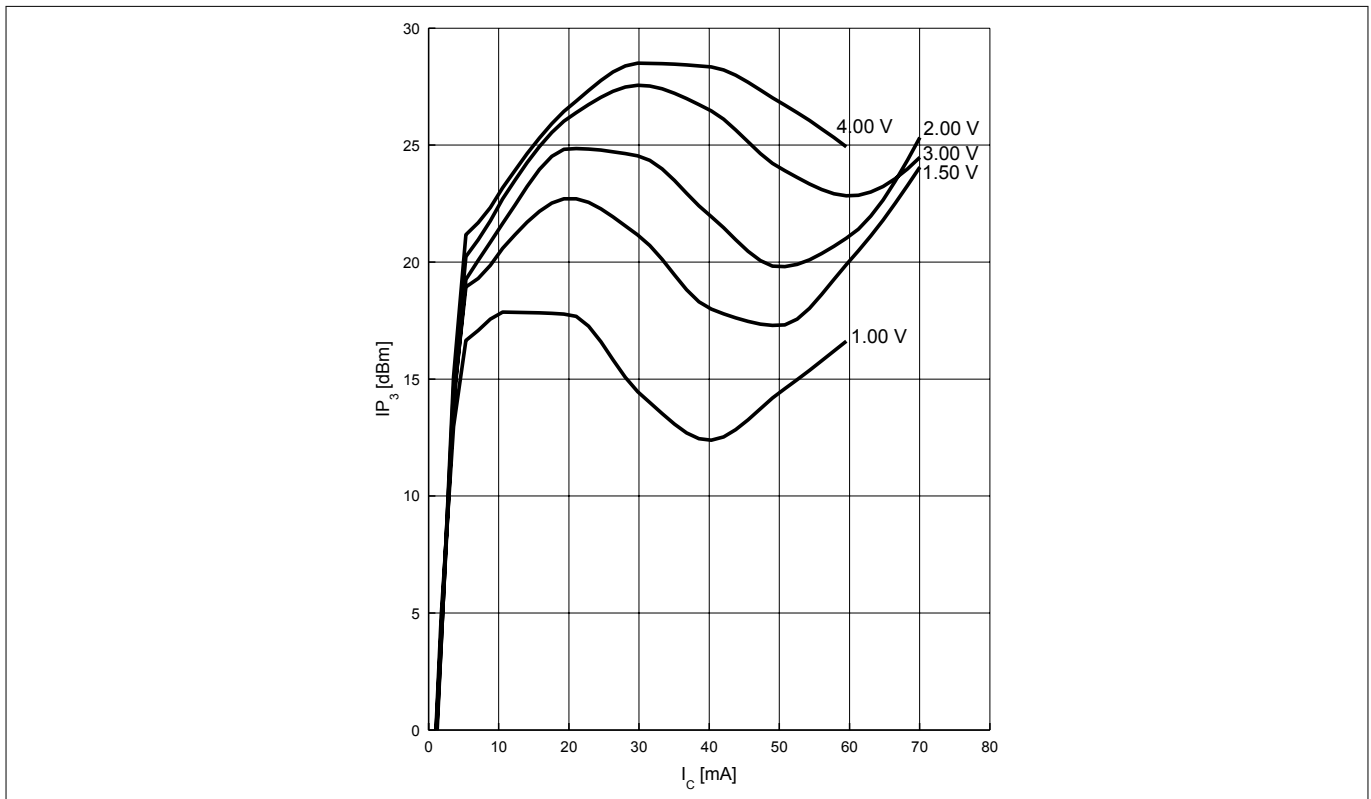

Figure 6 3rd order intercept point $OIP_3 = f(I_C)$, $Z_S = Z_L = 50 \Omega$, $f = 900$ MHz, $V_{CE} = \text{parameter}$

Electrical characteristics

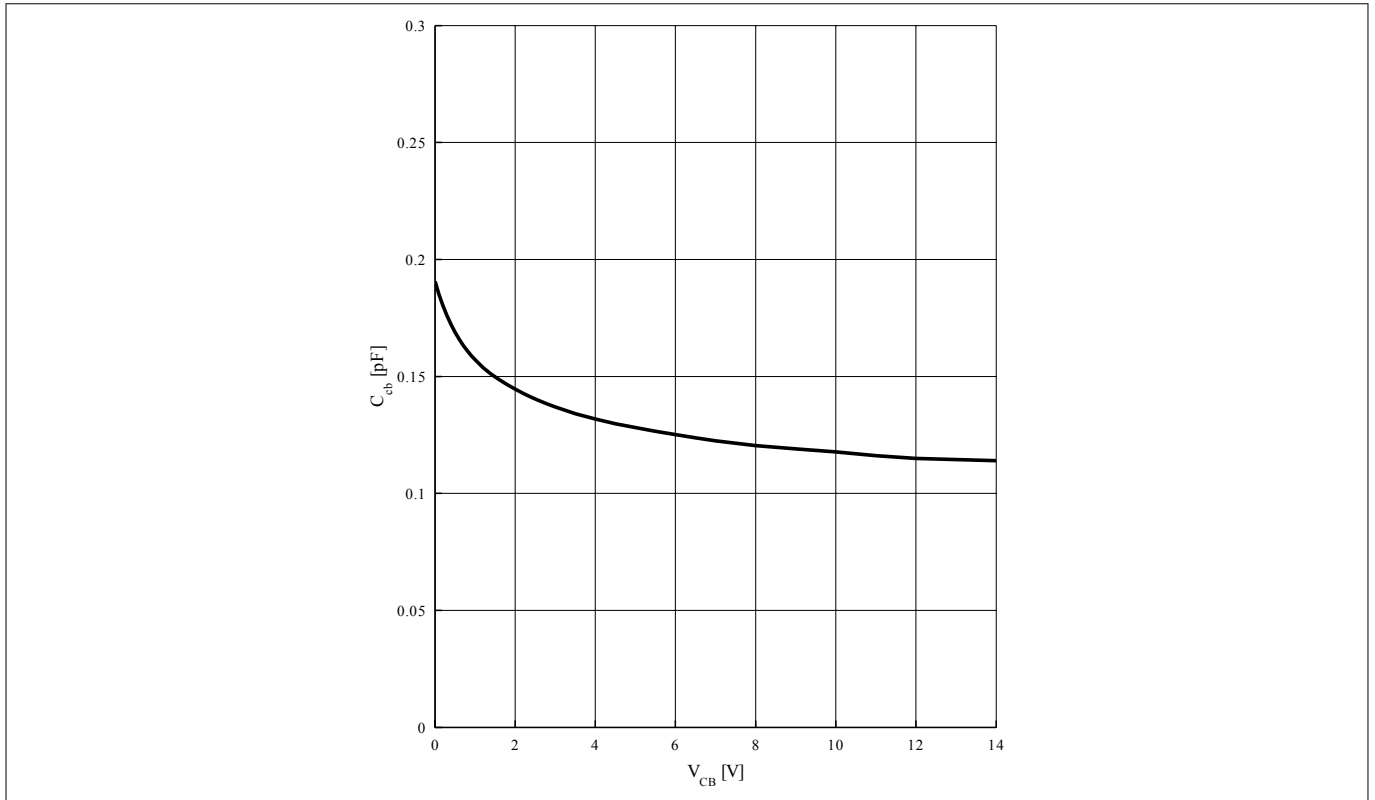

Figure 7 Collector base capacitance $C_{CB} = f(V_{CB})$, $f = 1$ MHz

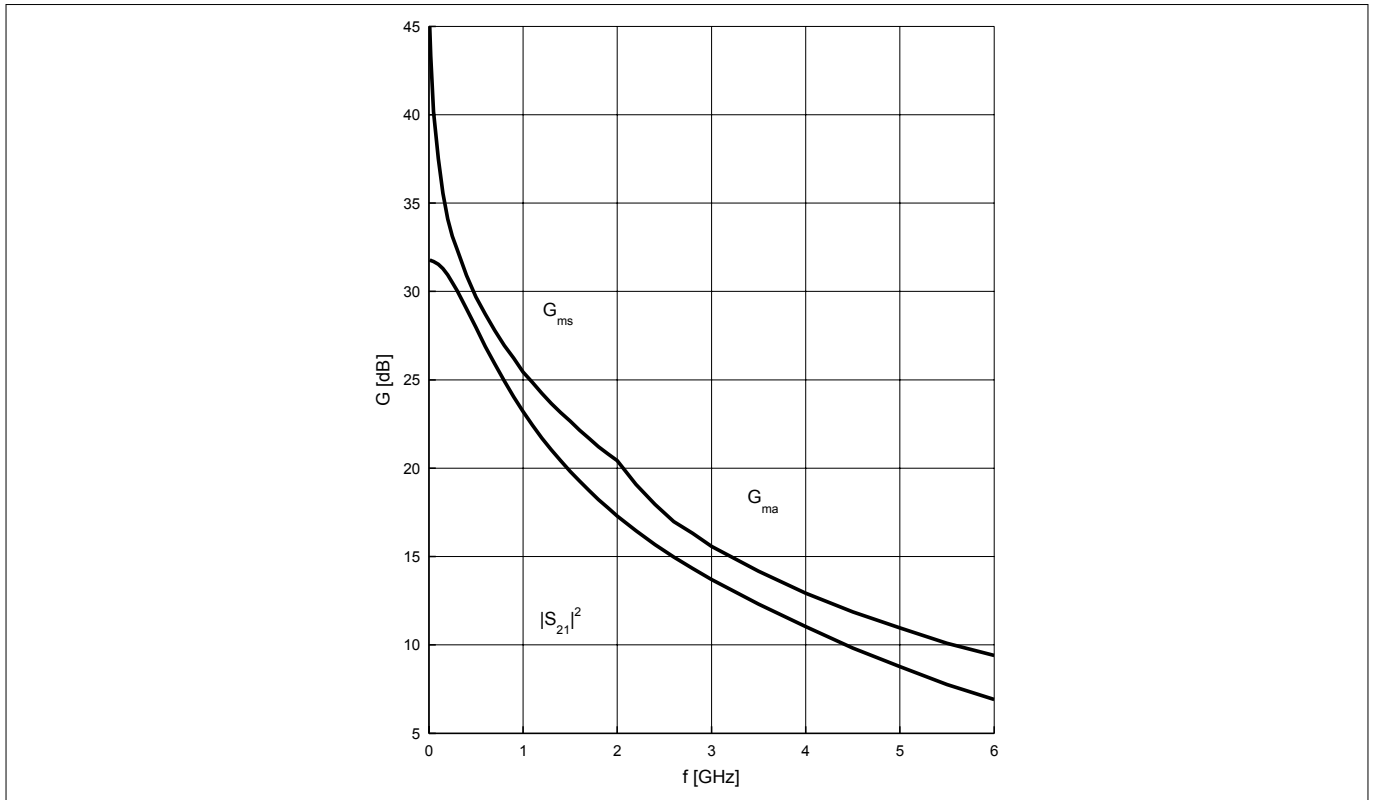

Figure 8 Gain G_{ma} , G_{ms} , $IS_{21}^2 = f(f)$, $V_{CE} = 3$ V, $I_C = 25$ mA

Electrical characteristics

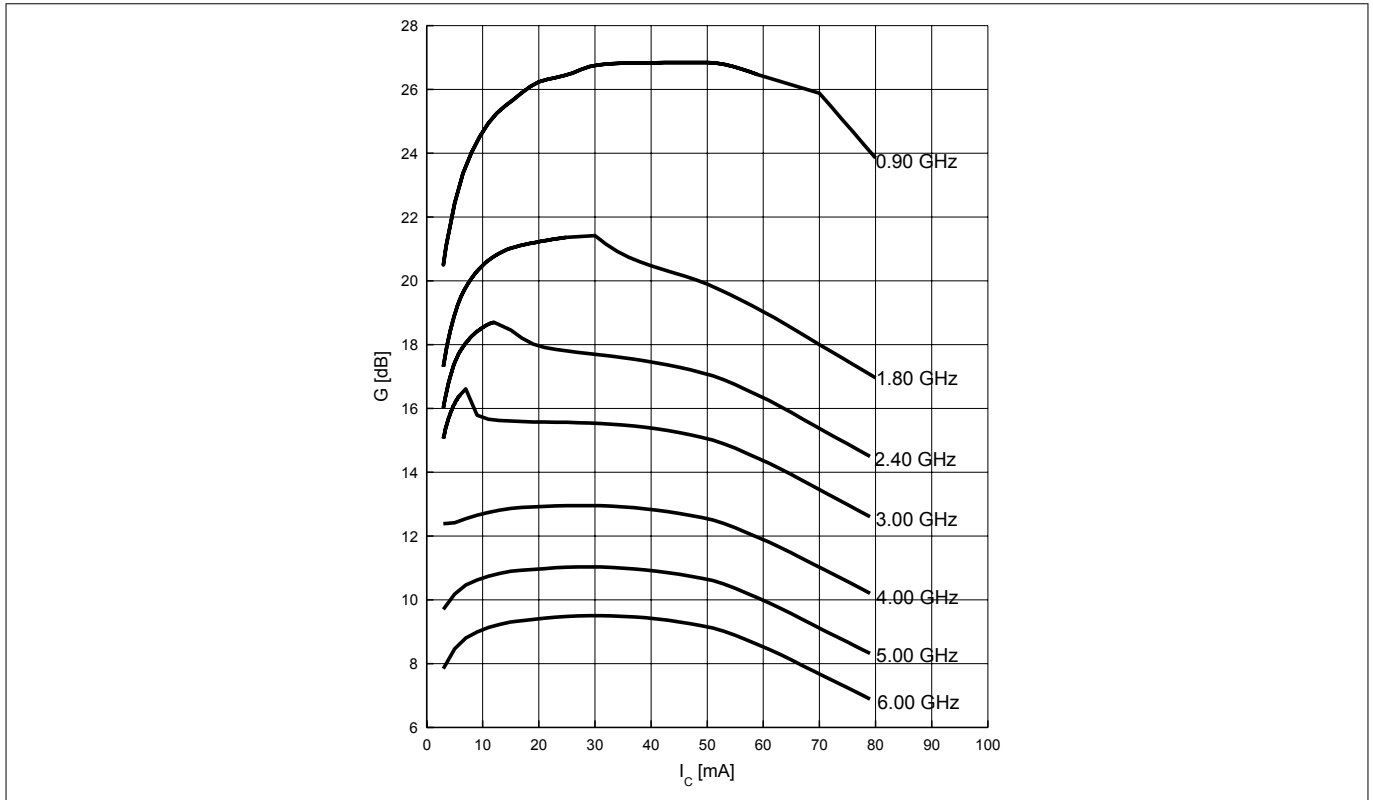

Figure 9 Maximum power gain $G_{max} = f(I_C)$, $V_{CE} = 3\text{ V}$, $f = \text{parameter in GHz}$

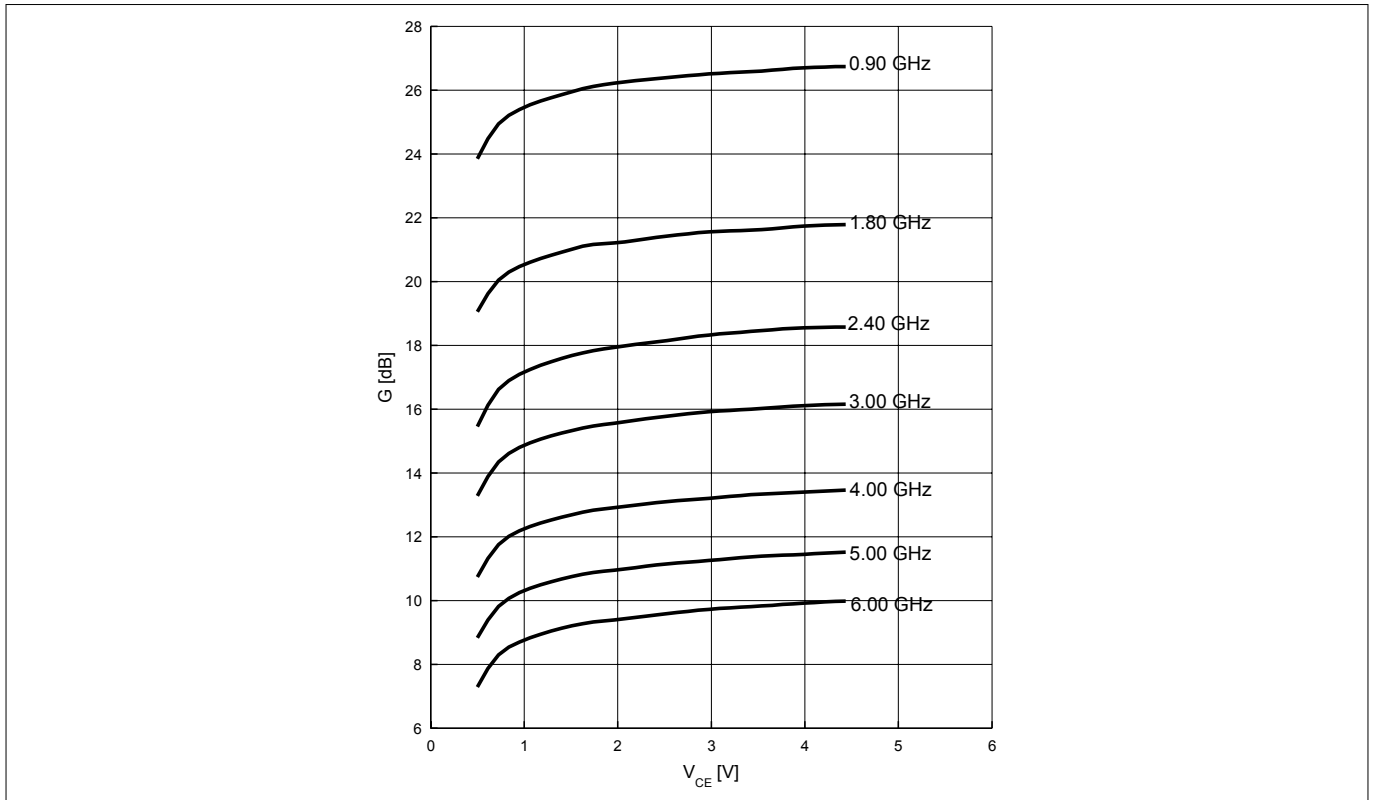

Figure 10 Maximum power gain $G_{max} = f(V_{CE})$, $I_C = 20\text{ mA}$, $f = \text{parameter in GHz}$

Electrical characteristics

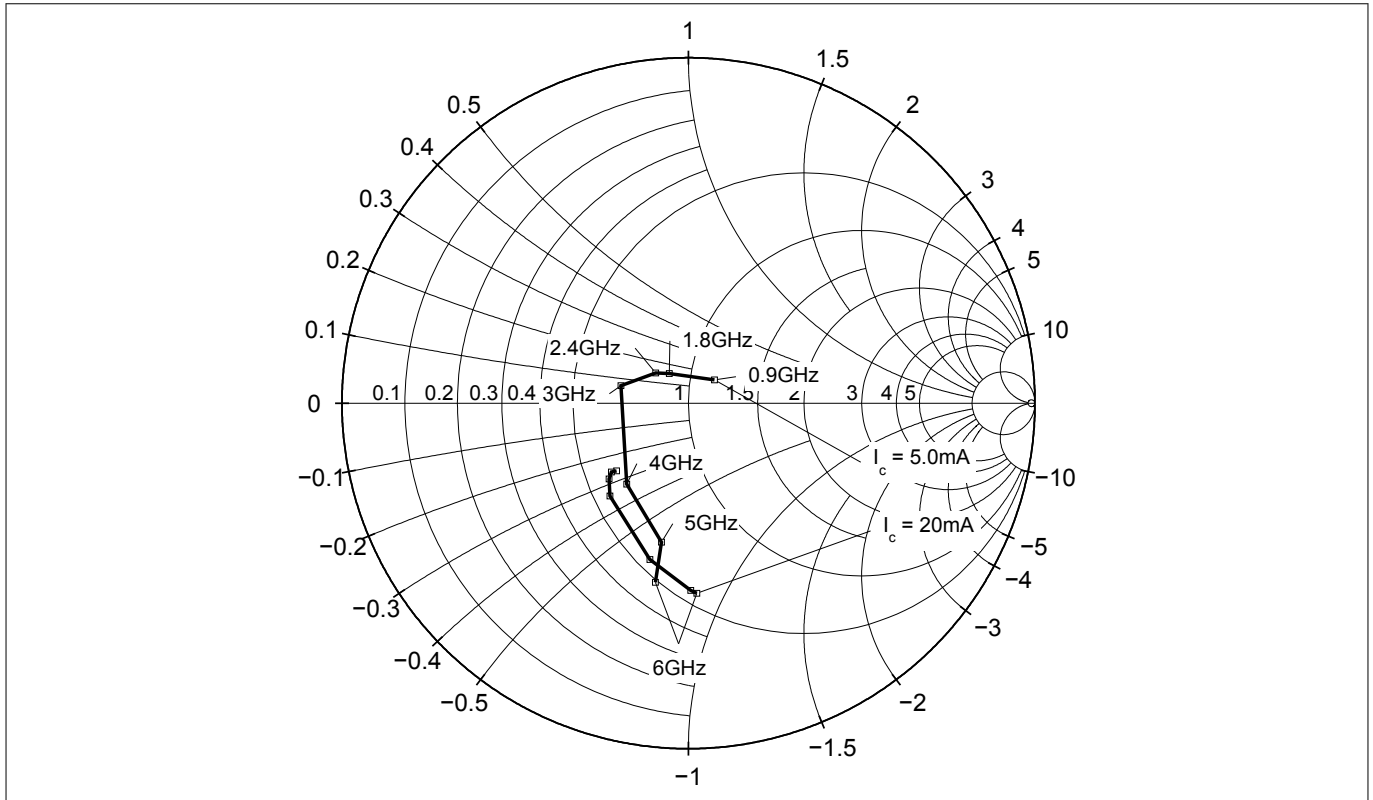

Figure 11 Source impedance for minimum noise figure $Z_{S,opt} = f(f)$, $V_{CE} = 3\text{ V}$, $I_C = 5 / 20\text{ mA}$

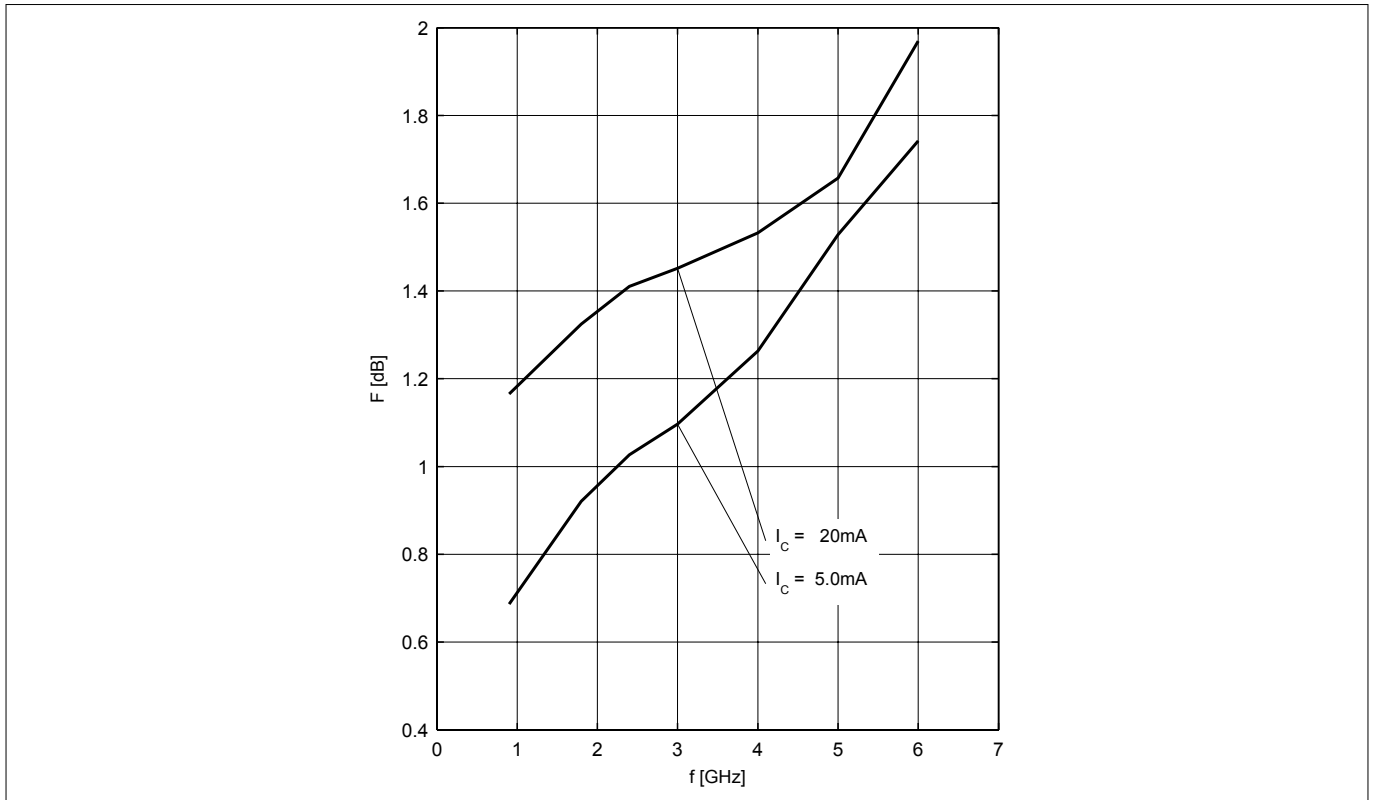

Figure 12 Noise figure $NF_{min} = f(f)$, $V_{CE} = 3\text{ V}$, $Z_S = Z_{S,opt}$, $I_C = 5 / 20\text{ mA}$

Electrical characteristics

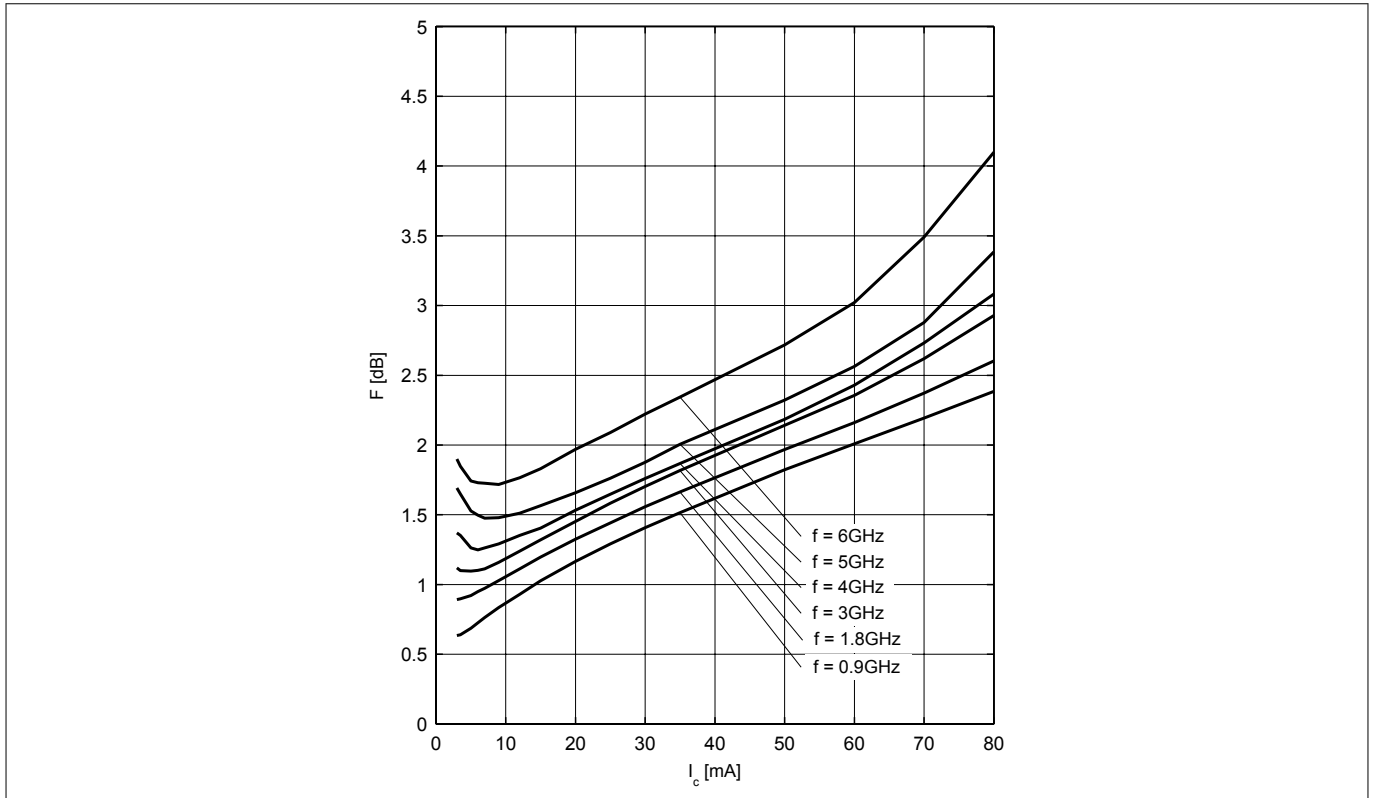

Figure 13 Noise figure $NF_{min} = f(I_C)$, $V_{CE} = 3\text{ V}$, $Z_S = Z_{S,opt}$, $f = \text{parameter in GHz}$

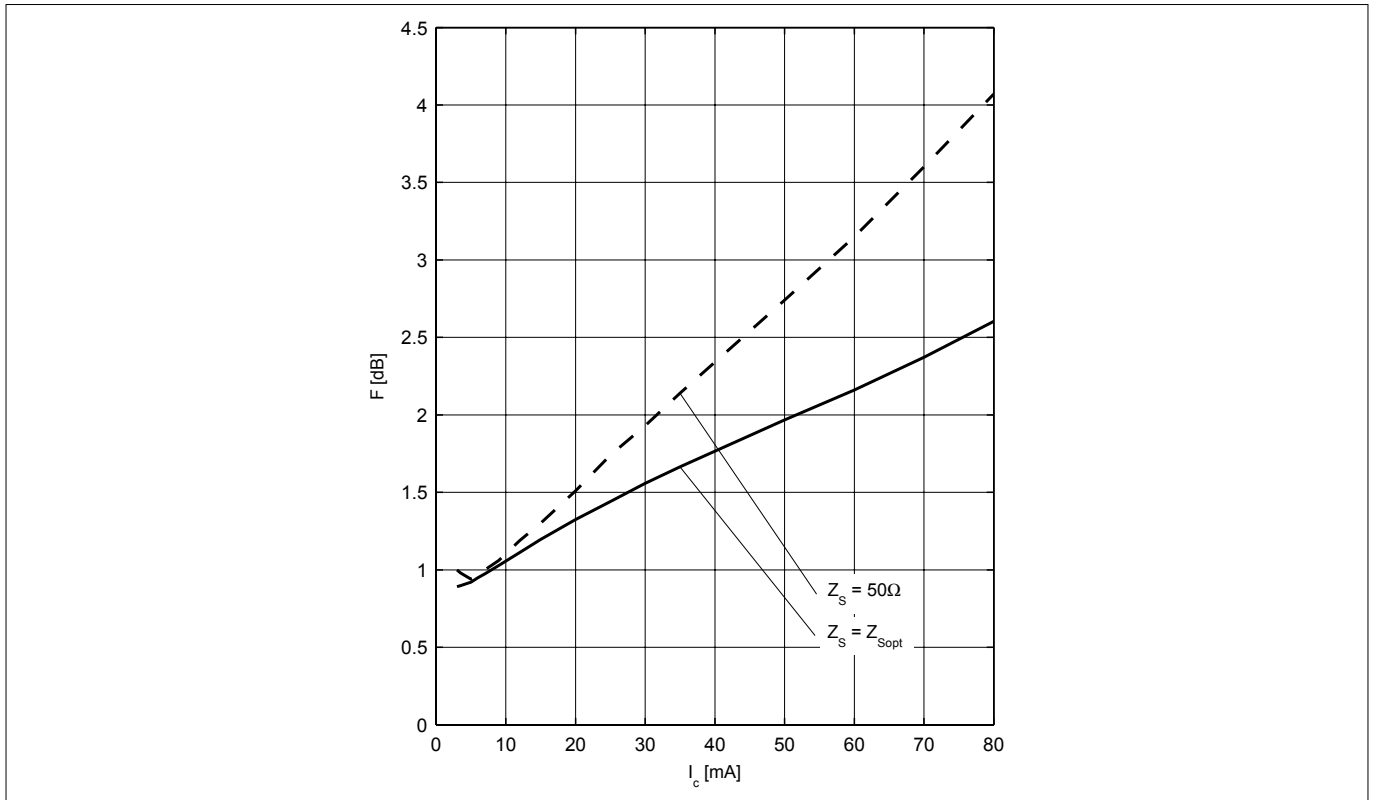

Figure 14 Noise figure $NF_{50} = f(I_C)$, $Z_S = 50\ \Omega$, $NF_{min} = f(I_C)$, $Z_S = Z_{S,opt}$, $V_{CE} = 3\text{ V}$, $f = 1.8\text{ GHz}$

Note: The curves shown in this chapter have been generated using typical devices but shall not be considered as a guarantee that all devices have identical characteristic curves. $T_A = 25\text{ }^\circ\text{C}$.

Package information SOT343

4 Package information SOT343

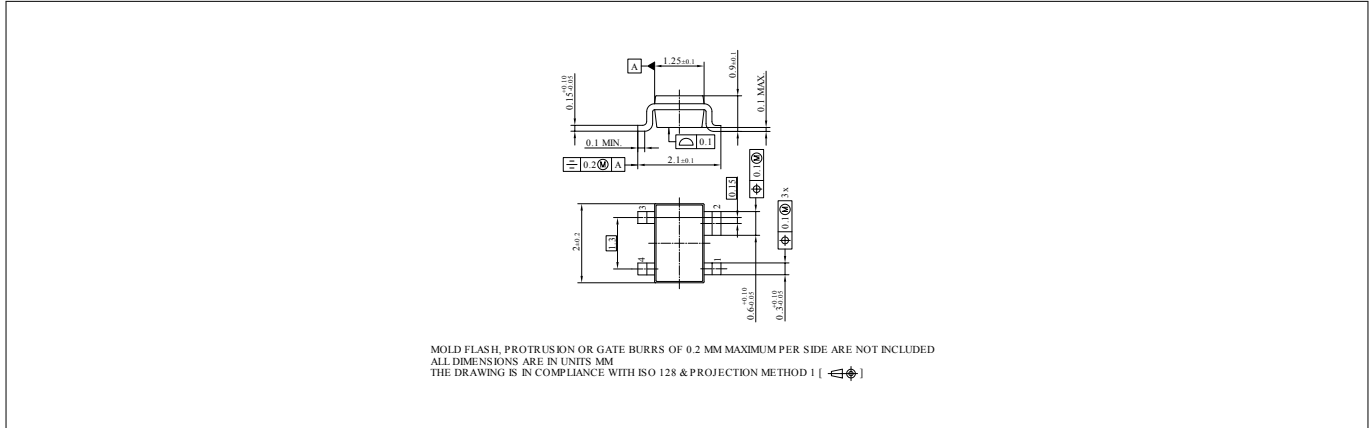

Figure 15 Package outline

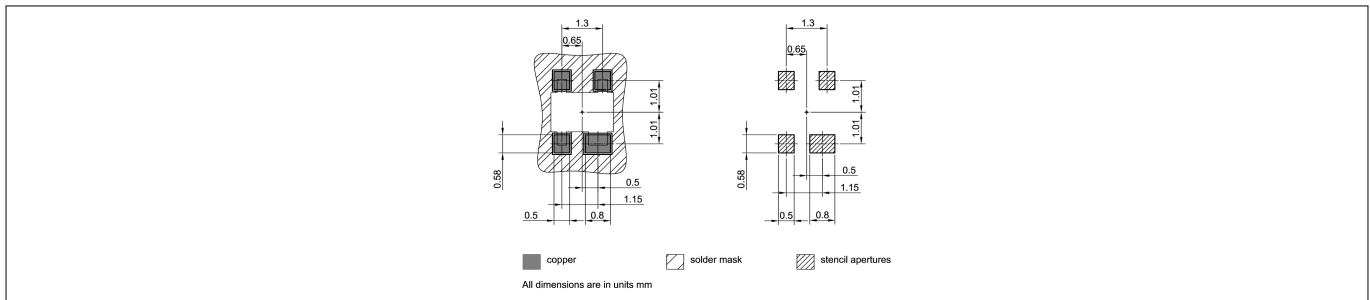

Figure 16 Foot print

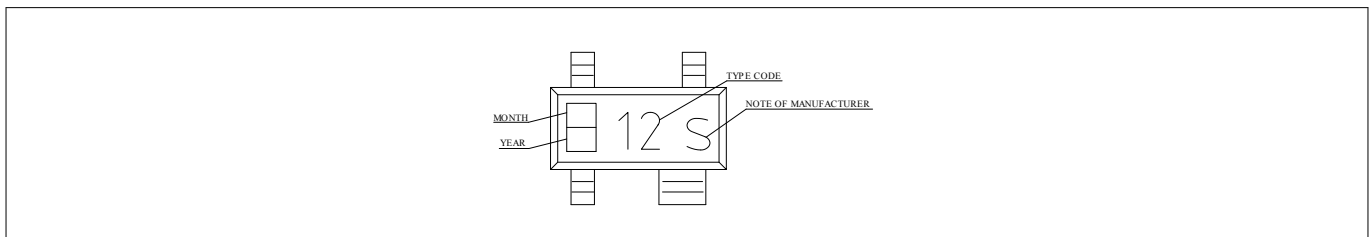

Figure 17 Marking layout example

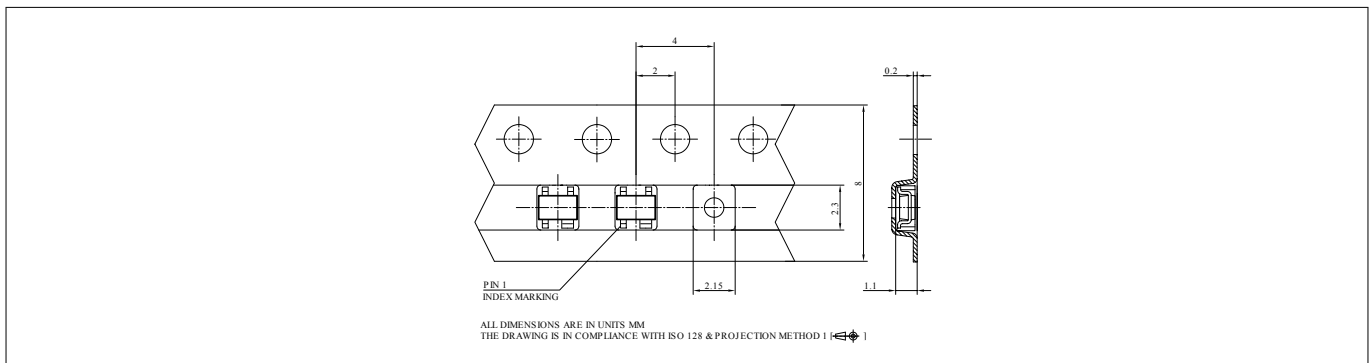

Figure 18 Tape dimensions

Revision history

Revision history

Document version	Date of release	Description of changes
Revision 2.0	2019-01-25	New datasheet layout.