

# BFP842ESD

## SiGe:C NPN RF bipolar transistor



### Product description

The BFP842ESD is a high performance RF heterojunction bipolar transistor (HBT) with an integrated ESD protection suitable for 2.3 - 3.5 GHz LNA applications.



### Feature list

- Unique combination of high end RF performance and robustness: 16 dBm maximum RF input power, 1 kV HBM ESD hardness
- High transition frequency  $f_T = 57$  GHz to enable best in class noise performance at high frequencies:  
 $NF_{min} = 0.65$  dB at 3.5 GHz, 2.5 V, 5 mA
- High gain  $G_{ma} = 17.5$  dB at 3.5 GHz, 2.5 V, 15 mA
- $OIP_3 = 25.5$  dBm at 3.5 GHz, 2.5 V, 15 mA
- Suitable for low voltage applications e.g.  $V_{CC} = 1.2$  V and 1.8 V (2.85 V, 3.3 V, 3.6 V require corresponding collector resistor)

### Product validation

Qualified for industrial applications according to the relevant tests of JEDEC47/20/22.

### Potential applications

- Wireless communications: WLAN, WiMAX and Bluetooth
- Satellite communication systems: GNSS navigation systems (GPS, GLONASS, BeiDou, Galileo), satellite radio (SDARs, DAB) and C-band LNB (1st and 2nd stage LNA)
- Multimedia applications such as mobile/portable TV, mobile TV and FM radio
- 3G/4G UMTS/LTE mobile phone applications
- ISM applications like RKE, AMR and Zigbee

### Device information

**Table 1** Part information

| Product name / Ordering code    | Package | Pin configuration |       |       |       | Marking | Pieces / Reel |
|---------------------------------|---------|-------------------|-------|-------|-------|---------|---------------|
| BFP842ESD / BFP842ESDH6327XTSA1 | SOT343  | 1 = B             | 2 = E | 3 = C | 4 = E | T9s     | 3000          |

**Attention:** ESD (Electrostatic discharge) sensitive device, observe handling precautions

## Table of contents

|          |  |    |
|----------|--|----|
|          | <b>Product description</b> .....             | 1  |
|          | <b>Feature list</b> .....                    | 1  |
|          | <b>Product validation</b> .....              | 1  |
|          | <b>Potential applications</b> .....          | 1  |
|          | <b>Device information</b> .....              | 1  |
|          | <b>Table of contents</b> .....               | 2  |
| <b>1</b> | <b>Absolute maximum ratings</b> .....        | 3  |
| <b>2</b> | <b>Thermal characteristics</b> .....         | 4  |
| <b>3</b> | <b>Electrical characteristics</b> .....      | 5  |
| 3.1      | DC characteristics .....                     | 5  |
| 3.2      | General AC characteristics .....             | 5  |
| 3.3      | Frequency dependent AC characteristics ..... | 6  |
| 3.4      | Characteristic DC diagrams .....             | 9  |
| 3.5      | Characteristic AC diagrams .....             | 12 |
| <b>4</b> | <b>Package information SOT343</b> .....      | 19 |
|          | <b>Revision history</b> .....                | 20 |
|          | <b>Disclaimer</b> .....                      | 21 |

**Absolute maximum ratings**

**1 Absolute maximum ratings**

**Table 2 Absolute maximum ratings at  $T_A = 25\text{ °C}$  (unless otherwise specified)**

| Parameter                               | Symbol     | Values |      | Unit | Note or test condition                         |
|---|------------|--------|------|------|--|
|   |            | Min.   | Max. |      |  |
| Collector emitter voltage               | $V_{CEO}$  | -      | 3.25 | V    | Open base                                      |
|   |            |        | 2.9  |      | $T_A = -40\text{ °C}$ , open base              |
| Collector emitter voltage <sup>1)</sup> | $V_{CES}$  |        | 3.25 |      | E-B short circuited                            |
|   |            |        | 2.9  |      | $T_A = -40\text{ °C}$ ,<br>E-B short circuited |
| Collector base voltage <sup>2)</sup>    | $V_{CBO}$  |        | 4.1  |      | Open emitter                                   |
|   |            |        | 3.5  |      | $T_A = -40\text{ °C}$ , open emitter           |
| Base current                            | $I_B$      | -5     | 3    | mA   |  |
| Collector current                       | $I_C$      | -      | 40   |      |  |
| RF input power                          | $P_{RFIn}$ |        | 16   | dBm  |  |
| ESD stress pulse                        | $V_{ESD}$  | -1     | 1    | kV   | HBM, all pins, acc. to JESD22-A114             |
| Total power dissipation <sup>3)</sup>   | $P_{tot}$  | -      | 120  | mW   | $T_S \leq 111\text{ °C}$                       |
| Junction temperature                    | $T_J$      |        | 150  |      |  |
| Storage temperature                     | $T_{Stg}$  | -55    |      |      |  |

**Attention:** *Stresses above the max. values listed here may cause permanent damage to the device. Exposure to absolute maximum rating conditions for extended periods may affect device reliability. Exceeding only one of these values may cause irreversible damage to the integrated circuit.*

<sup>1</sup>  $V_{CES}$  is similar to  $V_{CEO}$  due to design.

<sup>2</sup>  $V_{CBO}$  is similar to  $V_{CEO}$  due to design.

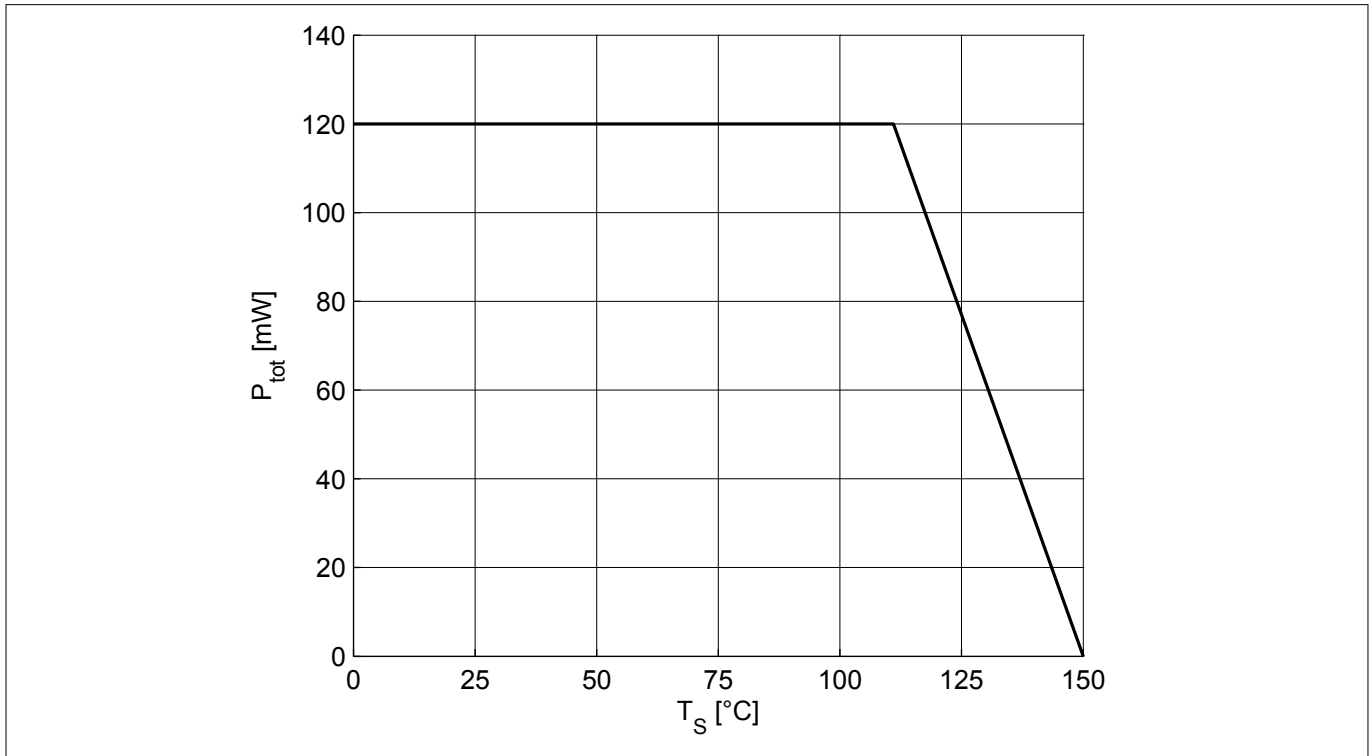
<sup>3</sup>  $T_S$  is the soldering point temperature.  $T_S$  is measured on the emitter lead at the soldering point of the PCB.

Thermal characteristics

## 2 Thermal characteristics

**Table 3 Thermal resistance**

| Parameter                  | Symbol     | Values |      |      | Unit | Note or test condition |
|----------------------------|------------|--------|------|------|------|------------------------|
|                            |            | Min.   | Typ. | Max. |      |                        |
| Junction - soldering point | $R_{thJS}$ | -      | 324  | -    | K/W  |                        |



**Figure 1 Total power dissipation  $P_{tot} = f(T_S)$**

**Electrical characteristics**

**3 Electrical characteristics**

**3.1 DC characteristics**

**Table 4 DC characteristics at  $T_A = 25\text{ °C}$**

| Parameter                           | Symbol        | Values |      |                   | Unit          | Note or test condition  |
|-------------------------------------|---------------|--------|------|-------------------|---------------|---|
|                                     |               | Min.   | Typ. | Max.              |               |   |
| Collector emitter breakdown voltage | $V_{(BR)CEO}$ | 3.25   | 3.7  | –                 | V             | $I_C = 1\text{ mA}$ , $I_B = 0$ , open base                     |
| Collector emitter leakage current   | $I_{CES}$     | –      | –    | 400 <sup>1)</sup> | nA            | $V_{CE} = 2\text{ V}$ , $V_{BE} = 0$ , E-B short circuited      |
| Collector base leakage current      | $I_{CBO}$     |        |      | 400 <sup>1)</sup> |               | $V_{CB} = 2\text{ V}$ , $I_E = 0$ , open emitter                |
| Emitter base leakage current        | $I_{EBO}$     |        |      | 10 <sup>1)</sup>  | $\mu\text{A}$ | $V_{EB} = 0.5\text{ V}$ , $I_C = 0$ , open collector            |
| DC current gain                     | $h_{FE}$      | 150    | 260  | 450               |               | $V_{CE} = 2.5\text{ V}$ , $I_C = 15\text{ mA}$ , pulse measured |

**3.2 General AC characteristics**

**Table 5 General AC characteristics at  $T_A = 25\text{ °C}$**

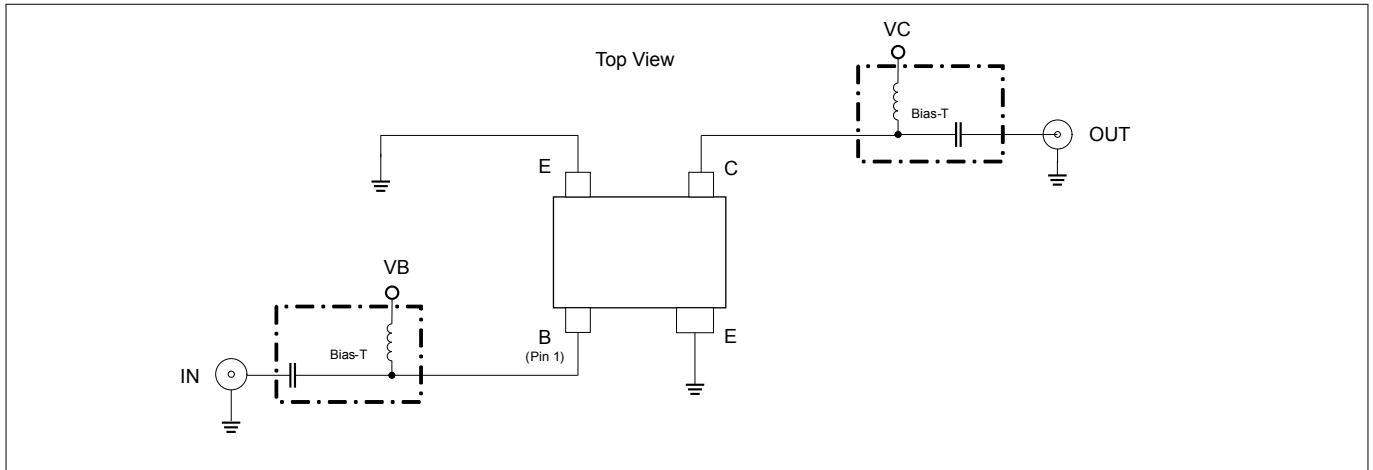
| Parameter                     | Symbol   | Values |      |      | Unit | Note or test condition   |
|-------------------------------|----------|--------|------|------|------|--|
|                               |          | Min.   | Typ. | Max. |      |  |
| Transition frequency          | $f_T$    | –      | 57   | –    | GHz  | $V_{CE} = 2.5\text{ V}$ , $I_C = 25\text{ mA}$ , $f = 1\text{ GHz}$              |
| Collector base capacitance    | $C_{CB}$ |        | 64   |      | fF   | $V_{CB} = 2\text{ V}$ , $V_{BE} = 0$ , $f = 1\text{ MHz}$ , emitter grounded     |
| Collector emitter capacitance | $C_{CE}$ |        | 0.46 |      | pF   | $V_{CE} = 2\text{ V}$ , $V_{BE} = 0$ , $f = 1\text{ MHz}$ , base grounded        |
| Emitter base capacitance      | $C_{EB}$ |        | 0.44 |      |      | $V_{EB} = 0.4\text{ V}$ , $V_{CB} = 0$ , $f = 1\text{ MHz}$ , collector grounded |

<sup>1</sup> Maximum values not limited by the device but by the short cycle time of the 100% test.

**Electrical characteristics**

**3.3 Frequency dependent AC characteristics**

Measurement setup is a test fixture with Bias-T's in a 50 Ω system,  $T_A = 25\text{ °C}$ .



**Figure 2 Testing circuit**

**Table 6 AC characteristics,  $V_{CE} = 2.5\text{ V}$ ,  $f = 450\text{ MHz}$**

| Parameter  | Symbol                   | Values |            |      | Unit | Note or test condition                                |
|--|--------------------------|--------|------------|------|------|---|
|  |                          | Min.   | Typ.       | Max. |      |   |
| Power gain   |                          | -      |            | -    | dB   | $I_C = 15\text{ mA}$                                  |
| <ul style="list-style-type: none"> <li>Maximum power gain</li> <li>Transducer gain</li> </ul>  | $G_{ms}$<br>$ S_{21} ^2$ |        | 33<br>29.5 |      |      |   |
| Noise figure   |                          |        |            |      |      | $I_C = 5\text{ mA}$                                   |
| <ul style="list-style-type: none"> <li>Minimum noise figure</li> <li>Associated gain</li> </ul>                                      | $NF_{min}$<br>$G_{ass}$  |        | 0.4<br>26  |      |      |   |
| Linearity  |                          |        |            |      | dBm  | $Z_S = Z_L = 50\text{ }\Omega$ , $I_C = 15\text{ mA}$ |
| <ul style="list-style-type: none"> <li>3rd order intercept point at output</li> <li>1 dB gain compression point at output</li> </ul> | $OIP_3$<br>$OP_{1dB}$    |        | 22<br>6.5  |      |      |   |

**Table 7 AC characteristics,  $V_{CE} = 2.5\text{ V}$ ,  $f = 900\text{ MHz}$**

| Parameter  | Symbol                   | Values |            |      | Unit | Note or test condition                                |
|--|--------------------------|--------|------------|------|------|---|
|  |                          | Min.   | Typ.       | Max. |      |   |
| Power gain   |                          | -      |            | -    | dB   | $I_C = 15\text{ mA}$                                  |
| <ul style="list-style-type: none"> <li>Maximum power gain</li> <li>Transducer gain</li> </ul>  | $G_{ms}$<br>$ S_{21} ^2$ |        | 29<br>26   |      |      |   |
| Noise figure   |                          |        |            |      |      | $I_C = 5\text{ mA}$                                   |
| <ul style="list-style-type: none"> <li>Minimum noise figure</li> <li>Associated gain</li> </ul>                                      | $NF_{min}$<br>$G_{ass}$  |        | 0.45<br>24 |      |      |   |
| Linearity  |                          |        |            |      | dBm  | $Z_S = Z_L = 50\text{ }\Omega$ , $I_C = 15\text{ mA}$ |
| <ul style="list-style-type: none"> <li>3rd order intercept point at output</li> <li>1 dB gain compression point at output</li> </ul> | $OIP_3$<br>$OP_{1dB}$    |        | 22.5<br>7  |      |      |   |

**Electrical characteristics**

**Table 8 AC characteristics,  $V_{CE} = 2.5\text{ V}$ ,  $f = 1.5\text{ GHz}$**

| Parameter  | Symbol                   | Values |                 |      | Unit | Note or test condition                          |
|--|--------------------------|--------|-----------------|------|------|---|
|  |                          | Min.   | Typ.            | Max. |      |   |
| Power gain   |                          | -      |                 | -    | dB   | $I_C = 15\text{ mA}$                            |
| <ul style="list-style-type: none"> <li>Maximum power gain</li> <li>Transducer gain</li> </ul>  | $G_{ms}$<br>$ S_{21} ^2$ |        | <br>25.5<br>23  |      |      |   |
| Noise figure   |                          |        |                 |      |      | $I_C = 5\text{ mA}$                             |
| <ul style="list-style-type: none"> <li>Minimum noise figure</li> <li>Associated gain</li> </ul>                                      | $NF_{min}$<br>$G_{ass}$  |        | <br>0.45<br>21  |      |      |   |
| Linearity  |                          |        |                 |      | dBm  | $Z_S = Z_L = 50\ \Omega$ , $I_C = 15\text{ mA}$ |
| <ul style="list-style-type: none"> <li>3rd order intercept point at output</li> <li>1 dB gain compression point at output</li> </ul> | $OIP_3$<br>$OP_{1dB}$    |        | <br>23.5<br>7.5 |      |      |   |

**Table 9 AC characteristics,  $V_{CE} = 2.5\text{ V}$ ,  $f = 1.9\text{ GHz}$**

| Parameter  | Symbol                   | Values |                 |      | Unit | Note or test condition                          |
|--|--------------------------|--------|-----------------|------|------|---|
|  |                          | Min.   | Typ.            | Max. |      |   |
| Power gain   |                          | -      |                 | -    | dB   | $I_C = 15\text{ mA}$                            |
| <ul style="list-style-type: none"> <li>Maximum power gain</li> <li>Transducer gain</li> </ul>  | $G_{ms}$<br>$ S_{21} ^2$ |        | <br>23.5<br>21  |      |      |   |
| Noise figure   |                          |        |                 |      |      | $I_C = 5\text{ mA}$                             |
| <ul style="list-style-type: none"> <li>Minimum noise figure</li> <li>Associated gain</li> </ul>                                      | $NF_{min}$<br>$G_{ass}$  |        | <br>0.5<br>19.5 |      |      |   |
| Linearity  |                          |        |                 |      | dBm  | $Z_S = Z_L = 50\ \Omega$ , $I_C = 15\text{ mA}$ |
| <ul style="list-style-type: none"> <li>3rd order intercept point at output</li> <li>1 dB gain compression point at output</li> </ul> | $OIP_3$<br>$OP_{1dB}$    |        | <br>24.5<br>8   |      |      |   |

**Table 10 AC characteristics,  $V_{CE} = 2.5\text{ V}$ ,  $f = 2.4\text{ GHz}$**

| Parameter  | Symbol                   | Values |               |      | Unit | Note or test condition                          |
|--|--------------------------|--------|---------------|------|------|---|
|  |                          | Min.   | Typ.          | Max. |      |   |
| Power gain   |                          | -      |               | -    | dB   | $I_C = 15\text{ mA}$                            |
| <ul style="list-style-type: none"> <li>Maximum power gain</li> <li>Transducer gain</li> </ul>  | $G_{ms}$<br>$ S_{21} ^2$ |        | <br>22<br>19  |      |      |   |
| Noise figure   |                          |        |               |      |      | $I_C = 5\text{ mA}$                             |
| <ul style="list-style-type: none"> <li>Minimum noise figure</li> <li>Associated gain</li> </ul>                                      | $NF_{min}$<br>$G_{ass}$  |        | <br>0.5<br>18 |      |      |   |
| Linearity  |                          |        |               |      | dBm  | $Z_S = Z_L = 50\ \Omega$ , $I_C = 15\text{ mA}$ |
| <ul style="list-style-type: none"> <li>3rd order intercept point at output</li> <li>1 dB gain compression point at output</li> </ul> | $OIP_3$<br>$OP_{1dB}$    |        | <br>25<br>8   |      |      |   |

**Electrical characteristics**

**Table 11 AC characteristics,  $V_{CE} = 2.5\text{ V}$ ,  $f = 3.5\text{ GHz}$**

| Parameter  | Symbol                   | Values |                 |      | Unit | Note or test condition                          |
|--|--------------------------|--------|-----------------|------|------|---|
|  |                          | Min.   | Typ.            | Max. |      |   |
| Power gain   |                          | -      |                 | -    | dB   | $I_C = 15\text{ mA}$                            |
| <ul style="list-style-type: none"> <li>Maximum power gain</li> <li>Transducer gain</li> </ul>  | $G_{ma}$<br>$ S_{21} ^2$ |        | <br>17.5<br>16  |      |      |   |
| Noise figure   |                          |        |                 |      |      | $I_C = 5\text{ mA}$                             |
| <ul style="list-style-type: none"> <li>Minimum noise figure</li> <li>Associated gain</li> </ul>                                      | $NF_{min}$<br>$G_{ass}$  |        | <br>0.65<br>15  |      |      |   |
| Linearity  |                          |        |                 |      | dBm  | $Z_S = Z_L = 50\ \Omega$ , $I_C = 15\text{ mA}$ |
| <ul style="list-style-type: none"> <li>3rd order intercept point at output</li> <li>1 dB gain compression point at output</li> </ul> | $OIP_3$<br>$OP_{1dB}$    |        | <br>25.5<br>8.5 |      |      |   |

**Table 12 AC characteristics,  $V_{CE} = 2.5\text{ V}$ ,  $f = 5.5\text{ GHz}$**

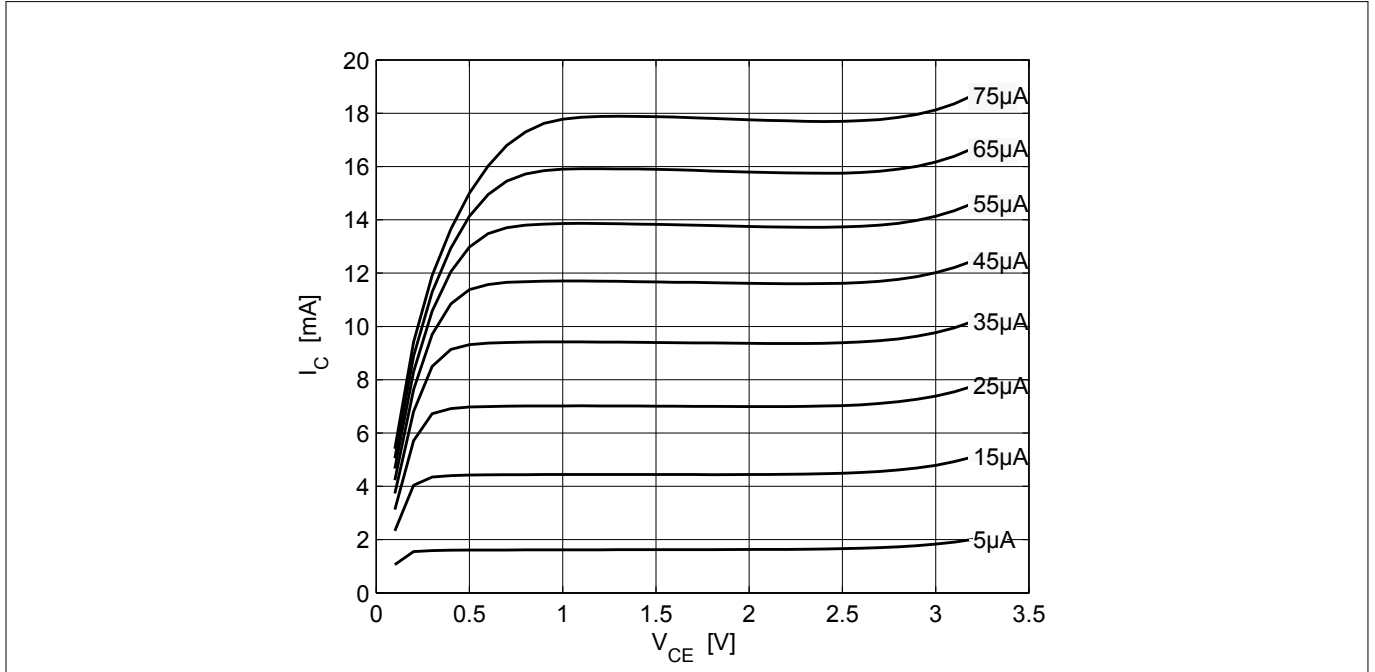
| Parameter  | Symbol                   | Values |                  |      | Unit | Note or test condition                          |
|--|--------------------------|--------|------------------|------|------|---|
|  |                          | Min.   | Typ.             | Max. |      |   |
| Power gain   |                          | -      |                  | -    | dB   | $I_C = 15\text{ mA}$                            |
| <ul style="list-style-type: none"> <li>Maximum power gain</li> <li>Transducer gain</li> </ul>  | $G_{ma}$<br>$ S_{21} ^2$ |        | <br>12.5<br>11.5 |      |      |   |
| Noise figure   |                          |        |                  |      |      | $I_C = 5\text{ mA}$                             |
| <ul style="list-style-type: none"> <li>Minimum noise figure</li> <li>Associated gain</li> </ul>                                      | $NF_{min}$<br>$G_{ass}$  |        | <br>0.85<br>10.5 |      |      |   |
| Linearity  |                          |        |                  |      | dBm  | $Z_S = Z_L = 50\ \Omega$ , $I_C = 15\text{ mA}$ |
| <ul style="list-style-type: none"> <li>3rd order intercept point at output</li> <li>1 dB gain compression point at output</li> </ul> | $OIP_3$<br>$OP_{1dB}$    |        | <br>24<br>8      |      |      |   |

Note:  $G_{ms} = |S_{21} / S_{12}|$  for  $k < 1$ ;  $G_{ma} = |S_{21} / S_{12}|(k - (k^2 - 1)^{1/2})$  for  $k > 1$ . In order to get the  $NF_{min}$  values stated in this chapter, the test fixture losses have been subtracted from all measured results.  $OIP_3$  value depends on termination of all intermodulation frequency components. Termination used for this measurement is  $50\ \Omega$  from 0.2 MHz to 12 GHz.

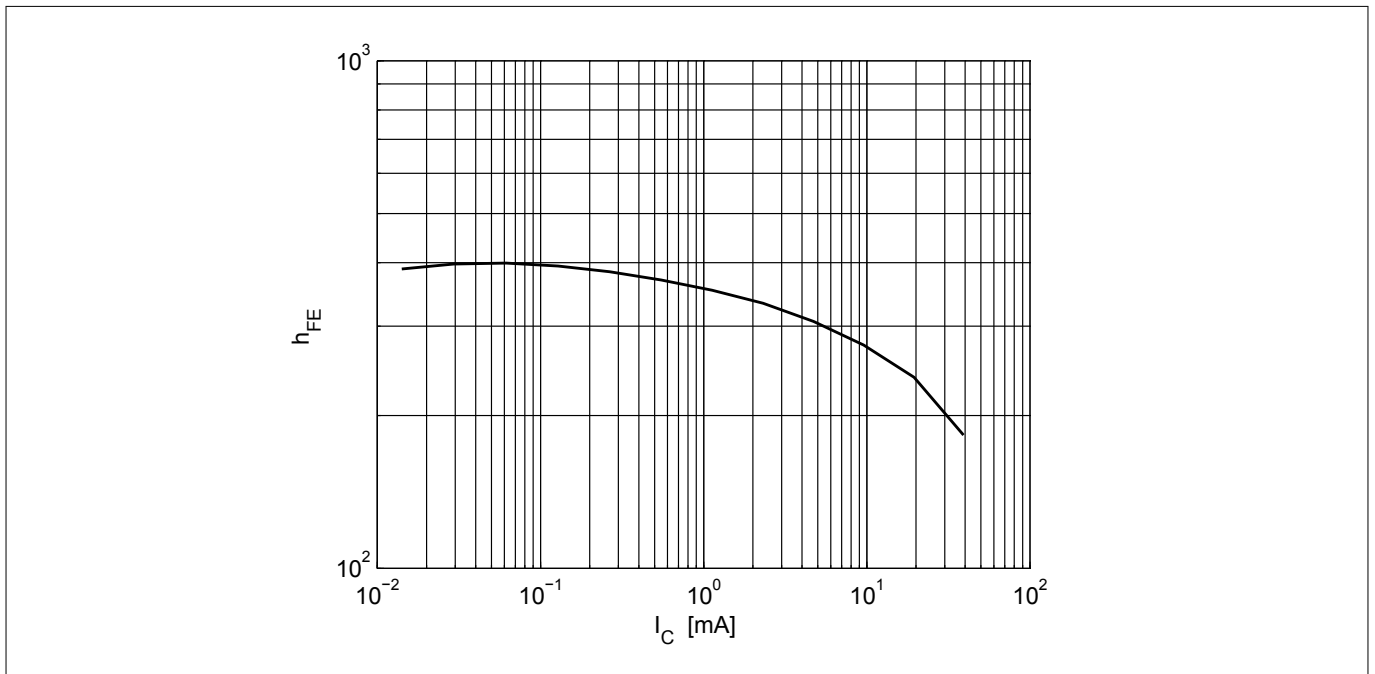


**Electrical characteristics**

**3.4 Characteristic DC diagrams**

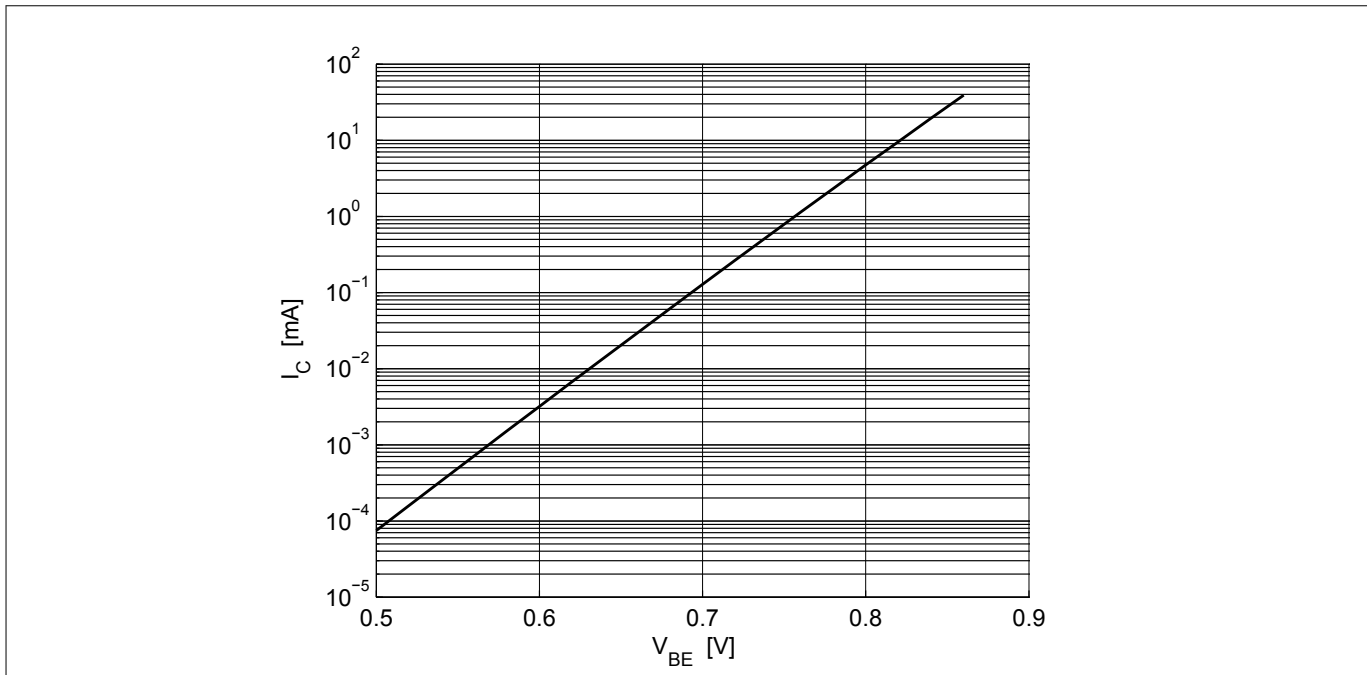


**Figure 3** Collector current vs. collector emitter voltage  $I_C = f(V_{CE})$ ,  $I_B = \text{parameter}$

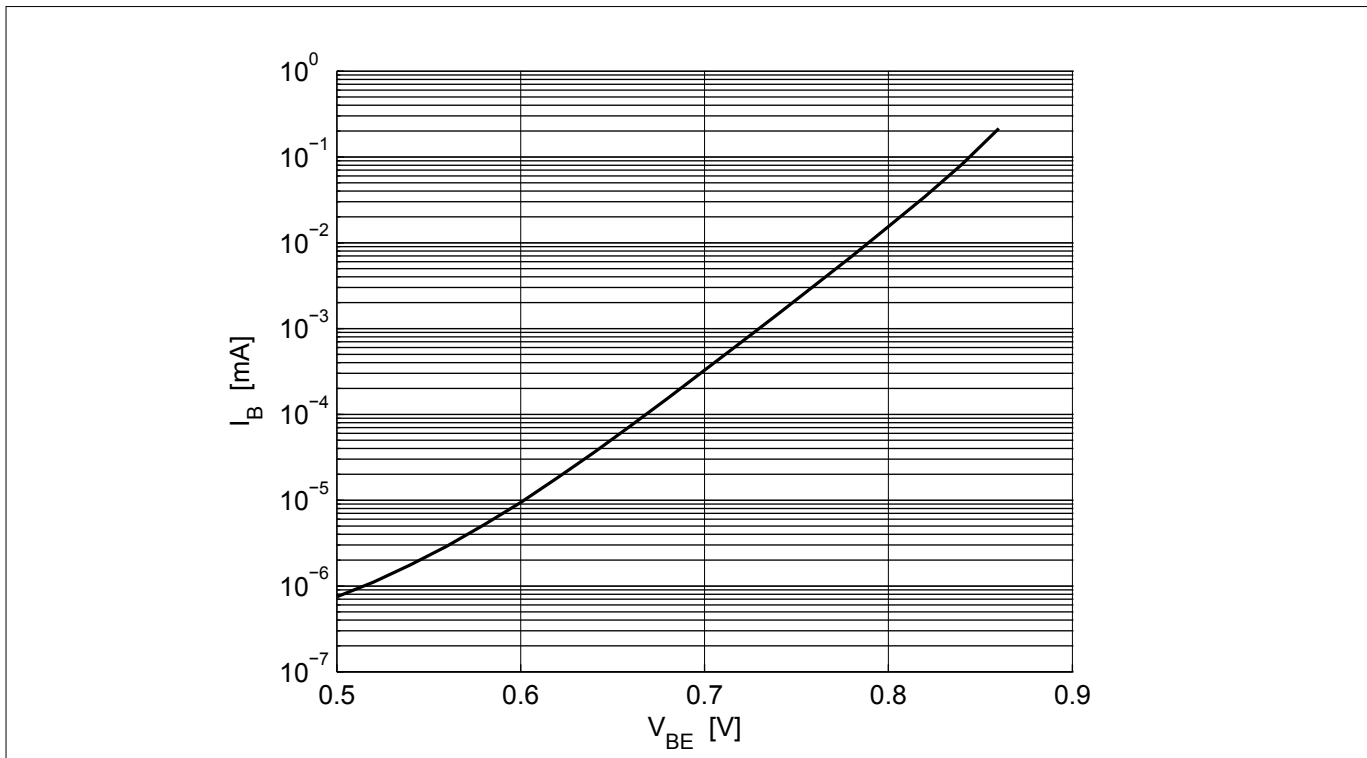


**Figure 4** DC current gain  $h_{FE} = f(I_C)$ ,  $V_{CE} = 2.5 V$

**Electrical characteristics**

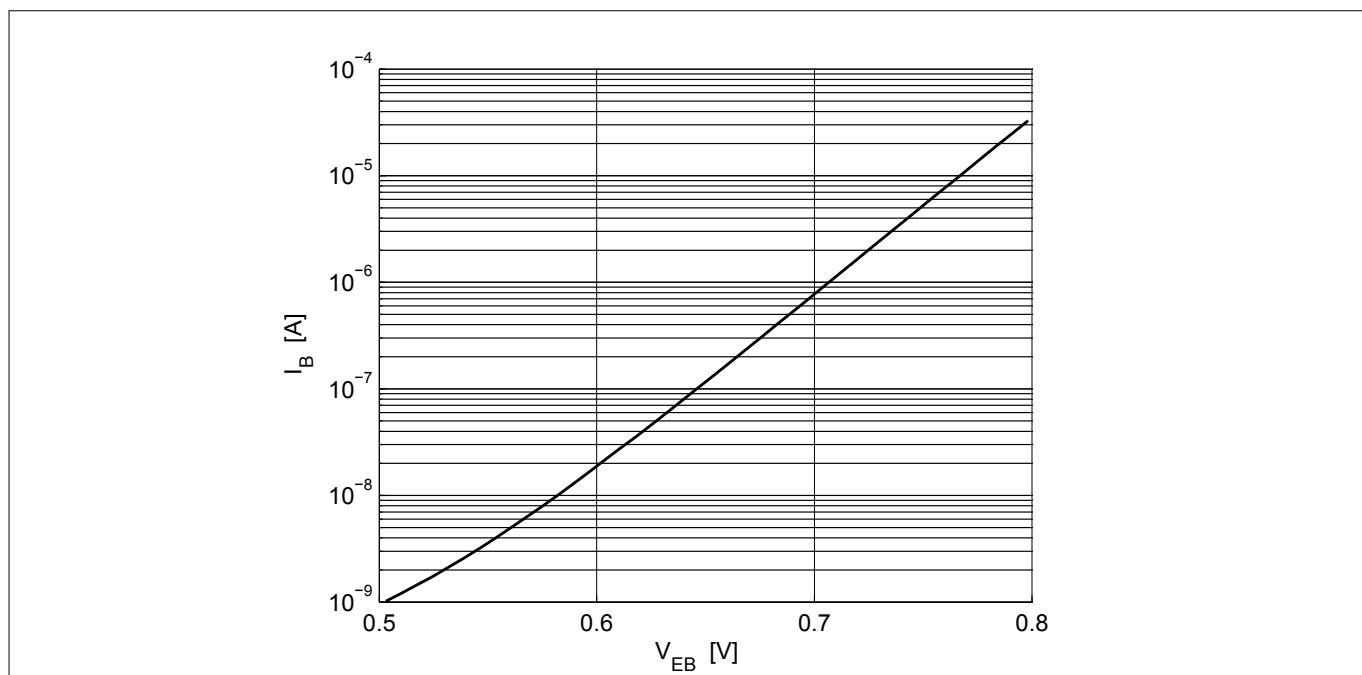


**Figure 5** Collector current vs. base emitter forward voltage  $I_C = f(V_{BE})$ ,  $V_{CE} = 2.5$  V



**Figure 6** Base current vs. base emitter forward voltage  $I_B = f(V_{BE})$ ,  $V_{CE} = 2.5$  V

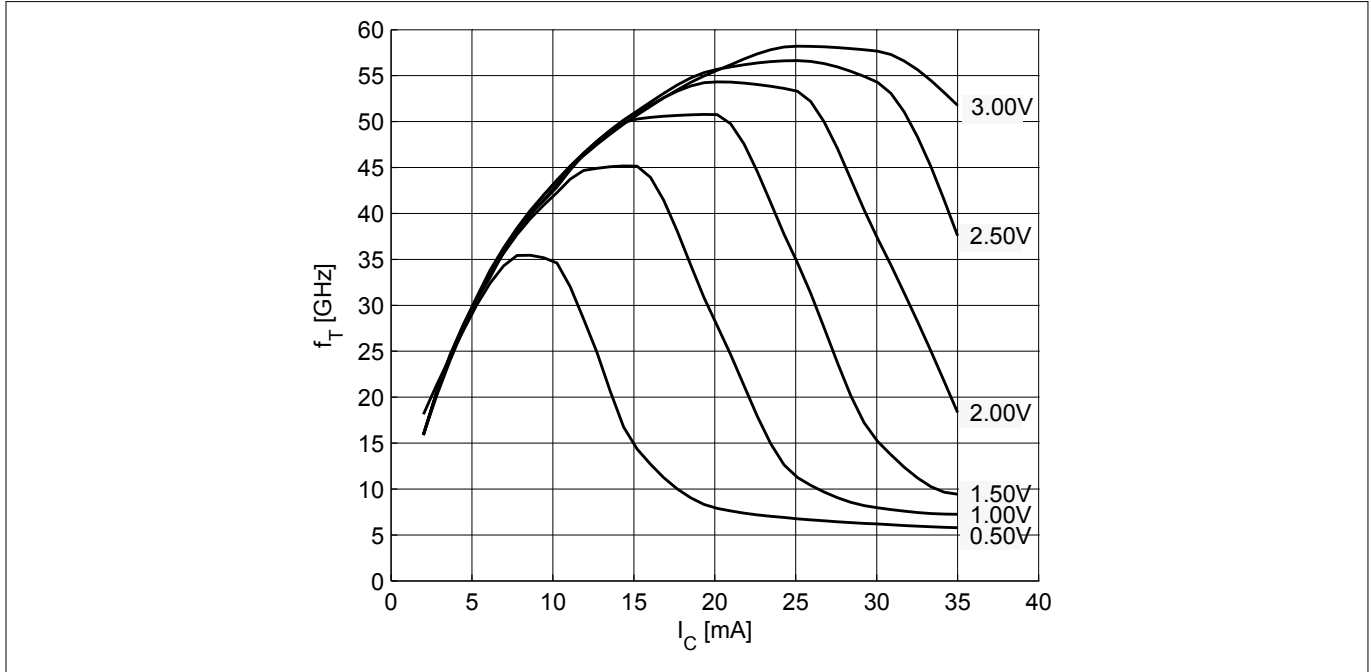
**Electrical characteristics**



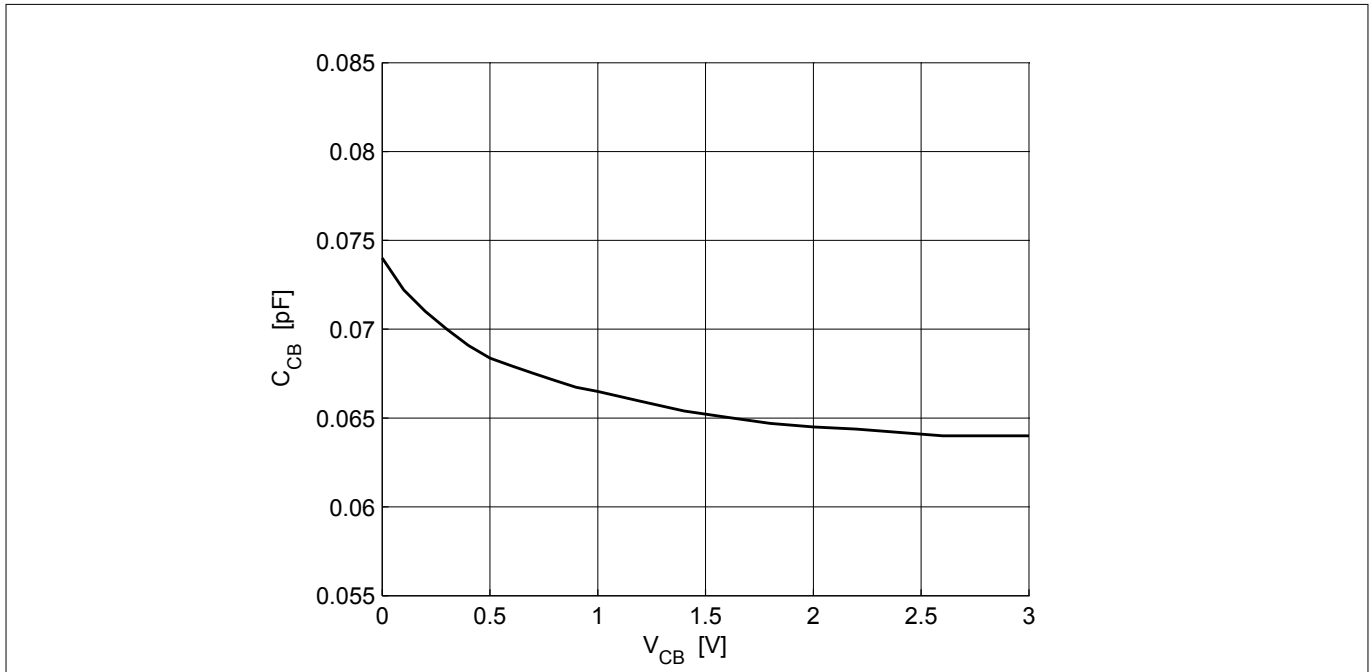
**Figure 7** Base current vs. base emitter reverse voltage  $I_B = f(V_{EB})$ ,  $V_{CE} = 2.5$  V

Electrical characteristics

**3.5 Characteristic AC diagrams**

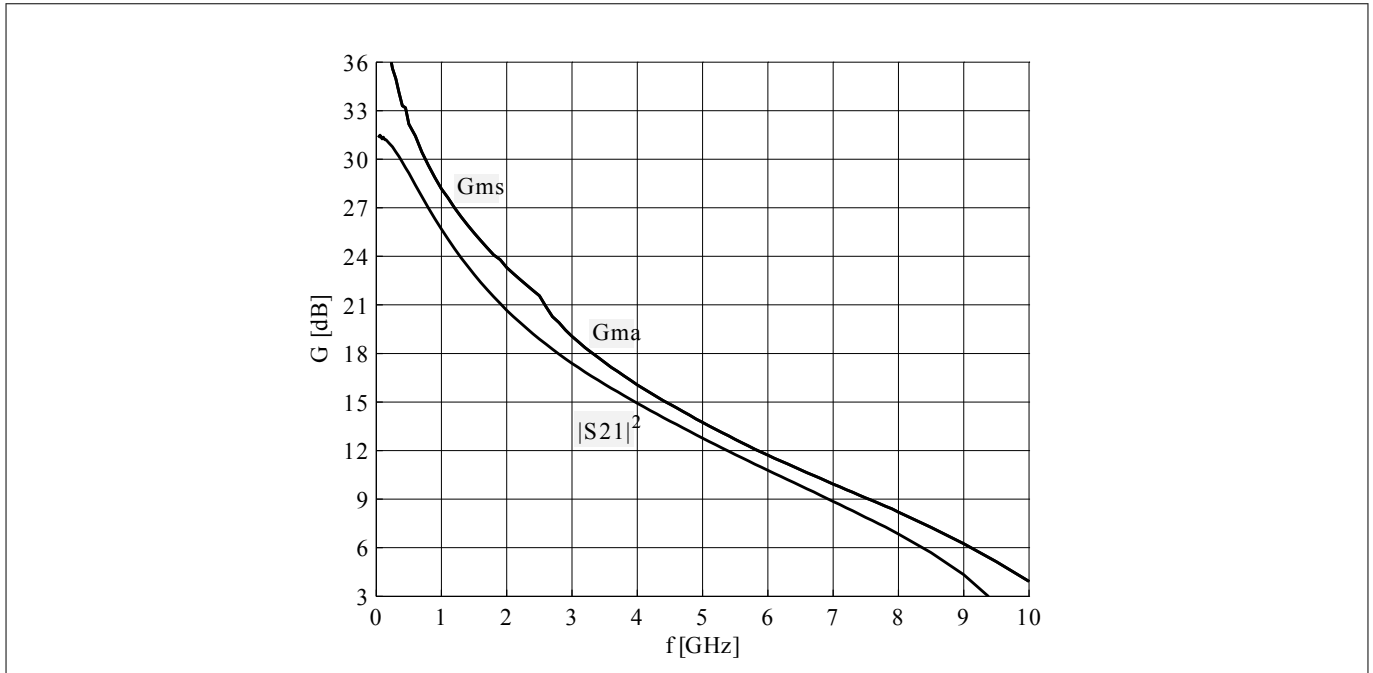


**Figure 8** Transition frequency  $f_T = f(I_C)$ ,  $f = 1$  GHz,  $V_{CE} = \text{parameter}$

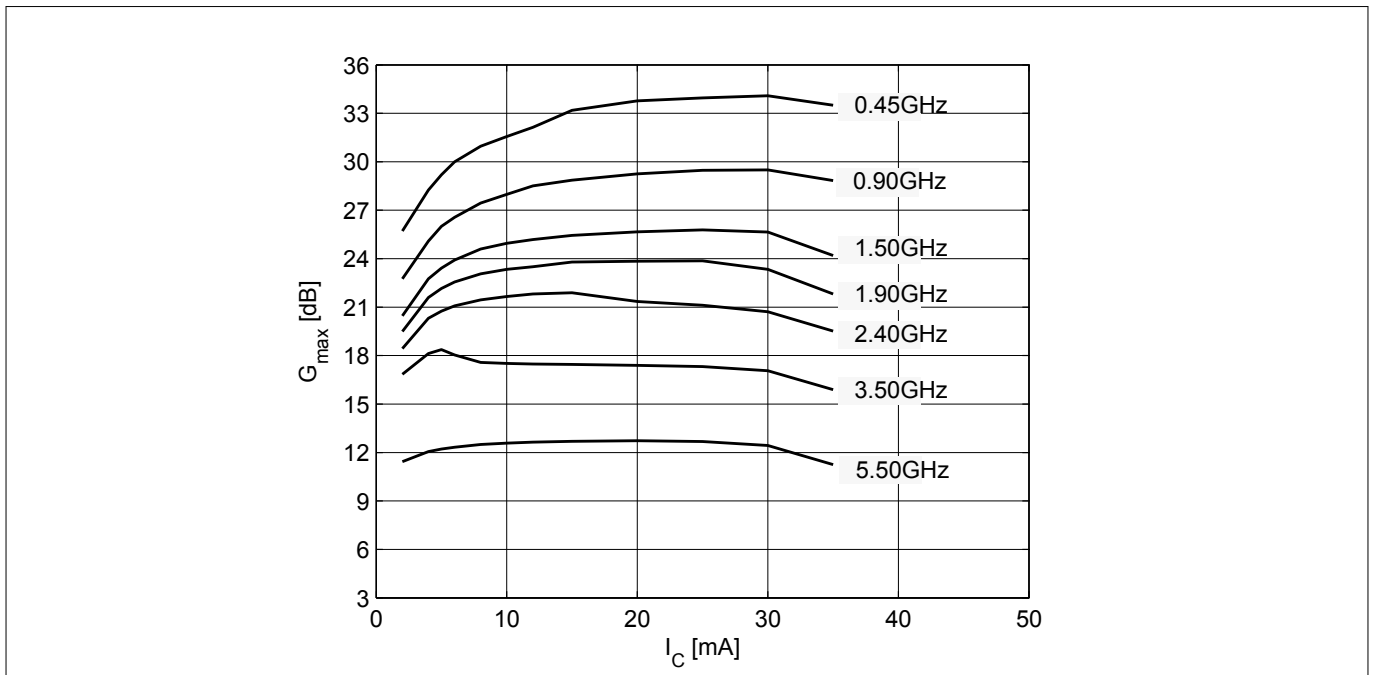


**Figure 9** Collector base capacitance  $C_{CB} = f(V_{CB})$ ,  $f = 1$  MHz

**Electrical characteristics**

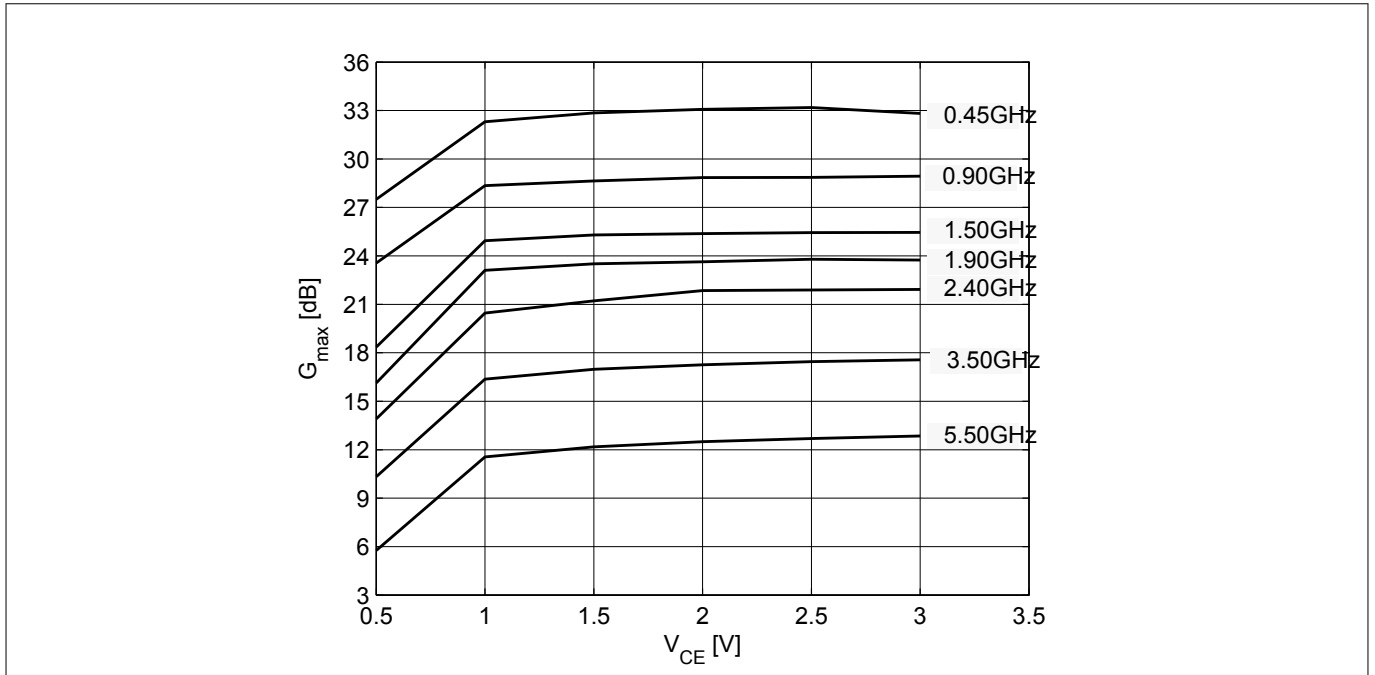


**Figure 10** Gain  $G_{ma}$ ,  $G_{ms}$ ,  $|S_{21}|^2 = f(f)$ ,  $V_{CE} = 2.5\text{ V}$ ,  $I_C = 15\text{ mA}$

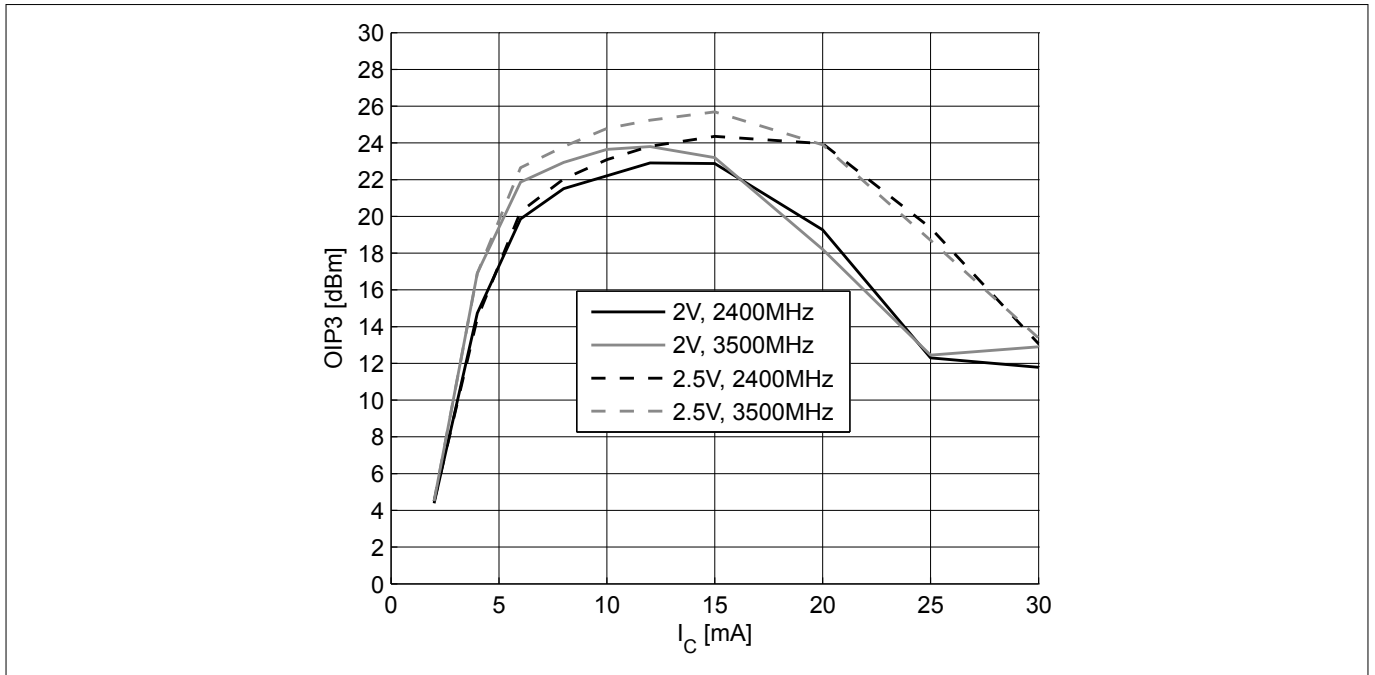


**Figure 11** Maximum power gain  $G_{max} = f(I_C)$ ,  $V_{CE} = 2.5\text{ V}$ ,  $f = \text{parameter}$

**Electrical characteristics**

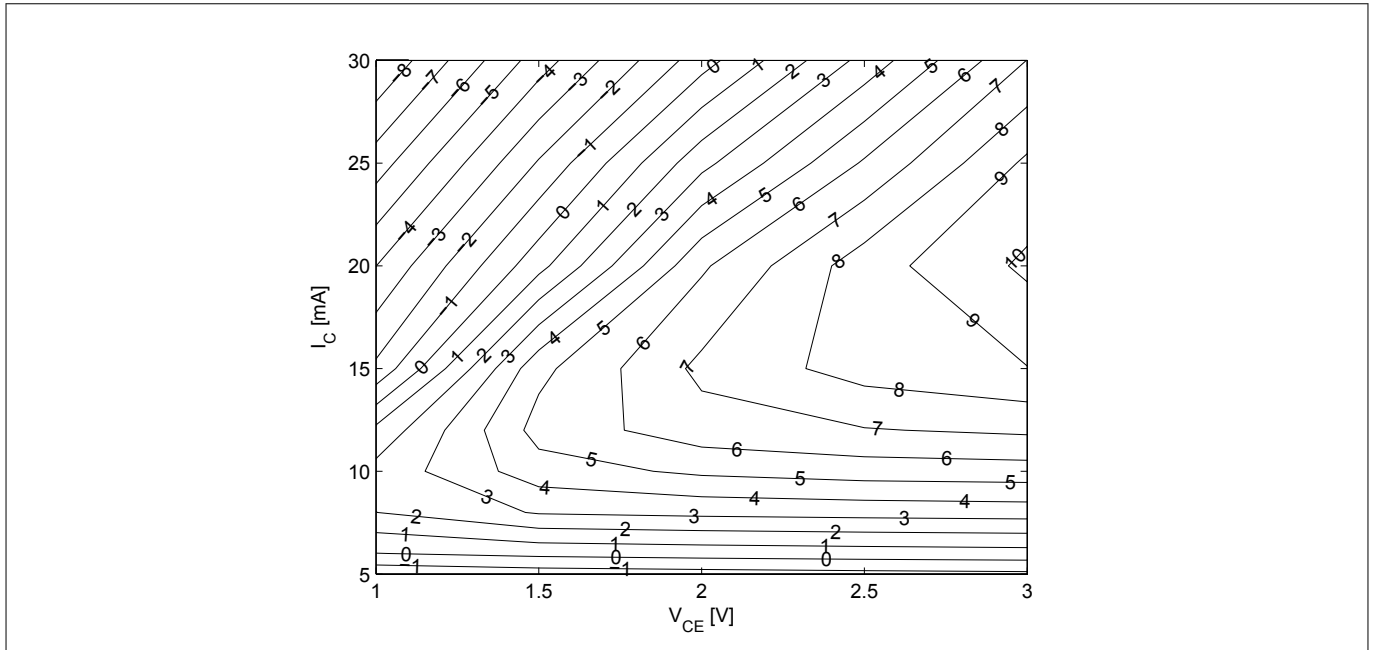


**Figure 12** Maximum power gain  $G_{max} = f(V_{CE}), I_C = 15 \text{ mA}, f = \text{parameter}$

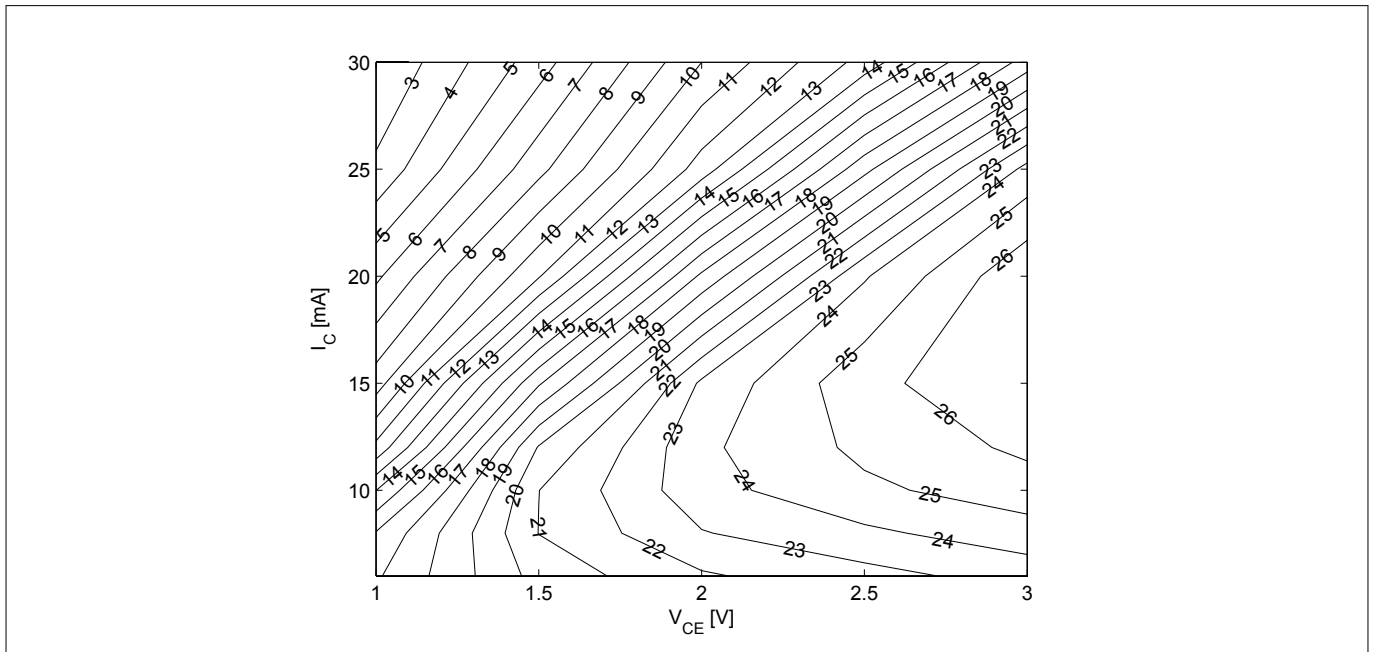


**Figure 13** 3rd order intercept point at output  $OIP_3 = f(I_C), Z_S = Z_L = 50 \Omega, V_{CE}, f = \text{parameter}$

**Electrical characteristics**

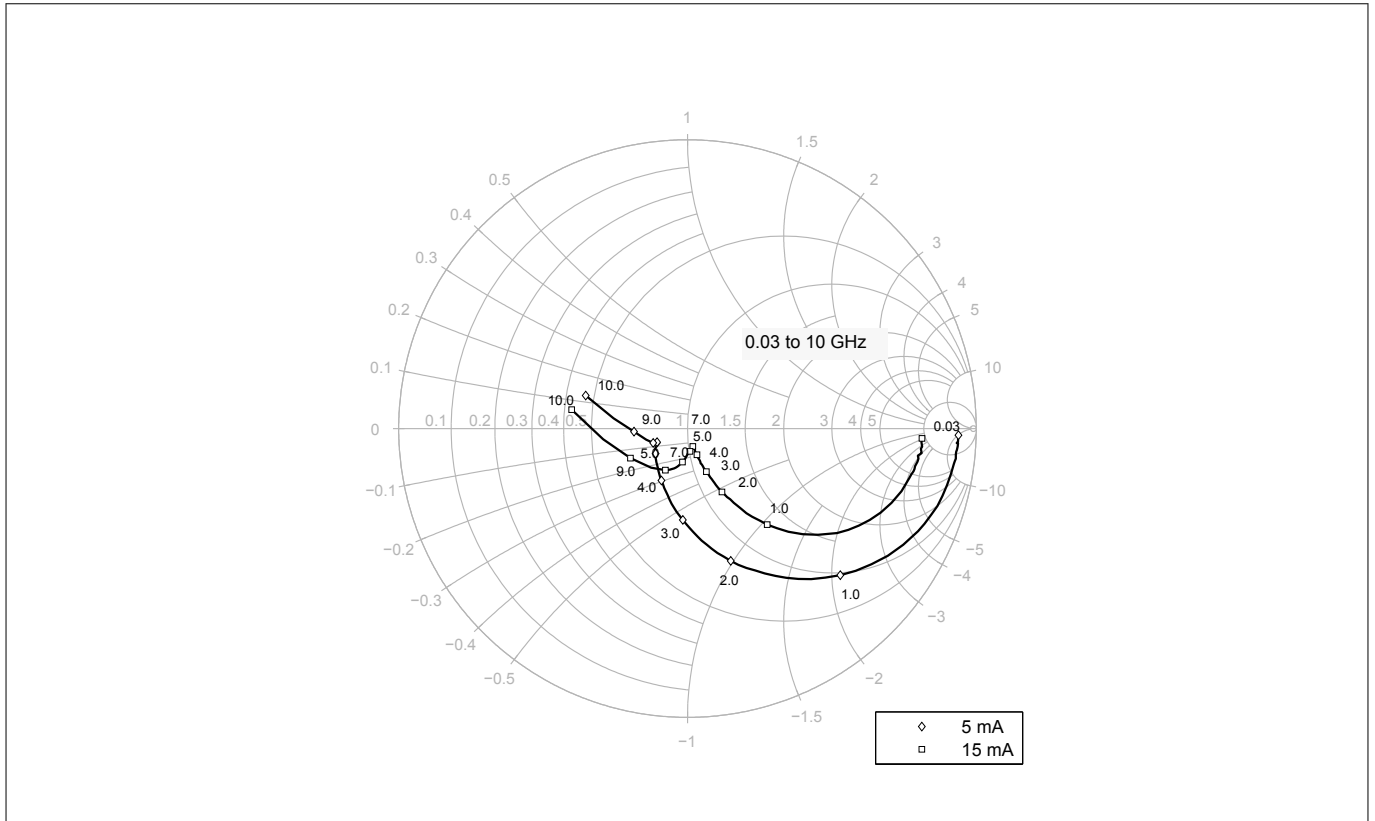


**Figure 14** Compression point at output  $OP_{1dB}$  [dBm] =  $f(I_C, V_{CE})$ ,  $Z_S = Z_L = 50 \Omega$ ,  $f = 3.5$  GHz

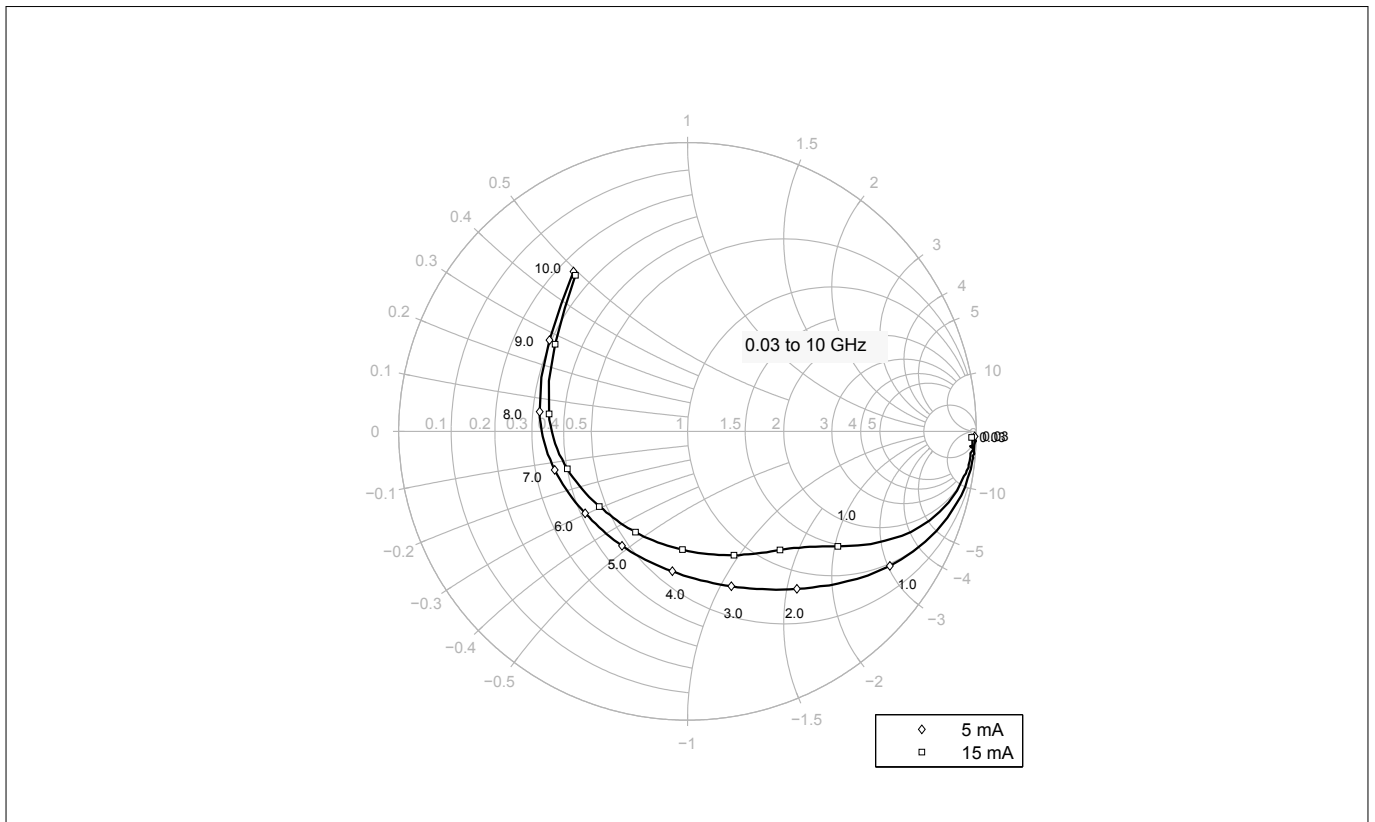


**Figure 15** 3rd order intercept point at output  $OIP_3$  [dBm] =  $f(I_C, V_{CE})$ ,  $Z_S = Z_L = 50 \Omega$ ,  $f = 3.5$  GHz

**Electrical characteristics**



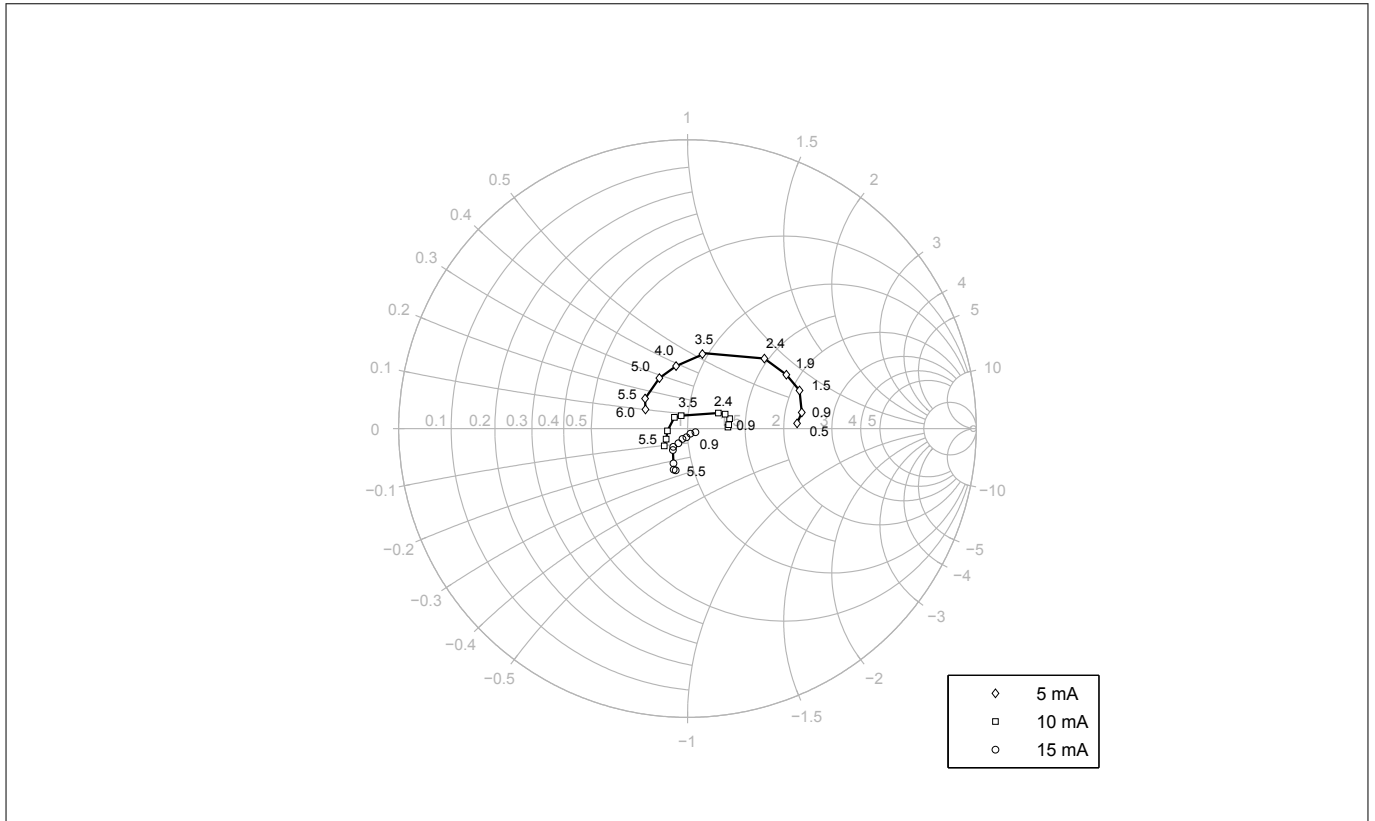
**Figure 16** Input reflection coefficient  $S_{11} = f(f)$ ,  $V_{CE} = 2.5 \text{ V}$ ,  $I_C = 5 / 15 \text{ mA}$



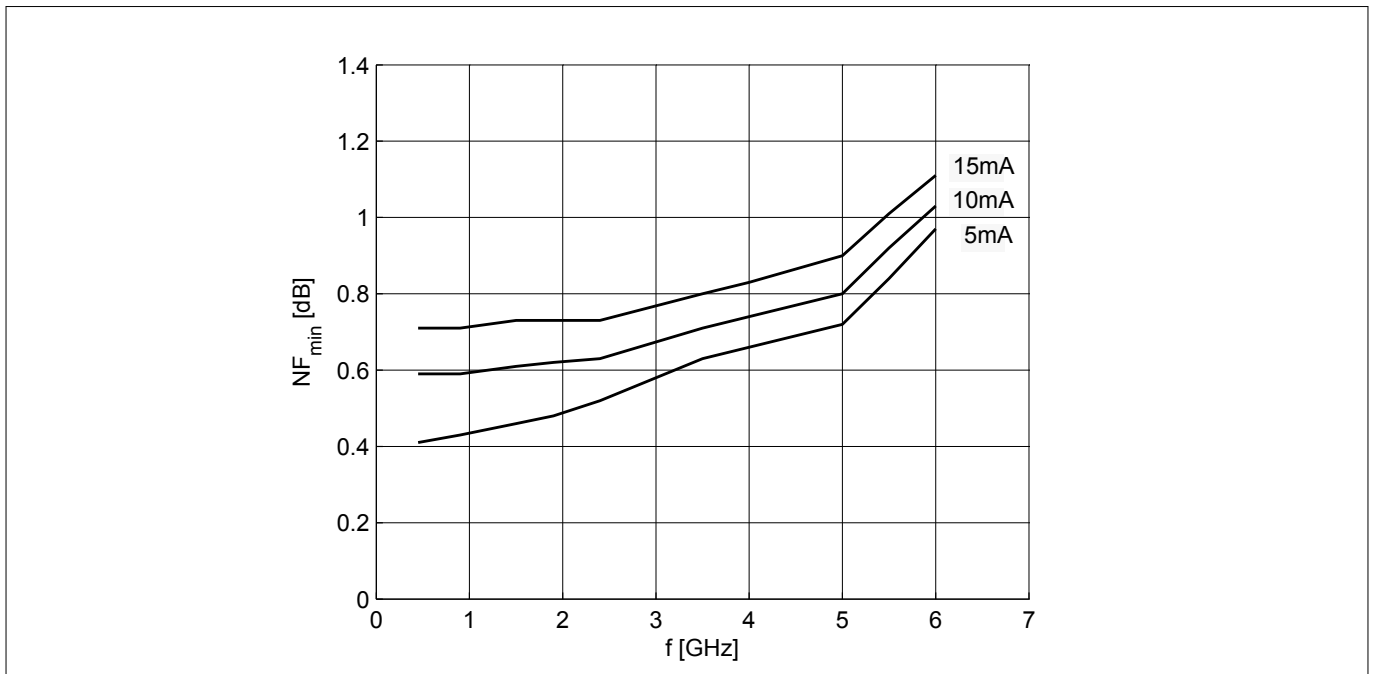
**Figure 17** Output reflection coefficient  $S_{22} = f(f)$ ,  $V_{CE} = 2.5 \text{ V}$ ,  $I_C = 5 / 15 \text{ mA}$



**Electrical characteristics**

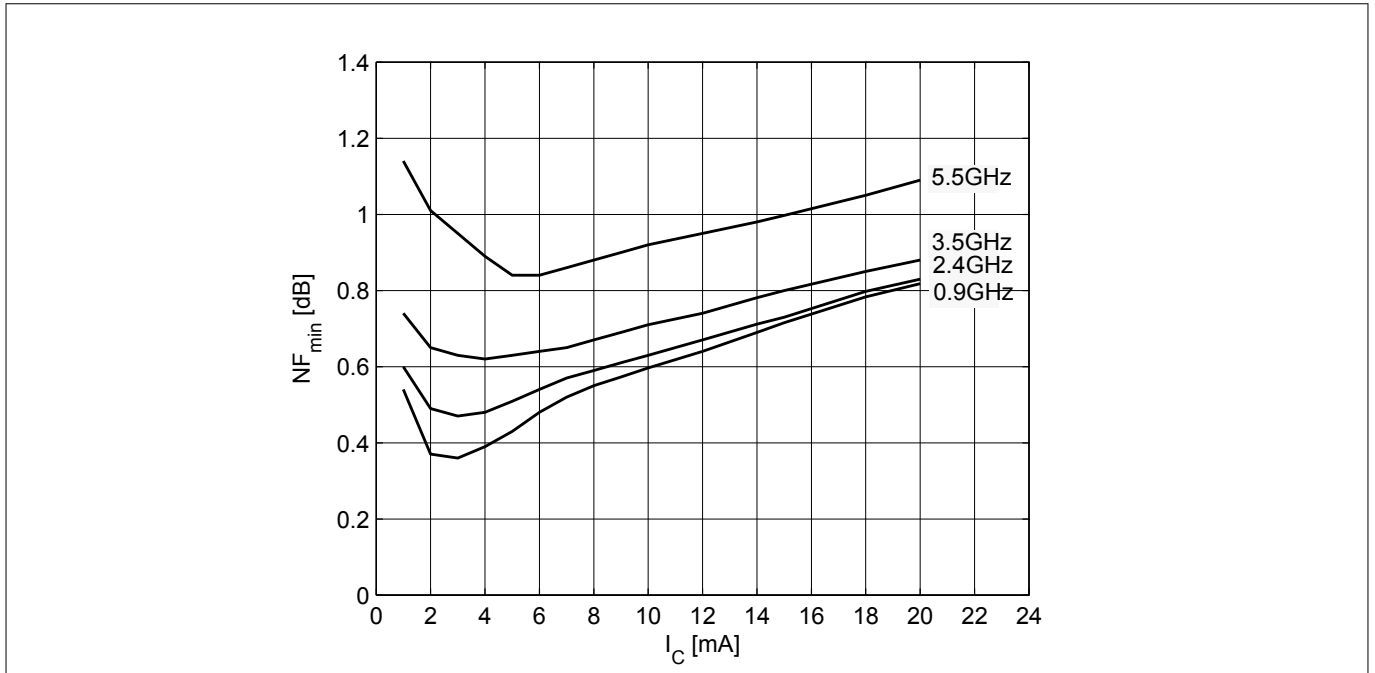


**Figure 18** Source impedance for minimum noise figure  $Z_{S,opt} = f(f)$ ,  $V_{CE} = 2.5 \text{ V}$ ,  $I_C = 5 / 10 / 15 \text{ mA}$

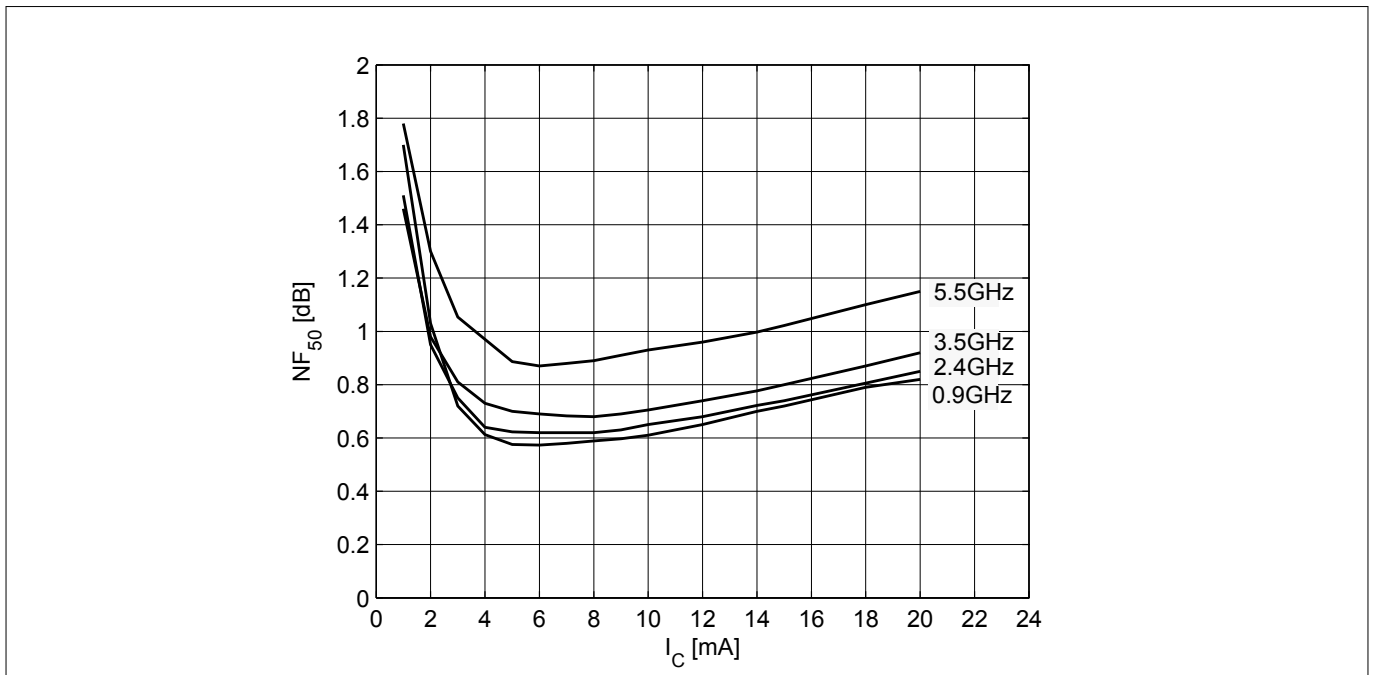


**Figure 19** Noise figure  $NF_{min} = f(f)$ ,  $V_{CE} = 2.5 \text{ V}$ ,  $Z_S = Z_{S,opt}$ ,  $I_C = 5 / 10 / 15 \text{ mA}$

**Electrical characteristics**



**Figure 20** Noise figure  $NF_{min} = f(I_C)$ ,  $V_{CE} = 2.5\text{ V}$ ,  $Z_S = Z_{S,opt}$ ,  $f = \text{parameter}$

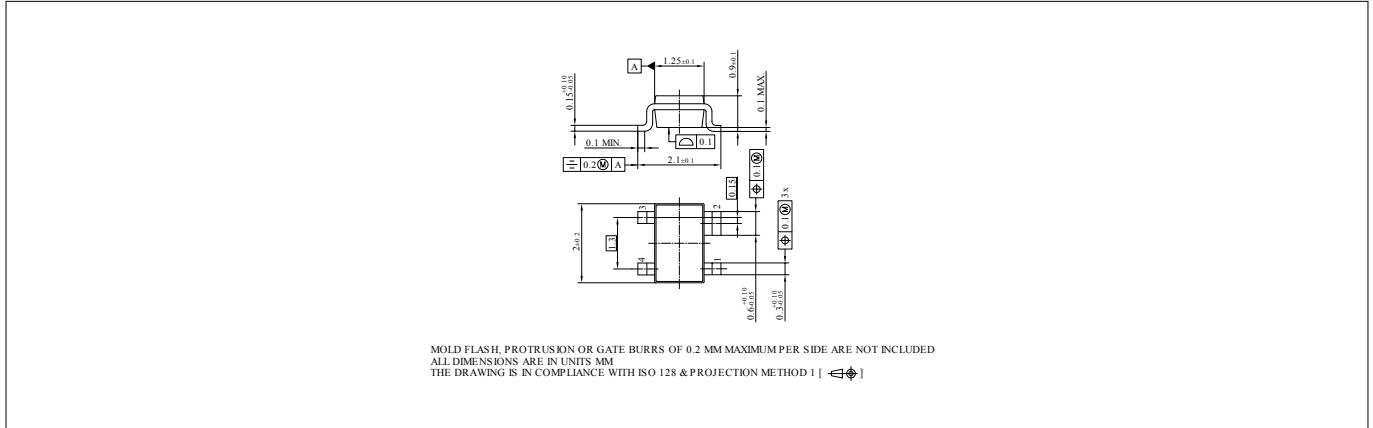


**Figure 21** Noise figure  $NF_{50} = f(I_C)$ ,  $V_{CE} = 2.5\text{ V}$ ,  $Z_S = 50\ \Omega$ ,  $f = \text{parameter}$

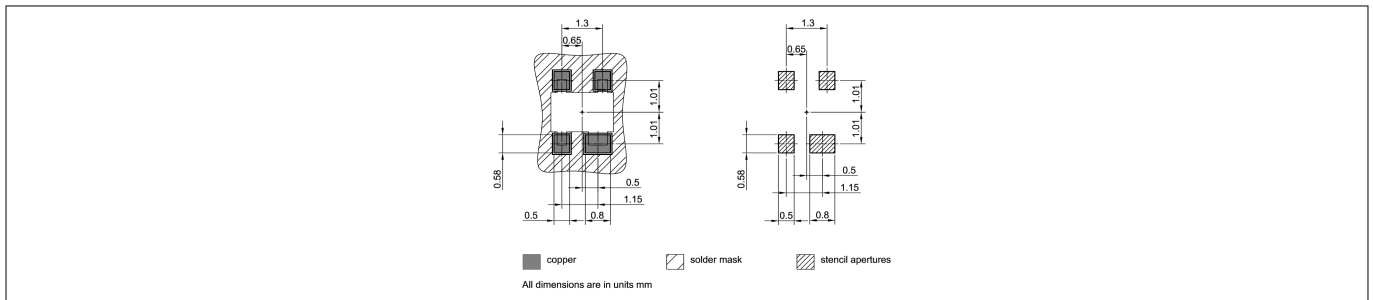
*Note:* The curves shown in this chapter have been generated using typical devices but shall not be considered as a guarantee that all devices have identical characteristic curves.  $T_A = 25\text{ }^\circ\text{C}$ .

Package information SOT343

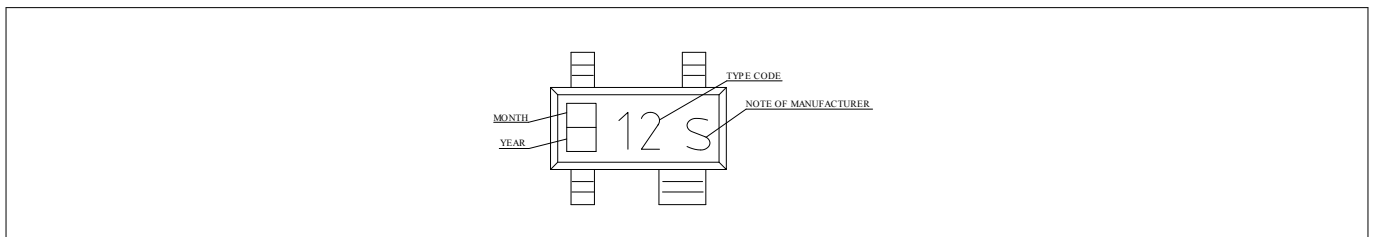
**4 Package information SOT343**



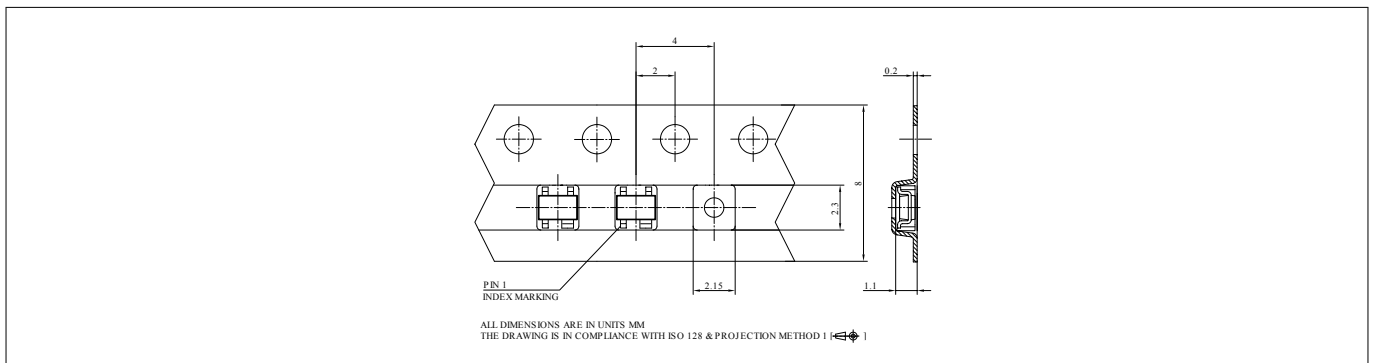
**Figure 22 Package outline**



**Figure 23 Foot print**



**Figure 24 Marking layout example**



**Figure 25 Tape dimensions**

---

Revision history

## Revision history

| Document version | Date of release | Description of changes |
|------------------|-----------------|------------------------|
| 2.0              | 2018-09-26      | New datasheet layout.  |