

# BFP843

## Robust low noise broadband pre-matched RF bipolar transistor



Order now



Technical documents



Simulation



Support

## Product description

The BFP843 is a robust low noise broadband pre-matched RF heterojunction bipolar transistor (HBT).



## Feature list

- Unique combination of high end RF performance and robustness: 20 dBm maximum RF input power, 1.5 kV HBM ESD hardness
- High transition frequency enables best in class noise performance at high frequencies:  
 $NF_{min} = 1.2$  dB at 5.5 GHz, 1.8 V, 8 mA
- High gain  $G_{ma} = 17$  dB at 5.5 GHz, 1.8 V, 15 mA
- $OIP_3 = 19.5$  dBm at 5.5 GHz, 1.8 V, 15 mA
- Suitable for low voltage applications e.g.  $V_{CC} = 1.2$  V and 1.8 V (2.85 V, 3.3 V, 3.6 V require a corresponding collector resistor)

## Product validation

Qualified for industrial applications according to the relevant tests of JEDEC47/20/22.

## Potential applications

- WLAN, WiMAX and UWB
- Satellite communication systems: satellite radio (SDARs, DAB) and navigation systems (e.g. GPS, GLONASS, BeiDou, Galileo)

## Device information

**Table 1** Part information

Product name / Ordering code	Package	Pin configuration				Marking	Pieces / Reel
BFP843 / BFP843H6327XTSA1	SOT343	1 = B	2 = E	3 = C	4 = E	T2s	3000

**Attention:** ESD (Electrostatic discharge) sensitive device, observe handling precautions

## Table of contents

	<b>Product description</b> .....	1
	<b>Feature list</b> .....	1
	<b>Product validation</b> .....	1
	<b>Potential applications</b> .....	1
	<b>Device information</b> .....	1
	<b>Table of contents</b> .....	2
<b>1</b>	<b>Absolute maximum ratings</b> .....	3
<b>2</b>	<b>Thermal characteristics</b> .....	4
<b>3</b>	<b>Electrical characteristics</b> .....	5
3.1	DC characteristics .....	5
3.2	General AC characteristics .....	5
3.3	Frequency dependent AC characteristics .....	6
3.4	Characteristic DC diagrams .....	10
3.5	Characteristic AC diagrams .....	13
<b>4</b>	<b>Package information SOT343</b> .....	19
	<b>Revision history</b> .....	20
	<b>Disclaimer</b> .....	21

---

**Absolute maximum ratings**

# 1 Absolute maximum ratings

**Table 2 Absolute maximum ratings at  $T_A = 25\text{ °C}$  (unless otherwise specified)**

Parameter	Symbol	Values		Unit	Note or test condition
		Min.	Max.		
Collector emitter voltage	$V_{CEO}$	–	2.25	V	Open base
			2.0		$T_A = -55\text{ °C}$ , open base
Collector emitter voltage <sup>1)</sup>	$V_{CES}$	–	2.25		E-B short circuited
			2.0		$T_A = -55\text{ °C}$ , E-B short circuited
Collector base voltage <sup>2)</sup>	$V_{CBO}$	–	2.9		Open emitter
			2.6		$T_A = -55\text{ °C}$ , open emitter
Base current	$I_B$	-5	5	mA	–
Collector current	$I_C$	–	55		
RF input power	$P_{RFIn}$	–	20	dBm	
ESD stress pulse	$V_{ESD}$	-1.5	1.5	kV	HBM, all pins, acc. to JESD22-A114
Total power dissipation <sup>3)</sup>	$P_{tot}$	–	125	mW	$T_S \leq 99\text{ °C}$
Junction temperature	$T_J$	–	150	°C	–
Storage temperature	$T_{Stg}$	-55			

**Attention:** Stresses above the max. values listed here may cause permanent damage to the device. Exposure to absolute maximum rating conditions for extended periods may affect device reliability. Exceeding only one of these values may cause irreversible damage to the integrated circuit.

<sup>1</sup>  $V_{CES}$  is similar to  $V_{CEO}$  due to design.

<sup>2</sup>  $V_{CBO}$  is similar to  $V_{CEO}$  due to design.

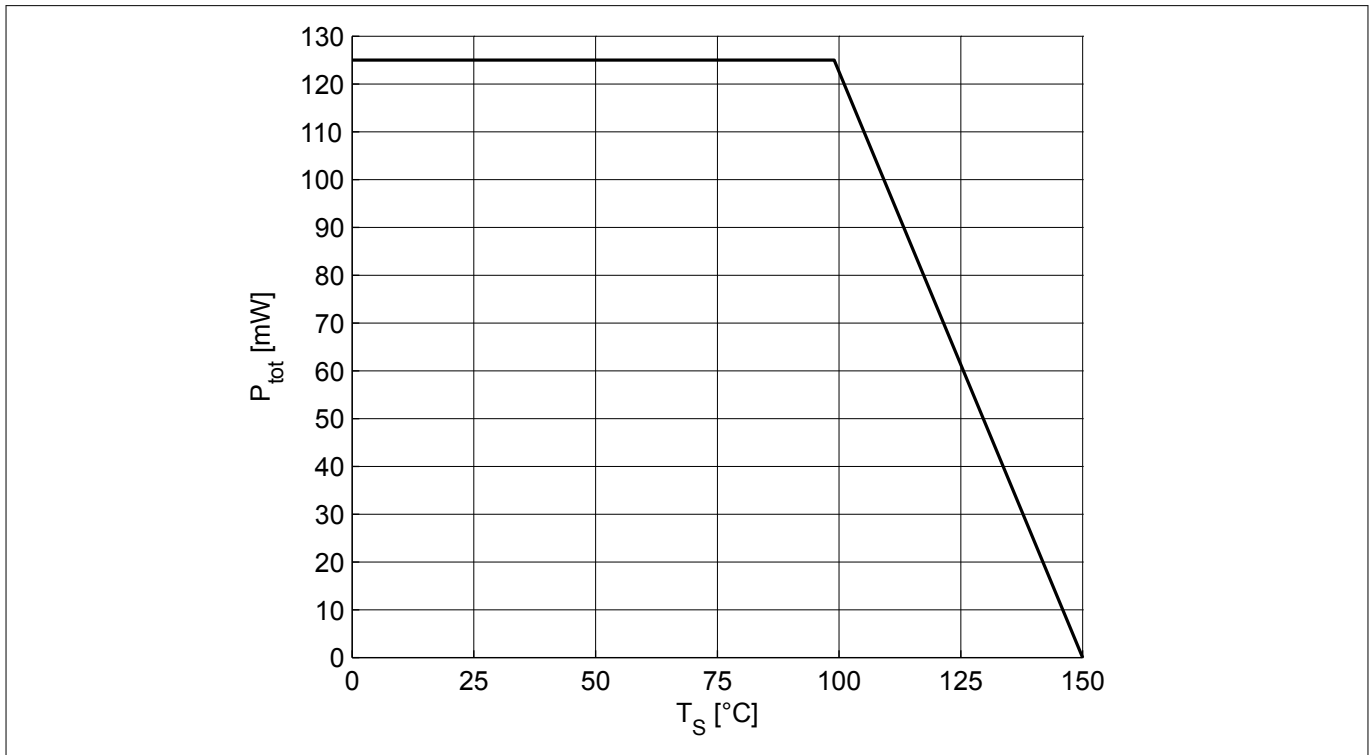
<sup>3</sup>  $T_S$  is the soldering point temperature.  $T_S$  is measured on the emitter lead at the soldering point of the PCB.

Thermal characteristics

## 2 Thermal characteristics

**Table 3 Thermal resistance**

Parameter	Symbol	Values			Unit	Note or test condition
		Min.	Typ.	Max.		
Junction - soldering point	$R_{thJS}$	–	405	–	K/W	–



**Figure 1 Total power dissipation  $P_{tot} = f(T_S)$**

---

**Electrical characteristics**

### 3 Electrical characteristics

#### 3.1 DC characteristics

**Table 4 DC characteristics at  $T_A = 25\text{ °C}$** 

Parameter	Symbol	Values			Unit	Note or test condition
		Min.	Typ.	Max.		
Collector emitter breakdown voltage	$V_{(BR)CEO}$	2.25	2.6	–	V	$I_C = 1\text{ mA}$ , $I_B = 0$ , open base
Collector emitter leakage current	$I_{CES}$	–	–	400 <sup>1)</sup>	nA	$V_{CE} = 1.5\text{ V}$ , $V_{BE} = 0$ , E-B short circuited
Collector base leakage current	$I_{CBO}$			400 <sup>1)</sup>		$V_{CB} = 1.5\text{ V}$ , $I_E = 0$ , open emitter
Emitter base leakage current	$I_{EBO}$			10 <sup>1)</sup>	$\mu\text{A}$	$V_{EB} = 0.5\text{ V}$ , $I_C = 0$ , open collector
DC current gain	$h_{FE}$	150	260	450	–	$V_{CE} = 1.8\text{ V}$ , $I_C = 15\text{ mA}$ , pulse measured

#### 3.2 General AC characteristics

**Table 5 General AC characteristics at  $T_A = 25\text{ °C}$** 

Parameter	Symbol	Values			Unit	Note or test condition
		Min.	Typ.	Max.		
Collector base capacitance <sup>2)</sup>	$C_{CB}$	–	5.23 0.06	–	pF	$f = 1\text{ MHz}$ , $f = 1\text{ GHz}$ , $V_{CB} = 1.8\text{ V}$ , $V_{BE} = 0$ , emitter grounded
Collector emitter capacitance	$C_{CE}$		0.5			$f = 1\text{ MHz}$ , $V_{CE} = 1.8\text{ V}$ , $V_{BE} = 0$ , base grounded
Emitter base capacitance	$C_{EB}$		0.73			$f = 1\text{ MHz}$ , $V_{EB} = 0.4\text{ V}$ , $V_{CB} = 0$ , collector grounded

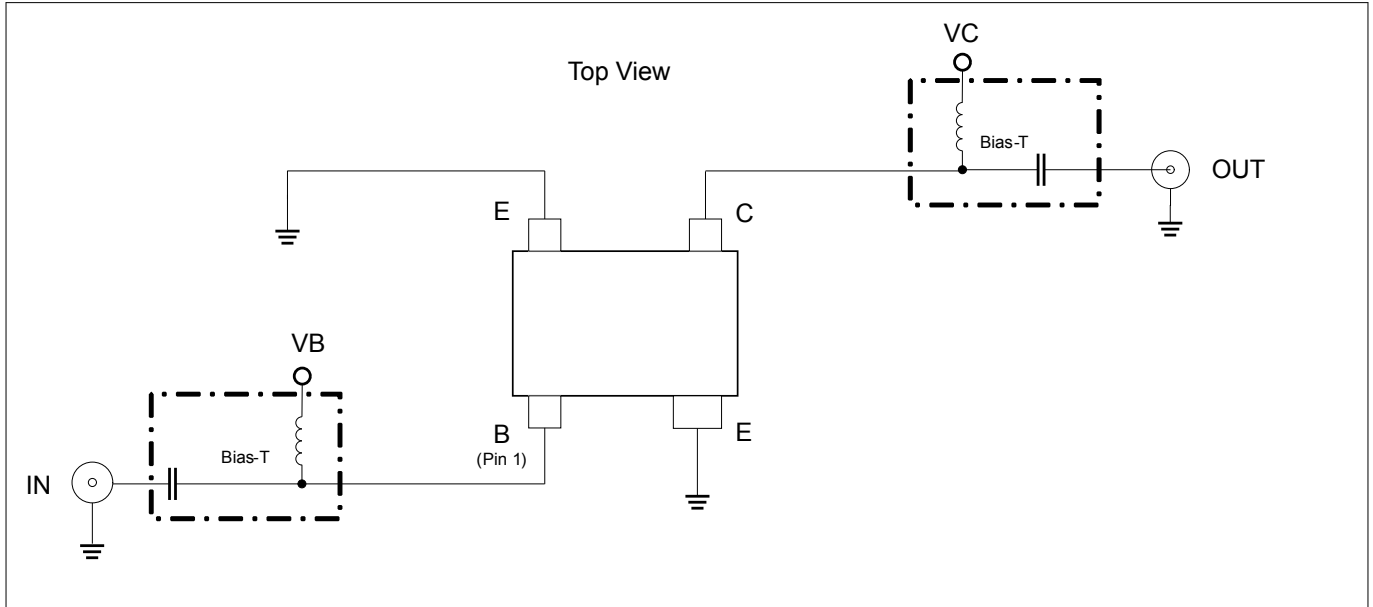
<sup>1</sup> Maximum values not limited by the device but by the short cycle time of the 100% test

<sup>2</sup> Including integrated feedback capacitance

**Electrical characteristics**

**3.3 Frequency dependent AC characteristics**

Measurement setup is a test fixture with Bias-T's in a 50 Ω system,  $T_A = 25\text{ °C}$ .



**Figure 2 Testing circuit**

**Table 6 AC characteristics,  $V_{CE} = 1.8\text{ V}$ ,  $f = 450\text{ MHz}$**

Parameter	Symbol	Values			Unit	Note or test condition
		Min.	Typ.	Max.		
Power gain		-		-	dB	$I_C = 15\text{ mA}$
• Maximum power gain	$G_{ma}$		24.5			
• Transducer gain	$ S_{21} ^2$		24.5			
Noise figure						$I_C = 8\text{ mA}$
• Minimum noise figure	$NF_{min}$		0.9			
• Associated gain	$G_{ass}$		22			
Linearity					dBm	$I_C = 15\text{ mA}$ , $Z_S = Z_L = 50\text{ }\Omega$
• 3rd order intercept point at output	$OIP_3$		24			
• 1 dB gain compression point at output	$OP_{1dB}$		7			

**Electrical characteristics**

**Table 7 AC characteristics,  $V_{CE} = 1.8\text{ V}$ ,  $f = 900\text{ MHz}$**

Parameter	Symbol	Values			Unit	Note or test condition
		Min.	Typ.	Max.		
Power gain		-		-	dB	$I_C = 15\text{ mA}$
<ul style="list-style-type: none"> <li>Maximum power gain</li> <li>Transducer gain</li> </ul>	$G_{ma}$ $ S_{21} ^2$		 24			
Noise figure						$I_C = 8\text{ mA}$
<ul style="list-style-type: none"> <li>Minimum noise figure</li> <li>Associated gain</li> </ul>	$NF_{min}$ $G_{ass}$		 0.9 22			
Linearity					dBm	$I_C = 15\text{ mA}$ , $Z_S = Z_L = 50\ \Omega$
<ul style="list-style-type: none"> <li>3rd order intercept point at output</li> <li>1 dB gain compression point at output</li> </ul>	$OIP_3$ $OP_{1dB}$		 23.5 8			

**Table 8 AC characteristics,  $V_{CE} = 1.8\text{ V}$ ,  $f = 1.5\text{ GHz}$**

Parameter	Symbol	Values			Unit	Note or test condition
		Min.	Typ.	Max.		
Power gain		-		-	dB	$I_C = 15\text{ mA}$
<ul style="list-style-type: none"> <li>Maximum power gain</li> <li>Transducer gain</li> </ul>	$G_{ma}$ $ S_{21} ^2$		 23.5 23			
Noise figure						$I_C = 8\text{ mA}$
<ul style="list-style-type: none"> <li>Minimum noise figure</li> <li>Associated gain</li> </ul>	$NF_{min}$ $G_{ass}$		 0.95 21			
Linearity					dBm	$I_C = 15\text{ mA}$ , $Z_S = Z_L = 50\ \Omega$
<ul style="list-style-type: none"> <li>3rd order intercept point at output</li> <li>1 dB gain compression point at output</li> </ul>	$OIP_3$ $OP_{1dB}$		 22.5 6			

**Table 9 AC characteristics,  $V_{CE} = 1.8\text{ V}$ ,  $f = 1.9\text{ GHz}$**

Parameter	Symbol	Values			Unit	Note or test condition
		Min.	Typ.	Max.		
Power gain		-		-	dB	$I_C = 15\text{ mA}$
<ul style="list-style-type: none"> <li>Maximum power gain</li> <li>Transducer gain</li> </ul>	$G_{ma}$ $ S_{21} ^2$		 22.5 22			
Noise figure						$I_C = 8\text{ mA}$
<ul style="list-style-type: none"> <li>Minimum noise figure</li> <li>Associated gain</li> </ul>	$NF_{min}$ $G_{ass}$		 0.95 20			
Linearity					dBm	$I_C = 15\text{ mA}$ , $Z_S = Z_L = 50\ \Omega$
<ul style="list-style-type: none"> <li>3rd order intercept point at output</li> <li>1 dB gain compression point at output</li> </ul>	$OIP_3$ $OP_{1dB}$		 24 8.5			

---

**Electrical characteristics**
**Table 10 AC characteristics,  $V_{CE} = 1.8\text{ V}$ ,  $f = 2.4\text{ GHz}$** 

Parameter	Symbol	Values			Unit	Note or test condition
		Min.	Typ.	Max.		
Power gain		–		–	dB	$I_C = 15\text{ mA}$
<ul style="list-style-type: none"> <li>Maximum power gain</li> <li>Transducer gain</li> </ul>	$G_{ma}$ $ S_{21} ^2$		21.5 21			
Noise figure						dBm
<ul style="list-style-type: none"> <li>Minimum noise figure</li> <li>Associated gain</li> </ul>	$NF_{min}$ $G_{ass}$	1.0 19.5				
Linearity					$I_C = 15\text{ mA}$ , $Z_S = Z_L = 50\ \Omega$	
<ul style="list-style-type: none"> <li>3rd order intercept point at output</li> <li>1 dB gain compression point at output</li> </ul>	$OIP_3$ $OP_{1dB}$	22 6.5				

**Table 11 AC characteristics,  $V_{CE} = 1.8\text{ V}$ ,  $f = 3.5\text{ GHz}$** 

Parameter	Symbol	Values			Unit	Note or test condition
		Min.	Typ.	Max.		
Power gain		–		–	dB	$I_C = 15\text{ mA}$
<ul style="list-style-type: none"> <li>Maximum power gain</li> <li>Transducer gain</li> </ul>	$G_{ma}$ $ S_{21} ^2$		19.5 19			
Noise figure						dBm
<ul style="list-style-type: none"> <li>Minimum noise figure</li> <li>Associated gain</li> </ul>	$NF_{min}$ $G_{ass}$	1.1 17.5				
Linearity					$I_C = 15\text{ mA}$ , $Z_S = Z_L = 50\ \Omega$	
<ul style="list-style-type: none"> <li>3rd order intercept point at output</li> <li>1 dB gain compression point at output</li> </ul>	$OIP_3$ $OP_{1dB}$	22.5 7				

**Table 12 AC characteristics,  $V_{CE} = 1.8\text{ V}$ ,  $f = 5.5\text{ GHz}$** 

Parameter	Symbol	Values			Unit	Note or test condition
		Min.	Typ.	Max.		
Power gain		–		–	dB	$I_C = 15\text{ mA}$
<ul style="list-style-type: none"> <li>Maximum power gain</li> <li>Transducer gain</li> </ul>	$G_{ma}$ $ S_{21} ^2$		17 15.5			
Noise figure						dBm
<ul style="list-style-type: none"> <li>Minimum noise figure</li> <li>Associated gain</li> </ul>	$NF_{min}$ $G_{ass}$	1.2 15				
Linearity					$I_C = 15\text{ mA}$ , $Z_S = Z_L = 50\ \Omega$	
<ul style="list-style-type: none"> <li>3rd order intercept point at output</li> <li>1 dB gain compression point at output</li> </ul>	$OIP_3$ $OP_{1dB}$	19.5 4				



---

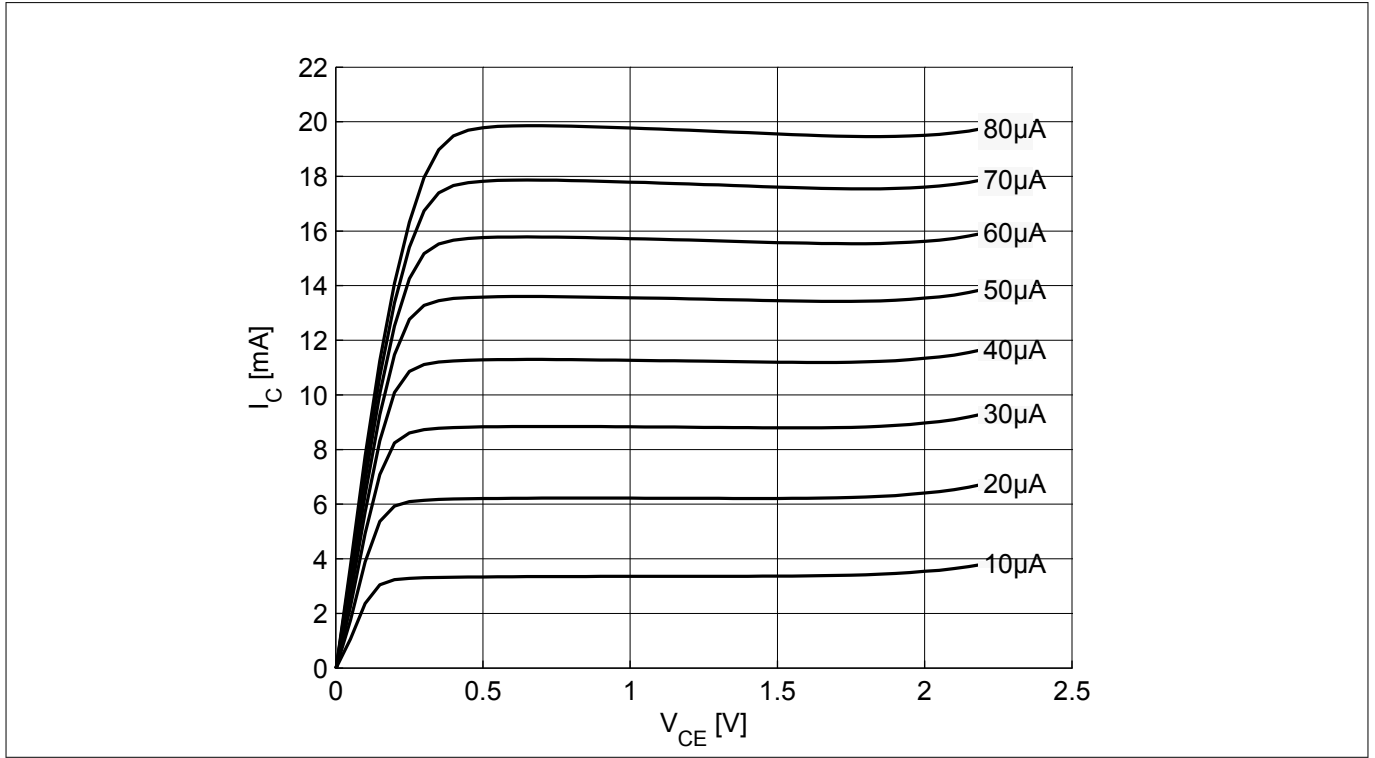
**Electrical characteristics**
**Table 13 AC characteristics,  $V_{CE} = 1.8 \text{ V}$ ,  $f = 10 \text{ GHz}$** 

Parameter	Symbol	Values			Unit	Note or test condition	
		Min.	Typ.	Max.			
Power gain		–		–	dB	$I_C = 15 \text{ mA}$	
<ul style="list-style-type: none"> <li>Maximum power gain</li> <li>Transducer gain</li> </ul>	$G_{ma}$ $ S_{21} ^2$		 13.5 8.5				
Noise figure						dB	$I_C = 8 \text{ mA}$
<ul style="list-style-type: none"> <li>Minimum noise figure</li> <li>Associated gain</li> </ul>	$NF_{min}$ $G_{ass}$		 1.85 9				
Linearity				dBm	$I_C = 15 \text{ mA}$ , $Z_S = Z_L = 50 \Omega$		
<ul style="list-style-type: none"> <li>3rd order intercept point at output</li> <li>1 dB gain compression point at output</li> </ul>	$OIP_3$ $OP_{1dB}$	 16 0					

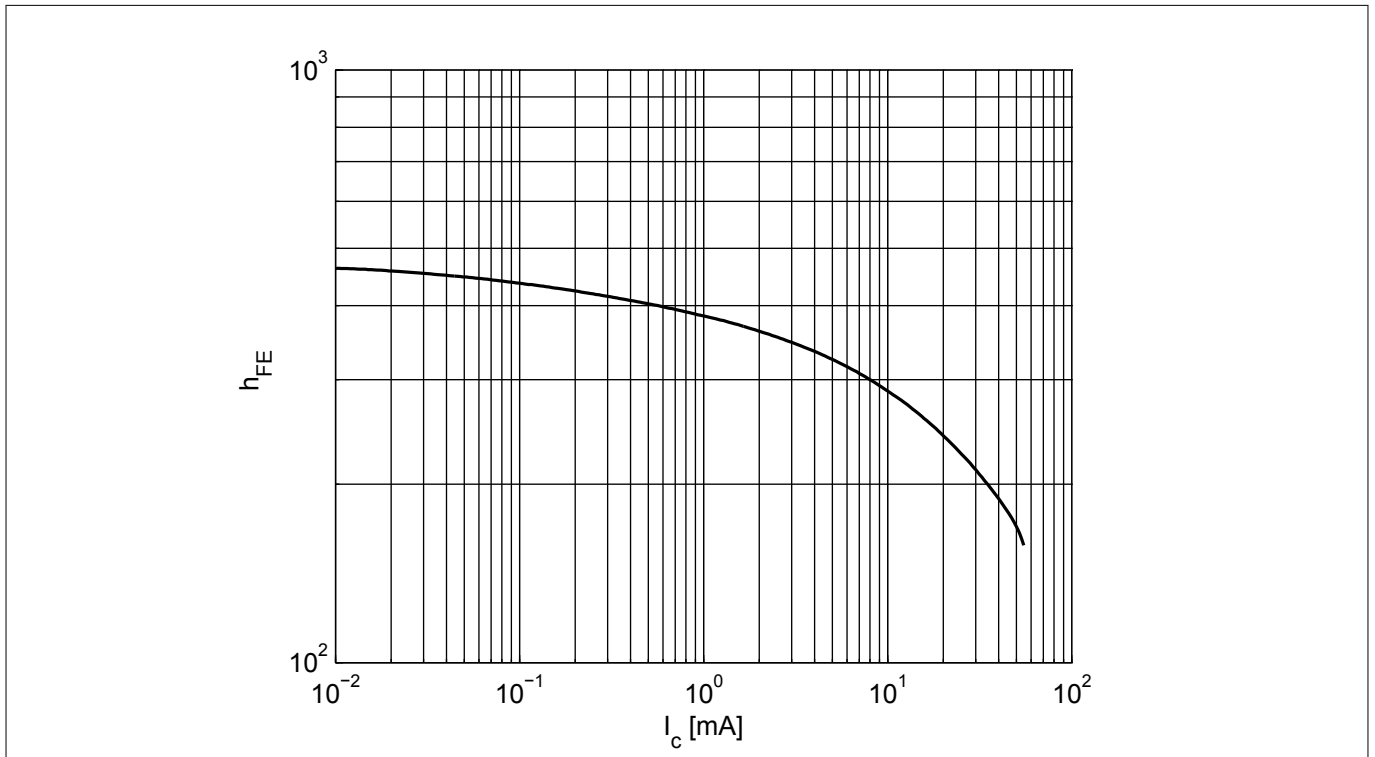
Note:  $G_{ms} = |S_{21}/S_{12}|$  for  $k < 1$ ;  $G_{ma} = |S_{21}/S_{12}|(k-(k^2-1)^{1/2})$  for  $k > 1$ . In order to get the  $NF_{min}$  values stated in this chapter, the test fixture losses have been subtracted from all measured results.  $OIP_3$  value depends on termination of all intermodulation frequency components. Termination used for this measurement is  $50 \Omega$  from 0.2 MHz to 12 GHz.

**Electrical characteristics**

**3.4 Characteristic DC diagrams**

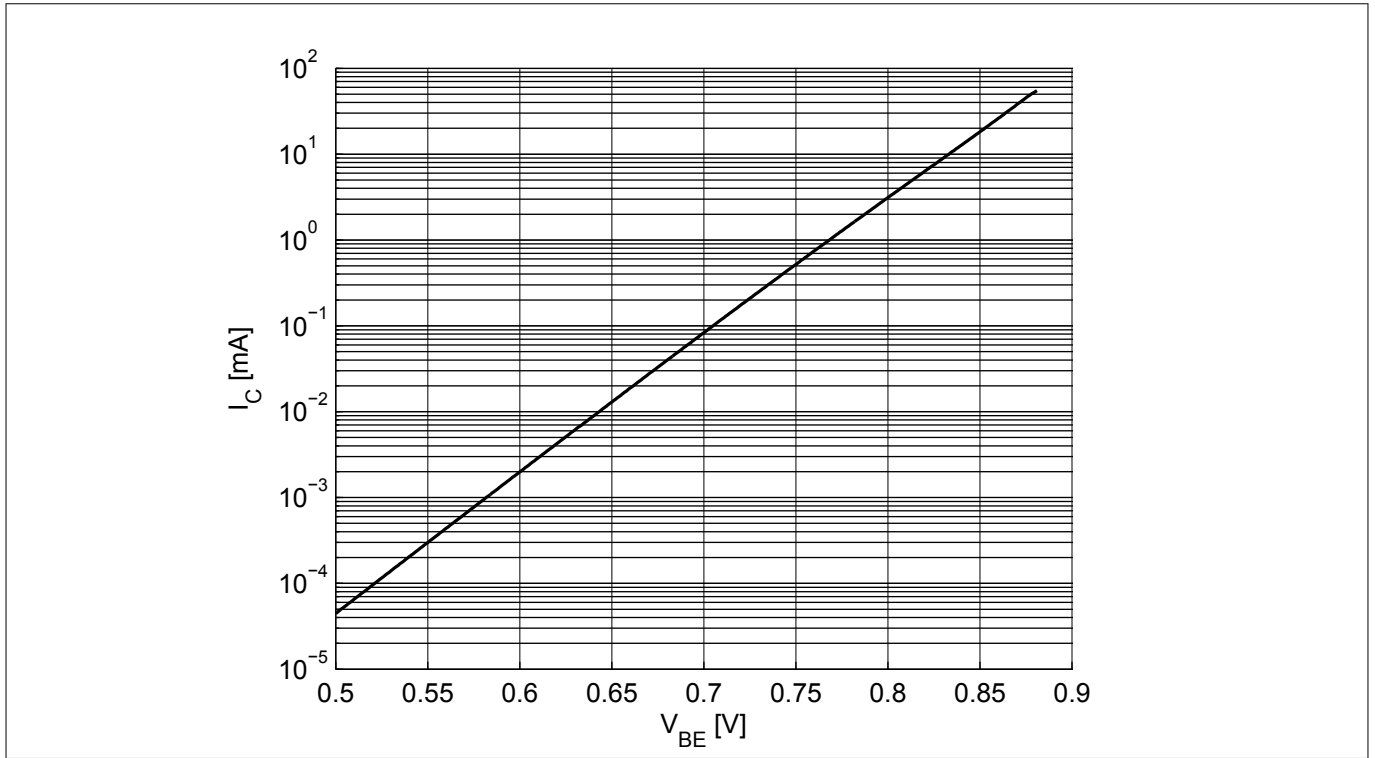


**Figure 3** Collector current vs. collector emitter voltage  $I_C = f(V_{CE})$ ,  $I_B = \text{parameter}$

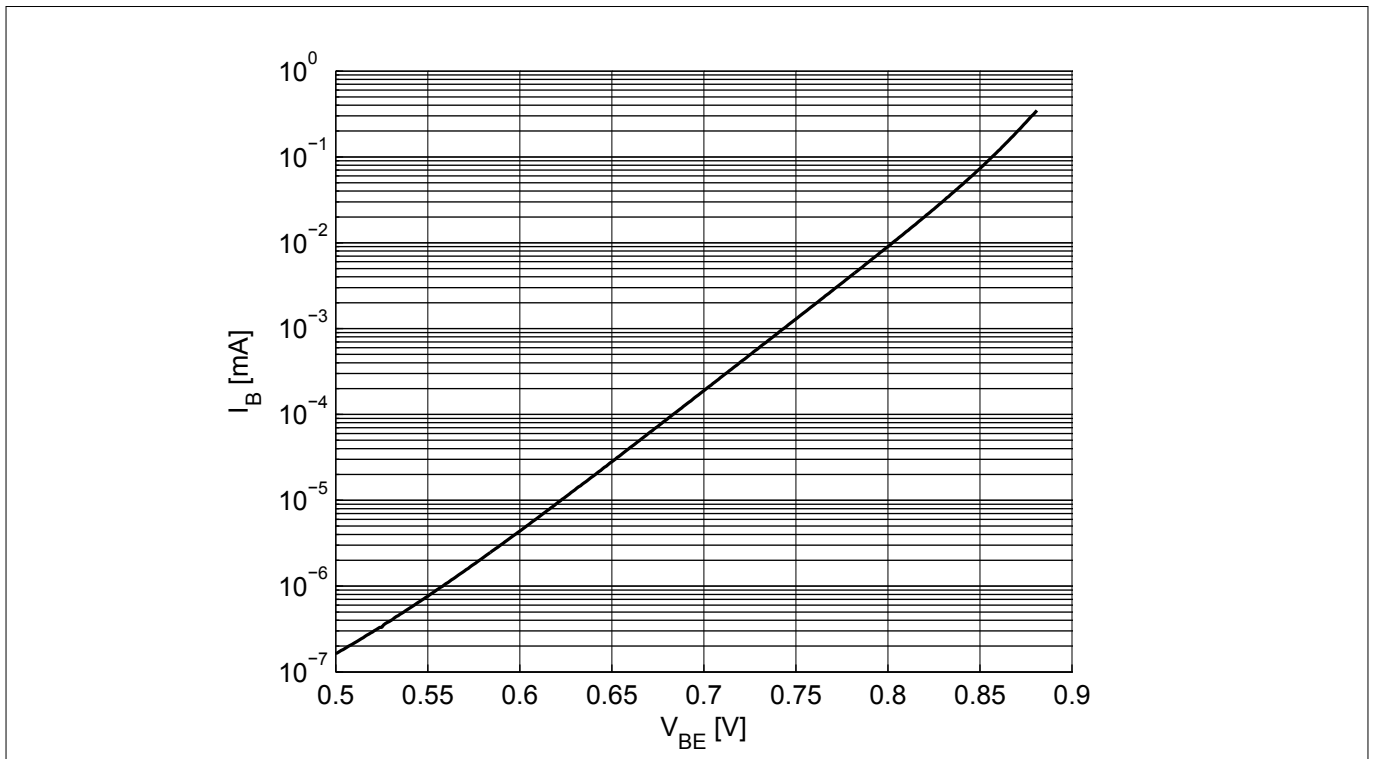


**Figure 4** DC current gain  $h_{FE} = f(I_C)$ ,  $V_{CE} = 1.8 \text{ V}$

**Electrical characteristics**

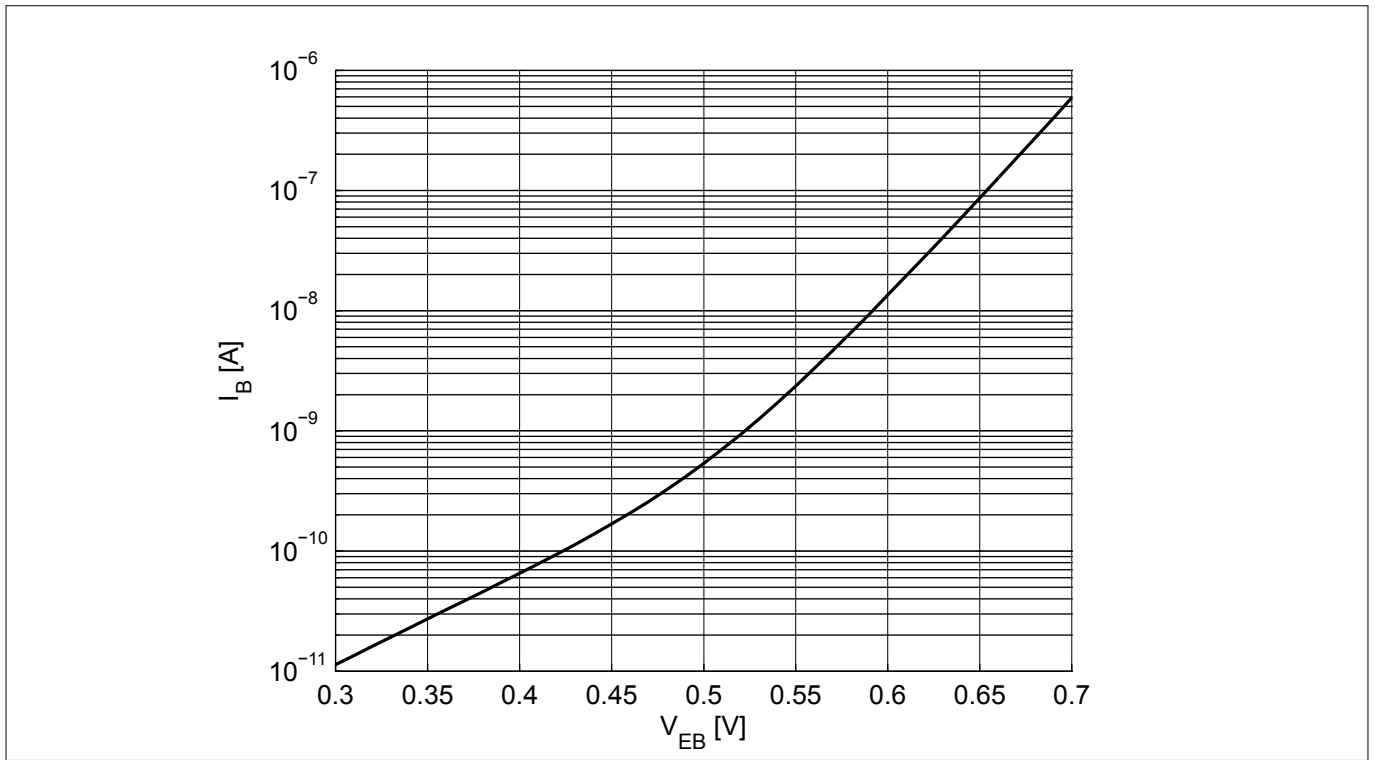


**Figure 5** Collector current vs. base emitter forward voltage  $I_C = f(V_{BE})$ ,  $V_{CE} = 1.8$  V



**Figure 6** Base current vs. base emitter forward voltage  $I_B = f(V_{BE})$ ,  $V_{CE} = 1.8$  V

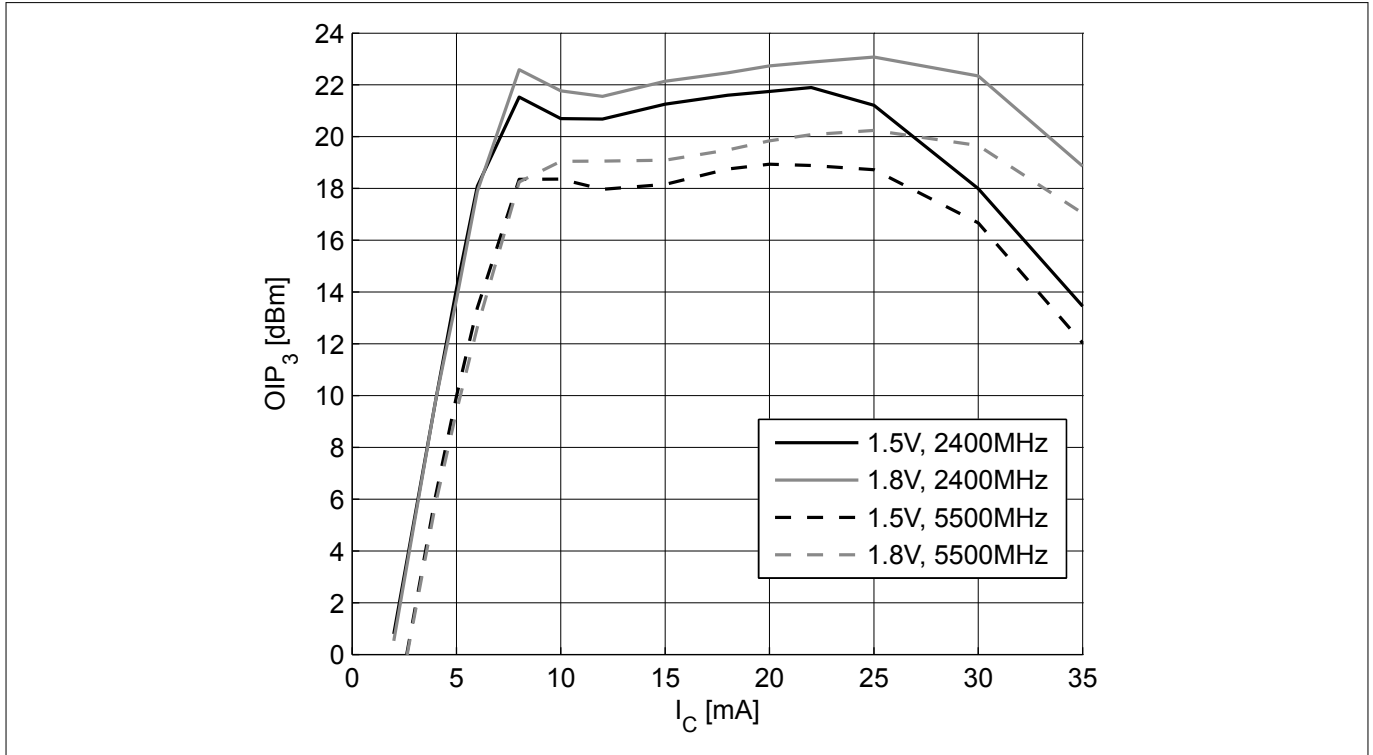
**Electrical characteristics**



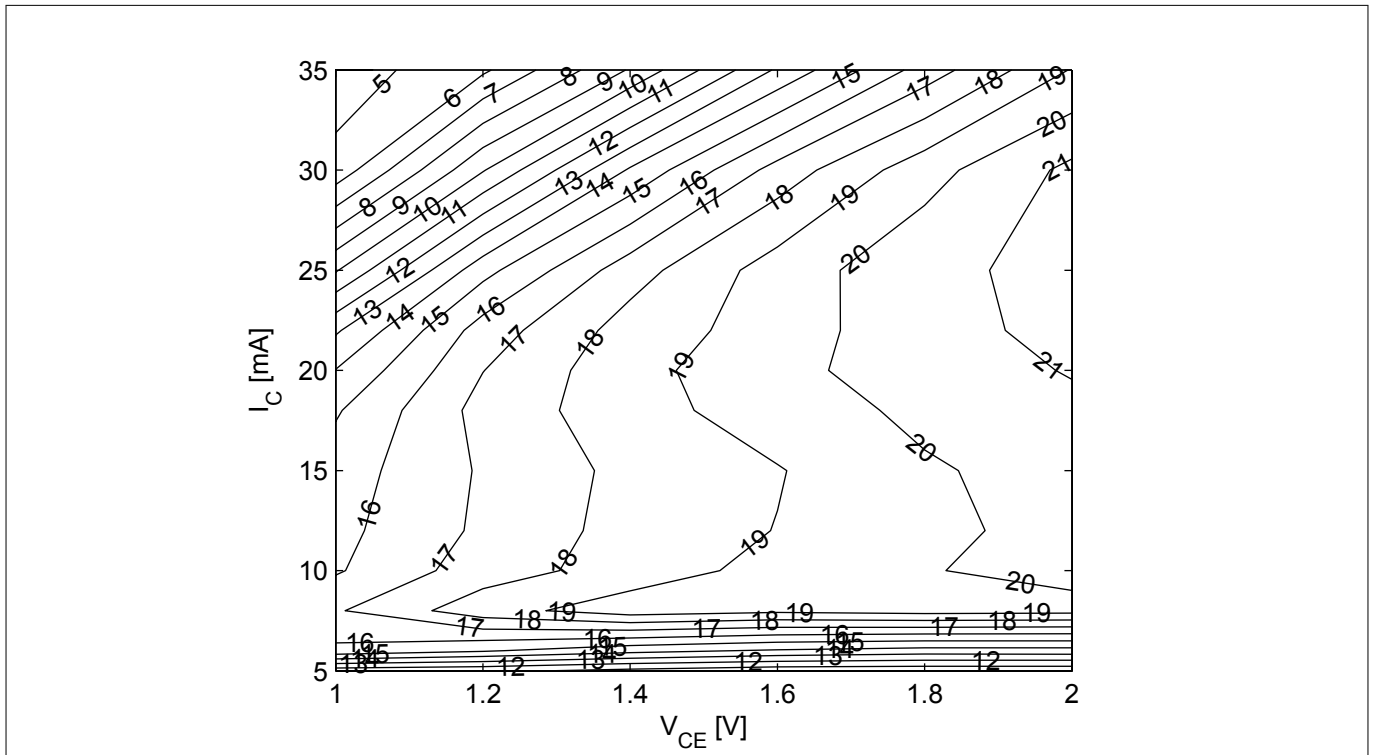
**Figure 7** Base current vs. base emitter reverse voltage  $I_B = f(V_{EB}), V_{CE} = 1.8$  V

**Electrical characteristics**

**3.5 Characteristic AC diagrams**

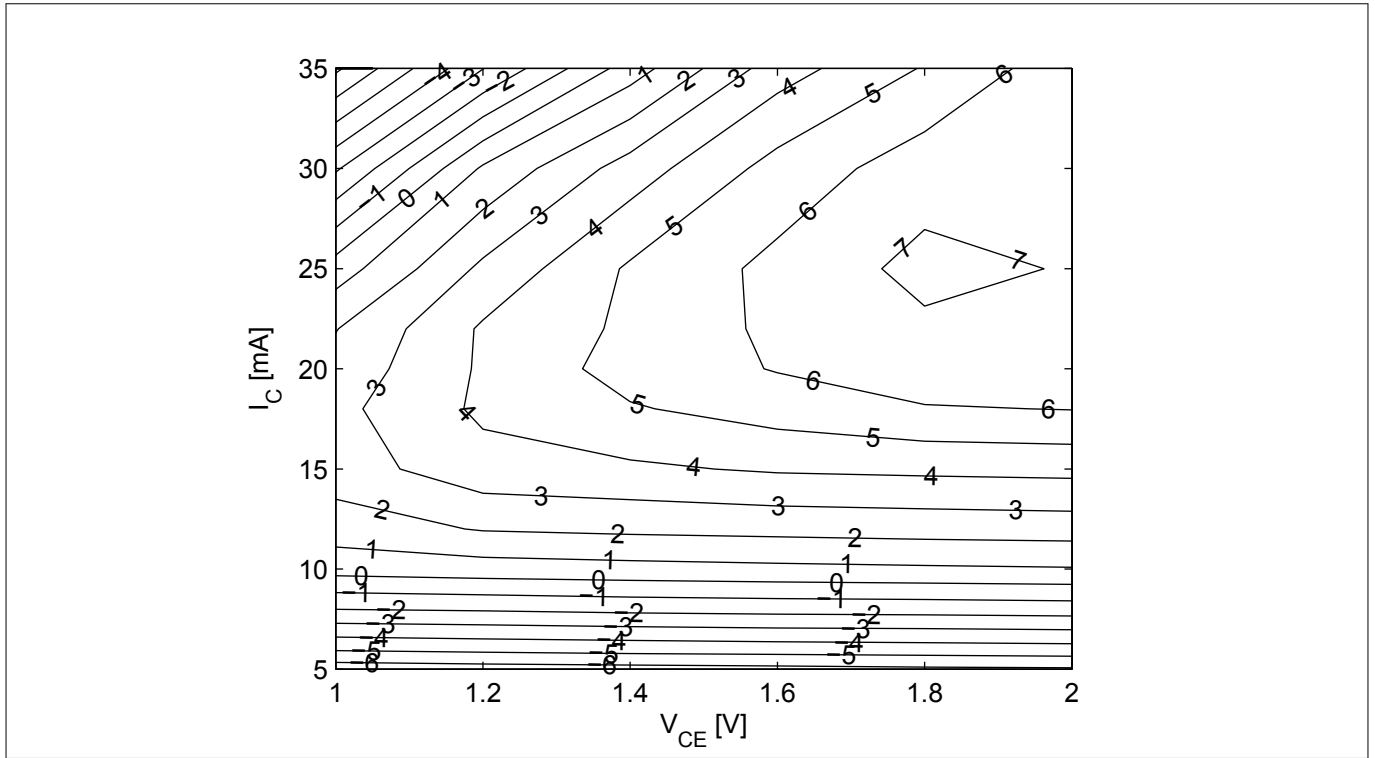


**Figure 8** 3rd order intercept point at output  $OIP_3 = f(I_C)$ ,  $Z_S = Z_L = 50 \Omega$ ,  $V_{CE}$ ,  $f =$  parameters

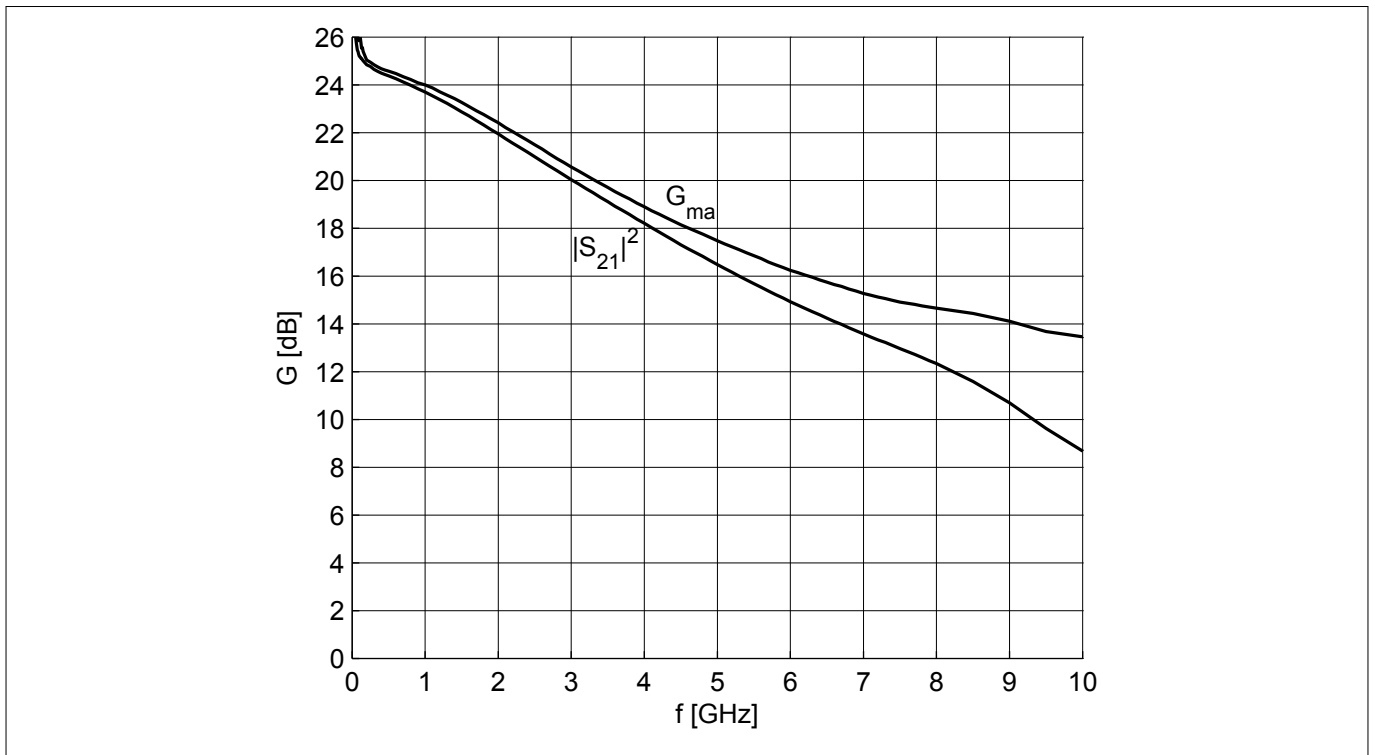


**Figure 9** 3rd order intercept point at output  $OIP_3 [dBm] = f(I_C, V_{CE})$ ,  $Z_S = Z_L = 50 \Omega$ ,  $f = 5.5 \text{ GHz}$

**Electrical characteristics**



**Figure 10** Compression point at output  $OP_{1dB} [dBm] = f(I_C, V_{CE})$ ,  $Z_S = Z_L = 50 \Omega$ ,  $f = 5.5 \text{ GHz}$



**Figure 11** Gain  $G_{ma}$ ,  $|S_{21}|^2 = f(f)$ ,  $V_{CE} = 1.8 \text{ V}$ ,  $I_C = 15 \text{ mA}$

Electrical characteristics

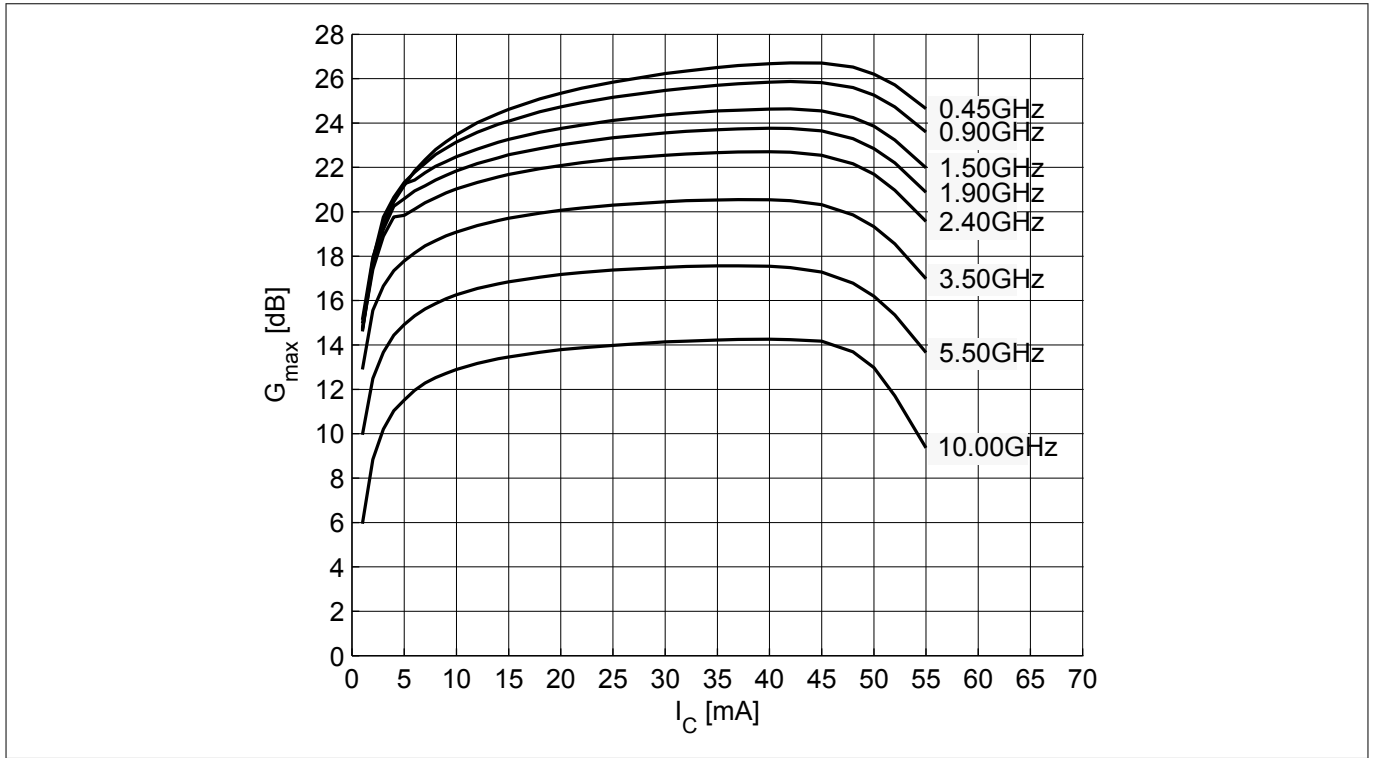


Figure 12 Maximum power gain  $G_{max} = f(I_C)$ ,  $V_{CE} = 1.8 V$ ,  $f =$  parameter in GHz

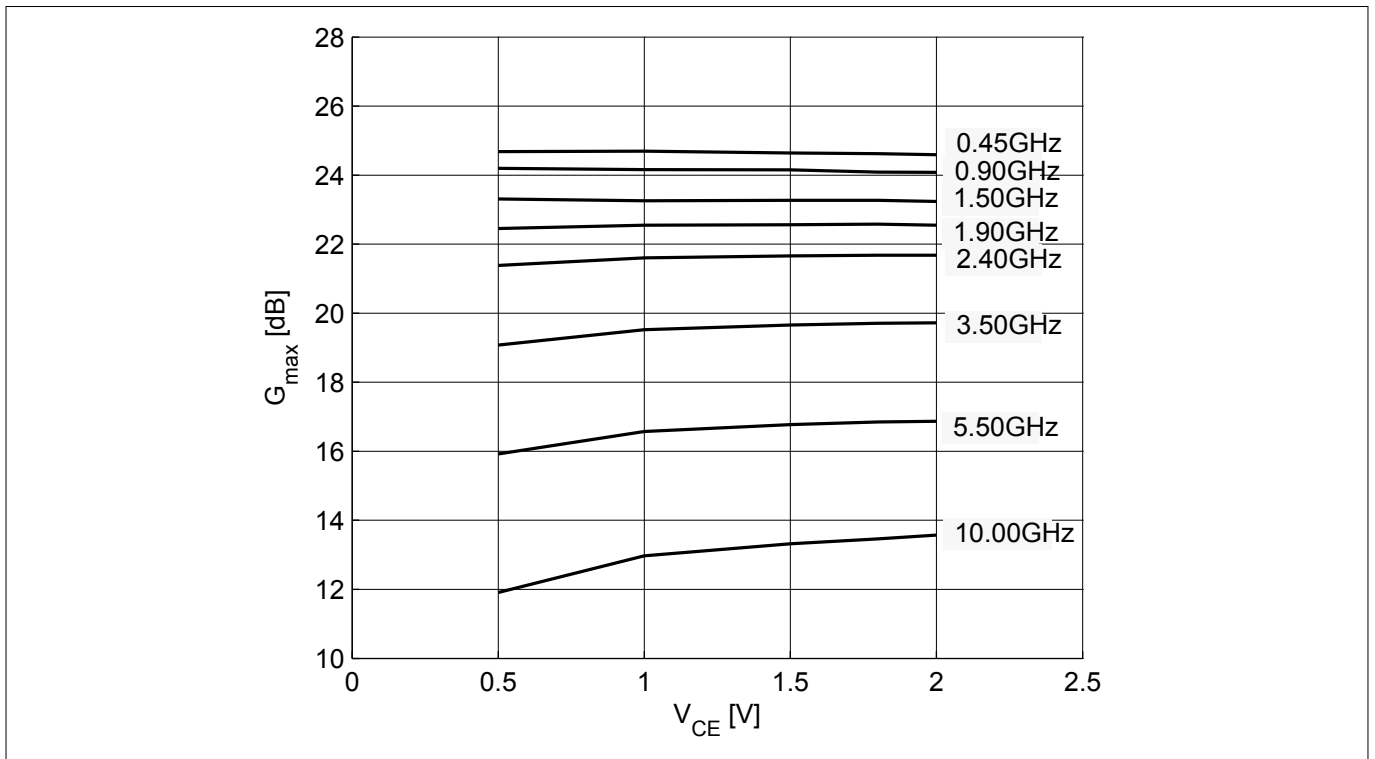
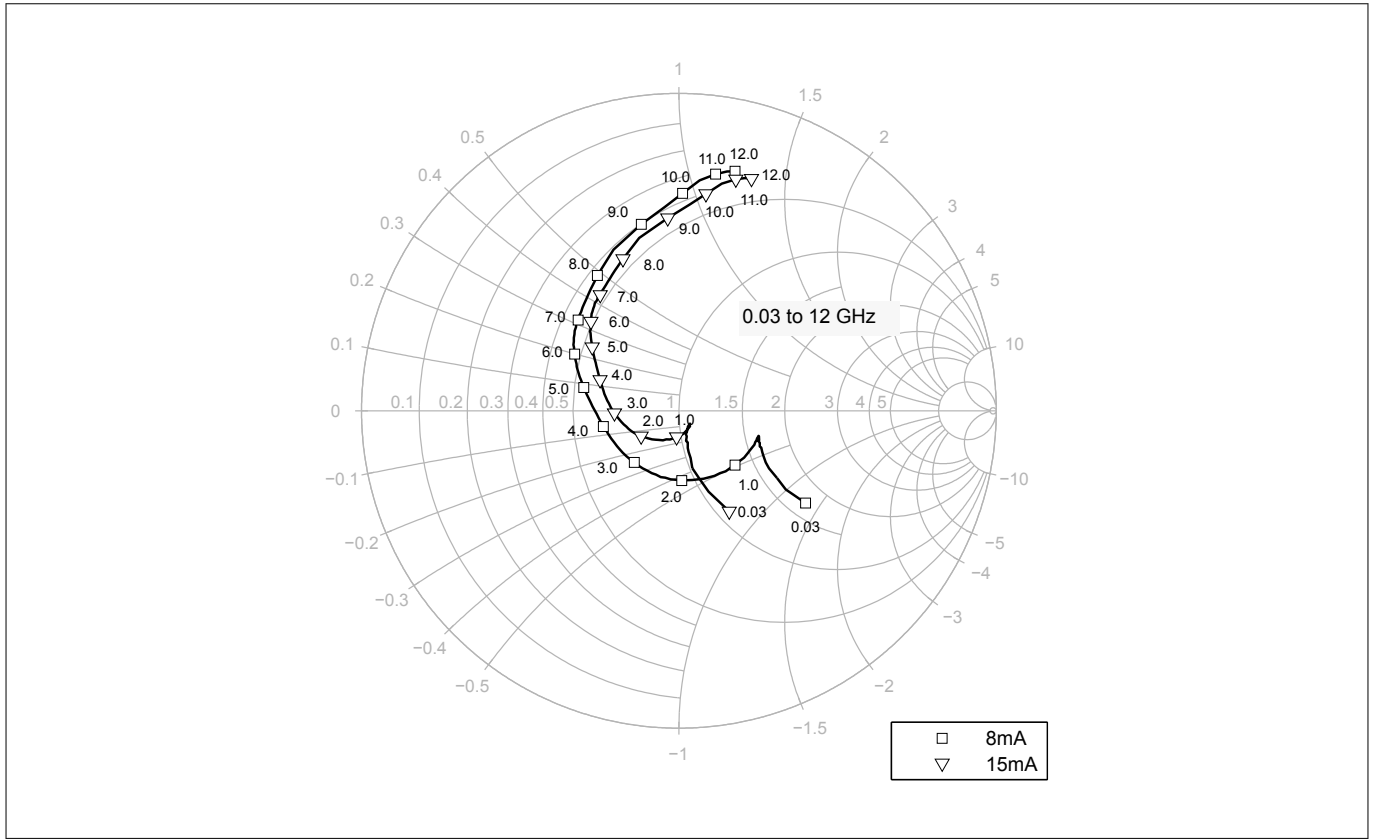
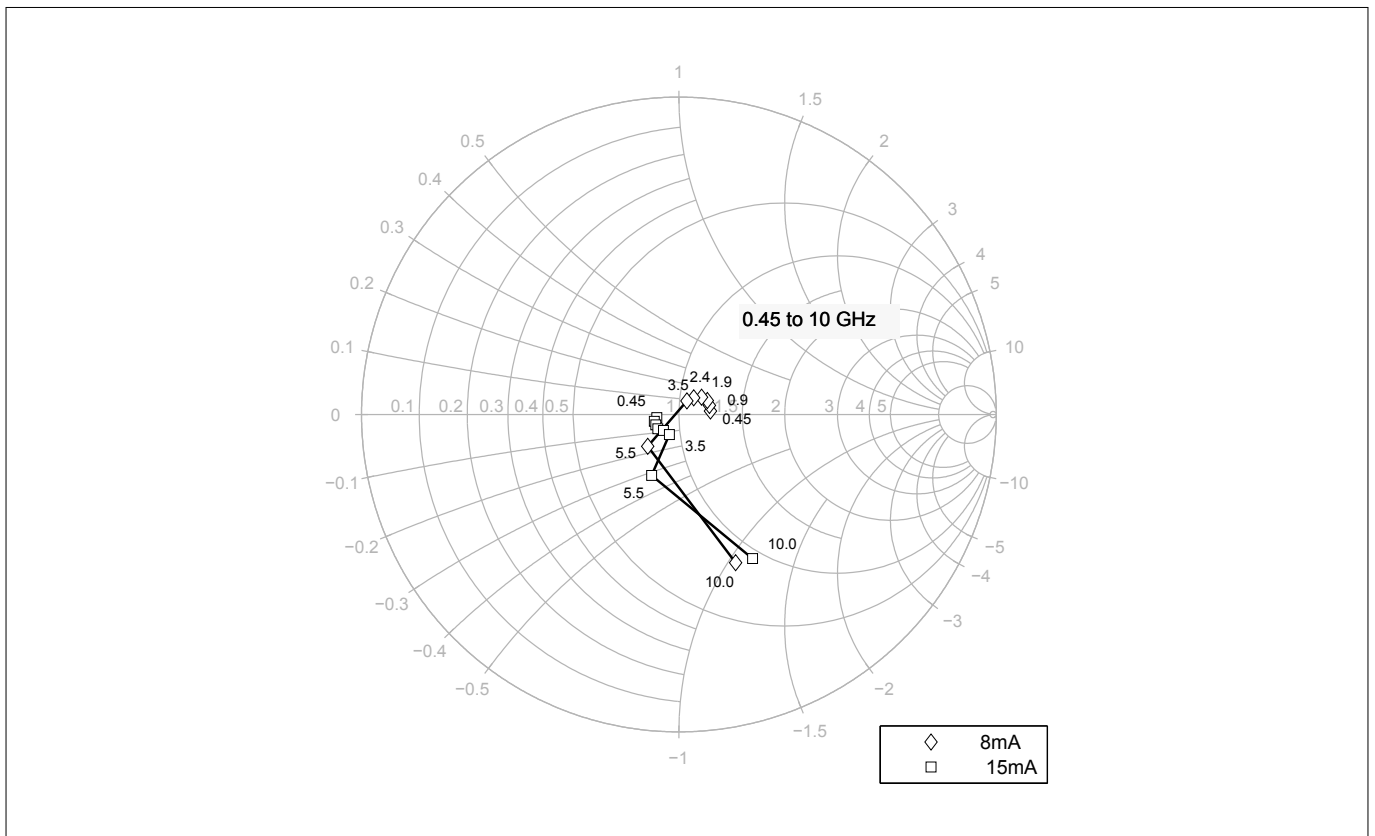


Figure 13 Maximum power gain  $G_{max} = f(V_{CE})$ ,  $I_C = 15 mA$ ,  $f =$  parameter in GHz

**Electrical characteristics**



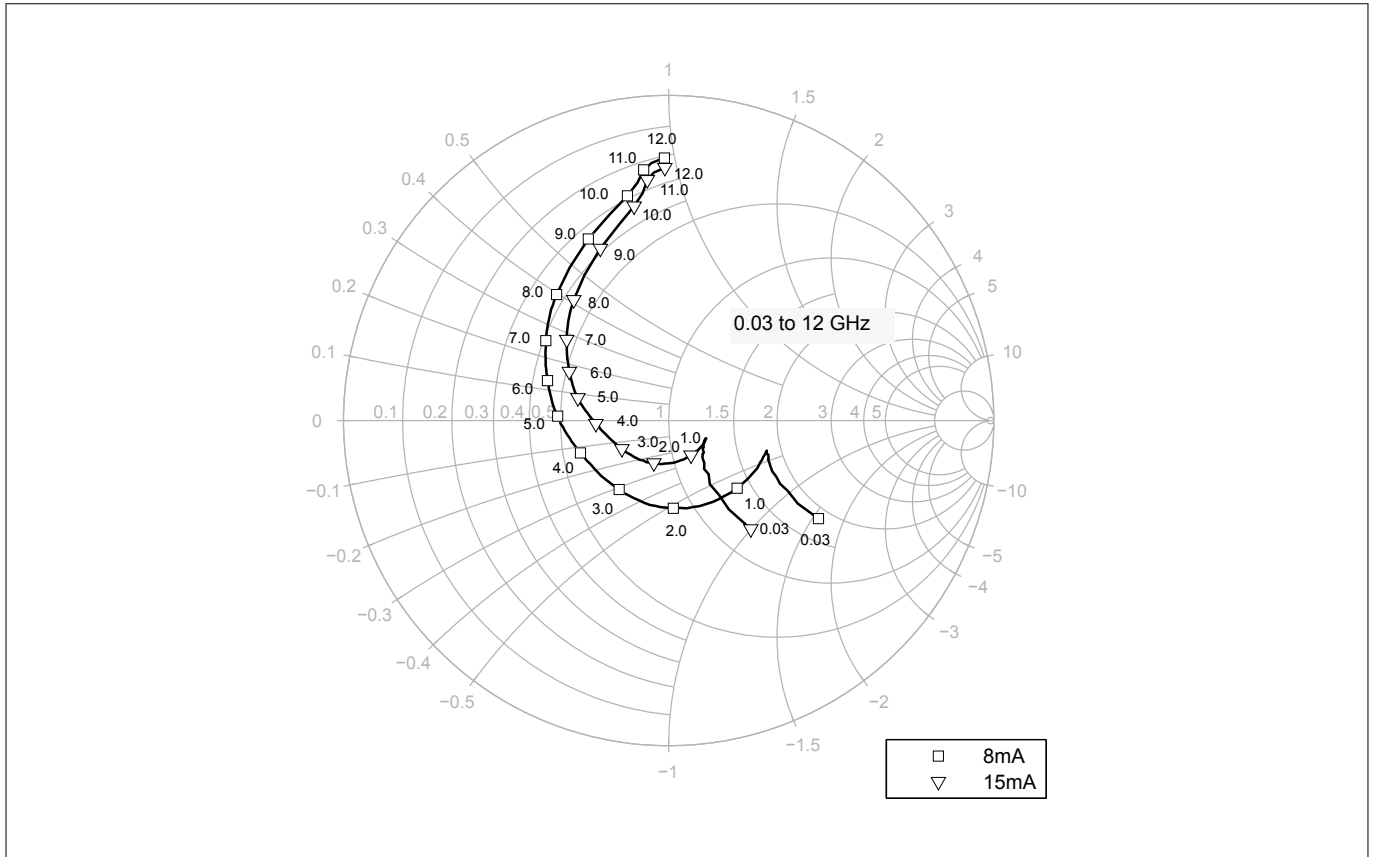
**Figure 14** Input reflection coefficient  $S_{11} = f(f)$ ,  $V_{CE} = 1.8\text{ V}$ ,  $I_C = 8 / 15\text{ mA}$



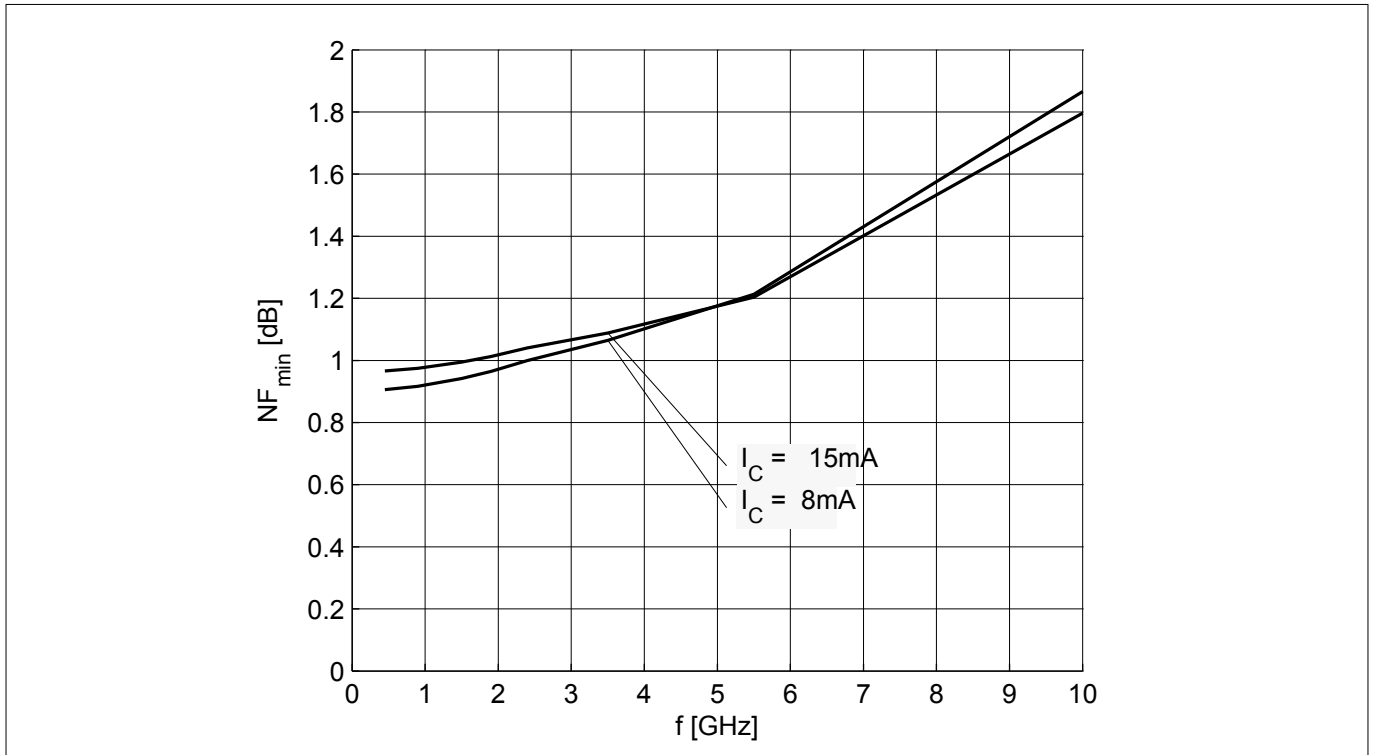
**Figure 15** Source impedance for minimum noise figure  $Z_{S,opt} = f(f)$ ,  $V_{CE} = 1.8\text{ V}$ ,  $I_C = 8 / 15\text{ mA}$



**Electrical characteristics**

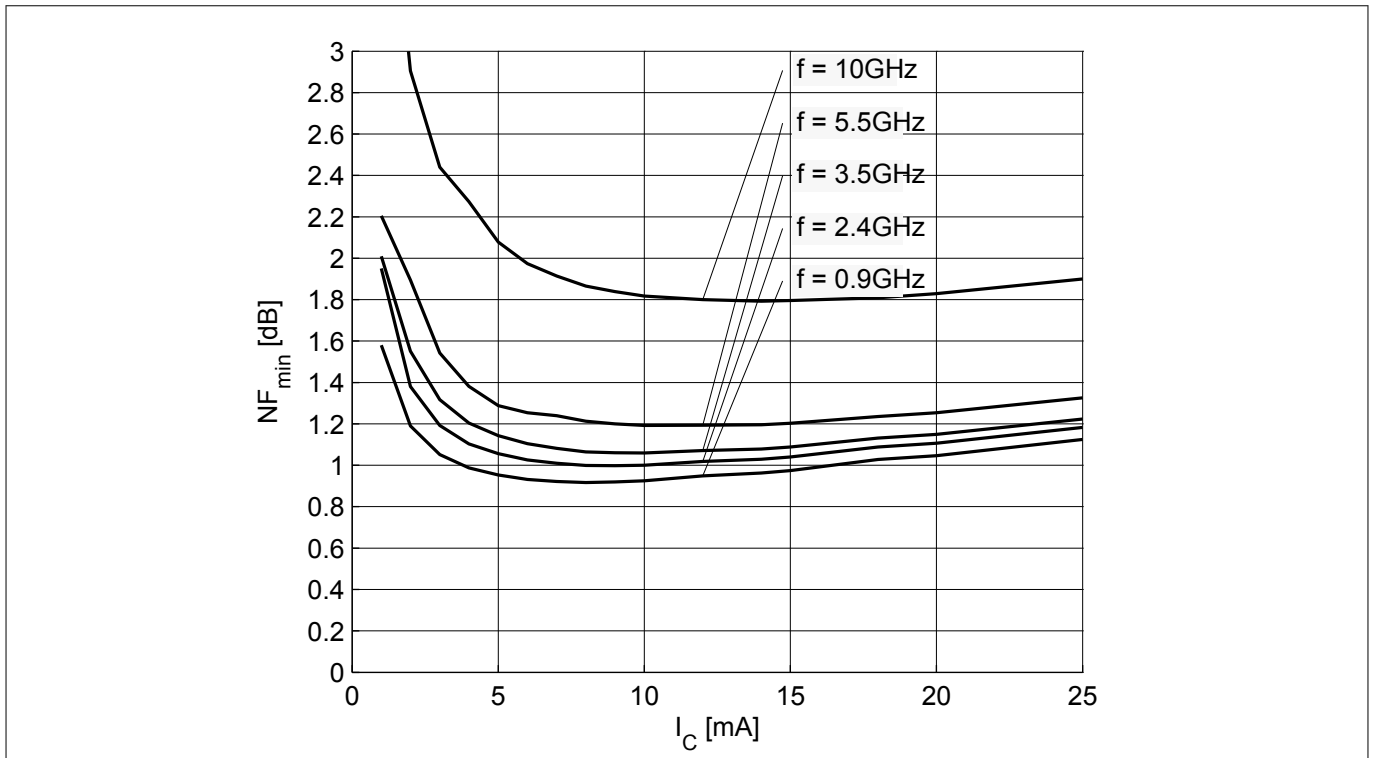


**Figure 16** Output reflection coefficient  $S_{22} = f(f)$ ,  $V_{CE} = 1.8 \text{ V}$ ,  $I_C = 8 / 15 \text{ mA}$

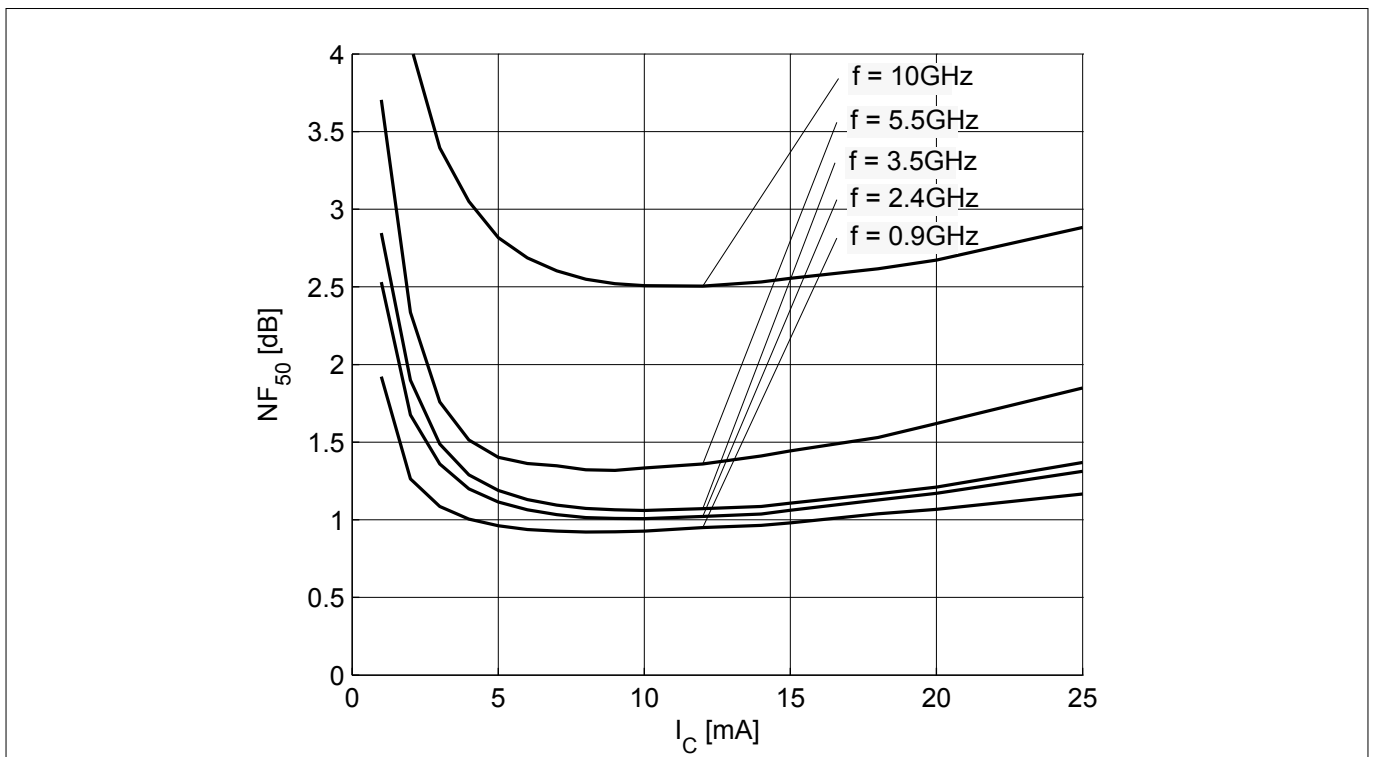


**Figure 17** Noise figure  $NF_{min} = f(f)$ ,  $V_{CE} = 1.8 \text{ V}$ ,  $Z_S = Z_{S,opt}$ ,  $I_C = 8 / 15 \text{ mA}$

**Electrical characteristics**



**Figure 18** Noise figure  $NF_{min} = f(I_C)$ ,  $V_{CE} = 1.8\text{ V}$ ,  $Z_S = Z_{S,opt}$ ,  $f = \text{parameter in GHz}$



**Figure 19** Noise figure  $NF_{50} = f(I_C)$ ,  $V_{CE} = 1.8\text{ V}$ ,  $Z_S = 50\ \Omega$ ,  $f = \text{parameter in GHz}$

*Note:* The curves shown in this chapter have been generated using typical devices but shall not be considered as a guarantee that all devices have identical characteristic curves.  $T_A = 25\text{ }^\circ\text{C}$ .



---

**Revision history****Revision history**

<b>Document version</b>	<b>Date of release</b>	<b>Description of changes</b>
2.0	2018-26-09	New datasheet layout.